



Tools cut better with TIGRA

Edition **2011**



Woodworking



Holzbearbeitung



Travail du bois



Lavorazione del legno



Trabajo de madera







**TIGRA**

-  This is TIGRA
-  Das ist TIGRA
-  C'est TIGRA
-  Questo è TIGRA
-  Esto es TIGRA





# Tools cut better with TIGRA

## **TIGRA – A family owned company with tradition and visions**

Since 1983, TIGRA has served the market with cutting materials for woodworking tools with the world's most comprehensive product range today.

The many years of experience in the production of tungsten carbide, ongoing research and development, as well as a completely automated production and quality control ensure that TIGRA competitively offers the best quality in short delivery time. With the production in Oberndorf am Lech, Germany, and sales offices in the USA, Brazil and China customers receive competent service in 80 countries.

Besides the large selection of carbide for woodworking, metal working and working of composite materials as well as wear parts TIGRA has consistently been working on further cutting materials, so that today not only about 20 carbide grades, but also PCD, PcBN, HSS, TIGRAIloy and coatings, complete the unique product range.

Whether standard or special articles: TIGRA is your partner for solutions in tungsten carbide and ultra-hard cutting materials.

As a family owned company we feel obligated to our customers and are constantly working to be innovative and strike a new path, but also to offer you a program tailored to your needs.



## **TIGRA – ein Familienunternehmen mit Tradition und Weitsicht**

Seit 1983 bedient TIGRA den Markt für Schneidstoffe für Holzbearbeitungswerkzeuge mit dem heute weltweit umfassendsten Produktspektrum.

Die langjährige Erfahrung in der Herstellung von Hartmetall, permanente Forschung und Entwicklung, sowie eine durchgängig automatisierte Produktion und Qualitätskontrolle garantieren, dass TIGRA beste Qualität wettbewerbsfähig und mit kurzen Lieferterminen anbietet. Mit der Produktion in Oberndorf am Lech in Bayern und Verkaufsniederlassungen in den USA, Brasilien und China werden Kunden in 80 Ländern kompetent bedient.

Neben der großen Auswahl an Hartmetall für die Bearbeitung von Holz, Metall und Verbundwerkstoffen sowie Verschleißteilen wurde konsequent auch an weiteren Schneidstoffen gearbeitet, so dass heute nicht nur über 20 Hartmetallsorten, sondern auch PKD, PcBN, HSS, TIGRAIloy und Beschichtungen das einzigartige Lieferprogramm abrunden.

Ob Standard- oder Sonderartikel: TIGRA ist Ihr Ansprechpartner für Lösungen aus Hartmetall und ultraharten Schneidstoffen.

Als Familienunternehmen fühlen wir uns unseren Kunden verpflichtet und arbeiten ständig daran, innovative Wege zu beschreiten und Ihnen ein auf Ihre Bedürfnisse maßgeschneidertes Programm zu bieten.

## **TIGRA - une entreprise familiale de tradition de grande envergure**

Depuis 1983, TIGRA approvisionne le marché des matières de coupe par des outils à bois constituant aujourd'hui la gamme de produits la plus complète au monde.

Les nombreuses années d'expérience dans la fabrication du métal dur, la recherche et le développement permanents, la production entièrement automatisée et le contrôle de qualité assurent à TIGRA d'offrir la meilleure qualité compétitive et des délais de livraison brefs. Avec la production à Oberndorf am Lech, en Allemagne, et des points de vente aux États-Unis, au Brésil et en Chine, TIGRA approvisionne avec compétence les clients dans 80 pays.

Outre le grand choix de métal dur pour le traitement du bois, du métal et des matériaux composites ainsi que des pièces d'usure, nous avons aussi travaillé de manière conséquente à d'autres matières de coupe, si bien qu'aujourd'hui non seulement 20 types de métal dur, mais encore des PCD, PcBN, HSS, TIGRAIloy et des revêtements complètent l'assortiment unique de produits.

Qu'il s'agisse d'articles standards ou spéciaux, TIGRA est votre interlocuteur pour les solutions de métal dur et de matières de coupe ultra-dures.

En tant qu'entreprise familiale, nous nous sentons obligés envers nos clients et recherchons ainsi sans cesse des voies innovantes afin de vous offrir un programme sur mesure répondant à vos besoins.

## **TIGRA - un' Azienda a conduzione familiare con alte tradizioni**

Dal 1983 TIGRA è presente sul mercato con strumenti di taglio per la lavorazione del legno. Attualmente abbiamo la gamma di prodotti più completa al mondo.

Molti anni di esperienza nella produzione di metallo duro, ricerche e sviluppi continui, produzione e controllo di qualità completamente automatizzati. Tutto questo assicura che TIGRA offre la migliore qualità e competitività con tempi di consegna brevi. Con



la producción a Oberndorf am Lech in Alemania e uffici commerciali negli Stati Uniti, Brasile e Cina siamo fornitori competenti per clienti in 80 paesi diversi.

Oltre alla vasta scelta di metallo duro per la lavorazione del legno, metallo e materiali compositi come anche prodotti di usura, abbiamo lavorato costantemente su ulteriori materiali da taglio. Questo ci porta a una gamma unica di prodotti con, non solo 20 tipi di metallo duro, ma anche con PCD, PcBN, HSS, TIGRAloy e rivestimenti.

Articoli standard o speciali: TIGRA è il vostro partner per soluzioni di metallo duro e materiali da taglio ultra duri.

Come azienda a conduzione familiare ci sentiamo responsabili verso i nostri clienti e lavoriamo costantemente a innovazioni per offrire programmi su misura che coprono le Vostre esigenze.

### **TIGRA - una empresa familiar tradicional y visionaria**

Desde 1983 TIGRA viene sirviendo al mercado de los materiales cortantes para herramientas de corte de madera y dispone actualmente de la gama de productos más exhaustiva del mundo.





Los largos años de experiencia en la producción de metal duro, la permanente labor de investigación y desarrollo, la producción totalmente automatizada y los controles de la calidad avalan la óptima calidad y competitividad de los productos TIGRA así como plazos de entrega cortos. Con la producción en Oberndorf am Lech, Alemania, y filiales en los EE.UU., Brasil y China, TIGRA ofrece a sus clientes un servicio competente en 80 países.





Además de la gran selección de metal duro para el procesamiento de la madera, metal, materiales compuestos y piezas de desgaste, se ha trabajado constantemente en otros materiales de corte, para que el programa actual no sólo incluya 20 clases de carburo, sino también PCD, PcBN, HSS, TIGRAloy y revestimientos.

TIGRA es el socio ideal para soluciones en metal duro y materiales de corte ultraduros, tanto en versión estándar como especial.

Como empresa familiar nos sentimos obligados a ofrecer soluciones que aporten un valor añadido a nuestros clientes y luchamos por brindarles un programa de productos innovadores e individuales que satisfaga plenamente sus necesidades.



-  **TIGRA carbide grades and their applications – Technical Data**
-  **TIGRA Hartmetallsorten und ihre Anwendungen – Technische Daten**
-  **Les nuances de carbures TIGRA et leurs applications – Caractéristiques techniques**
-  **I tipi di metallo duro TIGRA e le loro applicazioni – Dati tecnici**
-  **Calidades de metal duro TIGRA y sus aplicaciones – Datos técnicos**

 TIGRA grade  TIGRA - Sorte  Nuance TIGRA  Tipo TIGRA  Calidad TIGRA	Binder		Hardness		Bending strength		Toughness
	Binder	Liant	Härte	Dureté	Biegebruchfestigkeit	Resistance à la flexion	Zähigkeit
	Legante	Durezza	Durezza	Resistenza flessionale	Resistencia a la flexión	Tenacità	Tenacidad
	Composicion	Durezza					
	%	HV 10	HRA ± 0.2	N/mm <sup>2</sup>	psi	K <sub>1C</sub> / MPa.m <sup>-1/2</sup>	
<b>T02UMG</b> ISO: K01 USA: C4 +++	2.0	2550	> 95.5	2300	334.000	5.4	
<b>T02SMG</b> ISO: K01 USA: C4 +++	2.5	2350	95.3	2000	290.000	5.7	
<b>T03SMG</b> ISO: K01 USA: C4 ++	3.5	2100	94.6	2400	348.000	6.4	
<b>T05CR*</b> ISO: K01 USA: C4 ++	3.0	2100	94.6	2500	363.000	6.9	
<b>T06CR*</b> ISO: K01 USA: C4 +	3.0	1950	94.0	2300	334.000	8.2	
<b>T08CR*</b> ISO: K01 USA: C4 +	4.3	1900	93.6	2350	341.000	8.5	
<b>T04F</b> ISO: K05 USA: C4	4.0	1750	92.8	2350	341.000	8.6	
<b>T05UMG</b> ISO: K01-K10 USA: C3 ++	5.0	2050	94.5	2450	355.000	6.9	
<b>T06F</b> ISO: K10 USA: C3	6.0	1740	92.7	2350	341.000	9.0	
<b>T06M</b> ISO: K20 USA: C3 -	6.5	1400	90.3	2400	348.000	10.4	
<b>T06MF</b> ISO: K20 USA: C2	6.5	1600	92.0	2500	363.000	9.9	
<b>T06MG</b> ISO: K01-K20 USA: C3 ++	6.0	1800	93.3	2700	392.000	8.2	
<b>T08MF</b> ISO: K30 USA: C2	8.5	1470	90.9	2700	392.000	10.3	
<b>T08SMG</b> ISO: K05-K30 USA: C2 +++	9.0	1750	92.8	3400	493.000	8.4	
<b>T10MG</b> ISO: K10-K40 USA: C3 +	10.0	1650	92.3	3600	522.000	9.4	
<b>T12SMG</b> USA: C1 ++	12.0	1700	92.7	4000	580.000	9.2	
<b>T12M</b> ISO: > K40 USA: C1	12.0	1250	88.7	2800	406.000	14.0	
<b>T15C</b> ISO: > K40 USA: Nail Cut	15.0	890	84.5	3000	435.000	> 20	
<b>TL15*</b>	13.5	1450	90.7	3800	551.000	10.5	
<b>TL20*</b>	20.0	1400	90.3	3800	551.000	12.0	





\* Special binder - Spezialbinder - Liant spécial - Legante speciale - Composición especial





-  **TIGRA carbide grades and their applications – Grain sizes and binder content**
-  **TIGRA Hartmetallsorten und ihre Anwendungen – Korngrößen und Bindergehalt**
-  **Les nuances de carbures TIGRA et leurs applications – Grosseur du grain et contingent de liant**
-  **I tipi di metallo duro TIGRA e le loro applicazioni – Grossezza del grano e quota di legante**
-  **Calidades de metal duro TIGRA y sus aplicaciones – Tamaño del grano y cuota de la composición**

 Shortform  Abkürzung  Abréviation  Abbreviazione  Abreviatura	Explanation Erklärung Explication Spiegazione Spiegazione	Grain size Korngröße Grosseur du grain Grossezza del grano Tamaño del grano  <div style="background-color: red; color: white; text-align: center; padding: 2px;"><b>µm</b></div>	
<b>NG</b>	Nano Grain	0.2	
<b>UMG</b>	Ultra Micro Grain	0.2 - 0.5	
<b>SMG</b>	Sub Micro Grain	0.5 - 0.7	
<b>MG</b>	Micro Grain	0.7 - 1.0	
<b>F</b>	Fine Grain	1.0 - 1.4	
<b>MF</b>	Medium Fine Grain	1.4 - 2.5	
<b>M</b>	Medium Grain	2.5 - 4.0	
<b>C</b>	Coarse Grain	4.0 - 10.0	
<b>EC</b>	Extra Coarse	> 10	

-  For best performance, grade compositions may slightly vary in the different product groups.
-  Für optimale Ergebnisse können die Sortenzusammensetzungen in den verschiedenen Produktgruppen leicht variieren.
-  Les compositions des types présents dans les différents groupes de produits peuvent légèrement varier pour des résultats optimaux.
-  Per ottenere migliori prestazioni le composizioni e il grado possono variare leggermente in alcuni gruppi di prodotti.
-  Para avarar óptimos resultados, es probable que las composiciones de los diversos grupos de productos varíen ligeramente.





**TIGRA**

 This is TIGRA

 Das ist TIGRA

 C'est TIGRA

 Questo è TIGRA





 Esto es TIGRA









# Contents Inhalt Sommaire Indice Índice







-  Reversible knives and edge rounding knives
-  Wendschneidplatten und Kantenrunder
-  Plaquettes reversibles et couteaux brise-arrête
-  Coltelli reversibili e spigolatori
-  Cuchillas reversibles y cuchillas para aristas







-  Blanks for profiling and radius knives
-  Blanketts zum Profilieren und Radienplatten
-  Plaquettes à profiler et plaquettes profilées
-  Placchette da profilare e placchette profilate
-  Placas para perfilar y perfiladas



-  Saw tips and strobe blanks
-  Sägezähne und Wischerblätter
-  Dents de scie et racleurs
-  Dentelli per lame e barrette per rasanti
-  Dientes de sierra y rasuradores







-  Carbide for brazed tools
-  Hartmetall für gelötete Fräser
-  Plaquettes en carbure à braser
-  Metallo duro per frese saldobrasate
-  Metal duro para herramienta soldada

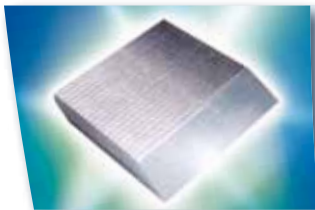

-  Planer knives
-  Hobelmesser
-  Couteaux à raboter
-  Coltelli da pialla
-  Cuchillas para cepilar







-  Knives for back corrugated cutterheads
-  Messer für rückenverzahnte Messerköpfe
-  Couteaux pour outils crantés
-  Coltelli per teste con zigrinatura
-  Cuchillas corrugadas



-  Rods
-  Rundstäbe
-  Barreaux cylindriques
-  Cilindri
-  Barras redondas



-  PCD - Polycrystalline diamond
-  PKD - Polykristalliner Diamant
-  PCD - Diamant policristallin
-  PCD - Diamante policristallino
-  PCD - Diamante policristalino









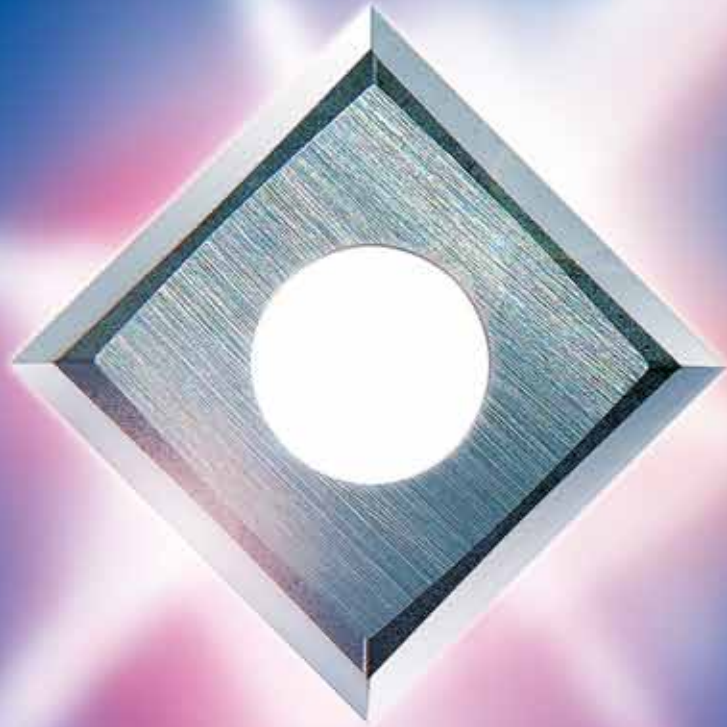





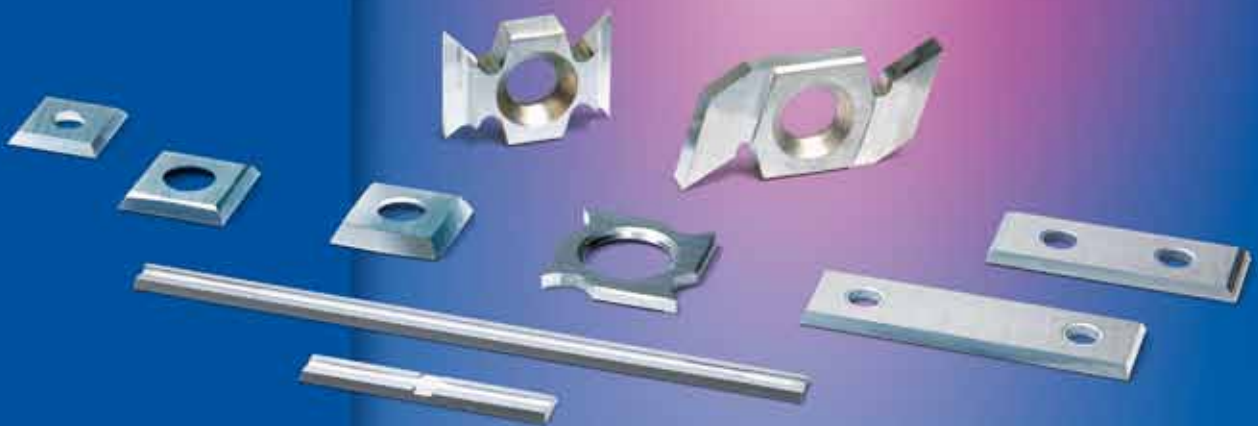

**Tools cut better  
with TIGRA**







-  **Reversible knives and edge rounding knives**
-  **Wendeschneidplatten und Kantenrunder**
-  **Plaquettes reversibles et couteaux brise-arrête**
-  **Coltelli reversibili e spigolatori**
-  **Cuchillas reversibles y cuchillas para aristas**







-  **Reversible knives - TIGRA carbide grades and their applications** – Technical Data
-  **Wendeschneidplatten - TIGRA Hartmetallsorten und ihre Anwendungen** – Technische Daten
-  **Plaquettes reversibles - Les nuances de carbures TIGRA et leurs applications** – Caractéristiques techniques
-  **Coltelli reversibili - I tipi di metallo duro TIGRA e le loro applicazioni** – Dati tecnici
-  **Cuchillas reversibles - Calidades de metal duro TIGRA y sus aplicaciones** – Datos técnicos

 TIGRA grade  TIGRA - Sorte  Nuance TIGRA  Tipo TIGRA  Calidad TIGRA	Binder	Hardness		Bending strength		Toughness
	Binder Liant Legante Composicion	Härte Dureté Durezza Durezza		Biegebruchfestigkeit Resistance à la flexion Resistenza flessionale Resistencia a la flexión		Zähigkeit Ténacité Tenacità Tenacidad
	%	HV 10	HRA ± 0.2	N/mm <sup>2</sup>	psi	K <sub>1C</sub> / MPa.m <sup>-1/2</sup>
<b>T02UMG</b> ISO: K01 USA: C4 +++	2.0	2550	> 95.5	2300	334.000	5.4
<b>T02SMG</b> ISO: K01 USA: C4 +++	2.5	2350	95.3	2000	290.000	5.7
<b>T03SMG</b> ISO: K01 USA: C4 ++	3.5	2100	94.6	2400	348.000	6.4
<b>T04F</b> ISO: K05 USA: C4	4.0	1750	92.8	2350	341.000	8.6
<b>T08CR*</b> ISO: K01 USA: C4 +	4.3	1900	93.6	2350	341.000	8.5
<b>T05UMG</b> ISO: K01-K10 USA: C3 ++	5.0	2050	94.5	2450	355.000	6.9
<b>T06M</b> ISO: K20 USA: C3 -	6.5	1400	90.3	2400	348.000	10.4
<b>T06MF</b> ISO: K20 USA: C3	6.5	1600	92.0	2500	363.000	9.9
<b>T06MG</b> ISO: K01-K20 USA: C3 ++	6.0	1800	93.3	2700	392.000	8.2
<b>T08MF</b> ISO: K30 USA: C2	8.5	1470	90.9	2700	392.000	10.3
<b>T08SMG</b> ISO: K05-K30 USA: C2 +++	9.0	1750	92.8	3400	493.000	8.4
<b>T10MG</b> ISO: K10-K40 USA: C3 +	10.0	1650	92.3	3600	522.000	9.4

\* Special binder - Spezialbinder - Liant special - Legante speciale - Composicion especial





 TIGRA grade  TIGRA - Sorte  Nuance TIGRA  Tipo TIGRA  Calidad TIGRA	HDF	MDF	Chipboard Spanplatte Panneaux de particule Truciolare Panel de aglomerado	Hardwood Hartholz Bois dur Legno duro Madera dura	Softwood Weichholz Bois tendre Legno tenero Madera blanda
<b>T02UMG</b>	+++	+++	+	--	--
<b>T02SMG</b>	++	+++	+++	-	--
<b>T03SMG</b>	+	++	+++	0	--
<b>T04F</b>	0	+	++	+	+
<b>T08CR*</b>	0	++	++	++	+
<b>T05UMG</b>	+	+	+	+++	+
<b>T06MF</b>	-	-	-	0	+
<b>T08MF</b>	-	-	-	+	+
<b>T10MG</b>	-	0	0	++	++











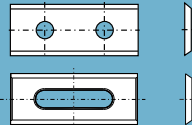





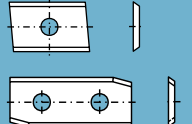





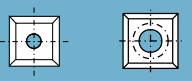





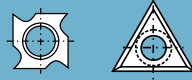











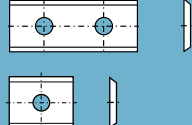





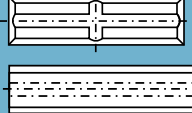





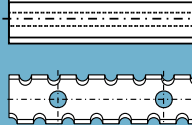





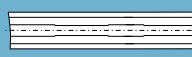

-  Reversible knives - TIGRA carbide grades and their applications
-  Wendschneidplatten - TIGRA Hartmetallsorten und ihre Anwendungen
-  Plaquettes reversibles - Les nuances de carbures TIGRA et leurs applications
-  Coltelli reversibili - I tipi di metallo duro TIGRA e le loro applicazioni
-  Cuchillas reversibles - Calidades de metal duro TIGRA y sus aplicaciones



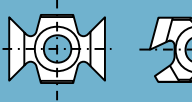

 TIGRA grade  TIGRA - Sorte  Nuance TIGRA  Tipo TIGRA  Calidad TIGRA	Main usage Hauptanwendung Principal usage Main uso Uso principal	
<b>T02UMG</b>	Standard reversible knives Standard-Wendschneidplatten Plaquettes reversibles standard Coltelli reversibili standard Cuchillas reversibles standard	
<b>T02SMG</b>	Standard reversible knives Standard-Wendschneidplatten Plaquettes reversibles standard Coltelli reversibili standard Cuchillas reversibles standard	
<b>T03SMG</b>	Standard and mini reversible knives Standard- und Mini-Wendschneidplatten Plaquettes reversibles standard et mini Coltelli reversibili standard e mini Cuchillas reversibles standard y mini	
<b>T04F</b>	Reversible knives - universal grade Wendschneidplatten - Universalsorte Plaquettes reversibles - nuance universelle Coltelli reversibili - metallo duro universale Cuchillas reversibles - calidad universal	
<b>T08CR</b>	Reversible knives, planer knives Wendschneidplatten, Hobelkopfplatten Plaquettes reversibles, couteaux pour outils à raboter Coltelli reversibili, coltelli per teste da pialla Cuchillas reversibles, cuchillas para cepillar	
<b>T05UMG</b>	Special reversible knives Sonder-Wendschneidplatten Plaquettes reversibles especiales Coltelli reversibili speciali Cuchillas reversibles especiales	
<b>T06MF</b>	Grooving knives Nuter Couteaux pour rainures Coltelli per incastri Cuchillas para ranura	
<b>T08MF</b>	Spurs, portable planers Vorschneider, Handhobel Araseurs, rabots electro portatifs Rasanti, piallatrici portatili Incisores, acepilladoras electricas	
<b>T10MG</b>	45° knives, planer knives 45°-Wendschneidplatten, Hobelkopfplatten Plaquettes 45°, couteaux pour outils à raboter Coltelli 45°, coltelli per teste da pialla Cuchillas 45°, cuchillas para cepillar	

					
+++	Excellent	Hervorragend	Parfaitement	Ottimo	Perfectamente
++	Very Good	Sehr gut	Très bien	Molto idoneo	Muy
+	Good	Gut	Bien	Idoneo	Algo
0	Acceptable	Akzeptabel	Acceptable	Accettabile	Acceptable
-	Not too good	Weniger gut	Moins bien	Meno idoneo	Mal
--	Poor	Schlecht geeignet	Mal adapté	Poco idoneo	Nada apropiado
---	Not suitable	Nicht geeignet	Pas utilisable	Non utilizzabile	No utilizable



-  Reversible knives and edge rounding knives
-  Wendeschneidplatten und Kantenrunder
-  Plaquettes reversibles et couteaux brise-arrête
-  Coltelli reversibili e spigolatori
-  Cuchillas reversibles y cuchillas para aristas



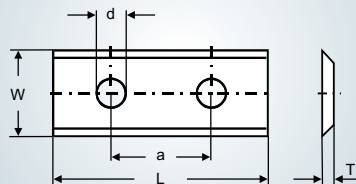

	<ul style="list-style-type: none"> <li> Standard reversible knives 35°</li> <li> Standard Wendeschneidplatten 35°</li> <li> Plaquettes reversibles standard 35°</li> <li> Coltelli reversibili standard 35°</li> <li> Cuchillas reversibles standard 35°</li> </ul>	13-14
	<ul style="list-style-type: none"> <li> Reversible knives</li> <li> Wendeschneidplatten</li> <li> Plaquettes reversibles</li> <li> Coltelli reversibili</li> <li> Cuchillas reversibles</li> </ul>	15
	<ul style="list-style-type: none"> <li> Square knives</li> <li> Quadratische Wendeschneidplatten</li> <li> Plaquettes reversibles à quatre coupes</li> <li> Coltelli reversibili quadrati</li> <li> Cuchillas reversibles cuadradas</li> </ul>	16-18
	<ul style="list-style-type: none"> <li> Spurs, grooving knives</li> <li> Vorschneider, Nuter</li> <li> Araseur, couteaux pour rainures</li> <li> Rasanti, coltelli per incastri</li> <li> Incisores, cuchillas para ranura</li> </ul>	19
	<ul style="list-style-type: none"> <li> Standard reversible knives - 4 cutting edges</li> <li> Standard Wendeschneidplatten - 4 Schneidkanten</li> <li> Plaquettes reversibles standard - 4 tranchants</li> <li> Coltelli reversibili standard - 4 taglienti</li> <li> Cuchillas reversibles standard - 4 filos de corté</li> </ul>	20
	<ul style="list-style-type: none"> <li> Reversible knives 45°</li> <li> Wendeschneidplatten 45°</li> <li> Plaquettes reversibles 45°</li> <li> Coltelli reversibili 45°</li> <li> Cuchillas reversibles 45°</li> </ul>	21
	<ul style="list-style-type: none"> <li> Mini reversible knives</li> <li> Mini-Wendeschneidplatten</li> <li> Mini plaquettes reversibles</li> <li> Mini coltelli reversibili</li> <li> Mini cuchillas reversibles</li> </ul>	22
	<ul style="list-style-type: none"> <li> Reversible knives for Systems Leitz, Oertli, KWO/Versofix, with chip breakers</li> <li> Wendeschneidpl. für Systeme Leitz, Oertli, KWO/Versofix, mit Spanbrechernuten</li> <li> Plaquettes rev. pour Systèmes Leitz, Oertli, KWO/Versofix, avec brise copeux</li> <li> Coltelli reversibili per sistemi Leitz, Oertli, KWO/Versofix, con rompitrucolo</li> <li> Cuchillas rev. para sistemas Leitz, Oertli, KWO/Versofix, con rompevirutas</li> </ul>	23-24
	<ul style="list-style-type: none"> <li> Reversible knives for portable planers</li> <li> Wendeplatten für Handhobel</li> <li> Plaquettes pour rabots électro portatifs</li> <li> Coltelli per piallatrici portatili</li> <li> Cuchillas para acepilladoras electricas</li> </ul>	25
	<ul style="list-style-type: none"> <li> Edge rounding knives</li> <li> Kantenrunder</li> <li> Couteaux brise-arrête</li> <li> Spigolatori</li> <li> Cuchillas para aristas</li> </ul>	26

-  Standard reversible knives
-  Standard-Wendeschneidplatten
-  Plaquettes reversibles standard
-  Coltelli reversibili standard
-  Cuchillas reversibles standard

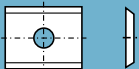
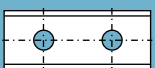
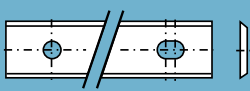
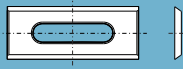

35 °

	L mm	W mm	T mm	a mm	T04F	T02UMG	T02SMG	T03SMG	T10MG	T08CR
	7.5	12.0	1.5		012001			013811	013963	106822
	8.6	12.0	1.5		013182					
	9.0	12.0	1.5		012043					
	9.6	12.0	1.5		012015			013850	014010	106823
	10.0	12.0	1.5		013165					
	10.5	12.0	1.5		013167					
	11.0	12.0	1.5		013168					
	11.6	12.0	1.5		013183					
	13.0	12.0	1.5		013170					
	13.6	12.0	1.5		013185					
	14.6	12.0	1.5		013186					
	15.0	12.0	1.5		012003			013819	013972	106824
	15.7	12.0	1.5		013172					
	16.0	12.0	1.5		013203					
	17.0	12.0	1.5		013173					
18.0	12.0	1.5		013174						
19.0	12.0	1.5		013175						
20.0	12.0	1.5		012004	115081	041587	013823	013977	104796	
25.0	12.0	1.5		012025			013853	014013	106826	
	25.0	12.0	1.5	14.0	012011			013843	014001	106827
	30.0	12.0	1.5	14.0	012005	115082	037750	013828	013982	104795
	35.0	12.0	1.5	26.0	013208					
	40.0	12.0	1.5	26.0	012014	115083	052278	013847	014006	106828
	50.0	12.0	1.5	26.0	012006	115085	037901	013834	013987	106829
	60.0	12.0	1.5	26.0	012007	115086	054882	013839	013994	106830
	L mm	W mm	T mm	a mm	T08MF			T03SMG	T10MG	T08CR
	80.0	13.0	2.2	60.0	012008			013841	013997	106831
	100.0	13.0	2.2	60.0	012009			030831	013998	106832
	120.0	13.0	2.2	60.0	012010			030832	013999	106833
<b>New !</b> 	L mm	W mm	T mm		T04F					
	30.0	12.0	1.5		121900					
	50.0 60.0	12.0	1.5		121901 121902					

-  Standard reversible knives
-  Standard-Wendeschneidplatten
-  Plaquettes reversibles standard
-  Coltelli reversibili standard
-  Cuchillas reversibles standard

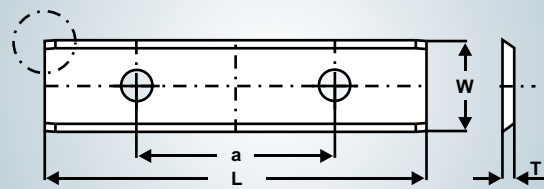

For use in planer heads!  
Für Hobelköpfe!

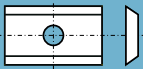
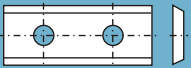

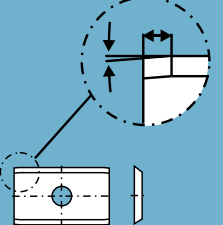
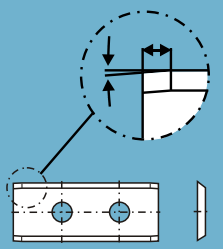
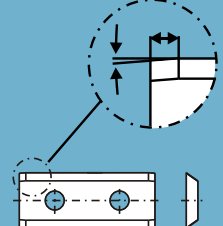



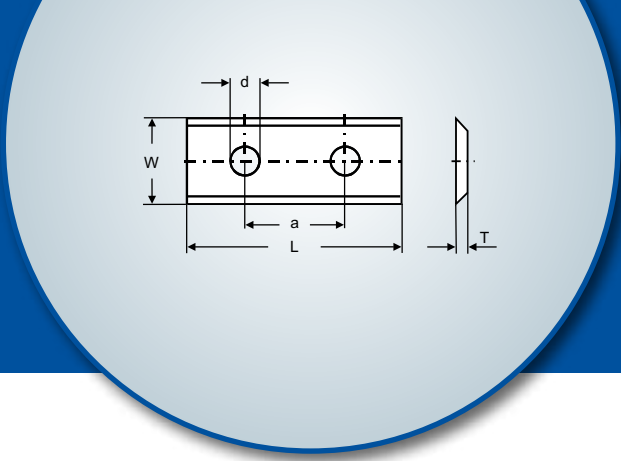

	L mm	W mm	T mm		T04F	T03SMG
	20.0	12.0	2.5		100686	101037
	30.0	12.0	2.5		054259	101038
	50.0	12.0	2.5		100687	101039

	L mm	W mm	T mm		T04F	T10MG	T08CR
	20.0	12.0	1.5	35°		013979	106674
	24.0	12.0	1.5	40°	104119	041060	106675
	24.7	12.0	1.5	35°	104120		106676
	30.0	12.0	1.5	35°		013984	106677
	40.0	12.0	1.5	35°		014008	106678
	50.0	12.0	1.5	35°		013989	106679
	60.0	12.0	1.5	35°			106680
	30.0	12.0	2.5	35°	102283		

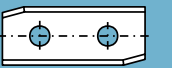

-  Reversible knives
-  Wendeschneidplatten
-  Plaquettes reversibles
-  Coltelli reversibili
-  Cuchillas reversibles

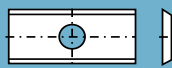
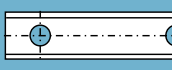

	L mm	W mm	T mm	a mm	T04F	T03SMG	T10MG
	20.0	14.3	2.5		013730	033492	033491
	44.5	15.0	1.5	25.0	013447		
	30.0	12.0	1.5	16.0	013449	033490	033477
	24.0	12.0	1.5		013241		
	30.0	12.0	1.5	14.0	013430	013924	033466
	50.0	12.0	1.5	26.0	013432	033470	033468
	30.0	12.0	1.5	14.0	013431	013925	033467
	50.0	12.0	1.5	26.0	013433	033471	033469
	20.0	12.0	1.5		013436	033480	033479
	20.0	12.0	1.5		013441	033481	033482
	30.0	12.0	1.5	14.0	013437	013926	033489
	40.0	12.0	1.5	26.0	013440		
	50.0	12.0	1.5	26.0	013438	013927	014038
	30.0	12.0	1.5	14.0	013442	013928	033484
	40.0	12.0	1.5	26.0	013445		
	50.0	12.0	1.5	26.0	013443	013929	014039

	L mm	W mm	T mm	a mm	T04F
	20.0	9.0	1.5		013195
	24.0	9.0	1.5	14.0	013197
	30.0	9.0	1.5	14.0	013199
	40.0	9.0	1.5	26.0	013200
	50.0	9.0	1.5	26.0	013201

 Square knives

 Quadratische Wendeschneidplatten

 Plaquettes reversibles à quatre coupes

 Coltelli reversibili quadrati

 Cuchillas reversibles cuadradas

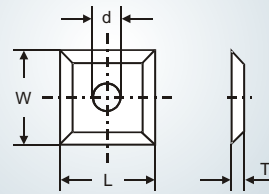

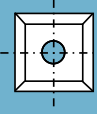
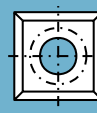
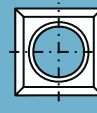
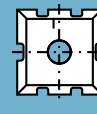
	L mm	W mm	T mm		d mm	T08MF	T04F	T02SMG	T03SMG	T10MG	T08CR
	9.0	9.0	1.5	35°	4.0		100744				
	10.5	10.5	1.5	35°	4.0		013259		013863	014027	106834
	12.0	12.0	1.5	35°	4.0		012002	048357	013815	013968	106835
	13.0	13.0	2.5	35°	4.0	013328					
	17.0	17.0	2.0	35°	3.0	016565	016564				
	17.0	17.0	2.0	35°	4.0	013266	013265		013864	030830	106836
	19.0	19.0	2.0	35°	4.0		013264		030838	030827	106837
	10.5	10.5	1.5	35°							106682
	13.0	13.0	2.5	30°		013324					
	13.6	13.6	2.0	30°		013299					
	13.6	13.6	2.0	45°		037522					
	14.0	14.0	1.2	30°		013295					
	14.0	14.0	1.7	22°		013297					
	14.0	14.0	1.7	30°		013307					
14.0	14.0	2.0	30°		013273	013260	054962	013865	014028	102558	
 For Holz-Her system*	14.0	14.0	1.2	30°		013303					
	15.0	15.0	2.0			013322				014029	

\* For use in Holz-Her cutterheads only

\* Nur zur Verwendung in Messerköpfen der Firma Holz-Her

\* Utilisation limitée aux porte outils de l'entreprise Holz-Her

\* Da usare solo su teste portacoltelli della Holz-Her

\* Sólo para empleo con portacuchillas de la firma Holz-Her



 Square knives

 Quadratische Wendschneidplatten

 Plaquettes reversibles à quatre coupes

 Coltelli reversibili quadrati

 Cuchillas reversibles cuadradas

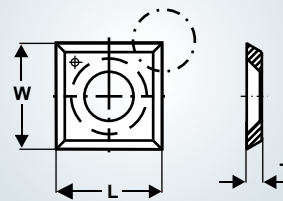

For use in planer heads!  
Für Hobelköpfe!

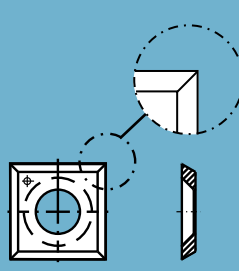
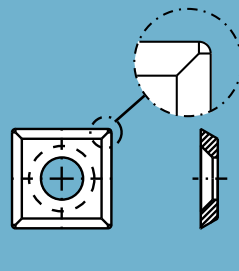
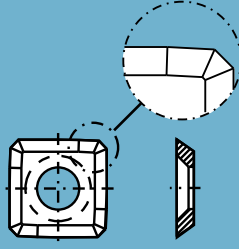
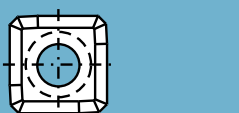
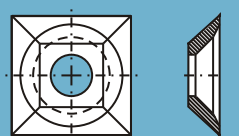
	L	W	T		T08MF	T04F	T10MG	T08CR	TL15
	mm	mm	mm						
<b>Straight with sharp edges</b> 	10.5	10.5	1.5	35°				106682	040343
	14.0	14.0	2.0	30°	013273	013260	014028	102558	013771
	14.0	14.0	2.0	37°	104295		104900		
	14.3	14.3	2.5	35°			013329	106683	
	14.6	14.6	2.5	30°			013314	106684	
	15.0	15.0	2.5	30°			013315	106685	
	15.0	15.0	2.5	37°			104062		
<b>Straight with rounded edges</b> 	14.0	14.0	2.0	30°	013276		104117		
	14.3	14.3	2.5	30°			104208		
	14.6	14.6	2.5	30°			013316		
	15.0	15.0	2.5	30°			104118		
	15.0	15.0	2.5	37°			109384		
<b>left</b>  <b>For System Ledinek *</b>	14.3	14.3	2.5	35°			053589		
	14.3	14.3	2.5	35°			053590		
<b>right</b> 									
	21.0	21.0	5.5	40°			022695		

\* For use in Ledinek-cutterheads only

\* Nur zur Verwendung in Messerköpfen der Firma Ledinek

\* Utilisation limitée aux porte outils de l'entreprise Ledinek

\* Da usare solo su teste portacoltelli della Ledinek

\* Sólo para empleo con portacuchillas de la firma Ledinek



 Square knives

 Quadratische Wendeschneidplatten

 Plaquettes reversibles à quatre coupes



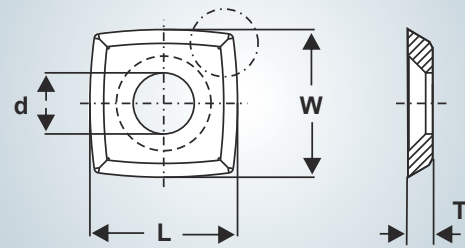

 Coltelli reversibili quadrati

 Cuchillas reversibles cuadradas

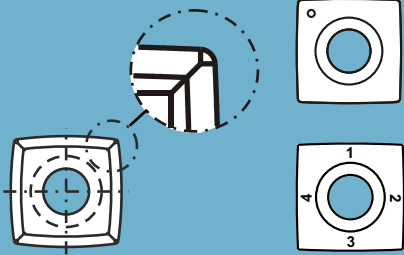
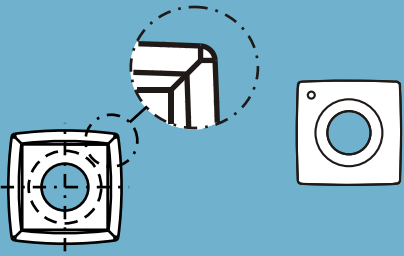
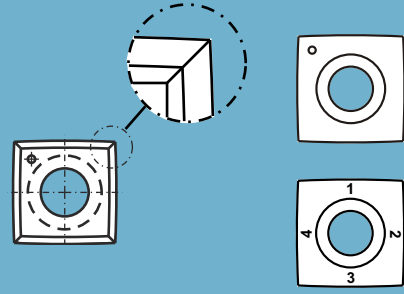
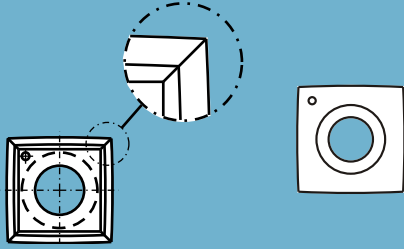

For use in planer heads!  
Für Hobelköpfe!



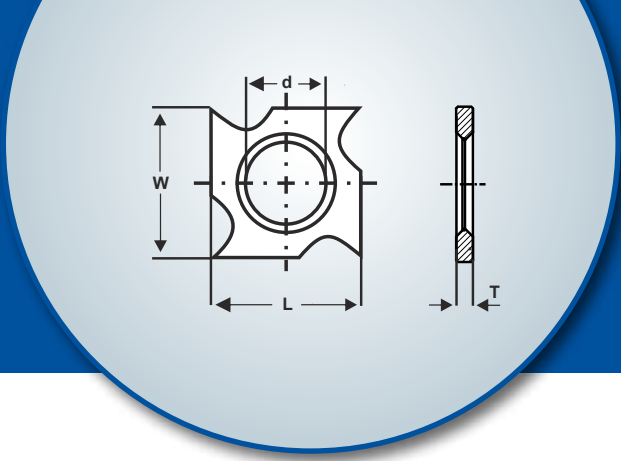

	L mm	W mm	T mm	R	T10MG
<b>Cutting edge with radius and rounded edges</b> 	15.0	15.0	2.5	R=150	013320
	15.0	15.0	2.5	R=150	101540
	15.0	15.0	2.5	R=115	115179
	14.0	14.0	2.0	R=150	100788
	14.6	14.6	2.5	R=150	052673
	15.0	15.0	2.5	R=50	043895
<b>Cutting edge with radius and pointed edges</b> 	15.0	15.0	2.5	R=150	100791
	15.0	15.0	2.5	R=100	113993
	15.0	15.0	2.5	R=150	104115
	14.0	14.0	2.0	R=150	100789
	14.6	14.6	2.5	R=150	100790
	15.0	15.0	2.5	R=50	101044

-  Spurs, grooving knives
-  Vorschneider, Nuter
-  Araseur, couteaux pour rainures
-  Rasanti, coltelli per scanalature
-  Incisores, cuchillas para ranura

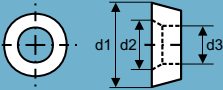



	L mm	W mm	T mm		d mm	T08MF	T04F	T06MF	T10MG
	18.0	18.0	1.95			013293			
	18.0	18.0	2.45			013291			
	18.0	18.0	2.95			013305			
	18.0	18.0	3.70			013289			
	22.9	19.8	2.5	30°		045180			
	22.0	19.0	2.0	30°		013271			
	(22.0)	(22.0)	(2.0)						
	14.0	28.0	2.0	30°		013258			
	16.0	16.0	3.0	32°		030829			
	18.5		3.25	30°					017190
	33.5				3.0	013252			
	18.9	7.9	4.0			013253			
	18.0	5.7	3.5				013255		
	24.5	13.0	4.0					053640	
	24.5	13.0	5.0					053641	
	34.0	16.0	4.0					013278	
	34.0	16.0	5.0					013279	
	34.0	16.0	6.0					013280	
	34.0	16.0	7.0					013281	

	d1 mm	d2 mm	d3 mm	T mm		T03SMG
	11.0	7.0	5.1	4.0		013373

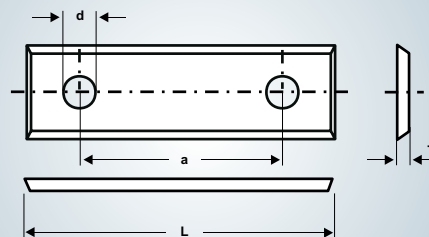
-  Standard reversible knives
-  Standard Wendeschneidplatten
-  Plaquettes reversibles standard
-  Coltelli reversibili standard
-  Cuchillas reversibles standard



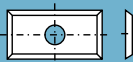
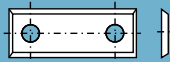

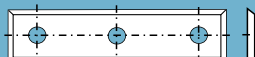
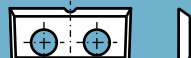
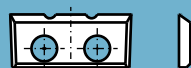
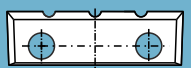
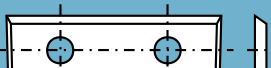
4 cutting edges  
4 Schneidkanten  
4 tranchants  
4 taglienti  
4 filos de corte

	L mm	W mm	T mm	a mm	T04F	T03SMG	T10MG	TL15
	19.5	7.0	1.5		013492	030874	030886	030904
	19.5	7.5	1.5		013493	030875	030887	030905
	19.5	8.0	1.5		013494	013945	030888	030906
	19.5	9.0	1.5		013495	013946	030889	030907
	19.5	10.0	1.5		013496	030876	030890	030908
	19.5	11.0	1.5		013497	030877	030891	030909
	19.5	12.0	1.5		013498	013947	030892	013774
	29.5	7.0	1.5	14.0	013501	030878	030893	030910
	29.5	7.5	1.5	14.0	013502	013948	030894	030911
	29.5	8.0	1.5	14.0	013503	013949	030895	030912
	29.5	9.0	1.5	14.0	013504	013950	030896	030913
	29.5	10.0	1.5	14.0	013505	030879	030897	030914
	29.5	11.0	1.5	14.0	013506	030880	030898	030915
	29.5	12.0	1.5	14.0	013507	013952	014088	013775
	39.5	9.0	1.5	26.0	013511	045134		
	39.5	12.0	1.5	26.0	013512	013954	014089	030916
	49.5	8.0	1.5	26.0	013516	013955	030899	030917
	49.5	9.0	1.5	26.0	013517	013956	030900	030918
	49.5	10.0	1.5	26.0	013518	030881	030901	030919
	49.5	11.0	1.5	26.0	013519	030882	030902	030920
	49.5	12.0	1.5	26.0	013520	013957	014090	013776
	59.5	12.0	1.5	26.0	013523	013958	030903	030921
	50.0	9.0	1.5	37.0	016950	035425		
	50.0	10.0	1.7	37.0	016966	030883	030884	
	50.0	12.0	1.7	37.0	013327	013866	014030	
	16.0	7.0	1.5	7.0	048995	052579		
	16.0	7.0	1.5	7.0	048996	052580		
	23.0	7.0	1.5	14.0	106866			
	23.0	7.0	1.5	14.0	106867			
	16.0	7.0	1.5	7.0	016934	016933		
	23.0	7.0	1.5	14.0	053449			
	28.0	7.0	1.5	14.0	016823	016822		
	31.5	9.0	1.5	14.0	109149			



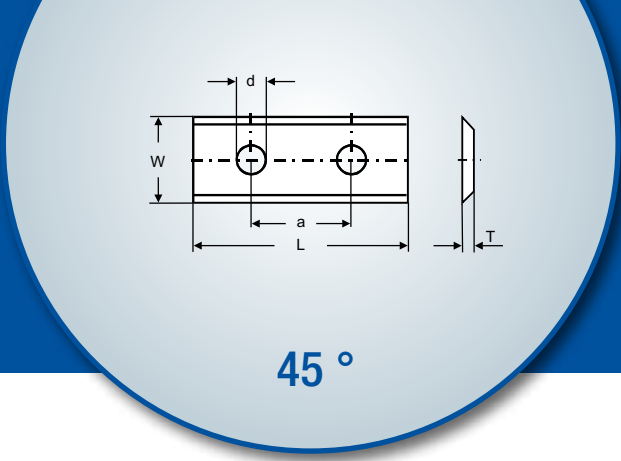

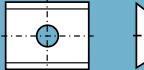
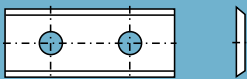

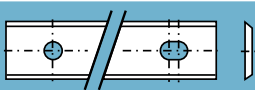

-  Reversible knives
-  Wendeschneidplatten
-  Plaquettes reversibles
-  Coltelli reversibili
-  Cuchillas reversibles

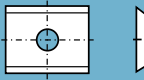
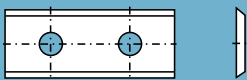

	L mm	W mm	T mm	a mm	T08MF	T10MG	TL15
 	7.5	12.0	1.5			014091	013777
	9.6	12.0	1.5			014115	030851
	15.0	12.0	1.5			014098	013780
	20.0	12.0	1.5			014100	013781
	25.0	12.0	1.5			014123	013788
	25.0	12.0	1.5	14.0		014110	013786
	30.0	12.0	1.5	14.0		014102	013783
	40.0	12.0	1.5	26.0		014113	013787
	50.0	12.0	1.5	26.0		014105	013784
	60.0	12.0	1.5	26.0		014107	013785
	12.0	12.0	1.5			014096	013778
	80.0	13.0	2.2	60.0	013532	038233	



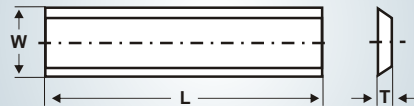

**>>MICROFINISH<<**

	L mm	W mm	T mm	a mm	T10MG	TL15
	7.5	12.0	1.5		014093	030861
	9.6	12.0	1.5		014117	030864
	15.0	12.0	1.5		014099	030862
	20.0	12.0	1.5		014101	013782
	25.0	12.0	1.5		014124	030865
	25.0	12.0	1.5	14.0	014111	030863
	30.0	12.0	1.5	14.0	014103	030866
	40.0	12.0	1.5	26.0	014114	030870
	50.0	12.0	1.5	26.0	014106	030868
	60.0	12.0	1.5	26.0	014108	030869
		12.0	12.0	1.5		014097

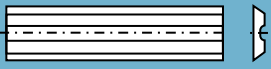
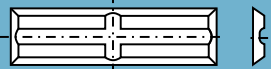
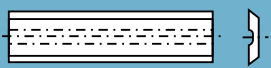
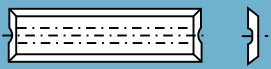
-  Mini reversible knives
-  Mini-Wendeschneidplatten
-  Mini plaquettes reversibles
-  Mini coltelli reversibili
-  Mini cuchillas reversibles



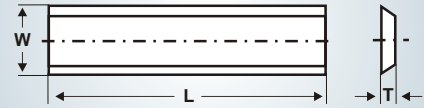

	L mm	W mm	T mm	T04F	T03SMG	Style
	12.0	5.5	1.1	013355	013882	Back groove
	20.0	5.5	1.1	013357	013884	Rückennut
	30.0	5.5	1.1	013363	013890	Rainure sur petite face
	40.0	5.5	1.1	013359	013886	Scanalatura posteriore
	50.0	5.5	1.1	013361	013888	Ranura de lomo
	20.0	4.1	1.1	013403		Back and crossgroove
	20.0	5.5	1.1	013394	013911	Rücken- und Quernut
	25.0	5.5	1.1	013402	013920	Rainure transversal
	30.0	5.5	1.1	013397	013914	Scanalatura di sicurezza
	40.0	5.5	1.1	013399	013916	Ranura transversal
	50.0	5.5	1.1	013401	013918	
	12.0	5.5	1.1	013334	013870	Face groove
	20.0	5.5	1.1	013336	013872	Brustnut
	30.0	5.5	1.1	013345	013880	Rainure sur grande face
	40.0	5.5	1.1	013339	013874	Scanalatura frontale
	50.0	5.5	1.1	013342	013877	Ranura frontal
	20.0	5.5	1.1	013378	030871	4 Cutting edges
	25.0	5.5	1.1	013376	030872	4 Schneidkanten
	30.0	5.5	1.1	013379	030847	4 Tranchants
	35.0	5.5	1.1	013377	013893	4 Taglienti
						4 Filos de corte
	40.0	5.5	1.1	013380	013898	
	44.5	5.5	1.1	013375	030873	
	50.0	5.5	1.1	013381	013900	

-  Reversible knives for systems
-  Wendeschneidplatten für Systeme
-  Plaquettes reversibles pour les systèmes
-  Coltelli reversibili per sistemi
-  Cuchillas reversibles para sistemas

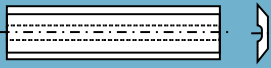

For Systems Leitz and Oertli

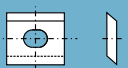
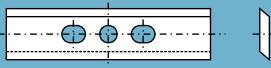
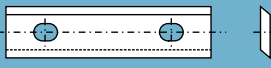
For Leitz system*	L mm	W mm	T mm	T04F	T03SMG	T10MG
	7.7	8.0	1.5	013457	013930	014041
	9.7	8.0	1.5	013470	013942	014065
	11.7	8.0	1.5	013458	013931	014043
	14.7	8.0	1.5	013459	013932	014045
	19.7	8.0	1.5	013460	013933	014047
	24.7	8.0	1.5	013472	013943	014068
	30.0	8.0	1.5	013461	013934	014049
	35.0	8.0	1.5	013462	013935	014051
	40.0	8.0	1.5	013463	013936	014053
	45.0	8.0	1.5	013488	049488	014081
	50.0	8.0	1.5	013464	013937	014055
	60.0	8.0	1.5	013466	013938	014057
	70.0	8.0	1.5	013478	030927	014074
	80.0	8.0	1.5	013467	013939	014059
	100.0	8.0	1.5	013468	013940	014061
	120.0	8.0	1.5	013469	049489	014063

For Oertli system*	L mm	W mm	T mm	T04F	T10MG
	8.8	8.0	1.5	030931	017193
	9.0	8.0	1.5	030932	017194
	9.5	8.0	1.5	030933	017195
	11.0	8.0	1.5	030934	017196
	12.0	8.0	1.5	030935	017197
	15.0	8.0	1.5	030936	017198
	20.0	8.0	1.5	030937	017200
	25.0	8.0	1.5	030938	017201
28.0	8.0	1.5	030939	017202	
	32.0	8.0	1.5	030940	017203
	40.0	8.0	1.5	030941	017204
	50.0	8.0	1.5	030942	017206
	60.0	8.0	1.5	030943	017207
	80.0	8.0	1.5	030944	017209
	100.0	8.0	1.5	030945	017210
	12.0	12.0	1.5	034294	034295





\* For use in Leitz/Oertli-cutterheads only

\* Nur zur Verwendung in Messerköpfen der Firma Leitz bzw. Oertli

\* Utilisation limitée aux porte outils des entreprises Leitz et Oertli

\* Da usare solo su teste portacottelli della Leitz - Oertli

\* Sólo para empleo con portacuchillas de la firma Leitz/Oertli

-  Reversible knives for system
-  Wendeschneidplatten für System
-  Plaquettes reversibles pour le système
-  Coltelli reversibili per sistema
-  Cuchillas reversibles para sistema

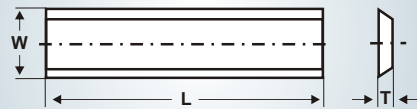

For System KWO/Versofix

For KWO/Versofix system*	L mm	W mm	T mm	T03SMG TiN-coated	T10MG TiN-coated
	20.0	5.5	1.1	049525	049526
	30.0	6.5	1.1	101074	101075
	50.0	6.5	1.1	101078	101079
	20.0	10.0	1.5	014273	030841
	30.0	10.0	1.5	014275	030842
	50.0	10.0	1.5	014277	030843
 with chamfer	50.0	10.0	1.5	014279	030844

-  Reversible knives with chip breakers
-  Wendeschneidplatten mit Spanbrechernuten
-  Plaquettes reversibles avec brise copeaux
-  Coltellini con rompitrucolo
-  Cuchillas reversibles con rompevirutas

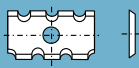
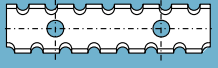
	L mm	W mm	T mm	a mm	T04F
	20.0	12.0	1.5		030928
	30.0	12.0	1.5	14.0	013117
	50.0	12.0	1.5	26.0	013127
	60.0	12.0	1.5	26.0	108318

\* For use in KWO/Versofix-cutterheads only





\* Nur zur Verwendung in Messerköpfen der Firma KWO/Versofix

\* Utilisation limitée aux porte outils de l'entreprise KWO/Versofix



\* Da usare solo su teste portacoltelli della KWO/Versofix

\* Sólo para empleo con portacuchillas de la firma KWO/Versofix



-  Reversible knives for portable planers
-  Wendeschneidplatten für Handhobel
-  Plaquettes pour rabots électro portatifs
-  Coltelli per piallatrici portatili
-  Cuchillas para acepilladoras electricas

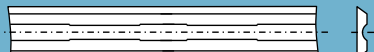

	L mm	W mm	T mm	T08MF	
	56.0	5.5	1.1	013041	Adler
	60.0	5.5	1.1	013053	Wegoma
	75.5	5.5	1.1	013001	AEG, Bosch, Festo, Haffner, Kress, Mafell, Metabo, Scheer, Skil, Holz-Her
	78.0	5.5	1.1	013067	Virutex
	82.0	5.5	1.1	013082	Casals
	92.0 102.0	5.5 5.5	1.1 1.1	013058 013061	AEG, Hitachi, Ryobi AEG
	75.7	5.5	1.2	013018	B&D
	80.5	5.9	1.2	013043	ELU
	80.5	5.5	1.1	013010	ELU
	82.0	5.5	1.1	013020	AEG, B&D, Bosch, ALU, Fein, Felisatti, Haffner, Hitachi, Holz-Her, Mafell, Makita, Metabo, Peugeot, Ryobi, Skil
	82.0	5.1	1.2	013034	Face groove, Brustnut, Rainure sur grande face, Scanalatura frontale, Ranura frontal

 Edge rounding knives

 Kantenrunder

 Couteaux brise-arrête

 Spigolatori

 Cuchillas para aristas

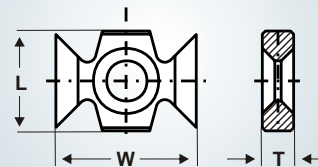

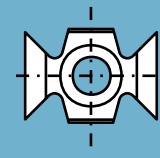
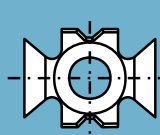
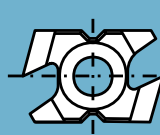
	L mm	W mm	T mm	Type	T10MG
	16.0	22.0	5.0	TKM 45°	032292
	16.0	22.0	5.0	TKM R 1.5	032294
	16.0	22.0	5.0	TKM R 2.0	032295
	16.0	22.0	5.0	TKM R 2.5	032296
	16.0	22.0	5.0	TKM R 3.0	032297
	16.0	22.0	5.0	TKM R 4.0	032299
	16.0	22.0	6.0	TKM R 5.0	032301
 For Leitz-system „Mechanical“ *	15.0	20.0	8.0	TKM 11/0 - 45°	032304
	15.0	22.3	9.0	TKM 12/0 R3	032306
	15.0	20.0	9.0	TKM 12/1 R3	032307
	15.0	20.0	7.3	TKM 12/3 R2	032308
	15.0	18.3	7.3	TKM 12/3 R2F	032309
	15.0	20.0	7.0	TKM 12/4 R1.5	032310
	15.0	22.3	10.0	TKM 12/5 R3F	032311
	15.0	22.3	7.3	TKM 13/0 (R1) N=5	032312
	15.0	22.3	9.0	TKM 13/1 (R1) N=7	032313
15.0	22.3	7.3	TKM 16/0	032315	
 For Leitz-system “BG-Test“ *	15.0	23.0	8.0	TKM 21/0 - 45°	032316
	15.0	23.0	9.0	TKM 22/0 R3	032318
	15.0	23.0	7.3	TKM 22/3 R2	032320
	15.0	23.0	7.0	TKM 22/4 R1.5	032322
	15.0	23.0	9.0	TKM 22/5 R3F	032323
	15.0	23.0	9.0	TKM 22/1 R3	032319
	15.0	25.7	7.3	TKM 24/0 R5	032327
	15.0	25.7	7.3	TKM 24/1 R5	032326

\* For use in Leitz-cutterheads only

\* Nur zur Verwendung in Messerköpfen der Firma Leitz

\* Utilisation limitée aux porte outils de l'entreprise Leitz

\* Da usare solo su teste portacoltelli della Leitz





\* Sólo para empleo con portacuchillas de la firma Leitz







**Tools cut better  
with TIGRA**



2

-  **Blanks for profiling and radius knives**
-  **Blanketts zum Profilieren und Radienplatten**
-  **Plaquettes à profiler et plaquettes profilées**
-  **Placchette da profilare e placchette profilate**
-  **Placas para perfilar y perfiladas**



-  **Blanks for profiling - TIGRA carbide grades and their applications – Technical Data**
-  **Blanketts zum Profilieren - TIGRA Hartmetallsorten und ihre Anwendungen – Technische Daten**
-  **Plaquettes à profiler - Les nuances de carbures TIGRA et leurs applications – Caractéristiques techniques**
-  **Placchette da profilare - I tipi di metallo duro TIGRA e le loro applicazioni – Dati tecnici**
-  **Placas para perfilar - Calidades de metal duro TIGRA y sus aplicaciones – Datos técnicos**

	TIGRA grade TIGRA - Sorte Nuance TIGRA Tipo TIGRA Calidad TIGRA	Binder	Hardness		Bending strength		Toughness
		Binder Liant Legante Composicion	Härte Dureté Durezza Dureza		Biegebruchfestigkeit Resistance à la flexion Resistenza flessionale Resistencia a la flexión		Zähigkeit Ténacité Tenacità Tenacidad
		%	HV 10	HRA ±0.2	N/mm <sup>2</sup>	psi	K <sub>1C</sub> / MPa.m <sup>-1/2</sup>
<b>T03SMG</b>	ISO: K01 USA: C4 ++	3.5	2100	94.6	2400	348.000	6.4
<b>T04F</b>	ISO: K05 USA: C4	4.0	1750	92.8	2350	341.000	8.6
<b>T08CR*</b>	ISO: K01 USA: C4 +	4.3	1900	93.6	2350	341.000	8.5
<b>T10MG</b>	ISO: K10-K40 USA: C3 +	10.0	1650	92.3	3600	522.000	9.4
<b>TL15*</b>		13.5	1450	90.7	3800	551.000	10.5



\* Special binder - Spezialbinder - Liant special - Legante speciale - Composicion especial











	TIGRA grade TIGRA - Sorte Nuance TIGRA Tipo TIGRA Calidad TIGRA	HDF	MDF	Chipboard Spanplatte Panneaux de particule Truciolare Panel de aglomerado	Hardwood Hartholz Bois dur Legno duro Madera dura	Softwood Weichholz Bois tendre Legno tenero Madera blanda
		<b>T03SMG</b>	++	++	++	0
<b>T04F</b>	0	+	++	+	+	
<b>T08CR</b>	0	++	++	++	+	
<b>T10MG</b>	-	0	0	++	++	
<b>TL15</b>	---	--	--	++	+++	





					
+++	Excellent	Hervorragend	Parfaitement	Ottimo	Perfectamente
++	Very Good	Sehr gut	Très bien	Molto idoneo	Muy
+	Good	Gut	Bien	Idoneo	Algo
0	Acceptable	Akzeptabel	Acceptable	Accettabile	Acceptable
-	Not too good	Weniger gut	Moins bien	Meno idoneo	Mal
--	Poor	Schlecht geeignet	Mal adapté	Poco idoneo	Nada apropiado
---	Not suitable	Nicht geeignet	Pas utilisable	Non utilizzabile	No utilizable

















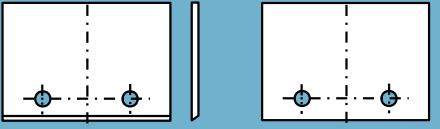





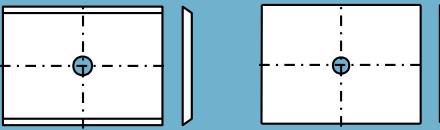





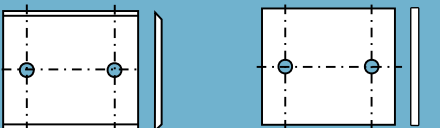





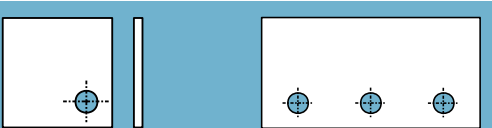











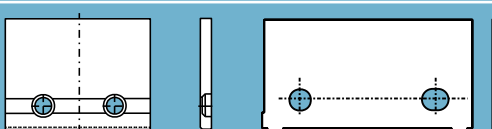

















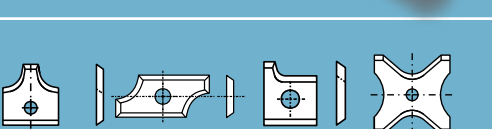









-  Blanks for profiling - TIGRA carbide grades and their applications
-  Blanketts zum Profilieren - TIGRA Hartmetallsorten und ihre Anwendungen
-  Plaquettes à profiler - Les nuances de carbures TIGRA et leurs applications
-  Placchette da profilare - I tipi di metallo duro TIGRA e le loro applicazioni
-  Placas para perfilar - Calidades de metal duro TIGRA y sus aplicaciones

 TIGRA grade  TIGRA - Sorte  Nuance TIGRA  Tipo TIGRA  Calidad TIGRA	Main usage Hauptanwendung Principal usage Main uso Uso principal	
<b>T03SMG</b>	Laminate flooring, edge banding knives Laminat, Messer für Kantenanleimer laminé, couteaux pour plaquettes de chants Laminato e coltelli per bordatrici Suelo laminado, cuchillas para chapeadoras de cantos	
<b>T04F</b>	Universal grade Universalsorte Nuance universelle Metallo duro universale Calidad universal	
<b>T08CR</b>	Abrasive materials, tropical woods Abrasive Hölzer, Tropenhölzer Bois abrasifs, bois tropicaux Legni abrasivi, legni tropicali Materiales abrasivos, maderas tropicales	
<b>T10MG</b>	Wood, window tooling Holz, Fensterwerkzeuge Bois, outillage pour fenêtres Legni, utensili di serramento Madera, herramientas para ventanas	
<b>TL15</b>	Soft wood, window tooling Weichholz, Fensterwerkzeuge Bois tendre, outillage pour fenêtres Legni teneri, utensili di serramento Madera blanda, herramientas para ventanas	

-  Blanks for profiling and radius knives
-  Blanketts zum Profilieren und Radienplatten
-  Plaquettes à profiler et plaquettes profilées
-  Placchette da profilare e placchette profilate
-  Placas para perfilar y perfiladas

	<ul style="list-style-type: none"> <li> Blanks with 1 bore hole at the bottom</li> <li> Blanketts mit 1 Bohrung unten</li> <li> Plaquettes avec 1 trou en bas</li> <li> Placchette con 1 foro basso</li> <li> Placas con 1 taladro abajo</li> </ul>	32-34
	<ul style="list-style-type: none"> <li> Blanks with 2 bore holes at the bottom</li> <li> Blanketts mit 2 Bohrungen unten</li> <li> Plaquettes avec 2 trous en bas</li> <li> Placchette con 2 fori bassi</li> <li> Placas con 2 taladros abajo</li> </ul>	35-39
	<ul style="list-style-type: none"> <li> Blanks with 1 bore hole in the center</li> <li> Blanketts mit 1 Bohrung mittig</li> <li> Plaquettes avec 1 trou au centre</li> <li> Placchette con 1 foro centrale</li> <li> Placas con 1 taladro en el centro</li> </ul>	40
	<ul style="list-style-type: none"> <li> Blanks with 2 bore holes in the center</li> <li> Blanketts mit 2 Bohrungen mittig</li> <li> Plaquettes avec 2 trous au centre</li> <li> Placchette con 2 fori centrali</li> <li> Placas con 2 taladros en el centro</li> </ul>	41-42
	<ul style="list-style-type: none"> <li> Special blanks for profiling</li> <li> Spezial-Blanketts zum Profilieren</li> <li> Plaquettes spéciales à profiler</li> <li> Placchette speciali da profilare</li> <li> Placas especiales para perfilar</li> </ul>	43
	<ul style="list-style-type: none"> <li> Superprofiler</li> <li> Superprofiler</li> <li> Superprofiler</li> <li> Superprofiler</li> <li> Superprofiler</li> </ul>	44-45
	<ul style="list-style-type: none"> <li> For systems Freud/Leuco/Oertli, crossgroove</li> <li> Für Systeme Freud/Leuco/Oertli, Quernut</li> <li> Pour systèmes Freud/Leuco/Oertli, rainure transversal</li> <li> Per sistemi Freud/Leuco/Oertli, scanalatura</li> <li> Para sistemas Freud/Leuco/Oertli, ranura transversal</li> </ul>	46-51
	<ul style="list-style-type: none"> <li> Blanks without bores</li> <li> Blanketts ohne Bohrung</li> <li> Plaquettes sans trous</li> <li> Placchette senza fori</li> <li> Placas sin taladro</li> </ul>	52-53
	<ul style="list-style-type: none"> <li> Backing plates &amp; packing</li> <li> Stützplatten &amp; Verpackungen</li> <li> Supports &amp; emballages</li> <li> Supporti &amp; imballi</li> <li> Placas de soporte &amp; embalaje</li> </ul>	54-55
	<ul style="list-style-type: none"> <li> Profiled &amp; preprofiled standard blanks</li> <li> Profilierte und vorprofilierte Standardblanketts</li> <li> Plaquettes standard profilées &amp; preprofilées</li> <li> Placchette profilate &amp; presagomate standard</li> <li> Placas perfiladas &amp; preperfiladas standard</li> </ul>	56-62
	<ul style="list-style-type: none"> <li> TIGRAlloy blanks for profiling</li> <li> TIGRAlloy-Blanketts zum Profilieren</li> <li> TIGRAlloy plaquettes à profiler</li> <li> TIGRAlloy placchette da profilare</li> <li> TIGRAlloy placas para perfilar</li> </ul>	63-66

-  Blanks for profiling
-  Blanketts zum Profilieren
-  Plaquettes à profiler
-  Placchette da profilare
-  Placas para perfilar

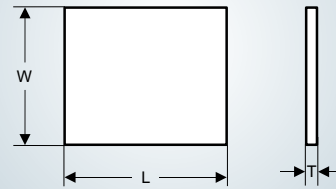

-  **Dimensions:** The following pages represent only a small standard part of our extensive delivery program. Additionally TIGRA supplies almost any special dimension or execution upon customer request.

**Carbide grades:** The blanks are available in all required carbide grades. By using the optimum carbide grade you are able to give to your customers the optimum in lifetime and surface quality.

**Preprofiled blanks:** With the use of preformed blanks the time-consuming roughing or wire cutting process is eliminated. You can immediately start finish grinding and therefore you save the majority of the normal profiling cost.
-  **Abmessungen:** Die folgenden Seiten stellen nur einen kleinen Ausschnitt unseres Lieferprogramms dar. Zusätzlich liefert TIGRA fast jede Art von Sonderausführung nach Kundenwunsch.

**Hartmetallsorten:** Blanketts sind in allen gewünschten Hartmetallsorten lieferbar. Durch Verwendung der optimalen Hartmetallsorte können Sie Ihren Kunden stets ein Optimum an Standzeit und Oberflächengüte bieten.

**Vorprofilierter Blanketts:** Mit der Verwendung vorprofilierter Blanketts entfällt der zeitraubende Schruppvorgang bzw. das Drahtschneiden. Sie können sofort mit dem Schlichten beginnen und sparen so den größten Teil der Profilierkosten ein.
-  **Dimensions:** Les pages suivantes seulement présentent un petit extrait de notre gamme. TIGRA est également en mesure de fournir quasiment n'importe quelle exécution spéciale sur demande du client.

**Types de carbures:** Les ébauches sont disponibles dans tous les types de carbures souhaités. En utilisant des types de carbures optimaux, vous serez toujours en mesure d'offrir à vos clients le meilleur niveau de durabilité et de qualité de surface.





**Plaquettes à profiler:** L'utilisation d'ébauches préprofilées permet de supprimer les longues opérations dégrossissage ou de coupe au fil. Vous pouvez immédiatement commencer la finition et économiser ainsi une grande partie des coûts de profilage.
-  **Misure:** Le pagine successive contengono solo una parte del nostro assortimento. In caso di necessità, TIGRA soddisfa ogni tipo di richiesta di produzione, anche di articoli con dimensioni particolari.

**Tipi di metallo duro:** Le placchette da profilare possono essere fornite in tutti i tipi di metallo duro desiderati. Anche in questo settore potete offrire ai Vostri clienti la soluzione ottimale in termini di tecnica applicativa.

**Placchette presagomate:** Con l'uso delle placchette presagomate non serve sgrossare. Potete cominciare subito con la finitura e ridurre una buona parte dei costi di profilatura.
-  **Dimensiones:** La páginas siguientes incluyen solamente una pequeña parte de nuestro programa de suministro. TIGRA fabrica prácticamente cualquier modelo especial a medida.

**Calidades de metal duro:** Disponemos de placas de todas la calidades de metal duro. Utilizando la calidad adecuada, podrá ofrecer a sus clientes rendimientos óptimos en duración y calidad superficial.



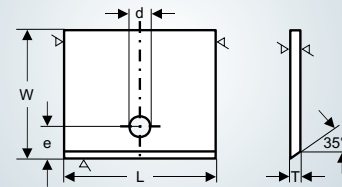

**Placas preperfiladas:** Las placas preperfiladas eliminan la costosa fase de desbastado resp. electroerosión a hilo. Podrá pasar directamente a la fase de acabado, eliminando así la mayor parte del coste correspondiente a la operación de perfilado.

-  Blanks for profiling
-  Blanketts zum Profilieren
-  Plaquettes à profiler
-  Placchette da profilare
-  Placas para perfilar







L mm	W mm	T mm	d mm	e mm	T04F	T03SMG	T08CR	T10MG	TL15
15.0	15.4	2.0	4.1	6.3	014535	030949	106450	030950	014541
15.0	20.4	2.0	4.1	6.3	014553	014556	106467	014559	014561
15.0	25.4	2.0	4.1	6.3	014573	030951	106453	014577	014579
15.0	30.4	2.0	4.1	6.3	014590	030952	106454	014595	030953
15.8	30.4	2.0	4.1	6.3	014598	014599	106455	014601	014602
16.0	20.4	2.0	4.1	6.3	014609	030954	106470	030955	030956
19.8	30.4	2.0	4.1	6.3	014614	030957	106456	014616	030958
20.0	20.4	2.0	4.1	6.3	014648	014651	104857	014655	014657
20.0	25.4	2.0	4.1	6.3	014684	014688	104858	014692	014696
20.0	30.4	2.0	4.1	6.3	014723	014727	104629	014729	014733
20.0	35.4	2.0	4.1	6.3	014750	014753	104711	014756	014758
20.0	40.4	2.0	4.1	6.3	014768	030959	106457	030960	030961
25.0	20.4	2.0	4.1	6.3	014783	014786	106458	014789	014792
25.0	25.4	2.0	4.1	6.3	014812	014816	104663	014819	014824
25.0	30.4	2.0	4.1	6.3	014848	014851	105103	014856	014861
25.0	35.4	2.0	4.1	6.3	014880	014883	106095	014887	014889
30.0	20.4	2.0	4.1	6.3	014917	030962	106460	014922	014925
30.0	25.4	2.0	4.1	6.3	014970	014974	104664	014980	014986
30.0	30.4	2.0	4.1	6.3	015045	015049	105255	015054	015059
30.0	35.4	2.0	4.1	6.3	015104	015108	106461	015113	015116
30.0	40.4	2.0	4.1	6.3	015148	030963	106463	015154	015157
35.0	20.4	2.0	4.1	6.3	015261	030964	106465	015265	015267
35.0	25.4	2.0	4.1	6.3	015286	030965	104922	015290	015293
35.0	30.4	2.0	4.1	6.3	015334	030966	106466	015339	015342
35.0	35.4	2.0	4.1	6.3	015368	030967	105510	015372	015375
35.0	40.4	2.0	4.1	6.3	015398	030968	105203	015403	030969

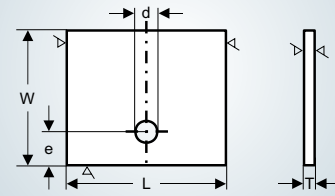

-  Blanks for profiling
-  Blanketts zum Profilieren
-  Plaquettes à profiler
-  Placchette da profilare
-  Placas para perfilar



L	W	T	d	e	T04F	T03SMG	T08CR	T10MG	TL15
mm	mm	mm	mm	mm					
15.0	15.4	2.0	4.1	6.5	014536	030982	106468	014540	030983
15.0	20.4	2.0	4.1	6.5	014554	014557	106469	014560	030984
15.0	25.4	2.0	4.1	6.5	014574	030985	106471	014578	014580
15.0	30.4	2.0	4.1	6.5	014591	030986	106472	014596	030987
16.0	20.4	2.0	4.1	6.5	014610	030988	105221	030989	030990
18.0	18.3	2.0	3.0	6.0	018849	030991	106473	030992	018850
20.0	20.4	1.5	4.1	6.5	040831		106474		040940
20.0	20.4	2.0	4.1	6.5	014649	014652	106475	014656	014659
20.0	25.4	2.0	4.1	6.5	014686	030993	106476	014694	014698
20.0	25.3	2.0	3.0	6.0	018851	030994	106477	030995	030996
20.0	30.4	2.0	4.1	6.5	014725	030997	106478	014731	014735
20.0	35.4	2.0	4.1	6.5	014751	030998	106479	014757	030999
20.0	40.4	2.0	4.1	6.5	031018	031019	106480	031020	012954
24.0	28.3	2.0	3.0	6.0	018852	031000	106481	031001	018853
25.0	25.4	2.0	4.1	6.5	014813	014817	106482	014820	014827
25.0	30.4	2.0	4.1	6.5	014849	014852	106483	014858	014863
25.0	30.4	2.0	5.8	6.5	019470				032399
25.0	35.4	2.0	4.1	6.5	014881	014884	106485	014888	014890
30.0	20.4	2.0	4.1	6.5	014918	031002	106486	014923	014927
30.0	25.4	2.0	4.1	6.5	014972	031003	106487	014982	014988
30.0	30.4	2.0	4.1	6.5	015047	015050	106488	015056	015060
30.0	30.4	2.0	6.0	6.5	019385		106490		032403
30.0	35.4	2.0	4.1	6.5	015106	031004	106491	015114	031005
30.0	40.4	2.0	4.1	6.5	015149	015151	106493	015155	015158
32.0	22.3	2.0	3.0	6.0	018855	031006	106494	031007	031008
35.0	20.4	2.0	4.1	6.5	015262	031009	106495	015266	031010
35.0	25.4	2.0	4.1	6.5	015287	031011	106496	015291	015294
35.0	30.4	2.0	4.1	6.5	015335	031012	106497	015340	031013
35.0	35.4	2.0	4.1	6.5	015369	031014	106498	015373	015376
35.0	40.4	2.0	4.1	6.5	015399	015401	106499	015404	015405
35.0	40.4	2.0	6.1	6.0	019731		106500		032407
40.0	30.3	2.0	3.0	6.0	018856	031015	106501	031016	031017



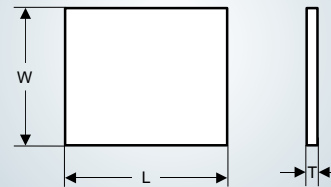

-  Blanks for profiling
-  Blanketts zum Profilieren
-  Plaquettes à profiler
-  Placchette da profilare
-  Placas para perfilar

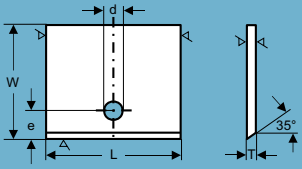

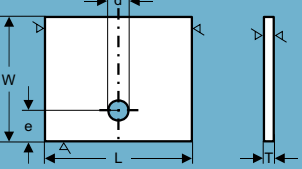
Italian Style



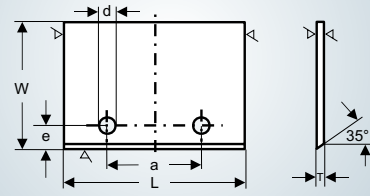

	L	W	T	d	e	T04F	T03SMG	T08CR	T10MG	TL15
	mm	mm	mm	mm	mm					
	15.0	15.4	2.0	4.5	6.5	031021	014545	106441	014547	031022
	15.0	20.4	2.0	4.5	6.5	034989	014566	106503	014569	031023
	15.0	25.4	2.0	4.5	6.5	034971	014584	106504	014585	031025
	15.0	30.4	2.0	4.5	6.5	034972	014604	103432	014606	031027
	20.0	20.4	2.0	4.5	6.5	034973	014664	106505	014665	031029
	20.0	25.4	2.0	4.5	6.5	034974	014706	106506	014708	031030
	20.0	30.4	2.0	4.5	6.5	034975	014739	106181	014741	031031
	20.0	35.4	2.0	4.5	6.5	034976	014762	106507	014764	031032
	25.0	20.4	2.0	4.5	6.5	034977	014797	106508	014799	031033
	25.0	25.4	2.0	4.5	6.5	034978	014832	106509	014834	031034
	25.0	30.4	2.0	4.5	6.5	034979	014869	106510	014871	031035
	25.0	35.4	2.0	4.5	6.5	034980	014893	106511	014895	031036
	30.0	20.4	2.0	4.5	6.5	034981	014932	106512	014935	031037
	30.0	25.4	2.0	4.5	6.5	034982	014993	106513	014995	031038
	30.0	30.4	2.0	4.5	6.5	034983	015064	106514	015068	031039
	30.0	35.4	2.0	4.5	6.5	034984	015122	106515	015124	031040
	35.0	25.4	2.0	4.5	6.5	034986	015299	106516	015301	031042
	35.0	30.4	2.0	4.5	6.5	034987	015345	106518	015347	031043

	L	W	T	d	e	T04F	T03SMG	T08CR	T10MG	TL15
	mm	mm	mm	mm	mm					
	15.0	20.4	2.0	4.5	6.5	034970	012955	106519	014570	031047
	15.0	25.4	2.0	4.5	6.5	034990	031045	106520	031046	014586
	15.0	30.4	2.0	4.5	6.5	034991	031049	106521	014607	031050
	20.0	20.4	2.0	4.5	6.5	034992	031051	106522	014666	014667
	20.0	25.4	2.0	4.5	6.5	034993	031053	106523	014709	014710
	20.0	30.4	2.0	4.5	6.5	034994	031056	106525	014742	014743
	20.0	35.4	2.0	4.5	6.5	034995	031058	106526	014765	031059
	25.0	20.4	2.0	4.5	6.5	041075	100453	106527	014800	041076
	25.0	25.4	2.0	4.5	6.5	034996	031061	106528	014835	014836
	25.0	30.4	2.0	4.5	6.5	034997	031063	106529	014872	031064
	25.0	35.4	2.0	4.5	6.5	038344	100454	106530	014896	041077
	30.0	20.4	2.0	4.5	6.5	034998	014933	106531	031066	031067
	30.0	25.4	2.0	4.5	6.5	038900	100455	106532	014996	041079
	30.0	30.4	2.0	4.5	6.5	015066	015065	106533	015069	031069
	30.0	35.4	2.0	4.5	6.5	042107	100458	106534	100456	100457
	30.0	40.4	2.0	4.5	6.5	042108	100460	106535	015163	100459

-  Blanks for profiling
-  Blanketts zum Profilieren
-  Plaquettes à profiler
-  Placchette da profilare
-  Placas para perfilar





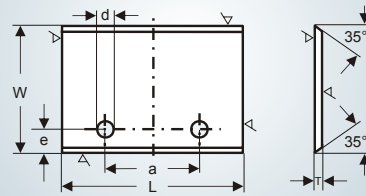

L mm	W mm	T mm	d mm	a mm	e mm	T04F	T03SMG	T08CR	T10MG	TL15
24.0	20.4	2.0	4.1	12.0	6.0	017436	041295	106537	041296	041297
30.0	20.4	2.0	4.1	14.0	6.0	017771	031072	106538	031073	031074
30.0	20.4	2.0	4.1	14.0	5.5	014937	031070	106539	014940	031071
30.0	20.4	2.0	4.1	14.0	6.3	039328	041232	106584	041233	041234
30.0	25.4	2.0	4.1	14.0	5.5	014999	012956	106541	012957	031167
30.0	25.4	2.0	4.1	14.0	6.3	015007	015008	106542	031075	015009
30.0	30.4	2.0	4.1	14.0	5.5	015072	031076	106543	031077	031078
30.0	30.4	2.0	4.1	14.0	6.3	039329	041235	106547	041236	041237
30.0	35.4	2.0	4.1	14.0	5.5	015125	031079	106550	031080	015130
30.0	35.4	2.0	4.1	14.0	6.3	019495	041238	106552	041239	041240
30.0	40.4	2.0	4.1	20.0	5.5	015164	031081	106554	031082	031083
31.8	25.4	2.0	4.1	16.0	6.3	041067	041348	106556	036909	041349
35.0	20.4	2.0	4.1	14.0	5.5	031085	031084	106557	031086	015276
35.0	20.4	2.0	4.1	20.0	5.5	031087	031088	106558	031089	015278
35.0	20.4	2.0	4.1	26.0	5.5	015274	031090	106560	031091	031092
35.0	25.4	2.0	4.1	26.0	5.5	015305	031093	106561	015311	015313
35.0	25.4	2.0	4.1	14.0	6.3	039575	041241	106562	041242	041243
35.0	25.4	2.0	4.1	18.0	6.3	019885	041335	106563	041336	041337
35.0	30.4	2.0	4.1	20.0	5.5	015356	031094	106564	031095	015357
35.0	30.4	2.0	4.1	14.0	6.3	039576	041244	104828	041245	041246
35.0	35.4	2.0	4.1	14.0	6.3	039577	041247	106566	041248	041249
35.0	40.4	2.0	4.1	20.0	5.5	015410	031096	106567	031097	015415
35.0	40.4	2.0	4.1	14.0	6.3	039578	041250	106568	041251	041252
40.0	20.4	2.0	4.1	26.0	5.5	015440	015443	106569	015447	015451
40.0	20.4	2.0	4.1	26.0	6.3	039566	041253	105622	041254	036345
40.0	25.4	2.0	4.1	20.0	5.5	015502	031098	106570	031099	031100
40.0	25.4	2.0	4.1	26.0	5.5	015482	015486	106572	015492	015497
40.0	25.4	2.0	4.1	26.0	6.0	017623	031101	106573	031102	031103
40.0	25.4	2.0	4.1	26.0	6.3	039330	041255	106097	041256	041257
50.0	20.4	2.0	4.1	26.0	6.3	039392	015821	106588	041265	036337
50.0	25.4	2.0	4.1	26.0	5.5	015841	015846	106589	015849	015852
50.0	25.4	2.0	4.1	26.0	6.3	039568	041266	104829	041267	036341

-  Blanks for profiling
-  Blanketts zum Profilieren
-  Plaquettes à profiler
-  Placchette da profilare
-  Placas para perfilar







L	W	T	d	a	e	T04F	T03SMG	T08CR	T10MG	TL15
mm	mm	mm	mm	mm	mm					
40.0	30.0	2.0	4.1	20.0	5.5	015542	015545	106575	015548	015553
40.0	30.0	2.0	4.1	26.0	5.5	015560	015563	106576	015566	015569
40.0	30.0	2.0	4.1	26.0	6.3	015571	041258	105656	041259	038185
40.0	35.0	2.0	4.1	26.0	5.5	015611	015613	106577	015620	015624
40.0	35.0	2.0	4.1	26.0	6.0	015629	031104	106578	031105	031106
40.0	35.0	2.0	4.1	20.0	5.5	015630	031107	106579	031108	015632
40.0	35.0	2.0	4.1	26.0	6.3	039331	041260	104665	041261	041262
40.0	40.0	2.0	4.1	26.0	6.0	015646	031109	106580	015649	015652
40.0	40.0	2.0	4.1	20.0	6.0	015655	015658	106582	015659	031110
40.0	40.0	2.0	4.1	26.0	6.3	039567	041263	105990	041264	038186
40.0	45.0	2.0	4.1	26.0	6.0	019372	041333	106583	041334	019373
50.0	16.0	2.0	4.1	26.0	5.5	017639	031111	106585	031112	031113
50.0	16.0	2.0	4.1	26.0	6.0	015794	031114	106586	015796	031115
50.0	20.0	2.0	4.1	26.0	5.5	015804	031116	106587	031117	015815
50.0	30.0	2.0	4.1	26.0	5.5	015871	015874	106590	015878	015880
50.0	30.0	2.0	4.1	26.0	6.3	039569	038369	105657	015884	038188
50.0	35.0	2.0	4.1	26.0	6.0	015904	031120	106592	031121	031122
50.0	35.0	2.0	4.1	26.0	5.5	015905	031123	106593	031124	031125
50.0	35.0	2.0	4.1	26.0	6.3	018387	041268	105204	041269	041270
50.0	40.0	2.0	4.1	34.0	6.0	015916	031126	106594	031127	031128
50.0	40.0	2.0	4.1	26.0	6.3	019030	041271	105989	041272	035746
50.0	45.0	2.0	4.1	34.0	6.0	015940	015942	106595	031129	031130
50.0	45.0	2.0	4.1	26.0	6.3	039579	041273	106596	041274	041275
50.0	50.0	2.0	4.1	34.0	6.0	015953	031131	106597	031132	031133
60.0	20.0	2.0	4.1	26.0	5.5	016001	031134	106599	031135	031136
60.0	25.0	2.0	4.1	26.0	5.5	016031	031140	106601	016037	016040
60.0	25.0	2.0	4.1	44.0	5.5	016046	031141	106602	016047	031142
60.0	30.0	2.0	4.1	26.0	6.0	016068	031143	106603	031144	016074
60.0	30.0	2.0	4.1	26.0	6.3	039571	041276	104861	016082	038189
60.0	30.0	2.0	4.1	44.0	6.0	016076	031145	106604	031146	016077
60.0	35.0	2.0	4.1	26.0	6.0	016114	031147	106605	016119	016123
60.0	35.0	2.0	4.1	26.0	6.3	039572	041277	104859	041278	038190
60.0	35.0	2.0	4.1	44.0	6.0	016126	031148	106606	031149	031150
60.0	40.0	2.0	4.1	26.0	6.3	039573	041279	106098	041280	036782
60.0	40.0	2.0	4.1	44.0	6.0	016158	016164	106607	016170	016175
60.0	45.0	2.0	4.1	44.0	6.0	019375	019374	106609	031151	019376
75.0	30.0	2.0	4.1	44.0	6.0	016258	031152	106610	031153	031154
80.0	30.0	2.0	4.1	60.0	6.3	039580	041283	106003	041284	041285
80.0	35.0	2.0	4.1	60.0	6.3	041286	041287	106273	041288	041289
80.0	40.0	2.0	4.1	60.0	6.3	041292	041293	106612	041294	035745
80.0	45.0	2.5	4.1	60.0	6.0	016321	031155	106613	016323	016324
100.0	45.0	2.5	4.2	80.0	6.0	014519	031159	105295	031160	031161
120.0	45.0	2.5	4.2	80.0	6.0	014528	031165	106615	031166	014529

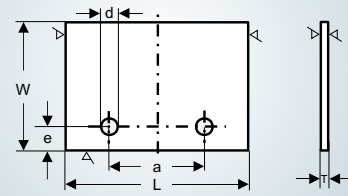

-  Blanks for profiling
-  Blanketts zum Profilieren
-  Plaquettes à profiler
-  Placchette da profilare
-  Placas para perfilar





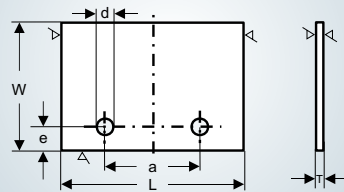

L mm	W mm	T mm	d mm	a mm	e mm	T04F	T03SMG	T08CR	T10MG	TL15
19.0	30.0	2.0	3.6	8.0	4.75	017790	031963	106616	031964	031965
25.4	30.6	2.0	3.6	14.3	4.75	017791	031966	106617	031967	031968
30.0	20.4	2.0	4.1	14.0	6.5	014938	014939	106621	014941	014943
30.0	25.4	2.0	4.1	14.0	6.5	015000	015001	106622	015003	015005
30.0	25.4	2.0	4.1	19.0	4.75	017603	031969	106623	031970	017604
30.0	25.4	2.0	4.1	19.0	6.5	019428	031971	106624	031972	031973
30.0	30.4	2.0	4.1	14.0	6.5	015073	015074	106625	015077	015078
30.0	30.2	2.0	4.1	19.0	4.75	017605	031974	106626	031975	031976
30.0	30.0	2.0	3.6	19.0	4.75	017785	031977	106627	031978	017787
30.0	35.4	2.0	6.0	12.0	6.0	033964	041327	106628	041328	041329
30.0	35.4	2.0	4.1	14.0	6.5	015126	015127	106629	015129	015132
30.0	40.4	2.0	4.1	14.0	6.5	015165	015166	106630	031979	031981
35.0	20.4	2.0	4.1	14.0	6.5	015275	031988	106631	031989	031990
35.0	25.4	2.0	4.1	14.0	6.5	015306	015308	106632	015312	015314
35.0	30.4	2.0	4.1	14.0	6.5	015351	031991	106633	015354	031992
35.0	35.4	2.0	4.1	20.0	4.8	019831	041330	106634	041331	041332
35.0	35.4	2.0	4.1	14.0	6.5	015383	031993	106635	015385	015386
35.0	40.4	2.0	4.1	14.0	6.5	015411	015412	106636	015414	015416
40.0	20.4	2.0	5.5	26.0	5.5	037885	041338	106637	041339	041340
40.0	20.4	2.0	4.1	26.0	6.5	015441	015444	106638	015448	015452
40.0	25.4	2.0	4.1	26.0	6.5	015484	015487	106639	015493	015499
40.0	30.2	2.0	5.0	27.0	6.3	035290	041298	106640	041299	039325
40.0	30.4	2.0	4.1	26.0	6.5	015544	031994	106642	015550	015554
40.0	30.4	2.0	6.0	26.0	5.5	019253		106643		032414
40.0	35.4	2.0	5.0	27.0	6.3	018955	041300	106644	041301	041302
40.0	35.4	2.0	4.1	26.0	6.5	015612	015614	106645	015622	015625
40.0	35.4	2.0	6.0	26.0	5.5	019471		106646		032415
40.0	40.2	2.0	5.0	27.0	6.3	019002	041303	106647	041304	041305
40.0	40.4	2.0	4.1	26.0	6.5	015647	031995	106648	015650	015654
40.0	40.4	2.0	6.0	26.0	5.5	019254		106649		032416
40.0	45.4	2.0	4.1	26.0	6.5	015676	031996	106650	015677	031997

-  Blanks for profiling
-  Blanketts zum Profilieren
-  Plaquettes à profiler
-  Placchette da profilare
-  Placas para perfilar



L mm	W mm	T mm	d mm	a mm	e mm	T04F	T03SMG	T08CR	T10MG	TL15
50.0	20.4	2.0	4.1	26.0	6.5	015805	015808	106651	015813	015817
50.0	20.4	2.0	4.1	24.0	6.0	019600	041341	106652	041342	041343
50.0	25.2	2.0	5.0	26.0	6.5	019065	041306	106653	041307	041308
50.0	25.4	2.0	4.1	26.0	6.5	015843	015847	106654	015850	015854
50.0	30.4	2.0	4.1	26.0	6.5	015872	015875	106655	015879	032001
50.0	30.4	2.0	6.0	26.0	6.5	019382		106656		032422
50.0	32.4	2.0	3.0	24.0	6.0	018857	031998	106657	031999	032000
50.0	35.4	2.0	4.1	26.0	6.5	015897	015898	106658	015902	032002
50.0	40.4	2.0	4.1	26.0	6.5	015917	032003	106659	015920	015922
50.0	40.4	2.0	6.0	26.0	6.5	019383		106660		032424
50.0	45.4	2.0	4.1	26.0	6.5	015941	032004	106661	032005	032006
50.0	50.4	2.0	4.1	26.0	6.5	015954	015955	106663	015956	032007
60.0	20.4	2.0	4.1	26.0	6.5	016002	016003	106664	016007	032009
60.0	25.4	2.0	4.1	26.0	6.5	016033	032010	106665	016038	016042
60.0	30.4	2.0	4.1	26.0	6.5	016069	016070	106666	016072	032011
60.0	35.4	2.0	4.1	26.0	6.5	016116	032012	106667	016121	016125
60.0	40.4	2.0	4.1	26.0	6.5	016160	032013	106668	016172	016177
80.0	25.2	2.0	4.1	60.0	6.5	035291	041309	106669	041310	041311
80.0	30.4	2.0	4.1	26.0	6.5	016276	032014	106670	016279	016281
80.0	35.4	2.0	4.1	26.0	6.5	016290	032015	106672	016292	032016



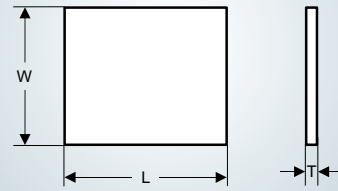

-  Blanks for profiling
-  Blanketts zum Profilieren
-  Plaquettes à profiler
-  Placchette da profilare
-  Placas para perfilar

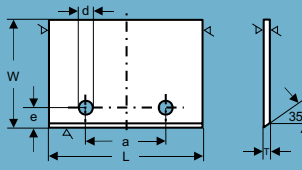

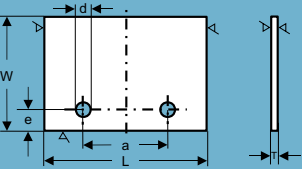
Italian Style

	L mm	W mm	T mm	d mm	a mm	e mm	T04F	T03SMG	T08CR	T10MG	TL15
	30.0	25.4	2.0	4.5	14.0	6.5	035066	015013	106686	015015	031590
	30.0	30.4	2.0	4.5	14.0	6.5	012981	015084	106687	015088	031591
	30.0	35.4	2.0	4.5	14.0	6.5	035069	015134	106688	015136	031592
	40.0	20.4	2.0	4.5	26.0	6.5	012982	015457	106689	015460	031597
	40.0	25.4	2.0	4.5	26.0	6.5	035073	015504	106690	015508	031598
	40.0	30.4	2.0	4.5	26.0	6.5	035075	015574	106691	015577	031599
	50.0	20.4	2.0	4.5	26.0	6.5	035078	015823	106692	015826	031600
	50.0	35.4	2.0	4.5	26.0	6.5	035082	015907	106693	015909	031601
	60.0	20.4	2.0	4.5	26.0	6.5	035084	016010	106694	016012	031603
	60.0	30.4	2.0	4.5	26.0	6.5	016084	043981	106695	016086	041090
	60.0	35.4	2.0	4.5	26.0	6.5	035086	016130	106696	016132	031604
	80.0	20.4	2.0	4.5	26.0	6.5	035089	016264	106697	031607	031608
80.0	25.4	2.0	4.5	26.0	6.5	035090	016270	106698	016272	031609	



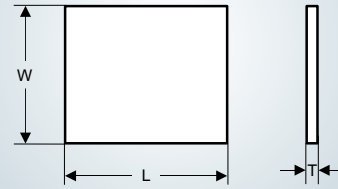

	L mm	W mm	T mm	d mm	a mm	e mm	T04F	T03SMG	T08CR	T10MG	TL15
	30.0	20.4	2.0	4.5	14.0	6.5	014947	100044	106699	050284	050285
	30.0	25.4	2.0	4.5	14.0	6.5	035067	031610	106700	031612	015016
	30.0	30.4	2.0	4.5	14.0	6.5	015085	033517	106701	015086	015089
	30.0	35.4	2.0	4.5	14.0	6.5	035070	031615	106703	031616	015137
	35.0	25.4	2.0	4.5	14.0	6.5	015320	040122	106704	050286	015321
	35.0	30.4	2.0	4.5	14.0	6.5	042115	054676	106705	050287	050288
	35.0	35.4	2.0	4.5	14.0	6.5	015389	100326	106706	050289	015390
	40.0	20.4	2.0	4.5	26.0	6.5	015458	100327	106707	015461	041094
	40.0	25.4	2.0	4.5	26.0	6.5	035074	031617	106708	015509	031643
	40.0	30.4	2.0	4.5	26.0	6.5	035076	015575	106709	015578	015579
	40.0	35.4	2.0	4.5	26.0	6.5	012980	015635	106710	031621	015638
	40.0	40.4	2.0	4.5	26.0	6.5	035077	031623	106711	015667	015668
	50.0	20.4	2.0	4.5	26.0	6.5	035079	015824	106712	015827	015860
	50.0	25.4	2.0	4.5	26.0	6.5	035080	031626	106713	031627	012974
	50.0	30.4	2.0	4.5	26.0	6.5	035081	031629	106714	015889	015890
	50.0	35.4	2.0	4.5	26.0	6.5	042117	040132	106715	050290	050291
	50.0	40.4	2.0	4.5	26.0	6.5	042118	040133	106716	015927	050292
	60.0	20.4	2.0	4.5	26.0	6.5	035085	031630	106717	016013	031632
	60.0	25.4	2.0	4.5	26.0	6.5	041095	040135	106718	036875	041096
	60.0	30.4	2.0	4.5	26.0	6.5	042121	100765	106719	050282	050283
	60.0	35.4	2.0	4.5	26.0	6.5	035087	031633	106720	016133	031636
	60.0	40.4	2.0	4.5	26.0	6.5	042122	100332	106721	050293	050294
	80.0	30.4	2.0	4.5	26.0	6.5	035091	031637	106722	016286	031639
	80.0	35.4	2.0	4.5	26.0	6.5	035092	031641	106723	016300	031640
80.0	40.4	2.0	4.5	26.0	6.5	042124	100333	106724	100334	100335	

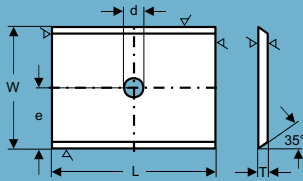
-  Blanks for profiling
-  Blanketts zum Profilieren
-  Plaquettes à profiler
-  Placchette da profilare
-  Placas para perfilar

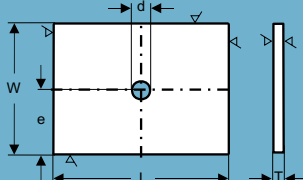

	L	W	T	d	a	e	T04F	T03SMG	T10MG	TL15
	mm	mm	mm	mm	mm	mm				
	13.0	14.0	1.5	3.2			015189	033193	033194	033195
	20.0	12.0	2.0	4.1			014618		052454	014620
	13.0	16.0	2.0	3.0			017504	031647	031648	031649
	13.0	16.0	2.0	4.0			018566			
	20.0	16.0	2.0	3.0			014631	031650	031651	031652
	20.0	20.0	2.0	4.1			014636	031653	014638	014640
	20.0	24.0	2.0	3.5			014674	031654	031655	031656
	25.0	16.0	2.0	4.1			014776	031657	031658	031659
	25.0	25.0	2.0	4.1			014805	031660	031661	031662
	30.0	20.0	2.0	4.1			014913	031663	031664	031665
	30.0	26.0	2.0	4.1			015020	031666	031667	031668
	40.0	25.0	2.0	4.1			015469	031672	031673	031674



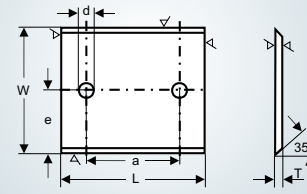

	L	W	T	d	a	e	T04F	T03SMG	T10MG	TL15
	mm	mm	mm	mm	mm	mm				
	15.0	15.0	2.0	4.1			014532	031675	031676	031677
	20.0	12.0	2.0	4.1			014619	031678	031679	031680
	20.0	20.0	2.0	4.1			014637	031681	014639	014641
	24.0	22.0	2.0	3.0			018841	031688	031689	031690
	28.0	24.0	2.0	3.0			018842	031692	031693	031694
	30.0	20.0	2.0	4.1			014914	031682	031683	031684
	32.0	24.0	2.0	3.0			018843	031695	031696	031697
	35.0	30.0	2.0	4.1			015328	031685	031686	031687
	36.0	28.0	2.0	3.0			018844	031700	031699	031698

-  Blanks for profiling
-  Blanketts zum Profilieren
-  Plaquettes à profiler
-  Placchette da profilare
-  Placas para perfilar



L mm	W mm	T mm	d mm	a mm	e mm	T04F	T03SMG	T10MG	TL15
30.0	16.0	2.0	4.0	20.0		014906	031706	014907	031707
30.0	25.0	2.0	3.5	20.0		014956	014958	014962	014965
30.0	25.0	2.0	3.0	20.0		017496	031708	031709	031710
30.0	26.0	2.0	3.5	20.0		015022	031711	031712	031713
30.0	35.0	2.0	4.1	20.0		015098	031714	031715	031716
40.0	16.0	2.0	4.1	26.0		015429	031717	031718	015430
40.0	20.0	2.0	4.1	20.0		015434	015435	031719	031720
40.0	20.0	2.0	4.1	26.0		015436	015437	031721	031722
40.0	25.0	2.0	4.1	20.0		015473	031723	031724	031725
40.0	25.0	2.0	4.1	26.0		015475	015476	031726	031727
40.0	30.0	2.0	3.5	20.0		015518	015521	015523	015526
40.0	30.0	2.0	4.1	20.0		015530	031728	031729	031730
40.0	30.0	2.0	4.1	26.0		015529	031731	031732	031733
40.0	32.62	2.0	3.5	20.0		015583	031734	031735	015587
40.0	35.0	2.0	4.1	20.0		015590	031736	031737	015592
40.0	35.0	2.0	4.1	26.0		015595	015596	015600	015603
40.0	37.82	2.0	3.5	20.0		015639	031738	031739	031740
40.0	40.0	2.0	4.1	20.0		015641	031741	031742	031743
40.0	40.0	2.0	3.5	20.0		015643	031744	031745	031746
40.0	42.86	2.0	3.5	20.0		015671	031747	031748	031749
45.0	30.0	2.0	4.1	26.0		015781	031750	031751	031752
50.0	16.0	2.0	4.1	26.0		015788	015789	031753	031754
50.0	20.0	2.0	4.1	26.0		015800	031755	031756	031757
50.0	25.0	2.0	4.1	26.0		015838	031758	031759	015836
50.0	30.0	2.0	4.1	26.0		015867	031760	031761	031762
50.0	45.0	2.0	4.1	34.0		015931	015933	015935	031766





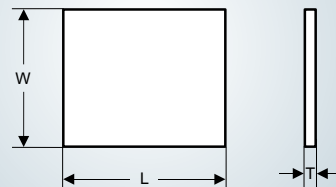

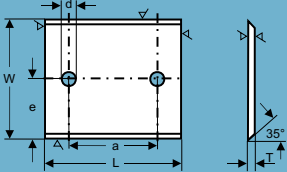
-  Blanks for profiling
-  Blanketts zum Profilieren
-  Plaquettes à profiler
-  Placchette da profilare
-  Placas para perfilar

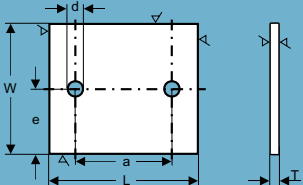







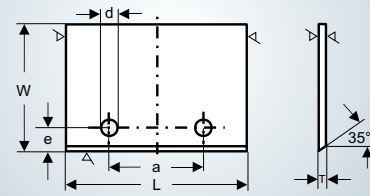

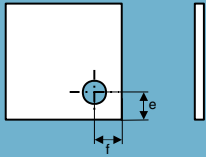

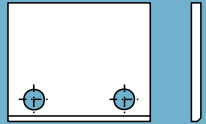
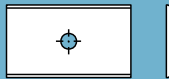
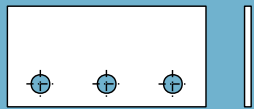
	L mm	W mm	T mm	d mm	a mm	e mm	T04F	T03SMG	T10MG	TL15
	60.0	20.0	2.0	4.1	26.0		015992	031770	015995	015996
	60.0	25.0	2.0	4.1	26.0		016022	031771	031772	016024
	60.0	24.0	2.0	4.1	36.0		016027	031773	031774	031775
	60.0	32.62	2.0	3.5	20.0		016089	031776	031777	031778
	60.0	35.0	2.0	4.1	26.0		016091	016092	031779	016095
	60.0	35.0	2.0	4.1	44.0		016098	016102	016104	016107
	60.0	37.82	2.0	3.5	20.0		016137	031780	031781	031782
	60.0	39.0	2.0	3.5	20.0		016138	031783	031784	016140
	60.0	40.0	2.0	4.1	44.0		016145	016148	016149	016151
	60.0	42.86	2.0	3.5	20.0		016184	031785	031786	031787
	80.0	24.0	2.0	4.1	60.0		016265			
	80.0	45.0	2.5	4.1	60.0		016317	016318	031794	031795

	L mm	W mm	T mm	d mm	a mm	e mm	T04F	T03SMG	T10MG	TL15
	30.0	25.0	2.0	4.1	14.0		014957	031798	031799	031800
	30.0	30.0	2.0	4.1	14.0		015035	031801	031802	031803
	30.0	35.0	2.0	4.1	14.0		015099	031804	031805	031806
	40.0	30.0	2.0	4.1	26.0		015519	031807	031808	031809
	50.0	40.0	2.0	4.1	26.0		015913	031822	031823	031824
	60.0	30.0	2.0	4.1	26.0		016061	016062	031825	031826
	60.0	40.0	2.0	4.1	26.0		016147	031827	016150	031828

-  Special blanks for profiling
-  Spezial-Blanketts zum Profilieren
-  Plaquettes spéciales à profiler
-  Placchette speciali da profilare
-  Placas especiales para perfilar



	L mm	W mm	T mm	d mm	a mm	e mm	f mm	T04F
	20.4	20.4	1.5	4.2		6.3	6.3	019915
	20.4	27.6	1.5	4.2		6.3	6.3	019916
	20.5	20.5	2.0	5.0		5.0	5.0	018084
	25.5	20.5	2.0	5.0		6.0	6.0	018434
	25.5	25.0	2.0	5.0		6.0	6.0	018546
	25.5	25.5	2.0	5.0		6.0	6.0	018086
	28.0	32.2	2.0	5.0		6.0	6.0	018536
	40.0	50.2	2.0	4.5x7.0	27.0	7.5		035289
	40.0	60.2	2.0	4.5x7.0	27.0	7.5		019068
	60.0	25.2	2.0	7.0x4.5	45.5	6.3		037415
	60.0	30.2	2.0	7.0x4.5	45.5	6.3		035292
	60.0	40.2	2.0	7.0x4.5	45.5	6.3		035293
	30.0	25.0	2.0	4.1	19.0	4.6		018068
	30.0	27.0	2.0	4.1	19.0	4.6		018467
	30.0	40.5	2.0	4.1	19.0	4.5		018602
	35.0	27.0	2.0	4.1	19.0	4.6		018074
	40.0	27.5	2.0	4.1	27.5	4.6		018367
	40.0	27.5	2.0	4.1	19.0	4.6		018453
	40.0	40.5	2.0	4.1	19.0	4.6		018605
	50.0	20.5	2.0	4.1	26.0	6.0		019113
	50.0	27.5	2.0	4.1	26.0	4.6		018364
50.0	27.5	2.0	4.1	26.0	6.0		018277	
	36.0	21.0	2.0	4.4				017583
	60.0	30.4	2.0	5.6	20.0	7.0		019162
	60.0	35.4	2.0	5.6	20.0	7.0		019472
	60.0	40.4	2.0	5.6	20.0	7.0		019163
	80.0	30.4	2.0	5.6	20.0	7.0		019164
	80.0	35.4	2.0	5.6	20.0	7.0		019473
	80.0	40.4	2.0	5.6	20.0	7.0		019165
	80.0	27.0	2.0	4.1	67.0			032388
	37.5	25.4	1.5					019140
	50.0	25.4	1.5					018343



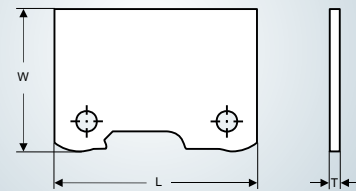

-  Blanks for profiling
-  Blanketts zum Profilieren
-  Plaquettes à profiler
-  Placchette da profilare
-  Placas para perfilar

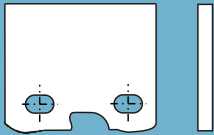
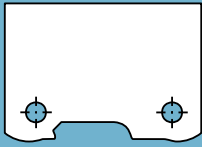
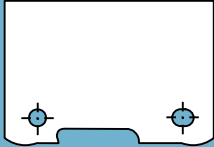
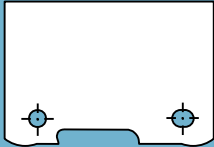
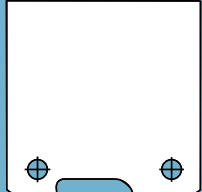

For Leuco  
Superprofiler system\*

	L mm	W mm	T mm	T04F	T03SMG	T08CR	T10MG	TL15		
	31.0	26.0	1.5	015207	015210	106725	015211	015214		
	41.0	28.0	1.5	015701	015708	102763	015722	015727		
	41.0	28.0	2.0	015695	031835	106726	031837	031839		
	41.0	35.0	1.5	015748	015750	106727	015751	015753		
	41.0	35.0	2.0	015744	031840	106728	015745	015746		
	51.0	35.0	1.5	015973	031841	106729	015975	015978		
	51.0	45.0	2.0	015981	015984	106730	031842	031843		
	60.8	30.6	1.5	016209	016214	106731	016225	016229		
	60.8	30.6	2.0	016206	031844	106732	031846	016208		
	61.0	45.0	2.0	016234	016238	106733	016239	016242		
	81.0	45.0	2.0	016334	031847	106734	016336	016339		
	L mm	W mm	T mm	d mm	e mm	T04F	T03SMG	T08CR	T10MG	TL15
	40.4	41.2	2.0	4.1	6.0	015756		106735		
	40.4	41.2	2.0	5.1	8.0	033424	053741	106736	033503	042598

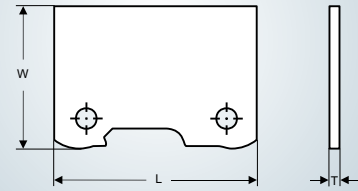

\* For use in Leuco-cutterheads only  
 \* Nur zur Verwendung in Messerköpfen der Firma Leuco  
 \* Utilisation limitée aux porte outils de l'entreprise Leuco  
 \* Da usare solo su teste portacottelli della Leuco  
 \* Sólo para empleo con portacuchillas de la firma Leuco

-  Blanks for profiling
-  Blanketts zum Profilieren
-  Plaquettes à profiler
-  Placchette da profilare
-  Placas para perfilar





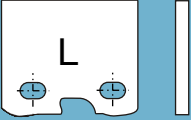
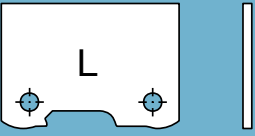

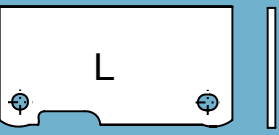
For Leuco  
Superprofiler system\*

>>>MICROFINISH<<<

		L mm	W mm	T mm	T04F	T03SMG	T10MG	TL15
	L	31.0	26.0	1.5	032077	032076	015212	032074
	R	31.0	26.0	1.5	015208	032072	015213	032073
	L	41.0	28.0	1.5	015707	015711	015724	015730
	R	41.0	28.0	1.5	015702	015709	015723	015728
	L	41.0	28.0	2.0	031848	031849	031852	031854
	R	41.0	28.0	2.0	015696	031850	031853	031855
	L	41.0	35.0	1.5	032028	032029	032027	032030
	R	41.0	35.0	1.5	032031	032032	015752	032033
	L	41.0	35.0	2.0	032034	032037	032038	032041
	R	41.0	35.0	2.0	032035	032036	032039	032040
	L	51.0	35.0	1.5	034084	034085	034086	034087
	R	51.0	35.0	1.5	032043	032044	032045	032046
	L	51.0	45.0	2.0	034088	034089	034090	034091
	R	51.0	45.0	2.0	015982	032047	032048	032049
	L	60.8	30.6	1.5	032051	032053	032054	032055
	R	60.8	30.6	1.5	032050	032052	016226	032056
	L	60.8	30.6	2.0	032058	032059	032063	032062
	R	60.8	30.6	2.0	032057	032060	032064	032061
	L	61.0	45.0	2.0	034092	034093	034094	034095
	R	61.0	45.0	2.0	016235	032065	032066	016243
	L	81.0	45.0	2.0	034096	034097	034098	034099
	R	81.0	45.0	2.0	032067	032068	032069	032070



L: Left, links, gauche, sinistra, izquierda  
R: Right, rechts, droite, destra, derecha

\* For use in Leuco-cutterheads only  
 \* Nur zur Verwendung in Messerköpfen der Firma Leuco  
 \* Utilisation limitée aux porte outils de l'entreprise Leuco  
 \* Da usare solo su teste portacottelli della Leuco  
 \* Sólo para empleo con portacuchillas de la firma Leuco

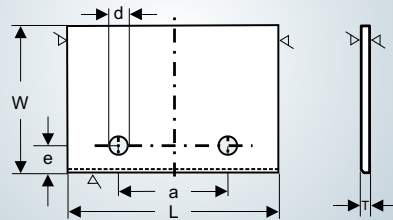
-  Blanks for profiling
-  Blanketts zum Profilieren
-  Plaquettes à profiler
-  Placchette da profilare
-  Placas para perfilar



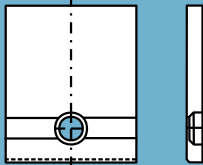
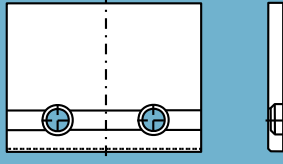



For Freud system\*

	L mm	W mm	T mm	d mm	a mm	e mm	T04F	T08CR	T10MG
	20.0	25.0	3.0	4.5		7.0	018786	115151	031880
	25.0	25.0	3.0	4.5		7.0	031882	115152	031884
	25.0	30.0	3.0	4.5		7.0	031886	115153	031887
	25.0	35.0	3.0	4.5		7.0	018798	115154	031890
	25.0	40.0	3.0	4.5		7.0	031892	115155	031893
	30.0	40.0	3.0	4.5		7.0	031958	115156	031959
	35.0	25.0	3.0	4.5		7.0	031896	115157	031897
	35.0	30.0	3.0	4.5		7.0	031900	115158	031901
	35.0	35.0	3.0	4.5		7.0	018810	115159	031904
	45.0	25.0	3.0	4.5	28.0	7.0	031907	115160	031908
	45.0	30.0	3.0	4.5	28.0	7.0	031911	115161	031912
	45.0	35.0	3.0	4.5	28.0	7.0	031915	115162	031916
	55.0	25.0	3.0	4.5	41.0	6.0	031919	115163	031920
	55.0	30.0	3.0	4.5	41.0	6.0	031924	115164	031923
	55.0	35.0	3.0	4.5	41.0	6.0	031927	115165	031928
	55.0	40.0	3.0	4.5	41.0	6.0	031931	115166	031932
	65.0	20.0	3.0	4.5	28.0	6.0	031935	115167	031936
	65.0	25.0	3.0	4.5	28.0	6.0	031955	115168	018826
	70.0	25.0	3.0	4.5	41.0	6.0	031939	115169	031940
	80.0	30.0	3.0	4.5	66.0	6.0	031943	115170	031944
	80.0	35.0	3.0	4.5	66.0	6.0	031947	115171	031948
	40.0	40.0	3.0	4.5		11/11	031951	115150	031952



\* For use in Freud-cutterheads only  
 \* Nur zur Verwendung in Messerköpfen der Firma Freud  
 \* Utilisation limitée aux porte outils de l'entreprise Freud  
 \* Da usare solo su teste portacottelli della Freud  
 \* Sólo para empleo con portacuchillas de la firma Freud

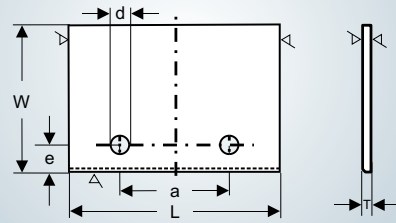

-  Blanks for profiling
-  Blanketts zum Profilieren
-  Plaquettes à profiler
-  Placchette da profilare
-  Placas para perfilar

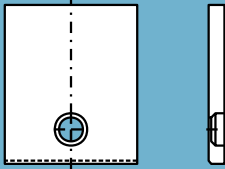
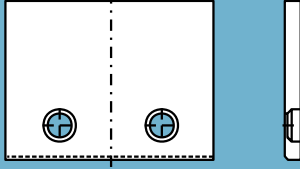

For Freud system\*

	L mm	W mm	T mm	d mm	a mm	e mm	T04F	T08CR	T10MG
	20.0	25.0	3.0	4.5		7.0	052171	110903	052173
	25.0	25.0	3.0	4.5		7.0	052044	115130	052176
	25.0	30.0	3.0	4.5		7.0	052178	115131	052180
	25.0	35.0	3.0	4.5		7.0	052182	115132	052184
	25.0	40.0	3.0	4.5		7.0	051951	115133	052190
	30.0	40.0	3.0	4.5		7.0	052192	115134	052194
	35.0	25.0	3.0	4.5		7.0	052196	115135	052198
	35.0	30.0	3.0	4.5		7.0	052200	115136	052202
	35.0	35.0	3.0	4.5		7.0	052204	115137	052206
	45.0	25.0	3.0	4.5	28.0	7.0	052208	115138	052210
	45.0	30.0	3.0	4.5	28.0	7.0	052213	115139	052214
	45.0	35.0	3.0	4.5	28.0	7.0	052216	115140	052218
	55.0	25.0	3.0	4.5	41.0	6.0	052220	115141	052222
	55.0	30.0	3.0	4.5	41.0	6.0	051712	115142	052225
	55.0	35.0	3.0	4.5	41.0	6.0	052227	115143	052229
	55.0	40.0	3.0	4.5	41.0	6.0	052231	115144	052235
	65.0	20.0	3.0	4.5	28.0	6.0	052236	115145	052238
	65.0	25.0	3.0	4.5	28.0	6.0	052240	115146	052242
	70.0	25.0	3.0	4.5	41.0	6.0	052244	115147	052246
	80.0	30.0	3.0	4.5	66.0	6.0	052248	115148	052250
	85.0	35.0	3.0	4.5	66.0	6.0	052251	115149	052253
	40.0	40.0	3.0	4.5		11/11	031951	115150	031952





\* For use in Freud-cutterheads only

\* Nur zur Verwendung in Messerköpfen der Firma Freud

\* Utilisation limitée aux porte outils de l'entreprise Freud



\* Da usare solo su teste portacottelli della Freud

\* Sólo para empleo con portacuchillas de la firma Freud

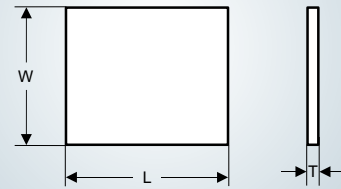

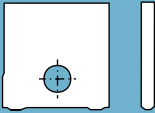

-  Blanks for profiling
-  Blanketts zum Profilieren
-  Plaquettes à profiler
-  Placchette da profilare
-  Placas para perfilar

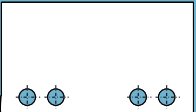

For Leuco  
ECO-PRO system\*

	L mm	W mm	T mm	T04F	T03SMG	T10MG	TL15
	10.6	20.8	2.0	032288	032343	032344	032345
	12.5	20.5	2.0	032346	032385	032386	032387
	15.5	20.5	2.0	032347	032390	032456	032495
	15.5	25.5	2.0	032352	032393	032457	032496
	16.4	20.5	2.0	032353	032406	032458	032497
	16.7	25.9	2.0	032354	032408	032459	032498
	18.4	18.9	2.0	032355	032409	032460	032499
	18.4	25.9	2.0	032356	032410	032461	032500
	18.4	36.3	2.0	032357	032412	032462	032501
	20.3	20.5	2.0	032358	032421	032463	032502
	20.3	25.5	2.0	032359	032423	032464	032503
	20.3	30.4	2.0	032360	032425	032465	032504
	22.3	25.5	2.0	032361	032433	032466	032505
	24.3	20.9	2.0	032362	032434	032467	032506
	25.3	25.9	2.0	032363	032435	032468	032507
	25.3	35.3	2.0	032364	032436	032469	032508
28.2	25.5	2.0	032365	032437	032470	032509	
28.2	35.3	2.0	032366	032438	032471	032511	
	30.2	25.5	2.0	032348	032349	032350	032351
	30.2	30.4	2.0	032367	032439	032478	032523
	32.2	22.8	2.0	032368	032440	032479	032524
	32.2	35.4	2.0	032369	032441	032480	032525
	32.8	26.0	2.0	032370	032442	032481	032526
	35.2	26.0	2.0	032371	032443	032482	032527
	40.1	20.9	2.0	032372	032444	032483	032528
	40.1	30.4	2.0	032373	032445	032484	032529
	40.8	36.0	2.0	032374	032446	032485	032530
	42.8	31.0	2.0	032375	032447	032486	032531
	42.8	36.0	2.0	032376	032448	032487	032532
	45.8	36.0	2.0	032377	032449	032488	032533
	49.9	20.9	2.0	032378	032450	032489	032534
	49.9	33.0	2.0	032379	032451	032490	032535
	49.9	40.2	2.0	032380	032452	032491	032536
	60.6	25.8	2.0	032382	032454	032493	032538
80.6	35.8	2.0	032384	032455	032494	032539	
	59.6	35.4	2.0	032381	032453	032492	032537

\* For use in Leuco-cutterheads only  
 \* Nur zur Verwendung in Messerköpfen der Firma Leuco  
 \* Utilisation limitée aux porte outils de l'entreprise Leuco  
 \* Da usare solo su teste portacoltelli della Leuco  
 \* Sólo para empleo con portacuchillas de la firma Leuco

-  Blanks for profiling
-  Blanketts zum Profilieren
-  Plaquettes à profiler
-  Placchette da profilare
-  Placas para perfilar

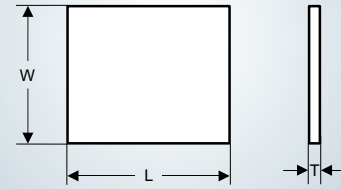

For Oertli system\*

Also available with Microfinish!  
Auch mit Microfinish erhältlich!

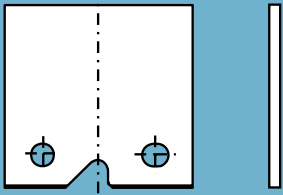
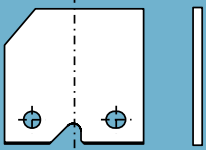
	L mm	W mm	T mm	T04F	T10MG
	20.0	20.0	2.0	032078	032080
	20.0	24.0	2.0	022563	022565
	20.0	29.0	2.0	022567	022568
	20.0	34.0	2.0	032083	022571
	25.0	19.0	2.0	032085	032086
	25.0	24.0	2.0	022577	022578
	25.0	29.0	2.0	022581	022583
	25.0	34.0	2.0	022558	022559
	30.0	19.0	2.0	032098	032100
	30.0	24.0	2.0	022586	032093
	30.0	29.0	2.0	032094	032095
	30.0	34.0	2.0	022611	022612
	35.0	24.0	2.0	022588	022589
	35.0	29.0	2.0	022592	022594
	35.0	34.0	2.0	032103	032104
	45.0	19.0	2.0	022575	022576
	45.0	24.0	2.0	022596	022597
	45.0	29.0	2.0	022600	022602
	45.0	33.0	2.0	032108	022604
	45.0	34.0	2.0	032110	032111
	55.0	19.0	2.0	032116	032118
	55.0	22.0	2.0	032113	035199
	55.0	27.5	2.0	032119	032120
	55.0	29.6	2.0	032122	035204
55.0	33.0	2.0	022605	022606	
65.0	22.0	2.0	032125	032126	
65.0	27.5	2.0	032128	032130	
65.0	33.0	2.0	022609	032131	
80.0	22.0	2.0	032133	032134	
80.0	27.5	2.0	032136	032137	
80.0	33.0	2.0	032141	032140	
	25.0	29.0-50°	2.0	022617	022620
	25.0	29.0-70°	2.0	022624	022628
	35.0	29.0-50°	2.0	032142	032143
	35.0	29.0-70°	2.0	032145	032146





\* For use in Oertli-cutterheads only

\* Nur zur Verwendung in Messerköpfen der Firma Oertli

\* Utilisation limitée aux porte outils de l'entreprise Oertli



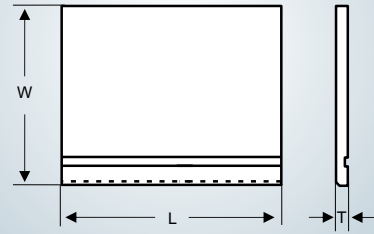

\* Da usare solo su teste portacottelli della Oertli

\* Sólo para empleo con portacuchillas de la firma Oertli

-  Knives with crossgroove and microfinish
-  Blanketts mit Quernut und Microfinish
-  Plaquettes avec rainure transversal et microfinish
-  Placchette con scanalatura e microfinish
-  Placas con ranura transversal y microfinish





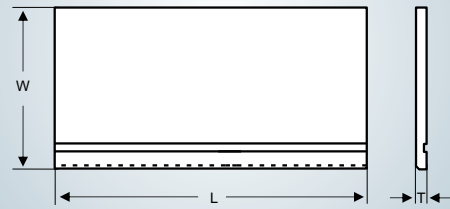

L mm	W mm	T mm	T04F	T08SMG	T10MG	TL15
20.5	16.5	2.0	037193	022937	038523	041097
20.5	22.5	2.0	037996	022941	022939	041098
20.5	25.5	2.0	041099	022944	022943	041100
20.5	27.9	2.0	041102	022947	022946	041101
20.5	30.6	2.0	041103	022950	022949	041104
20.5	34.0	2.0	041108	022953	041110	041109
25.5	25.5	2.0	041204	034517	041206	041205
25.5	27.9	2.0	041209	039427	041207	041208
25.5	30.6	2.0	041210	039425	041212	041211
25.5	34.0	2.0	041217	035621	041219	041218
30.5	22.5	2.0	036089	022958	022957	041111
30.5	25.5	2.0	041112	035435	022960	041113
30.5	27.9	2.0	041121	022963	022962	041118
30.5	30.6	2.0	041122	022966	022965	041123
30.5	34.0	2.0	041127	022969	041128	039072
35.5	22.5	2.0	041522	041523	041524	041525
35.5	25.5	2.0	041526	023023	041527	041528
35.5	32.5	2.0	041529	023025	041530	023024
40.25	16.5	2.0	040673	022971	041130	041129
40.25	22.5	2.0	041131	022974	022973	041132
40.25	25.5	2.0	041133	022977	022976	041134
40.25	27.9	2.0	041135	022981	022979	041136
40.25	30.6	2.0	041138	022984	022983	041137
40.25	32.6	2.0	041139	022987	022986	041140
40.25	34.0	2.0	039717	041143	041142	041141
50.25	22.5	2.0	039716	022991	022990	041144
50.25	25.5	2.0	041145	022994	022993	041146
50.25	27.9	2.0	040864	022997	022996	041147
50.25	30.6	2.0	041149	023000	022999	041148
50.25	32.6	2.0	041150	023003	023002	041151
50.25	34.0	2.0	041152	023004	041153	041154
60.25	22.5	2.0	041158	023008	023007	040666
60.25	25.5	2.0	037638	041159	023010	041160
60.25	27.9	2.0	036846	023013	023012	041161
60.25	30.6	2.0	041162	041164	023015	041163
60.25	32.6	2.0	041166	041165	023017	041167
80.25	16.5	2.0	041172	023022	041173	041174

-  Strips with crossgroove and microfinish
-  Leisten mit Quernut und Microfinish
-  Plaquettes avec rainure transversal et microfinish
-  Placchette con scanalatura e microfinish
-  Placas con ranura transversal y microfinish



L	W	T	T04F	T08SMG	T10MG	TL15
mm	mm	mm				
165.0	16.5	2.0	032154	032153	041225	032155
165.0	22.5	2.0	032162	023100	041226	032156
165.0	25.5	2.0	032163	023102	041227	032157
165.0	27.9	2.0	032164	023104	041228	032158
165.0	30.6	2.0	032165	023106	041229	032159
165.0	32.6	2.0	032166	023108	041230	032160
165.0	34.0	2.0	032167	032152	041231	032161





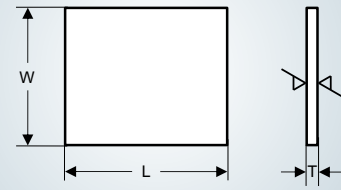

-  Blanks for profiling
-  Blanketts zum Profilieren
-  Plaquettes à profiler
-  Placchette da profilare
-  Placas para perfilar



Without bores  
Ohne Bohrung  
Sans trous  
Senza fori  
Sin taladros

 Thickness ground  Plangeschliffen  Rectifié  Rettificati sui piani  Rectificadas en el grosor

L mm	W mm	T mm	T04F	T03SMG	T10MG	TL15
30.0	15.0	2.0	018644	018643	018646	031856
40.0	15.0	2.0	018651	018650	018653	018654
40.0	20.0	2.0	018628	031857	018630	018631
40.0	25.0	2.0	018620	031858	018621	031859
40.0	30.0	2.0	018633	018632	031860	018635
40.0	35.0	2.0	018623	018622	018624	031861
48.0	15.0	2.0	018655	031863	018656	031862
48.0	20.0	2.0	018636	031864	018638	018639
48.0	25.0	2.0	018640	018641	018642	031865
50.0	45.0	2.0	018659	018660	018661	031866
50.0	25.4	1.5	018343	031867	031868	031869
60.0	20.0	2.0	018626	031870	031871	031872
60.0	40.0	2.0	018664	018663	018665	031875
80.0	35.0	2.0	018658	031876	031877	031878

-  Blanks for profiling
-  Blanketts zum Profilieren
-  Plaquettes à profiler
-  Placchette da profilare
-  Placas para perfilar

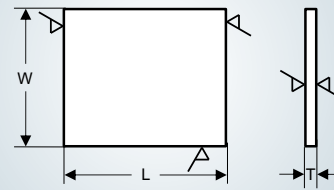

Without bores  
Ohne Bohrung  
Sans trous  
Senza fori  
Sin taladros

 3 sides ground  3 Seiten geschliffen  Rectifié à 3 côtés  Rettificati 3 lati  Rectificadas en 3 lados

L mm	W mm	T mm	T04F	T08CR	T10MG
15.0	15.7	2.0	107714	107755	107795
15.0	20.7	2.0	107715	107756	107796
20.0	20.7	2.0	107717	107757	107797
20.0	25.7	2.0	107718	107758	107798
20.0	30.7	2.0	107719	107759	107799
20.0	35.7	2.0	107720	107760	107800
25.0	20.7	2.0	107721	107761	107801
25.0	25.7	2.0	107722	107762	107802
25.0	30.7	2.0	107723	107763	107803
25.0	35.7	2.0	107724	107764	107804
30.0	20.7	2.0	107725	107765	107805
30.0	25.7	2.0	107726	107766	107806
30.0	30.7	2.0	107727	107767	107807
30.0	35.7	2.0	107728	107768	107808
30.0	40.7	2.0	107729	107769	107809
35.0	20.7	2.0	107730	107770	107810
35.0	25.7	2.0	107731	107771	107811
35.0	30.7	2.0	107732	107772	107812
35.0	35.7	2.0	107733	107773	107813
35.0	40.7	2.0	107734	107774	107814
40.0	20.7	2.0	107735	107775	107815
40.0	25.7	2.0	107736	107776	107816
40.0	30.7	2.0	107737	107777	107817
40.0	35.7	2.0	107738	107778	107818
40.0	40.7	2.0	107739	107779	107819
45.0	30.7	2.0	107740	107780	107820
45.0	35.7	2.0	107741	107781	107821
50.0	20.7	2.0	107742	107782	107822
50.0	25.7	2.0	107743	107783	107823
50.0	30.7	2.0	107744	107784	107824
50.0	35.7	2.0	107745	107785	107826
50.0	40.7	2.0	107746	107786	107827
60.0	20.7	2.0	107747	107787	107828
60.0	25.7	2.0	107748	107788	107829
60.0	30.7	2.0	107749	107789	107830
60.0	40.7	2.0	107750	107790	107831
60.0	45.7	2.0	107751	107791	107832
80.0	25.7	2.0	107752	107792	107833
80.0	35.7	2.0	107753	107793	107835
80.0	45.7	2.0	107754	107794	107836

 Backing plates

 Stützplatten

 Supports

 Supporti

 Placas de soporte

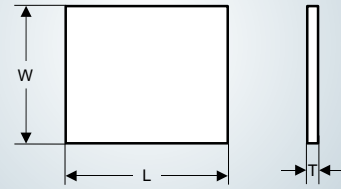

	L	W	T	L	W	T	Prod.-No.
	mm	mm	mm	for Blanks			
	38.0	27.0	4.0	40.0	30.0	2.0	015520
	48.0	45.0	4.0	50.0	45.0	2.0	015932
	58.0	32.0	4.0	60.0	35.0	2.0	016100
	58.0	38.0	4.0	60.0	40.0	2.0	016162

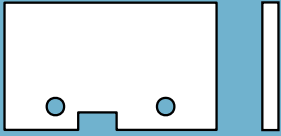
	L	W	T	L	W	T	Prod.-No.
	mm	mm	mm	for Superprofiler			
	40.0	26.0	4.0	41.0	28.0	1.5	015705
	50.0	33.0	4.0	51.0	35.0	1.5	015974
	60.0	28.0	4.0	61.0	31.0	1.5	016212
	60.0	45.0	6.0	61.0	45.0	2.0	016237
	80.0	43.0	6.0	81.0	45.0	2.0	016335

 Packing boxes

 Verpackungsschachteln

 Caisses d'emballage

 Contenitori per imballo

 Cajas de embalaje

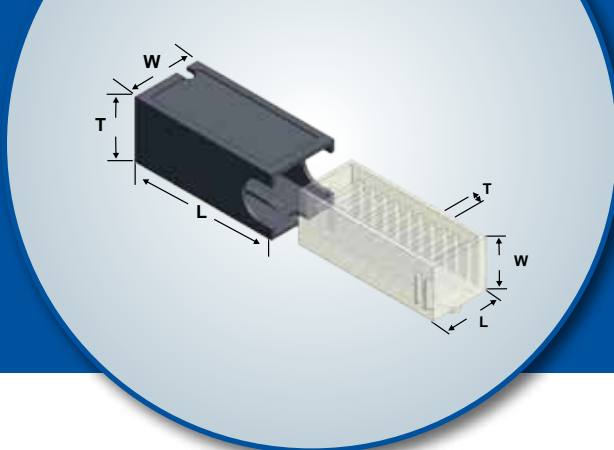

 in anthracite  in anthrazit  en anthracite  in antracite  en Antracita	External dimension box Außenmaß Schachtel Dimension externe de boîte Dimensione esterna Dimensión externa				Maximum knife dimension Maximales Messermaß Dimension maximum de couteau Dimensione massima della lama Dimensión máxima del cuchillo			Pieces Stück Unités Unità Unidades
	L mm	W mm	T mm	Art.	L mm	W mm	T mm	
	69	31.8	29.2	106393	23	23	4	10
	69	41.8	39.2	114845	33	33	4	10
	69	46.8	44.2	106404	38	38	4	10
	69	54.8	52.2	106856	46	46	4	10
	69	61.8	49.2	114844	53	43	4	10
	69	73.6	49.2	114843	65	43	4	10
	69	73.6	71.2	106858	65	65	4	10

 Preprofiled blanks







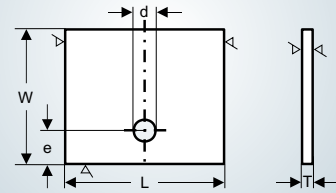

 Vorprofilerte Blanketts

 Plaquettes préprofilées

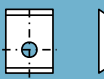
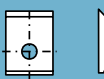
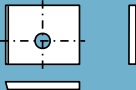
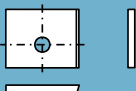
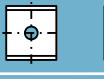

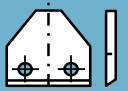

 Placchette presagomate

 Cuchillas preperfiladas



	L mm	W mm	T mm	d mm	e mm	R mm	T04F	T03SMG	T10MG
	13.0	16.0	2.0	3.0		2-4	015176	033175	033176
	13.0	16.0	2.0	4.0		2-4	015177	033178	033179
	20.0	21.0	2.0	3.0		5-8	015180	033181	033182
	20.0	21.0	2.0	4.0		5-8	015181	033184	033185
	26.0	24.0	2.0	3.0		9-13	015183	033187	033188
	26.0	24.0	2.0	4.0		9-13	015185	033190	033191
	12.0	14.5	2.0	4.0	6.0		017731	034072	034073
	12.0	18.0	2.0	4.0	6.0		019815	034075	034076
	12.0	18.0	2.0	5.0	5.5		037116	040950	040952
	19.6	15.5	2.0	4.0	6.0		035156	040942	040947
	19.6	15.5	2.0	4.0	6.0		035157	040943	040945
	13.0	14.0	1.5	3.2		2-4	015189	033193	033194
	20.0	16.0	2.0	3.2		5-8	015191	033203	033204
	26.0	18.0	2.0	3.2		9-13	015193	033206	033207
	30.0	20.0	2.0	3.2		14-16	015195	033213	033214
	16.0	17.5	2.0	3.0	5.0	2-6	017550	034059	034060
	16.0	17.5	2.0	3.5	5.0	2-6	015235	033227	033228
	16.0	17.5	2.0	4.0	5.0	2-6	015242	033233	033234
	16.0	17.5	2.0	4.4	5.0	2-6	051310	051311	051341
	20.0	17.5	2.0	4.0	6.0	2-8	015239	033236	033237
	20.0	20.5	2.0	4.0	6.3	2-6	015245	033239	033240
	16.0	17.5	2.0	4.4	5.4	2-6	015243	033230	033231
	24.0	20.4	2.0	4.2	6.3	2-6	015247		
	15.0	15.0	2.0	4.0	6.0		022306	034081	034082
	16.0	14.6	2.0	5.0	6.0		046698		



-  Profiled standard blanks
-  Profilierte Standardblanketts
-  Plaquettes standard profilées
-  Placchette profilate standard
-  Cuchillas perfiladas standard

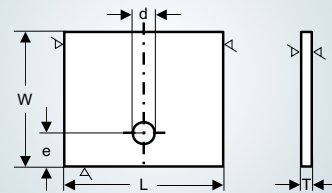

For Leuco system and  
Howema system\*

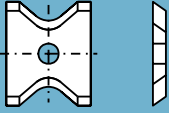
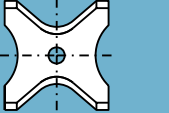
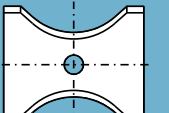
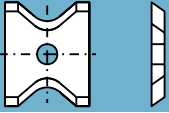
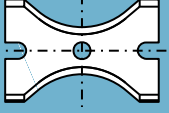
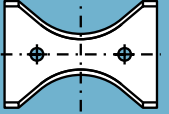
For Leuco system*	L mm	W mm	T mm	d mm	R mm	T04F	T03SMG	T10MG
	13.0	16.0	2.0	4.0	2.0	032836	032876	032904
	13.0	16.0	2.0	4.0	3.0	032837	032877	032909
	13.0	16.0	2.0	4.0	4.0	032838	032878	032908
	20.0	21.0	2.0	4.0	5.0	032839	113392	113397
	20.0	21.0	2.0	4.0	6.0	032840	113393	113398
	20.0	21.0	2.0	4.0	7.0	032841	113394	113399
	20.0	21.0	2.0	4.0	8.0	032842	113395	032915
	26.0	24.0	2.0	4.0	9.0	032843	032882	032919
	26.0	24.0	2.0	4.0	10.0	032844	032883	032920
	26.0	24.0	2.0	4.0	11.0	032845	052559	032921
	26.0	24.0	2.0	4.0	12.0	032846	032885	032922
	26.0	24.0	2.0	4.0	13.0	032847	032886	110692
		30.0	25.0	2.0	4.0	14.0	032848	033782
30.0		25.0	2.0	4.0	15.0	032849	033785	033786
30.0		25.0	2.0	4.0	16.0	032850	033788	033789
For Howema system*	L mm	W mm	T mm	d mm	R mm	T04F	T03SMG	T10MG
	13.0	14.0	1.5	3.2	2.0	016376	033809	033810
	13.0	14.0	1.5	3.2	3.0	016377	033812	033813
	13.0	14.0	1.5	3.2	4.0	016378	033815	033816
	20.0	16.0	2.0	3.2	5.0	016379	033818	033819
	20.0	16.0	2.0	3.2	6.0	016380	033821	033822
	20.0	16.0	2.0	3.2	7.0	016381	033824	033825
	20.0	16.0	2.0	3.2	8.0	016382	033827	033828
	26.0	18.0	2.0	3.2	9.0	016383	033830	033831
	26.0	18.0	2.0	3.2	10.0	016384	033833	033834
	26.0	18.0	2.0	3.2	11.0	016385	033836	033837
	26.0	18.0	2.0	3.2	12.0	016386	033839	033840
	26.0	18.0	2.0	3.2	12.5	016391	033867	033868
	30.0	20.0	2.0	3.2	13.0	016387	033842	033843
	30.0	20.0	2.0	3.2	14.0	016388	033845	033846
	30.0	20.0	2.0	3.2	15.0	016389	033848	033849
	30.0	20.0	2.0	3.2	16.0	016390	033851	033852
	40.0	28.0	2.0	3.2	17.0	016371	033854	033855
	40.0	28.0	2.0	3.2	18.0	016372	033857	033858
	40.0	28.0	2.0	3.2	19.0	016373	033860	033861
	40.0	28.0	2.0	3.2	20.0	016374	033863	033864

\* For use in Leuco/Howema-cutterheads only  
 \* Nur zur Verwendung in Messerköpfen der Firma Leuco bzw. Howema  
 \* Utilisation limitée aux porte outils de l'entreprises Leuco et Howema  
 \* Da usare solo su teste portacoltelli della Leuco - Howema  
 \* Sólo para empleo con portacuchillas de la firma Leuco/Howema

 Profiled standard blanks







 Profilierte Standardblanketts

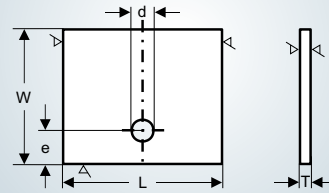

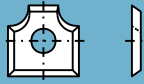

 Plaquettes standard profilées

 Placchette profilate standard

 Cuchillas perfiladas standard



	L mm	W mm	T mm	d mm	R mm	T04F	T03SMG	T10MG
	12.0	12.0	1.5	4.0	2.0	016426	033022	033024
	12.0	12.0	1.5	4.0	3.0	016427	033021	033025
	12.0	12.0	1.5	4.0	4.0	016428	033023	033026
	12.0	13.0	2.0	4.0	2.0	020990	033877	033878
	12.0	13.0	2.0	4.0	2.5	022185	033874	033875
	12.0	13.0	2.0	4.0	3.0	020853	033871	033872
	16.0	14.0	2.0	4.0	3.0	039045		
	16.0	17.5	2.0	3.0	2.0	016515	033880	033881
	16.0	17.5	2.0	3.0	3.0	016516	033883	033884
	16.0	17.5	2.0	3.0	4.0	016518	033886	033887
	16.0	17.5	2.0	3.0	5.0	016519	033889	033890
	16.0	17.5	2.0	3.5	2.0	016469	033892	033893
	16.0	17.5	2.0	3.5	3.0	016470	033895	033896
	16.0	17.5	2.0	3.5	4.0	016472	033898	033899
	16.0	17.5	2.0	3.5	5.0	016473	033901	033902
	16.0	17.5	2.0	3.5	6.0	016474	033904	033905
	16.0	17.5	2.0	4.0	2.0	016477	032968	032973
	16.0	17.5	2.0	4.0	3.0	016478	032969	032974
	16.0	17.5	2.0	4.0	4.0	016479	032970	032975
	16.0	17.5	2.0	4.0	5.0	016480	032971	032976
	16.0	17.5	2.0	4.4	2.0	016510	033907	033908
	16.0	17.5	2.0	4.4	3.0	016511	033910	033911
	16.0	17.5	2.0	4.4	4.0	016512	033913	033914
16.0	17.5	2.0	4.4	5.0	016513	033916	033917	
	24.0	20.0	2.0	4.4	6.0	033919	033924	033925
	24.0	20.0	2.0	4.4	7.0	033920	033927	033928
	24.0	20.0	2.0	4.4	8.0	033921	033930	033931
	24.0	20.0	2.0	4.4	9.0	033922	033933	033934
	24.0	20.0	2.0	4.4	10.0	033923	033936	033937
	20.0	20.5	2.0	4.0	2.0	016495	032991	032996
	20.0	20.5	2.0	4.0	3.0	016496	032992	032997
	20.0	20.5	2.0	4.0	4.0	016497	032993	032998
	20.0	20.5	2.0	4.0	5.0	016498	032994	032999
	20.0	20.5	2.0	4.0	6.0	016499	032995	033000
	20.0	20.5	2.0	4.0	2.0	016500	033007	033011
	20.0	20.5	2.0	4.0	3.0	016501	033006	033012
	20.0	20.5	2.0	4.0	4.0	016502	033008	033013
	20.0	20.5	2.0	4.0	5.0	016503	033009	033014
	20.0	20.5	2.0	4.0	6.0	016504	033010	033015

-  Profiled standard blanks
-  Profilierte Standardblanketts
-  Plaquettes standard profilées
-  Placchette profilate standard
-  Cuchillas perfiladas standard

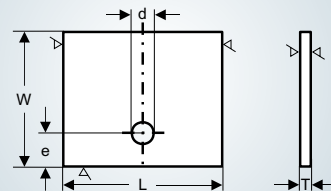

	L mm	W mm	T mm	d mm	R mm	T04F	T03SMG	T10MG
	15.0	14.5	2.0	4.0	2.0	022305	033941	033942
	15.0	14.5	2.0	4.0	2.5	033939	033947	033948
	15.0	14.5	2.0	4.0	3.0	022308	033953	033954
	16.1	14.0	2.0	5.0	2.0	046693		
	16.1	14.0	2.0	5.0	3.0	049986		
	15.0	14.5	2.0	4.0	2.0	022307	033944	033945
	15.0	14.5	2.0	4.0	2.5	033940	033950	033951
	15.0	14.5	2.0	4.0	3.0	022309	033956	033957
	16.1	14.0	2.0	5.0	2.0	046694		
	16.1	14.0	2.0	5.0	3.0	049987		
	12.0	14.5	2.0	4.0	2.0	021044	033973	033974
	12.0	14.5	2.0	4.0	2.5	020397	034109	034110
	12.0	14.5	2.0	4.0	3.0	020620	034100	034101
	19.6	15.2	2.0	4.0	2.0	033963	033997	033998
	19.6	15.2	2.0	4.0	3.0	033967	034003	034004
	12.0	14.5	2.0	4.0	2.0	021045	033981	033982
	12.0	14.5	2.0	4.0	2.5	020396	034106	034107
	12.0	14.5	2.0	4.0	3.0	020619	034103	034104
	19.6	15.2	2.0	4.0	2.0	033966	034000	034001
	19.6	15.2	2.0	4.0	3.0	033968	034006	034007
	12.0	18.0	2.0	4.0	2.0	033969	034009	034010
	12.0	18.0	2.0	4.0	3.0	033970	034015	034017
IMA	12.0	18.0	2.0	4.0	2.0	034024	034037	034038
	12.0	18.0	2.0	4.0	3.0	034031	034040	034041
	12.0	18.0	2.0	4.0	2.0	033971	034012	034013
	12.0	18.0	2.0	4.0	3.0	033972	034019	034020
IMA	12.0	18.0	2.0	4.0	2.0	034025	041378	041379
	12.0	18.0	2.0	4.0	3.0	034032	040440	041381

 Profiled standard blanks





 Profilierte Standardblanketts



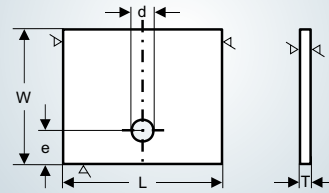

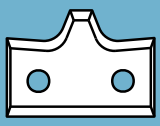
 Plaquettes standard profilées

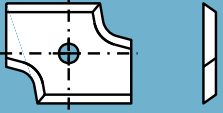
 Placchette profilate standard

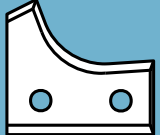
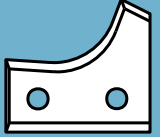





 Cuchillas perfiladas standard

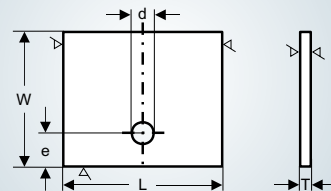

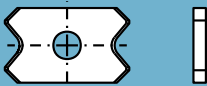
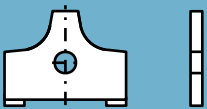

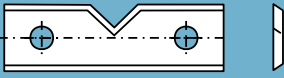

	L	W	T	d	a	R	T04F	T03SMG	T10MG
	mm	mm	mm	mm	mm	mm			
	20.8	15.0	2.0	4.0	12.0	2.0	016429	033565	033566
	20.8	15.0	2.0	4.0	12.0	3.0	016430	033568	033569
	20.8	15.0	2.0	4.0	12.0	4.0	016431	033571	033572
	30.0	17.0	2.0	4.0	20.0	5.0	016432	033574	033575
	30.0	17.0	2.0	4.0	20.0	6.0	016433	033577	033578
	30.0	17.0	2.0	4.0	20.0	7.0	016434	033580	033581
	30.0	17.0	2.0	4.0	20.0	8.0	016435	033583	033584
	30.5	16.5	2.0	3.2	20.0	5.0	016452	033595	033596
	30.5	16.5	2.0	3.2	20.0	6.0	016453	033598	033599
	30.5	16.5	2.0	3.2	20.0	7.0	016454	033601	033602
30.5	16.5	2.0	3.2	20.0	8.0	016455	033604	033605	
	20.0	16.0	2.0	3.0		3.0	033311	033607	033608
	30.0	14.0	2.0	4.0		2.0	033312	033610	033611
	30.0	14.0	2.0	4.0		2.5	033313	033613	033614
	30.0	14.0	2.0	4.0		3.0	033314	033616	033617
	20.0	16.0	2.0	3.0		3.0	033315	033619	033620
	30.0	14.0	2.0	4.0		2.0	033316	033622	033623
	30.0	14.0	2.0	4.0		2.5	033317	033625	033626
	30.0	14.0	2.0	4.0		3.0	033318	033628	033629
	12.0	12.0	1.5	4.0		45°	033319	033632	033633
	16.0	17.5	2.0	4.0		45°	032964	032965	032966
	16.0	17.5	2.0	4.4		45°	033324	041057	041058
	16.0	17.5	2.0	3.5		45°	015237	034112	034113
	21.8	19.5	2.0	3.0	12.0	10.0	033670	033674	033675
	21.8	19.5	2.0	3.0	12.0	12.0	033671	033677	033678
	21.5	20.0	2.0	3.0	12.0	9.0	016445	033657	033658
	21.5	20.0	2.0	3.0	12.0	10.0	016446	033660	033661
	21.5	20.0	2.0	3.0	12.0	11.0	016447	033663	033664
	21.5	20.0	2.0	3.0	12.0	12.0	016448	033666	033667
	21.8	19.5	2.0	3.0	12.0	10.0	033672	033680	033681
	21.8	19.5	2.0	3.0	12.0	12.0	033673	033685	033686
	21.5	20.0	2.0	3.0	12.0	9.0	016436	033645	033646
	21.5	20.0	2.0	3.0	12.0	10.0	016437	033648	033649
	21.5	20.0	2.0	3.0	12.0	11.0	016438	033651	033652
	21.5	20.0	2.0	3.0	12.0	12.0	016439	033654	033655

-  Profiled standard blanks
-  Profilierte Standardblanketts
-  Plaquettes standard profilées
-  Placchette profilate standard
-  Cuchillas perfiladas standard





	L mm	W mm	T mm	d mm	R mm	A°	T04F	T03SMG	T06MF
	20.0	12.0	2.0	4.0	1.0	6°	032984	033031	
	20.0	12.0	2.0	4.0	1.0	15°	050309	050310	
	20.0	12.0	2.0	4.0	2.0	6°	016419	033033	
	20.0	12.0	2.0	4.0	2.0	15°	050311	050312	
	20.0	12.0	2.0	4.0	3.0	6°	016420	033034	
	20.0	12.0	2.0	4.0	3.0	15°	050313	050314	
	20.0	12.0	2.0	4.0	4.0	6°	016421	033043	
	20.0	12.0	2.0	4.0	5.0	6°	016422	033042	
	20.0	11.5	2.0	4.5	1.5		050088		
	20.0	11.5	2.0	4.5	2.0		050089		
	20.0	11.5	2.0	4.5	2.5		050090		
	20.0	11.5	2.0	4.5	3.0		050091		
	12.7	12.7	3.2		2.0				035041
	12.7	12.7	3.2		3.0				037922
	15.5	15.2	1.5	4.6	3.0		021377		
	19.5	9.0	1.5	4.0	5x45°		033086	033118	
	19.5	12.0	1.5	4.0	5x45°		034228	034229	
	19.5	9.0	1.5	4.0	5.0		033090	033128	
	19.5	12.0	1.5	4.0	5.0		034232	034233	
	19.5	9.0	1.5	4.0	2.0		033117	033142	
	19.5	9.0	1.5	4.0	3.0		033097	033146	
	19.5	9.0	1.5	4.0	4.0		033098	033149	
	19.5	9.0	1.5	4.0	5.0		033099	033152	
	19.5	12.0	1.5	4.0	2.0		034236	034240	
	19.5	12.0	1.5	4.0	3.0		034237	034243	
	19.5	12.0	1.5	4.0	4.0		034238	034246	
	19.5	12.0	1.5	4.0	5.0		034239	034249	
		39.5	12.0	1.5	4.0			033400	033401

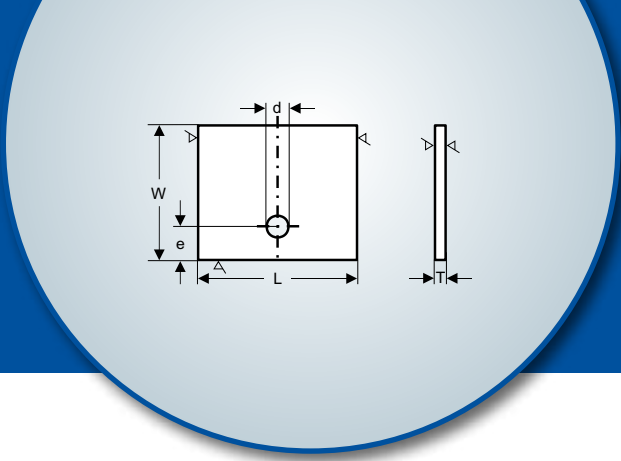

-  Profiled standard blanks
-  Profilierte Standardblanketts
-  Plaquettes standard profilées
-  Placchette profilate standard
-  Cuchillas perfiladas standard

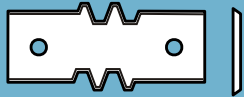
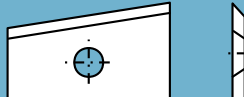
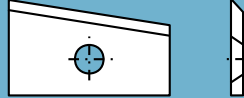

	L mm	W mm	T mm	d mm	a mm	R mm	T04F
	50.0	21.6	2.0	4.1	26.0		035810
	30.0	22.5	3.0				020272
	55.0	25.0	3.0				020502
	30.0	22.5	3.0				020273
	55.0	25.0	3.0				020503

Oertli System*	L mm	W mm	T mm	Type	T04F	T10MG
	20.0	13.5	2.0	TW32-R2	033429	033430
	20.0	13.5	2.0	TW32-R3	033427	033428
	20.0	13.5	2.0	TW32-R4	033431	033432
	20.0	13.5	2.0	TW32-R5	033433	033434
	20.0	13.5	2.0	TW32-R6	033435	033436
	29.0	16.5	2.5	TW32-R7	033437	033438
	29.0	16.5	2.5	TW32-R8	033439	033440
	29.0	16.5	2.5	TW32-R9	033441	033442
	29.0	16.5	2.5	TW32-R10	033443	033444
	40.0	21.0	2.5	TW32-R11	033445	033446
	40.0	21.0	2.5	TW32-R11.5	033447	033448
	40.0	21.0	2.5	TW32-R12	033449	033450
	40.0	21.0	2.5	TW32-R13	033451	033452
	40.0	21.0	2.5	TW32-R14	033453	033454
	40.0	21.0	2.5	TW32-R15	033455	033456





\* For use in Oertli-cutterheads only

\* Nur zur Verwendung in Messerköpfen der Firma Oertli

\* Utilisation limitée aux porte outils de l'entreprise Oertli

\* Da usare solo su teste portacoltelli della Oertli

\* Sólo para empleo con portacuchillas de la firma Oertli

-  TIGRAlloy - Blanks for profiling
-  TIGRAlloy - Blanketts zum Profilieren
-  TIGRAlloy - Plaquettes à profiler
-  TIGRAlloy - Placchette da profilare
-  TIGRAlloy - Placas para perfilar

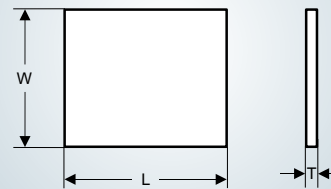

 TIGRAlloy, a cutting material, consisting of a mixture of hard chromium and tungsten carbide that are embedded in a tough cobalt matrix. This results in an ideal combination of high hardness and high toughness. Therefore TIGRAlloy is an ideal cutting material for many kinds of solid wood. In addition to the good wear resistance, there is a high heat resistance. Very good brazeability affords the opportunity to grind extremely sharp cutting edges.

**Characteristics:**

Hardness: 60 HRC - Heat resistance: up to 800°C / 1500°F - Highly corrosion resistant - Extremely shock proof

 TIGRAlloy besteht aus harten Chrom- und Wolframkarbiden, die in einer zähen Kobaltmatrix eingelagert sind. Daraus entsteht eine ideale Kombination von hoher Härte und besonders guter Zähigkeit. TIGRAlloy ist damit ein idealer Schneidstoff für die Bearbeitung vieler Massivhölzer. Zu einer hohen Verschleißfestigkeit kommt eine hohe Hitzebeständigkeit, eine sehr gute Lötbarkeit und die Möglichkeit, mit sehr scharfen Schneidkanten zu arbeiten.

**Eigenschaften:**

Härte: 60 HRC - Hitzebeständigkeit: bis 800°C - Sehr korrosionsbeständig - Hohe Bruchfestigkeit

 TIGRAlloy est constitué de carbures de chrome et de tungstène durs qui sont logés dans une matrice de cobalt résistante. TIGRAlloy est ainsi un matériau de coupe idéal pour l'usinage de nombreux bois massifs. Outre une grande résistance à l'usure, il présente également une forte résistance à l'échauffement, une excellente brasabilité et la possibilité de travailler avec des arêtes de coupe très vives.

**Propriétés:**

Dureté: 60 HRC - Resistance à la chaleur: jusqu'à 800°C - Très résistant à la corrosion - Grande résistance à la rupture

 TIGRAlloy è composta da carburo duro di cromo e tungsteno, incastonati in una matrice di cobalto tenace. Una combinazione ideale di durezza e di resistenza. TIGRAlloy è oltretutto materiale ideale al taglio di molti tipi particolari di legno. La buona resistenza all'usura nonché la grande resistenza termica e alla saldobrasatura permettono l'uso di taglienti molto affilati.





**Caratteristiche:**

Durezza: 60 HRC - Resistenza termica: fino a 800°C - Alta resistenza alla corrosione - Alta resistenza alla flessione

 TIGRAlloy se compone de carburos duros de cromo y volframio que están depositados en una matriz de cobalto resistente. Así se consigue una combinación ideal de alta dureza y de resistencia especialmente buena. Por lo tanto, TIGRAlloy es un material de corte ideal para el labrado de muchas maderas macizas. A esa alta resistencia de desgaste se añade una alta resistencia refractaria, una buena soldadura y la posibilidad de trabajar con aristas cortantes muy vivas.



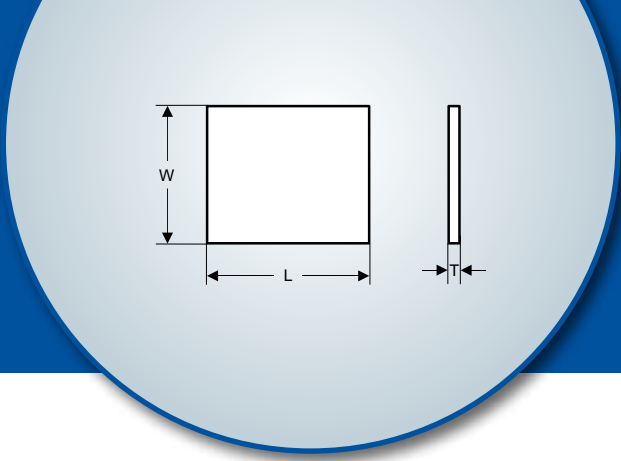

**Propiedades:**

Dureza: 60 HRC - Resistencia a calor hasta 800°C - Alta resistencia a la corrosión - Alte resistencia a la rotura

-  TIGRAIloy - Blanks for profiling
-  TIGRAIloy - Blanketts zum Profilieren
-  TIGRAIloy - Plaquettes à profiler
-  TIGRAIloy - Placchette da profilare
-  TIGRAIloy - Placas para perfilar





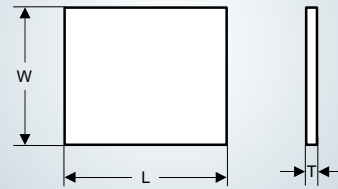

	L	W	T	d	a	e	TIGRAIloy
	mm	mm	mm	mm	mm	mm	
	15.0	20.4	2.0	4.1		6.3	050254
	15.0	25.4	2.0	4.1		6.3	062363
	15.0	30.4	2.0	4.1		6.3	050432
	20.0	20.4	2.0	4.1		6.3	050433
	20.0	25.4	2.0	4.1		6.3	050434
	20.0	30.4	2.0	4.1		6.3	050435
	25.0	20.4	2.0	4.1		6.3	061898
	25.0	25.4	2.0	4.1		6.3	050437
	25.0	30.4	2.0	4.1		6.3	050438
	30.0	25.4	2.0	4.1		6.3	062030
	30.0	30.4	2.0	4.1		6.3	061982
	30.0	35.4	2.0	4.1		6.3	062039
	35.0	30.4	2.0	4.1		6.3	061960
	35.0	35.4	2.0	4.1		6.3	050443
	20.0	20.4	2.0	4.5		6.5	050255
	20.0	25.4	2.0	4.5		6.5	050444
	20.0	30.4	2.0	4.5		6.5	062217
	25.0	25.4	2.0	4.5		6.5	050446
	25.0	30.4	2.0	4.5		6.5	050447
	30.0	30.4	2.0	4.5		6.5	050448

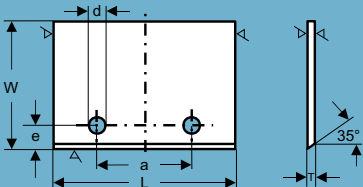
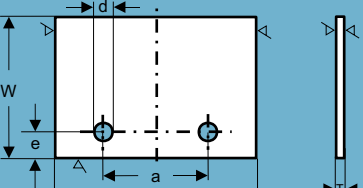
-  TIGRAlloy - Blanks for profiling
-  TIGRAlloy - Blanketts zum Profilieren
-  TIGRAlloy - Plaquettes à profiler
-  TIGRAlloy - Placchette da profilare
-  TIGRAlloy - Placas para perfilar



	L	W	T	d	a	e	TIGRAlloy	
	mm	mm	mm	mm	mm	mm		
	30.0	25.4	2.0	4.1	14.0	6.3	050256	
	30.0	30.4	2.0	4.1	14.0	6.3	062258	
	30.0	35.4	2.0	4.1	14.0	6.3	062101	
	40.0	25.4	2.0	4.1	26.0	5.5	062124	
	40.0	30.4	2.0	4.1	20.0	5.5	046483	
	40.0	35.4	2.0	4.1	26.0	5.5	046485	
	40.0	35.4	2.0	4.1	26.0	6.0	062075	
	40.0	35.4	2.0	4.1	26.0	6.3	050453	
	40.0	40.4	2.0	4.1	26.0	6.0	062117	
	40.0	45.4	2.0	4.1	26.0	6.0	062083	
	50.0	16.0	2.0	4.1	26.0	5.5	050456	
	50.0	20.0	2.0	4.1	26.0	5.5	050457	
	50.0	25.4	2.0	4.1	26.0	5.5	062064	
	60.0	25.4	2.0	4.1	26.0	5.5	050459	
	60.0	35.4	2.0	4.1	44.0	6.0	062289	
	60.0	40.0	2.0	4.1	44.0	6.0	046487	
		19.0	30.0	2.0	3.6	8.5	4.75	062277
		30.0	20.4	2.0	4.1	14.0	6.5	050257
30.0		25.4	2.0	4.1	19.0	4.75	062063	
30.0		25.4	2.0	4.1	14.0	6.5	050464	
30.0		30.4	2.0	4.1	14.0	6.5	050465	
30.0		30.0	2.0	4.1	19.0	4.75	062278	
35.0		25.4	2.0	4.1	14.0	6.5	050467	
35.0		30.4	2.0	4.1	14.0	6.5	062274	
40.0		20.4	2.0	4.1	26.0	6.5	062105	
40.0		25.4	2.0	4.1	26.0	6.5	047452	
40.0		30.4	2.0	4.1	26.0	6.5	050470	
40.0		35.4	2.0	4.1	26.0	5.5	050471	
50.0		20.4	2.0	4.1	26.0	6.5	050472	
50.0		25.4	2.0	4.1	26.0	6.5	050473	
50.0		30.4	2.0	6.0	26.0	6.5	047593	
60.0		20.4	2.0	4.1	26.0	6.5	050474	
60.0		25.4	2.0	4.1	26.0	6.5	050475	
60.0		30.4	2.0	4.1	26.0	6.5	050476	

-  TIGRAIloy - Blanks for profiling
-  TIGRAIloy - Blanketts zum Profilieren
-  TIGRAIloy - Plaquettes à profiler
-  TIGRAIloy - Placchette da profilare
-  TIGRAIloy - Placas para perfilar

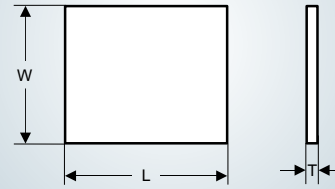

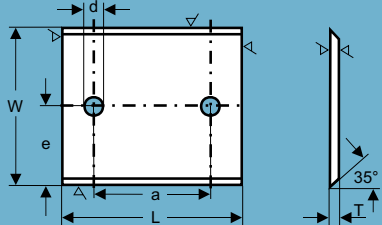
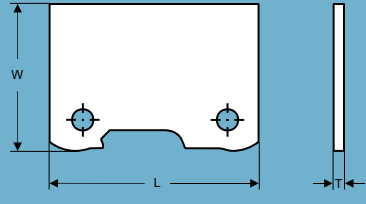



	L	W	T	d	a	e	TIGRAIloy	
	mm	mm	mm	mm	mm	mm		
	40.0	25.0	2.0	4.1	20.0		050258	
	40.0	30.0	2.0	3.5	20.0		050477	
	40.0	30.0	2.0	4.1	20.0		050478	
	40.0	35.0	2.0	4.1	26.0		047372	
	40.0	40.0	2.0	3.5	26.0		050479	
	45.0	35.0	2.0	4.1	26.0		046971	
	50.0	16.0	2.0	4.1	26.0		050480	
	50.0	25.0	2.0	4.1	26.0		050481	
	50.0	45.0	2.0	4.1	34.0		050482	
	60.0	35.0	2.0	4.1	26.0		046520	
	60.0	35.0	2.0	4.1	44.0		047030	
		41.0	28.0	1.5				047376
		61.0	31.0	1.5				047377
		61.0	45.0	2.0				047375

Other dimensions upon request.  
 Andere Abmessungen auf Anfrage.  
 D'autres dimensions sur demande.  
 Altri dimensioni a richiesta.  
 Otras dimensiones bajo demanda.







**Tools cut better  
with TIGRA**



-  **Saw tips and strobe blanks**
-  **Sägezähne und Wischerblätter**
-  **Dents de scie et racleurs**
-  **Dentelli per lame e barrette per rasanti**
-  **Dientes de sierra y rasuradores**















-  **Saw tips - TIGRA carbide grades and their applications – Technical Data**
-  **Sägezähne - TIGRA Hartmetallsorten und ihre Anwendungen – Technische Daten**
-  **Dents de scie - Les nuances de carbures TIGRA et leurs applications – Caractéristiques techniques**
-  **Dentelli per lame - I tipi di metallo duro TIGRA e le loro applicazioni – Dati tecnici**
-  **Dientes de sierra - Calidades de metal duro TIGRA y sus aplicaciones – Datos técnicos**

 TIGRA grade  TIGRA - Sorte  Nuance TIGRA  Tipo TIGRA  Calidad TIGRA	Binder Binder Liant Legante Composicion	Hardness Härte Dureté Durezza Durezza			Bending strength Biegebruchfestigkeit Resistance à la flexion Resistenza flessionale Resistencia a la flexión		Toughness Zähigkeit Ténacité Tenacità Tenacidad
		%	HV 10	HRA ±0.2	N/mm <sup>2</sup>	psi	
<b>T05CR*</b> ISO: K01 USA: C4 ++	3.0	2100	94.6	2500	363.000	6.9	
<b>T06CR*</b> ISO: K01 USA: C4 +	3.0	1950	94.0	2300	334.000	8.2	
<b>T04F</b> ISO: K05 USA: C4	4.0	1750	92.8	2350	341.000	8.6	
<b>T06F</b> ISO: K10 USA: C3	6.0	1740	92.7	2350	341.000	9.0	
<b>T06MF</b> ISO: K20 USA: C2	6.5	1600	92.0	2500	363.000	9.9	
<b>T08MF</b> ISO: K30 USA: C2	8.5	1470	90.9	2700	392.000	10.3	
<b>T10MG</b> ISO: K10-K40 USA: C3 +	10.0	1650	92.3	3600	522.000	9.4	
<b>T12M</b> ISO: >K40 USA: C1	12.0	1250	88.7	2800	406.000	14.0	
<b>T15C</b> ISO: >K40 USA: Nail Cut	15.0	890	84.5	3000	435.000	> 20	





\* Special binder - Spezialbinder - Liant special - Legante speciale - Composicion especial

 TIGRA grade  TIGRA - Sorte  Nuance TIGRA  Tipo TIGRA  Calidad TIGRA	HDF	MDF	Chipboard Spanplatte Panneaux de particule Truciolare Panel de aglomerado	Hardwood Hartholz Bois dur Legno duro Madera dura	Softwood Weichholz Bois tendre Legno tenero Madera blanda
<b>T05CR</b>	+++	+++	+	--	--
<b>T06CR</b>	++	+++	+++	-	--
<b>T04F</b>	0	+	++	++	+
<b>T06F</b>	-	0	+	++	++
<b>T06MF</b>	--	-	0	+	++
<b>T08MF</b>	---	--	-	+	++
<b>T10MG</b>	---	---	0	++	++
<b>T12M</b>	---	---	--	0	+++
<b>T15C</b>	---	---	---	0	+++





					
+++	Excellent	Hervorragend	Parfaitement	Ottimo	Perfectamente
++	Very Good	Sehr gut	Très bien	Molto idoneo	Muy
+	Good	Gut	Bien	Idoneo	Algo
0	Acceptable	Akzeptabel	Acceptable	Accettabile	Acceptable
-	Not too good	Weniger gut	Moins bien	Meno idoneo	Mal
--	Poor	Schlecht geeignet	Mal adapté	Poco idoneo	Nada apropiado
---	Not suitable	Nicht geeignet	Pas utilisable	Non utilizzabile	No utilizable

-  **Saw tips - TIGRA carbide grades and their applications**
-  **Sägezähne - TIGRA Hartmetallsorten und ihre Anwendungen**
-  **Dents de scie - Les nuances de carbures TIGRA et leurs applications**
-  **Dentelli per lame - I tipi di metallo duro TIGRA e le loro applicazioni**
-  **Dientes de sierra - Calidades de metal duro TIGRA y sus aplicaciones**

 TIGRA grade  TIGRA - Sorte  Nuance TIGRA  Tipo TIGRA  Calidad TIGRA	Main usage Hauptanwendung Principal usage Main uso Uso principal	
<b>T05CR</b>	HDF/MDF HDF/MDF HDF/MDF HDF/MDF HDF/MDF	
<b>T06CR</b>	HDF/MDF/chipboard HDF/MDF/Spanplatte HDF/MDF/panneaux HDF/MDF/truciolare HDF/MDF/aglomerado	
<b>T04F</b>	Harder universal grade Härtere Universalsorte nuance universelle dure HW universale duro Dureza grado standard	
<b>T06F</b>	Softer universal grade Weichere Universalsorte Nuance universelle tenace HW universale tenero Dureza grado tenaz	
<b>T06MF</b>	Saw mills, hobby saws, strobe tips Sägewerke, Hobbysägen, Wischerblätter Scieries, scies de bricolage, racleurs Segherie, lame hobbistiche, barrette rasanti Fresa-disco, barredores de raspado	
<b>T08MF</b>	Wood cutting, hobby saws, strobe tips Holz, Hobbiesägen, Wischerblätter Bois, scies de bricolage, racleurs Legno, lame hobbistiche, barrette rasanti Madera, disco, barredores de raspado	
<b>T10MG</b>	Wood Holz Bois Legno Madera	
<b>T12M</b>	Saw mills, frozen wood Sägewerke, gefrorenes Holz Scieries, bois congelé Segherie, legno congelato Fresa-disco, madera congelada	
<b>T15C</b>	Nail cutting, recycling Holz mit Nägeln, Recycling Couper des clous, recyclage Legno con chiodi, riciclato Viruta de madera reciclada	

-  Saw tips and strobe blanks
-  Sägezähne und Wischerblätter
-  Dents de scie et racleurs
-  Dentelli per lame e barrette per rasanti
-  Dientes de sierra y rasuradores

	<ul style="list-style-type: none"> <li> Carbide saw tips for circular saws (in mm)</li> <li> Hartmetallsägezähne für Kreissägen (in mm)</li> <li> Dents de scie pour scies circulaires (en mm)</li> <li> Dentelli per lame per rasanti di lame circolari (in mm)</li> <li> Dientes de sierra para sierras circulares (in mm)</li> </ul>	<div style="background-color: #c00000; color: white; border-radius: 10px; padding: 5px 15px; display: inline-block;">71-74</div>
	<ul style="list-style-type: none"> <li> Carbide saw tips for circular saws (in inch) „CW-Style“</li> <li> Hartmetallsägezähne für Kreissägen (in inch) „CW-Style“</li> <li> Dents de scie pour scies circulaires (en inch) „CW-Style“</li> <li> Dentelli per lame per rasanti di lame circolari (in inch) „CW-Style“</li> <li> Dientes de sierra para sierras circulares (in inch) „CW-Style“</li> </ul>	<div style="background-color: #c00000; color: white; border-radius: 10px; padding: 5px 15px; display: inline-block;">75-80</div>
	<ul style="list-style-type: none"> <li> Carbide saw tips for circular saws (in inch) „W-Style“</li> <li> Hartmetallsägezähne für Kreissägen (in inch) „W-Style“</li> <li> Dents de scie pour scies circulaires (en inch) „W-Style“</li> <li> Dentelli per lame per rasanti di lame circolari (in inch) „W-Style“</li> <li> Dientes de sierra para sierras circulares (in inch) „W-Style“</li> </ul>	<div style="background-color: #c00000; color: white; border-radius: 10px; padding: 5px 15px; display: inline-block;">81-84</div>
	<ul style="list-style-type: none"> <li> Strobe blanks for circular saws (in mm)</li> <li> Wischerblätter für Kreissägen (in mm)</li> <li> Racleurs pour scies circulaires (en mm)</li> <li> Barrette per rasanti di lame circolari (in mm)</li> <li> Rasuradores para sierras circulares (in mm)</li> </ul>	<div style="background-color: #c00000; color: white; border-radius: 10px; padding: 5px 15px; display: inline-block;">85</div>
	<ul style="list-style-type: none"> <li> Strobe blanks for circular saws (in inch)</li> <li> Wischerblätter für Kreissägen (in inch)</li> <li> Racleurs pour scies circulaires (en inch)</li> <li> Barrette per rasanti di lame circolari (in inch)</li> <li> Rasuradores para sierras circulares (in inch)</li> </ul>	<div style="background-color: #c00000; color: white; border-radius: 10px; padding: 5px 15px; display: inline-block;">86</div>
	<ul style="list-style-type: none"> <li> Pretinned saw tips (in mm)</li> <li> Lotbeschichtete Sägezähne (in mm)</li> <li> Dents de scie pre-brasées (en mm)</li> <li> Dentelli saldo-brasati per lame (in mm)</li> <li> Dientes de sierra con solda (in mm)</li> </ul>	<div style="background-color: #c00000; color: white; border-radius: 10px; padding: 5px 15px; display: inline-block;">87-88</div>
	<ul style="list-style-type: none"> <li> Brazing alloys and fluxes</li> <li> Lot und Flussmittel</li> <li> Alliages et flux de brasage</li> <li> Leghe brasanti e disossidanti</li> <li> Aleaciones y fundentes para soldadura fuerte</li> </ul>	<div style="background-color: #c00000; color: white; border-radius: 10px; padding: 5px 15px; display: inline-block;">89-90</div>

-  Carbide saw tips for circular saws
-  Hartmetallsägezähne für Kreissägen
-  Dents de scie pour scies circulaires
-  Dentelli per lame per rasanti di lame circolari
-  Dientes de sierra para sierras circulares

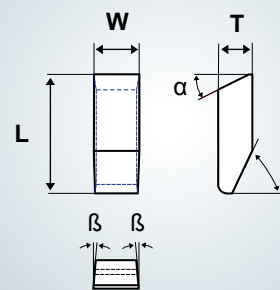





in mm

L mm	W mm	T mm	$\alpha$	$\beta$	$\gamma$	T06CR	T06F
6.5	2.0	2.0	27	5	56	111681	111686
6.5	2.5	2.0	27	5	56	111682	111687
6.5	3.0	2.0	27	5	56	111683	111688
6.5	3.5	2.0	27	5	56	111684	111689
6.5	3.8	2.0	27	5	56	111685	111690

L mm	W mm	T mm	$\alpha$	$\beta$	$\gamma$	T05CR	T06CR	T04F	T06F
8.0	2.2	2.3	27	5	70	114010	111630	111664	111647
8.0	2.4	2.3	27	5	70	114011	111631	111665	111648
8.0	2.8	2.3	27	5	70	114012	111632	111666	111649
8.0	2.9	2.3	27	5	70	114013	111633	111667	111650
8.0	3.0	2.3	27	5	70	114014	111634	111668	111651
8.0	3.1	2.3	27	5	70	121828	115551	121829	115550
8.0	3.3	2.3	27	5	70	114015	111635	111669	111652
8.0	3.4	2.3	27	5	70	121831	121832	121833	116207
8.0	3.5	2.3	27	5	70	114016	111636	111670	111653
8.0	3.6	2.3	27	5	70	114017	111637	111671	111654
8.0	3.8	2.3	27	5	70	114018	111638	111672	111655
8.0	4.0	2.3	27	5	70	114019	111639	111673	111656
8.0	4.3	2.3	27	5	70	114020	111640	111674	111657
8.0	4.4	2.3	27	5	70	114021	111641	111675	111658
8.0	4.5	2.3	27	5	70	114022	111642	111676	111659
8.0	4.8	2.3	27	5	70	114023	111643	111677	111660
8.0	5.0	2.3	27	5	70	114024	111644	111678	111661
8.0	5.2	2.3	27	5	70	114025	111645	111679	111662
8.0	5.5	2.3	27	5	70	114026	111646	111680	111663

L mm	W mm	T mm	$\alpha$	$\beta$	$\gamma$	T05CR	T06F
8.5	2.5	2.5	27	5	70	114027	111621
8.5	3.0	2.5	27	5	70	114028	111622
8.5	3.3	2.5	27	5	70	114029	111623
8.5	3.6	2.5	27	5	70	114030	111624
8.5	3.7	2.5	27	5	70	114031	111625
8.5	3.8	2.5	27	5	70	114032	111626
8.5	4.0	2.5	27	5	70	114033	111627
8.5	4.5	2.5	27	5	70	114034	111628
8.5	5.0	2.5	27	5	70	114035	111629
8.5	5.5	2.5	27	5	70	120972	120403



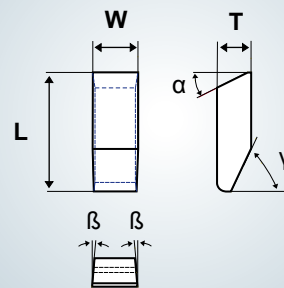

-  Carbide saw tips for circular saws
-  Hartmetallsägezähne für Kreissägen
-  Dents de scie pour scies circulaires
-  Dentelli per lame per rasanti di lame circolari
-  Dientes de sierra para sierras circulares



in mm

L mm	W mm	T mm	$\alpha$	$\beta$	$\gamma$	T05CR	T06CR	T06F
9.0	3.3	2.7	27	5	70	114036	111603	111612
9.0	3.5	2.7	27	5	70	114037	111604	111613
9.0	3.6	2.7	27	5	70	114038	111605	111614
9.0	3.8	2.7	27	5	70	114039	111606	111615
9.0	3.9	2.7	27	5	70	114040	111607	111616
9.0	4.0	2.7	27	5	70	114041	111608	111617
9.0	4.2	2.7	27	5	70	114042	111609	111618
9.0	4.3	2.7	27	5	70	114043	111610	111619
9.0	4.7	2.7	27	5	70	114044	111611	111620

L mm	W mm	T mm	$\alpha$	$\beta$	$\gamma$	T05CR	T06CR	T04F	T06F
10.5	2.7	2.5	27	5	70	114045	111564	111590	111577
10.5	3.0	2.5	27	5	70	114046	111565	111591	111578
10.5	3.3	2.5	27	5	70	114047	112436	112438	112437
10.5	3.4	2.5	27	5	70	114048	111566	111592	111579
10.5	3.5	2.5	27	5	70	114049	111567	111593	111580
10.5	3.6	2.5	27	5	70	114050	111568	111594	111581
10.5	3.7	2.5	27	5	70	114051	111569	111595	111582
10.5	3.8	2.5	27	5	70	114052	111570	111596	111583
10.5	4.0	2.5	27	5	70	114053	111571	111597	111584
10.5	4.3	2.5	27	5	70	114054	111572	111598	111585
10.5	4.5	2.5	27	5	70	114055	111573	111599	111586
10.5	5.0	2.5	27	5	70	114056	111574	111600	111587
10.5	5.5	2.5	27	5	70	114057	111575	111601	111588
10.5	6.0	2.5	27	5	70	121835	121836	121837	119953
10.5	6.5	2.5	27	5	70	114058	111576	111602	111589

-  Carbide saw tips for circular saws
-  Hartmetallsägezähne für Kreissägen
-  Dents de scie pour scies circulaires
-  Dentelli per lame per rasanti di lame circolari
-  Dientes de sierra para sierras circulares

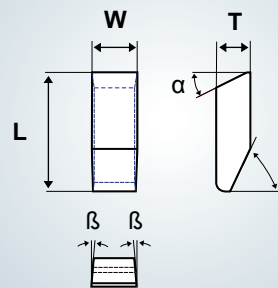





in mm

L mm	W mm	T mm	α	β	γ	T05CR	T06CR	T04F	T06F	T08MF
10.5	3.0	3.0	27	5	65	114059	111488	111526	111507	111545
10.5	3.5	3.0	27	5	65	114060	111489	111527	111508	111546
10.5	3.6	3.0	27	5	65	114061	111490	111528	111509	111547
10.5	3.8	3.0	27	5	65	114062	111491	111529	111510	111548
10.5	4.1	3.0	27	5	65	114063	111492	111530	111511	111549
10.5	4.3	3.0	27	5	65	114064	111493	111531	111512	111550
10.5	4.5	3.0	27	5	65	114065	111494	111532	111513	111551
10.5	4.6	3.0	27	5	65	114066	111495	111533	111514	111552
10.5	4.7	3.0	27	5	65	114067	111496	111534	111515	111553
10.5	4.8	3.0	27	5	65	114068	111497	111535	111516	111554
10.5	5.0	3.0	27	5	65	114069	111498	111536	111517	111555
10.5	5.3	3.0	27	5	65	114070	111499	111537	111518	111556
10.5	5.5	3.0	27	5	65	114071	111500	111538	111519	111557
10.5	5.6	3.0	27	5	65	114072	111501	111539	111520	111558
10.5	6.0	3.0	27	5	65	114073	111502	111540	111521	111559
10.5	6.5	3.0	27	5	65	114074	111503	111541	111522	111560
10.5	7.0	3.0	27	5	65	114075	111504	111542	111523	111561
10.5	8.5	3.0	27	5	65	114076	111505	111543	111524	111562
10.5	10.5	3.0	27	5	65	114077	111506	111544	111525	111563

L mm	W mm	T mm	α	β	γ	T06CR	T06MF	T06F	T08MF
10.5	3.0	3.5	27	5	60	111428	111468	111448	112413
10.5	3.5	3.5	27	5	60	111429	111469	111449	112414
10.5	4.0	3.5	27	5	60	111430	111470	111450	112415
10.5	4.1	3.5	27	5	60	111431	111471	111451	112416
10.5	4.3	3.5	27	5	60	111432	111472	111452	112417
10.5	4.5	3.5	27	5	60	111433	111473	111453	112418
10.5	4.7	3.5	27	5	60	111434	111474	111454	112419
10.5	4.8	3.5	27	5	60	111435	111475	111455	112420
10.5	5.0	3.5	27	5	60	111436	111476	111456	112421
10.5	5.3	3.5	27	5	60	111437	111477	111457	112422
10.5	5.5	3.5	27	5	60	111438	111478	111458	112423
10.5	5.8	3.5	27	5	60	111439	111479	111459	112424
10.5	6.0	3.5	27	5	60	111440	111480	111460	112425
10.5	6.5	3.5	27	5	60	111441	111481	111461	112426
10.5	7.0	3.5	27	5	60	111442	111482	111462	112427
10.5	7.5	3.5	27	5	60	111443	111483	111463	112428
10.5	8.0	3.5	27	5	60	111444	111484	111464	112429
10.5	8.5	3.5	27	5	60	111445	111485	111465	112430
10.5	9.0	3.5	27	5	60	111446	111486	111466	112431
10.5	10.0	3.5	27	5	60	111447	111487	111467	112432





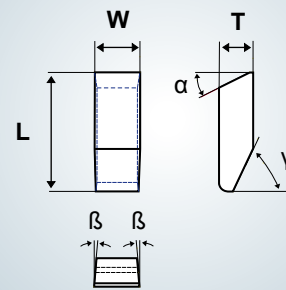

-  Carbide saw tips for circular saws
-  Hartmetallsägezähne für Kreissägen
-  Dents de scie pour scies circulaires
-  Dentelli per lame per rasanti di lame circolari
-  Dientes de sierra para sierras circulares



in mm

L mm	W mm	T mm	α	β	γ	T06CR	T08MF
13.0	3.8	4.0	30	5	60	121838	116278
13.0	4.9	4.0	30	5	60	111410	111419
13.0	5.4	4.0	30	5	60	111411	111420
13.0	5.8	4.0	30	5	60	111412	111421
13.0	6.0	4.0	30	5	60	111413	111422
13.0	6.3	4.0	30	5	60	111414	111423
13.0	6.5	4.0	30	5	60	111415	111424
13.0	6.7	4.0	30	5	60	111416	111425
13.0	7.0	4.0	30	5	60	111417	111426
13.0	7.5	4.0	30	5	60	111418	111427

L mm	W mm	T mm	α	β	γ	T06MF
14.5	5.0	4.0	30	0	70	111390
14.5	5.5	4.0	30	0	70	111391
14.5	6.0	4.0	30	0	70	111392
14.5	6.5	4.0	30	0	70	111393
14.5	7.0	4.0	30	0	70	111394
14.5	7.5	4.0	30	0	70	111395
14.5	8.0	4.0	30	0	70	111396
14.5	9.0	4.0	30	0	70	111397
14.5	10.0	4.0	30	0	70	111398
14.5	10.5	4.0	30	0	70	111399
14.5	11.0	4.0	30	0	70	111400
14.5	12.0	4.0	30	0	70	111401
14.5	13.0	4.0	30	0	70	111402
14.5	14.0	4.0	30	0	70	111403
14.5	15.0	4.0	30	0	70	111404
14.5	16.0	4.0	30	0	70	111405
14.5	17.0	4.0	30	0	70	111406
14.5	18.0	4.0	30	0	70	111407
14.5	19.0	4.0	30	0	70	111408
14.5	20.0	4.0	30	0	70	111409

-  Carbide saw tips for circular saws
-  Hartmetallsägezähne für Kreissägen
-  Dents de scie pour scies circulaires
-  Dentelli per lame per rasanti di lame circolari
-  Dientes de sierra para sierras circulares

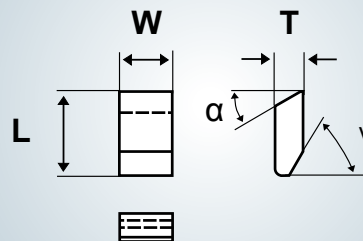





CW-Style  
in inch

CWA	L		W		T		$\alpha$	$\beta$	$\gamma$	T06CR	T10MG	T06MF
	inch	mm	inch	mm	inch	mm						
<b>7130</b>	<b>0.250</b>	6.4	<b>0.130</b>	3.3	<b>0.062</b>	1.6	<b>30</b>	<b>0</b>	<b>60</b>	<b>113812</b>	<b>113816</b>	<b>113820</b>
<b>7160</b>	<b>0.250</b>	6.4	<b>0.160</b>	4.1	<b>0.062</b>	1.6	<b>30</b>	<b>0</b>	<b>60</b>	<b>113813</b>	<b>113817</b>	<b>113821</b>
<b>7180</b>	<b>0.250</b>	6.4	<b>0.180</b>	4.6	<b>0.062</b>	1.6	<b>30</b>	<b>0</b>	<b>60</b>	<b>113814</b>	<b>113818</b>	<b>113822</b>
<b>7200</b>	<b>0.250</b>	6.4	<b>0.200</b>	5.1	<b>0.062</b>	1.6	<b>30</b>	<b>0</b>	<b>60</b>	<b>113815</b>	<b>113819</b>	<b>113823</b>

CWB	L		W		T		$\alpha$	$\beta$	$\gamma$	T06CR	T10MG	T06MF
	inch	mm	inch	mm	inch	mm						
<b>7100</b>	<b>0.281</b>	7.1	<b>0.100</b>	2.5	<b>0.078</b>	2.0	<b>30</b>	<b>0</b>	<b>60</b>	<b>113824</b>	<b>113836</b>	<b>113848</b>
<b>7110</b>	<b>0.281</b>	7.1	<b>0.110</b>	2.8	<b>0.078</b>	2.0	<b>30</b>	<b>0</b>	<b>60</b>	<b>113825</b>	<b>113837</b>	<b>113849</b>
<b>7120</b>	<b>0.281</b>	7.1	<b>0.120</b>	3.0	<b>0.078</b>	2.0	<b>30</b>	<b>0</b>	<b>60</b>	<b>113826</b>	<b>113838</b>	<b>113850</b>
<b>7135</b>	<b>0.281</b>	7.1	<b>0.135</b>	3.4	<b>0.078</b>	2.0	<b>30</b>	<b>0</b>	<b>60</b>	<b>113827</b>	<b>113839</b>	<b>113851</b>
<b>7150</b>	<b>0.281</b>	7.1	<b>0.150</b>	3.8	<b>0.078</b>	2.0	<b>30</b>	<b>0</b>	<b>60</b>	<b>113828</b>	<b>113840</b>	<b>113852</b>
<b>7165</b>	<b>0.281</b>	7.1	<b>0.165</b>	4.2	<b>0.078</b>	2.0	<b>30</b>	<b>0</b>	<b>60</b>	<b>113829</b>	<b>113841</b>	<b>113853</b>
<b>7170</b>	<b>0.281</b>	7.1	<b>0.170</b>	4.3	<b>0.078</b>	2.0	<b>30</b>	<b>0</b>	<b>60</b>	<b>113830</b>	<b>113842</b>	<b>113854</b>
<b>7180</b>	<b>0.281</b>	7.1	<b>0.180</b>	4.6	<b>0.078</b>	2.0	<b>30</b>	<b>0</b>	<b>60</b>	<b>113831</b>	<b>113843</b>	<b>113855</b>
<b>7195</b>	<b>0.281</b>	7.1	<b>0.195</b>	5.0	<b>0.078</b>	2.0	<b>30</b>	<b>0</b>	<b>60</b>	<b>113832</b>	<b>113844</b>	<b>113856</b>
<b>7200</b>	<b>0.281</b>	7.1	<b>0.200</b>	5.1	<b>0.078</b>	2.0	<b>30</b>	<b>0</b>	<b>60</b>	<b>113833</b>	<b>113845</b>	<b>113857</b>
<b>7215</b>	<b>0.281</b>	7.1	<b>0.215</b>	5.5	<b>0.078</b>	2.0	<b>30</b>	<b>0</b>	<b>60</b>	<b>113834</b>	<b>113846</b>	<b>113858</b>
<b>7230</b>	<b>0.281</b>	7.1	<b>0.230</b>	5.8	<b>0.078</b>	2.0	<b>30</b>	<b>0</b>	<b>60</b>	<b>113835</b>	<b>113847</b>	<b>113859</b>

CWC	L		W		T		$\alpha$	$\beta$	$\gamma$	T04F	T06MF
	inch	mm	inch	mm	inch	mm					
<b>7100</b>	<b>0.281</b>	7.1	<b>0.100</b>	2.5	<b>0.093</b>	2.4	<b>30</b>	<b>0</b>	<b>60</b>	<b>113860</b>	<b>113868</b>
<b>7125</b>	<b>0.281</b>	7.1	<b>0.125</b>	3.2	<b>0.093</b>	2.4	<b>30</b>	<b>0</b>	<b>60</b>	<b>113861</b>	<b>113869</b>
<b>7135</b>	<b>0.281</b>	7.1	<b>0.135</b>	3.4	<b>0.093</b>	2.4	<b>30</b>	<b>0</b>	<b>60</b>	<b>113862</b>	<b>113870</b>
<b>7150</b>	<b>0.281</b>	7.1	<b>0.150</b>	3.8	<b>0.093</b>	2.4	<b>30</b>	<b>0</b>	<b>60</b>	<b>113863</b>	<b>113871</b>
<b>7165</b>	<b>0.281</b>	7.1	<b>0.165</b>	4.2	<b>0.093</b>	2.4	<b>30</b>	<b>0</b>	<b>60</b>	<b>113864</b>	<b>113872</b>
<b>7195</b>	<b>0.281</b>	7.1	<b>0.195</b>	5.0	<b>0.093</b>	2.4	<b>30</b>	<b>0</b>	<b>60</b>	<b>113865</b>	<b>113873</b>
<b>7215</b>	<b>0.281</b>	7.1	<b>0.215</b>	5.5	<b>0.093</b>	2.4	<b>30</b>	<b>0</b>	<b>60</b>	<b>113866</b>	<b>113874</b>
<b>7250</b>	<b>0.281</b>	7.1	<b>0.250</b>	6.4	<b>0.093</b>	2.4	<b>30</b>	<b>0</b>	<b>60</b>	<b>113867</b>	<b>113875</b>

Also available pretinned.

-  Carbide saw tips for circular saws
-  Hartmetallsägezähne für Kreissägen
-  Dents de scie pour scies circulaires
-  Dentelli per lame per rasanti di lame circolari
-  Dientes de sierra para sierras circulares

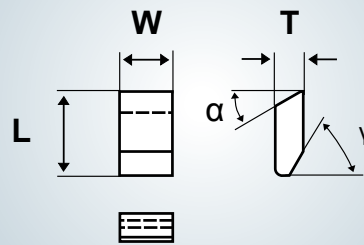





CW-Style  
in inch

CWD	L		W		T		$\alpha$	B	$\gamma$	T06CR	T10MG	T06MF	T15C
	inch	mm	inch	mm	inch	mm							
7100	0.312	7.9	0.100	2.5	0.093	2.4	30	0	60	111288	112629	111311	111334
7110	0.312	7.9	0.110	2.8	0.093	2.4	30	0	60	111289	112630	111312	111335
7115	0.312	7.9	0.115	2.9	0.093	2.4	30	0	60	111290	112631	111313	111336
7120	0.312	7.9	0.120	3.0	0.093	2.4	30	0	60	111291	112632	111314	111337
7125	0.312	7.9	0.125	3.2	0.093	2.4	30	0	60	111292	112633	111315	111338
7130	0.312	7.9	0.130	3.3	0.093	2.4	30	0	60	111293	112634	111316	111339
7135	0.312	7.9	0.135	3.4	0.093	2.4	30	0	60	111294	112635	111317	111340
7140	0.312	7.9	0.140	3.6	0.093	2.4	30	0	60	111295	112636	111318	111341
7150	0.312	7.9	0.150	3.8	0.093	2.4	30	0	60	111296	112637	111319	111342
7160	0.312	7.9	0.160	4.1	0.093	2.4	30	0	60	111297	112638	111320	111343
7165	0.312	7.9	0.165	4.2	0.093	2.4	30	0	60	111298	112639	111321	111344
7170	0.312	7.9	0.170	4.3	0.093	2.4	30	0	60	111299	112640	111322	111345
7175	0.312	7.9	0.175	4.4	0.093	2.4	30	0	60	111300	112641	111323	111346
7180	0.312	7.9	0.180	4.6	0.093	2.4	30	0	60	111301	112642	111324	111347
7185	0.312	7.9	0.185	4.7	0.093	2.4	30	0	60	111302	112643	111325	111348
7190	0.312	7.9	0.190	4.8	0.093	2.4	30	0	60	111303	112644	111326	111349
7200	0.312	7.9	0.200	5.1	0.093	2.4	30	0	60	111304	112645	111327	111350
7215	0.312	7.9	0.215	5.5	0.093	2.4	30	0	60	111305	112646	111328	111351
7220	0.312	7.9	0.220	5.6	0.093	2.4	30	0	60	111306	112647	111329	111352
7230	0.312	7.9	0.230	5.8	0.093	2.4	30	0	60	111307	112648	111330	111353
7240	0.312	7.9	0.240	6.1	0.093	2.4	30	0	60	111308	112649	111331	111354
7250	0.312	7.9	0.250	6.4	0.093	2.4	30	0	60	111309	112650	111332	111355
7280	0.312	7.9	0.280	7.1	0.093	2.4	30	0	60	112653	112651	112654	112655
7312	0.312	7.9	0.312	7.9	0.093	2.4	30	0	60	111310	112652	111333	111356

CWE	L		W		T		$\alpha$	B	$\gamma$	T06CR	T10MG	T06MF
	inch	mm	inch	mm	inch	mm						
7110	0.375	9.5	0.110	2.8	0.093	2.4	30	0	60	112657		
7130	0.375	9.5	0.130	3.3	0.093	2.4	30	0	60	111357	111368	111379
7140	0.375	9.5	0.140	3.6	0.093	2.4	30	0	60	111358	111369	111380
7150	0.375	9.5	0.150	3.8	0.093	2.4	30	0	60	111359	111370	111381
7165	0.375	9.5	0.165	4.2	0.093	2.4	30	0	60	111360	111371	111382
7185	0.375	9.5	0.185	4.7	0.093	2.4	30	0	60	111361	111372	111383
7200	0.375	9.5	0.200	5.1	0.093	2.4	30	0	60	111362	111373	111384
7215	0.375	9.5	0.215	5.5	0.093	2.4	30	0	60	111363	111374	111385
7225	0.375	9.5	0.225	5.7	0.093	2.4	30	0	60	112658	112659	112660
7230	0.375	9.5	0.230	5.8	0.093	2.4	30	0	60	111364	111375	111386
7250	0.375	9.5	0.250	6.4	0.093	2.4	30	0	60	111365	111376	111387
7281	0.375	9.5	0.281	7.1	0.093	2.4	30	0	60	111366	111377	111388
7312	0.375	9.5	0.312	7.9	0.093	2.4	30	0	60	111367	111378	111389

Also available pretinned.





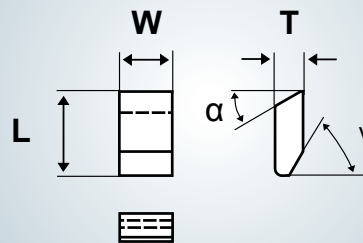

-  Carbide saw tips for circular saws
-  Hartmetallsägezähne für Kreissägen
-  Dents de scie pour scies circulaires
-  Dentelli per lame per rasanti di lame circolari
-  Dientes de sierra para sierras circulares



CW-Style  
in inch

CWF	L		W		T		$\alpha$	$\beta$	$\gamma$	T10MG	T06MF	T12M
	inch	mm	inch	mm	inch	mm						
7110	0.500	12.7	0.110	2.8	0.125	3.2	35	0	70	111225	107257	109391
7115	0.500	12.7	0.115	2.9	0.125	3.2	35	0	70	111226	107258	109392
7120	0.500	12.7	0.120	3.0	0.125	3.2	35	0	70	111227	107259	109393
7125	0.500	12.7	0.125	3.2	0.125	3.2	35	0	70	111228	107260	109394
7130	0.500	12.7	0.130	3.3	0.125	3.2	35	0	70	111229	107261	109395
7140	0.500	12.7	0.140	3.6	0.125	3.2	35	0	70	111230	107263	109397
7150	0.500	12.7	0.150	3.8	0.125	3.2	35	0	70	111231	107265	109399
7160	0.500	12.7	0.160	4.1	0.125	3.2	35	0	70	111232	107266	109400
7165	0.500	12.7	0.165	4.2	0.125	3.2	35	0	70	111233	107267	109401
7170	0.500	12.7	0.170	4.3	0.125	3.2	35	0	70	111234	107268	109402
7180	0.500	12.7	0.180	4.6	0.125	3.2	35	0	70	111235	107269	109403
7185	0.500	12.7	0.185	4.7	0.125	3.2	35	0	70	112661	112663	112664
7190	0.500	12.7	0.190	4.8	0.125	3.2	35	0	70	111236	107271	109405
7200	0.500	12.7	0.200	5.1	0.125	3.2	35	0	70	111237	107272	109406
7210	0.500	12.7	0.210	5.3	0.125	3.2	35	0	70	111238	107273	109407
7215	0.500	12.7	0.215	5.5	0.125	3.2	35	0	70	111239	107274	109408
7220	0.500	12.7	0.220	5.6	0.125	3.2	35	0	70	111240	107275	109409
7230	0.500	12.7	0.230	5.8	0.125	3.2	35	0	70	111241	107276	109410
7240	0.500	12.7	0.240	6.1	0.125	3.2	35	0	70	111242	107278	109412
7250	0.500	12.7	0.250	6.4	0.125	3.2	35	0	70	111243	107279	109413
7260	0.500	12.7	0.260	6.6	0.125	3.2	35	0	70	111244	107280	109414
7270	0.500	12.7	0.270	6.9	0.125	3.2	35	0	70	111245	107282	109416
7275	0.500	12.7	0.275	7.0	0.125	3.2	35	0	70	111246	107283	109417
7280	0.500	12.7	0.280	7.1	0.125	3.2	35	0	70	111247	107284	109418
7290	0.500	12.7	0.290	7.4	0.125	3.2	35	0	70	111248	107285	109419
7300	0.500	12.7	0.300	7.6	0.125	3.2	35	0	70	111249	107286	109420
7310	0.500	12.7	0.310	7.9	0.125	3.2	35	0	70	111250	107287	109421
7312	0.500	12.7	0.312	7.9	0.125	3.2	35	0	70	111251	107288	109422
7330	0.500	12.7	0.330	8.4	0.125	3.2	35	0	70	111252	107290	109424
7375	0.500	12.7	0.375	9.5	0.125	3.2	35	0	70	111253	107294	109428
7400	0.500	12.7	0.400	10.2	0.125	3.2	35	0	70			112666
7437	0.500	12.7	0.437	11.1	0.125	3.2	35	0	70	111254	107297	109431
7500	0.500	12.7	0.500	12.7	0.125	3.2	35	0	70	111255	107298	109432
7625	0.500	12.7	0.625	15.9	0.125	3.2	35	0	70	111256	107300	109434
7687	0.500	12.7	0.687	17.4	0.125	3.2	35	0	70	111257	107301	109435
7750	0.500	12.7	0.750	19.1	0.125	3.2	35	0	70	111258	107302	109436

Also available pretinned.



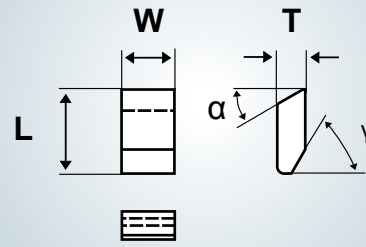

-  Carbide saw tips for circular saws
-  Hartmetallsägezähne für Kreissägen
-  Dents de scie pour scies circulaires
-  Dentelli per lame per rasanti di lame circolari
-  Dientes de sierra para sierras circulares



CW-Style  
in inch

CWG	L		W		T		$\alpha$	$\beta$	$\gamma$	T06CR	T10MG	T06MF	T12M	T15C
	inch	mm	inch	mm	inch	mm								
7110	0.375	9.5	0.110	2.8	0.125	3.2	30	0	60	107349	111259	107383	109437	107417
7120	0.375	9.5	0.120	3.0	0.125	3.2	30	0	60	107350	111260	107384	109438	107418
7125	0.375	9.5	0.125	3.2	0.125	3.2	30	0	60			112667		
7130	0.375	9.5	0.130	3.3	0.125	3.2	30	0	60	107352	111261	107386	109440	107420
7140	0.375	9.5	0.140	3.6	0.125	3.2	30	0	60	107354	111262	107388	109442	107422
7150	0.375	9.5	0.150	3.8	0.125	3.2	30	0	60	107355	111263	107389	109443	107423
7160	0.375	9.5	0.160	4.1	0.125	3.2	30	0	60	107356	111264	107390	109444	107424
7165	0.375	9.5	0.165	4.2	0.125	3.2	30	0	60	107357	111265	107391	109445	107425
7170	0.375	9.5	0.170	4.3	0.125	3.2	30	0	60	107358	111266	107392	109446	107426
7175	0.375	9.5	0.175	4.4	0.125	3.2	30	0	60	107362	111267	107385	109450	107430
7180	0.375	9.5	0.180	4.6	0.125	3.2	30	0	60	107359	111268	107393	109447	107427
7185	0.375	9.5	0.185	4.7	0.125	3.2	30	0	60	107360	111269	107394	109448	107428
7190	0.375	9.5	0.190	4.8	0.125	3.2	30	0	60	107361	111270	107395	109449	107429
7200	0.375	9.5	0.200	5.1	0.125	3.2	30	0	60	107363	111271	107397	109451	107431
7210	0.375	9.5	0.210	5.3	0.125	3.2	30	0	60	107364	111272	107398	109452	107432
7215	0.375	9.5	0.215	5.5	0.125	3.2	30	0	60	107365	111273	107399	109453	107433
7220	0.375	9.5	0.220	5.6	0.125	3.2	30	0	60	107366	111274	107400	109454	107434
7230	0.375	9.5	0.230	5.8	0.125	3.2	30	0	60	107368	111275	107402	109456	107436
7240	0.375	9.5	0.240	6.1	0.125	3.2	30	0	60	107369	111276	107403	109457	107437
7250	0.375	9.5	0.250	6.4	0.125	3.2	30	0	60	107370	111277	107404	109458	107438
7260	0.375	9.5	0.260	6.6	0.125	3.2	30	0	60	107371	111278	107405	109459	107439
7270	0.375	9.5	0.270	6.9	0.125	3.2	30	0	60	107373	111279	107407	109461	107441
7275	0.375	9.5	0.275	7.0	0.125	3.2	30	0	60	107374	111280	107408	109462	107442
7280	0.375	9.5	0.280	7.1	0.125	3.2	30	0	60	107375	111281	107409	109463	107443
7300	0.375	9.5	0.300	7.6	0.125	3.2	30	0	60	107376	111282	107410	109464	107444
7310	0.375	9.5	0.310	7.9	0.125	3.2	30	0	60	107378	111283	107412	109466	107446
7312	0.375	9.5	0.312	7.9	0.125	3.2	30	0	60	107377	111284	107411	109465	107445
7350	0.375	9.5	0.350	8.9	0.125	3.2	30	0	60	107380	111285	107414	109468	111218
7400	0.375	9.5	0.400	10.2	0.125	3.2	30	0	60	107379	111286	107413	109467	107447
7500	0.375	9.5	0.500	12.7	0.125	3.2	30	0	60	107381	111287	107415	109469	107449

Also available pretinned.

-  Carbide saw tips for circular saws
-  Hartmetallsägezähne für Kreissägen
-  Dents de scie pour scies circulaires
-  Dentelli per lame per rasanti di lame circolari
-  Dientes de sierra para sierras circulares

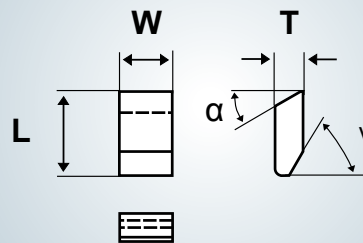





CW-Style  
in inch

CWH	L		W		T		α	β	γ	T06CR	T04F	T06MF
	inch	mm	inch	mm	inch	mm						
7120	0.344	8.7	0.120	3.0	0.125	3.2	30	0	60	114408	114409	114410
7135	0.344	8.7	0.135	3.4	0.125	3.2	30	0	60	114413	114412	114411
7140	0.344	8.7	0.140	3.6	0.125	3.2	30	0	60	114414	114415	114416
7150	0.344	8.7	0.150	3.8	0.125	3.2	30	0	60	114419	114418	114417
7160	0.344	8.7	0.160	4.1	0.125	3.2	30	0	60	114420	114421	114422
7165	0.344	8.7	0.165	4.2	0.125	3.2	30	0	60	114425	114424	114423
7180	0.344	8.7	0.180	4.6	0.125	3.2	30	0	60	114426	114427	114428
7185	0.344	8.7	0.185	4.7	0.125	3.2	30	0	60	114431	114430	114429
7190	0.344	8.7	0.190	4.8	0.125	3.2	30	0	60	114432	114433	114434
7200	0.344	8.7	0.200	5.1	0.125	3.2	30	0	60	114438	114436	114435
7210	0.344	8.7	0.210	5.3	0.125	3.2	30	0	60	114440	114441	114442
7215	0.344	8.7	0.215	5.5	0.125	3.2	30	0	60	114446	114445	114443
7220	0.344	8.7	0.220	5.6	0.125	3.2	30	0	60	114447	114448	114449
7230	0.344	8.7	0.230	5.8	0.125	3.2	30	0	60	114453	114452	114451
7240	0.344	8.7	0.240	6.1	0.125	3.2	30	0	60	114454	114455	114456
7250	0.344	8.7	0.250	6.4	0.125	3.2	30	0	60	114459	114458	114457
7260	0.344	8.7	0.260	6.6	0.125	3.2	30	0	60	114460	114461	114462

CWQ	L		W		T		α	β	γ	T04F	T10MG
	inch	mm	inch	mm	inch	mm					
7200	0.375	9.5	0.200	5.1	0.156	4.0	30	0	60	114463	114464
7230	0.375	9.5	0.230	5.8	0.156	4.0	30	0	60	114466	114465
7250	0.375	9.5	0.250	6.4	0.156	4.0	30	0	60	114467	114468
7300	0.375	9.5	0.300	7.6	0.156	4.0	30	0	60	114470	114469
7400	0.375	9.5	0.400	10.2	0.156	4.0	30	0	60	114471	114472
7530	0.375	9.5	0.530	13.5	0.156	4.0	30	0	60	114474	114473
7625	0.375	9.5	0.625	15.9	0.156	4.0	30	0	60	114475	114476

Also available pretinned.



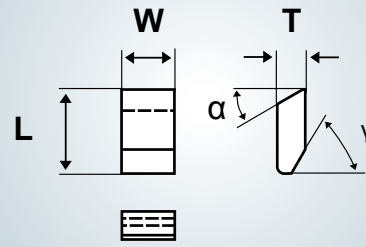

-  Carbide saw tips for circular saws
-  Hartmetallsägezähne für Kreissägen
-  Dents de scie pour scies circulaires
-  Dentelli per lame per rasanti di lame circolari
-  Dientes de sierra para sierras circulares





**CW-Style**  
in inch

	CWD Right	L inch mm	W inch mm	T inch mm	$\alpha$	B	$\gamma$	T06CR	T10MG	T06MF
	<b>7165</b>	0.312 7.9	0.165 4.2	0.093 2.4	30	0	60	111691	111701	111711
	<b>7185</b>	0.312 7.9	0.185 4.7	0.093 2.4	30	0	60	111693	111703	111713
	<b>7200</b>	0.312 7.9	0.200 5.1	0.093 2.4	30	0	60	111695	111705	111715
	<b>7215</b>	0.312 7.9	0.215 5.5	0.093 2.4	30	0	60	111697	111707	111717
	<b>7250</b>	0.312 7.9	0.250 6.4	0.093 2.4	30	0	60	111699	111709	111719

	CWD Left	L inch mm	W inch mm	T inch mm	$\alpha$	B	$\gamma$	T06CR	T10MG	T06MF
	<b>7165</b>	0.312 7.9	0.165 4.2	0.093 2.4	30	0	60	111692	111702	111712
	<b>7185</b>	0.312 7.9	0.185 4.7	0.093 2.4	30	0	60	111694	111704	111714
	<b>7200</b>	0.312 7.9	0.200 5.1	0.093 2.4	30	0	60	111696	111706	111716
	<b>7215</b>	0.312 7.9	0.215 5.5	0.093 2.4	30	0	60	111698	111708	111718
	<b>7250</b>	0.312 7.9	0.250 6.4	0.093 2.4	30	0	60	111700	111710	111720





	CWG Right	L inch mm	W inch mm	T inch mm	$\alpha$	B	$\gamma$	T06MF	T15C
	<b>7230</b>	0.375 9.5	0.230 5.8	0.125 3.2	30	0	60	107457	107451
	<b>7250</b>	0.375 9.5	0.250 6.4	0.125 3.2	30	0	60	107459	107453
	<b>7265</b>	0.375 9.5	0.265 6.7	0.125 3.2	30	0	60	107463	107465
	<b>7270</b>	0.375 9.5	0.270 6.9	0.125 3.2	30	0	60	107461	107455

	CWG Left	L inch mm	W inch mm	T inch mm	$\alpha$	B	$\gamma$	T06MF	T15C
	<b>7230</b>	0.375 9.5	0.230 5.8	0.125 3.2	30	0	60	107458	107452
	<b>7250</b>	0.375 9.5	0.250 6.4	0.125 3.2	30	0	60	107460	107454
	<b>7265</b>	0.375 9.5	0.265 6.7	0.125 3.2	30	0	60	107464	107466
	<b>7270</b>	0.375 9.5	0.270 6.9	0.125 3.2	30	0	60	107462	107456

	CWEV	L inch mm	W inch mm	T inch mm	$\alpha$	B	$\gamma$	T06MF
	<b>7200</b>	0.375 9.5	0.200 5.1	0.093 2.4	30	0	60	119868

Also available pretinned.



-  Carbide saw tips for circular saws
-  Hartmetallsägezähne für Kreissägen
-  Dents de scie pour scies circulaires
-  Dentelli per lame per rasanti di lame circolari
-  Dientes de sierra para sierras circulares

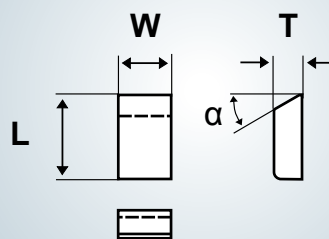





W-Style  
in inch

WA	L		W		T		$\alpha$	$\beta$	$\gamma$	T04F	T06MF
	inch	mm	inch	mm	inch	mm					
7080	0.250	6.4	0.080	2.0	0.062	1.6	30	0	0	114136	114137
7090	0.250	6.4	0.090	2.3	0.062	1.6	30	0	0	114139	114138
7100	0.250	6.4	0.100	2.5	0.062	1.6	30	0	0	114140	114141
7110	0.250	6.4	0.110	2.8	0.062	1.6	30	0	0	114143	114142
7115	0.250	6.4	0.115	2.9	0.062	1.6	30	0	0	114144	114145
7120	0.250	6.4	0.120	3.0	0.062	1.6	30	0	0	114147	114146
7130	0.250	6.4	0.130	3.3	0.062	1.6	30	0	0	114148	114149
7145	0.250	6.4	0.145	3.7	0.062	1.6	30	0	0	114151	114150
7160	0.250	6.4	0.160	4.1	0.062	1.6	30	0	0	114152	114153
7180	0.250	6.4	0.180	4.6	0.062	1.6	30	0	0	114155	114154
7200	0.250	6.4	0.200	5.1	0.062	1.6	30	0	0	114156	114157
7215	0.250	6.4	0.215	5.5	0.062	1.6	30	0	0	114160	114158

WB	L		W		T		$\alpha$	$\beta$	$\gamma$	T06MF	T10MG
	inch	mm	inch	mm	inch	mm					
7100	0.281	7.1	0.100	2.5	0.078	2.0	30	0	0	114161	114162
7105	0.281	7.1	0.105	2.7	0.078	2.0	30	0	0	114164	114163
7120	0.281	7.1	0.120	3.0	0.078	2.0	30	0	0	114165	114166
7135	0.281	7.1	0.135	3.4	0.078	2.0	30	0	0	114168	114167
7150	0.281	7.1	0.150	3.8	0.078	2.0	30	0	0	114169	114170
7165	0.281	7.1	0.165	4.2	0.078	2.0	30	0	0	114172	114171
7180	0.281	7.1	0.180	4.6	0.078	2.0	30	0	0	114173	114174
7185	0.281	7.1	0.185	4.7	0.078	2.0	30	0	0	114176	114175
7195	0.281	7.1	0.195	5.0	0.078	2.0	30	0	0	114177	114178
7200	0.281	7.1	0.200	5.1	0.078	2.0	30	0	0	114180	114179
7215	0.281	7.1	0.215	5.5	0.078	2.0	30	0	0	114181	114182
7250	0.281	7.1	0.250	6.4	0.078	2.0	30	0	0	114184	114183

WC	L		W		T		$\alpha$	$\beta$	$\gamma$	T04F	T06MF
	inch	mm	inch	mm	inch	mm					
7100	0.281	7.1	0.100	2.5	0.093	2.4	30	0	0	114185	114186
7125	0.281	7.1	0.125	3.2	0.093	2.4	30	0	0	114188	114187
7135	0.281	7.1	0.135	3.4	0.093	2.4	30	0	0	114189	114190
7150	0.281	7.1	0.150	3.8	0.093	2.4	30	0	0	114192	114191
7165	0.281	7.1	0.165	4.2	0.093	2.4	30	0	0	114193	114194



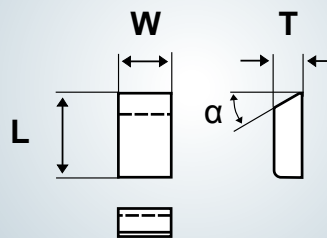

-  Carbide saw tips for circular saws
-  Hartmetallsägezähne für Kreissägen
-  Dents de scie pour scies circulaires
-  Dentelli per lame per rasanti di lame circolari
-  Dientes de sierra para sierras circulares



W-Style  
in inch

WD	L		W		T		$\alpha$	B	$\gamma$	T06CR	T04F	T06MF	T10MG
	inch	mm	inch	mm	inch	mm							
7100	0.312	7.9	0.100	2.5	0.093	2.4	30	0	0	114195	114196	114197	114198
7110	0.312	7.9	0.110	2.8	0.093	2.4	30	0	0	114202	114201	114200	114199
7115	0.312	7.9	0.115	2.9	0.093	2.4	30	0	0	114203	114204	114205	114206
7120	0.312	7.9	0.120	3.0	0.093	2.4	30	0	0	114210	114209	114208	114207
7135	0.312	7.9	0.135	3.4	0.093	2.4	30	0	0	114211	114212	114213	114214
7140	0.312	7.9	0.140	3.6	0.093	2.4	30	0	0	114218	114217	114216	114215
7150	0.312	7.9	0.150	3.8	0.093	2.4	30	0	0	114219	114220	114221	114222
7160	0.312	7.9	0.160	4.1	0.093	2.4	30	0	0	114226	114225	114224	114223
7165	0.312	7.9	0.165	4.2	0.093	2.4	30	0	0	114227	114228	114229	114230
7170	0.312	7.9	0.170	4.3	0.093	2.4	30	0	0	114234	114233	114232	114231
7185	0.312	7.9	0.185	4.7	0.093	2.4	30	0	0	114235	114237	114238	114239
7190	0.312	7.9	0.190	4.8	0.093	2.4	30	0	0	114243	114242	114241	114240
7200	0.312	7.9	0.200	5.1	0.093	2.4	30	0	0	114244	114245	114246	114247
7215	0.312	7.9	0.215	5.5	0.093	2.4	30	0	0	114251	114250	114249	114248
7230	0.312	7.9	0.230	5.8	0.093	2.4	30	0	0	114252	114253	114254	114255
7240	0.312	7.9	0.240	6.1	0.093	2.4	30	0	0	114259	114258	114257	114256
7250	0.312	7.9	0.250	6.4	0.093	2.4	30	0	0	114260	114261	114262	114263
7280	0.312	7.9	0.280	7.1	0.093	2.4	30	0	0	114267	114266	114265	114264
7312	0.312	7.9	0.312	7.9	0.093	2.4	30	0	0	114268	114269	114270	114271



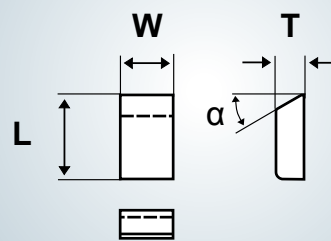

WE	L		W		T		$\alpha$	B	$\gamma$	T06CR	T06MF	T10MG
	inch	mm	inch	mm	inch	mm						
7110	0.375	9.5	0.110	2.8	0.093	2.4	30	0	0	114274	114273	114272
7130	0.375	9.5	0.130	3.3	0.093	2.4	30	0	0	114275	114276	114277
7135	0.375	9.5	0.135	3.4	0.093	2.4	30	0	0	114280	114279	114278
7140	0.375	9.5	0.140	3.6	0.093	2.4	30	0	0	114281	114282	114283
7150	0.375	9.5	0.150	3.8	0.093	2.4	30	0	0	114286	114285	114284
7165	0.375	9.5	0.165	4.2	0.093	2.4	30	0	0	114288	114289	114290
7170	0.375	9.5	0.170	4.3	0.093	2.4	30	0	0	114293	114292	114291
7185	0.375	9.5	0.185	4.7	0.093	2.4	30	0	0	114294	114295	114296
7200	0.375	9.5	0.200	5.1	0.093	2.4	30	0	0	114299	114298	114297
7215	0.375	9.5	0.215	5.5	0.093	2.4	30	0	0	114300	114301	114302
7225	0.375	9.5	0.225	5.7	0.093	2.4	30	0	0	114305	114304	114303
7235	0.375	9.5	0.235	6.0	0.093	2.4	30	0	0	114306	114307	114308
7250	0.375	9.5	0.250	6.4	0.093	2.4	30	0	0	114311	114310	114309
7265	0.375	9.5	0.265	6.7	0.093	2.4	30	0	0	114312	114313	114314
7281	0.375	9.5	0.281	7.1	0.093	2.4	30	0	0	114317	114316	114315
7312	0.375	9.5	0.312	7.9	0.093	2.4	30	0	0	114318	114319	114320
7350	0.375	9.5	0.350	8.9	0.093	2.4	30	0	0	114323	114322	114321
7375	0.375	9.5	0.375	9.5	0.093	2.4	30	0	0	114324	114325	114326

-  Carbide saw tips for circular saws
-  Hartmetallsägezähne für Kreissägen
-  Dents de scie pour scies circulaires
-  Dentelli per lame per rasanti di lame circolari
-  Dientes de sierra para sierras circulares



W-Style  
in inch

WF	L		W		T		$\alpha$	$\beta$	$\gamma$	T06MF	T10MG
	inch	mm	inch	mm	inch	mm					
<b>7150</b>	<b>0.500</b>	12.7	<b>0.150</b>	3.8	<b>0.125</b>	3.2	<b>35</b>	<b>0</b>	<b>0</b>	<b>114328</b>	<b>114327</b>
<b>7160</b>	<b>0.500</b>	12.7	<b>0.160</b>	4.1	<b>0.125</b>	3.2	<b>35</b>	<b>0</b>	<b>0</b>	<b>114329</b>	<b>114330</b>
<b>7165</b>	<b>0.500</b>	12.7	<b>0.165</b>	4.2	<b>0.125</b>	3.2	<b>35</b>	<b>0</b>	<b>0</b>	<b>114332</b>	<b>114334</b>
<b>7170</b>	<b>0.500</b>	12.7	<b>0.170</b>	4.3	<b>0.125</b>	3.2	<b>35</b>	<b>0</b>	<b>0</b>	<b>114336</b>	<b>114335</b>
<b>7180</b>	<b>0.500</b>	12.7	<b>0.180</b>	4.6	<b>0.125</b>	3.2	<b>35</b>	<b>0</b>	<b>0</b>	<b>114337</b>	<b>114338</b>
<b>7185</b>	<b>0.500</b>	12.7	<b>0.185</b>	4.7	<b>0.125</b>	3.2	<b>35</b>	<b>0</b>	<b>0</b>	<b>114340</b>	<b>114339</b>
<b>7190</b>	<b>0.500</b>	12.7	<b>0.190</b>	4.8	<b>0.125</b>	3.2	<b>35</b>	<b>0</b>	<b>0</b>	<b>114341</b>	<b>114342</b>
<b>7200</b>	<b>0.500</b>	12.7	<b>0.200</b>	5.1	<b>0.125</b>	3.2	<b>35</b>	<b>0</b>	<b>0</b>	<b>114344</b>	<b>114343</b>
<b>7210</b>	<b>0.500</b>	12.7	<b>0.210</b>	5.3	<b>0.125</b>	3.2	<b>35</b>	<b>0</b>	<b>0</b>	<b>114345</b>	<b>114346</b>
<b>7215</b>	<b>0.500</b>	12.7	<b>0.215</b>	5.5	<b>0.125</b>	3.2	<b>35</b>	<b>0</b>	<b>0</b>	<b>114348</b>	<b>114347</b>
<b>7220</b>	<b>0.500</b>	12.7	<b>0.220</b>	5.6	<b>0.125</b>	3.2	<b>35</b>	<b>0</b>	<b>0</b>	<b>114349</b>	<b>114350</b>
<b>7230</b>	<b>0.500</b>	12.7	<b>0.230</b>	5.8	<b>0.125</b>	3.2	<b>35</b>	<b>0</b>	<b>0</b>	<b>114352</b>	<b>114351</b>
<b>7240</b>	<b>0.500</b>	12.7	<b>0.240</b>	6.1	<b>0.125</b>	3.2	<b>35</b>	<b>0</b>	<b>0</b>	<b>114353</b>	<b>114354</b>
<b>7250</b>	<b>0.500</b>	12.7	<b>0.250</b>	6.4	<b>0.125</b>	3.2	<b>35</b>	<b>0</b>	<b>0</b>	<b>114356</b>	<b>114355</b>
<b>7260</b>	<b>0.500</b>	12.7	<b>0.260</b>	6.6	<b>0.125</b>	3.2	<b>35</b>	<b>0</b>	<b>0</b>	<b>114357</b>	<b>114358</b>
<b>7270</b>	<b>0.500</b>	12.7	<b>0.270</b>	6.9	<b>0.125</b>	3.2	<b>35</b>	<b>0</b>	<b>0</b>	<b>114360</b>	<b>114359</b>
<b>7275</b>	<b>0.500</b>	12.7	<b>0.275</b>	7.0	<b>0.125</b>	3.2	<b>35</b>	<b>0</b>	<b>0</b>	<b>114361</b>	<b>114362</b>
<b>7280</b>	<b>0.500</b>	12.7	<b>0.280</b>	7.1	<b>0.125</b>	3.2	<b>35</b>	<b>0</b>	<b>0</b>	<b>114364</b>	<b>114363</b>
<b>7300</b>	<b>0.500</b>	12.7	<b>0.300</b>	7.6	<b>0.125</b>	3.2	<b>35</b>	<b>0</b>	<b>0</b>	<b>114365</b>	<b>114366</b>
<b>7312</b>	<b>0.500</b>	12.7	<b>0.312</b>	7.9	<b>0.125</b>	3.2	<b>35</b>	<b>0</b>	<b>0</b>	<b>114368</b>	<b>114367</b>
<b>7350</b>	<b>0.500</b>	12.7	<b>0.350</b>	8.9	<b>0.125</b>	3.2	<b>35</b>	<b>0</b>	<b>0</b>	<b>114369</b>	<b>114370</b>
<b>7375</b>	<b>0.500</b>	12.7	<b>0.375</b>	9.5	<b>0.125</b>	3.2	<b>35</b>	<b>0</b>	<b>0</b>	<b>114372</b>	<b>114371</b>
<b>7400</b>	<b>0.500</b>	12.7	<b>0.400</b>	10.2	<b>0.125</b>	3.2	<b>35</b>	<b>0</b>	<b>0</b>	<b>114373</b>	<b>114374</b>
<b>7437</b>	<b>0.500</b>	12.7	<b>0.437</b>	11.1	<b>0.125</b>	3.2	<b>35</b>	<b>0</b>	<b>0</b>	<b>114376</b>	<b>114375</b>
<b>7500</b>	<b>0.500</b>	12.7	<b>0.500</b>	12.7	<b>0.125</b>	3.2	<b>35</b>	<b>0</b>	<b>0</b>	<b>114377</b>	<b>114378</b>
<b>7625</b>	<b>0.500</b>	12.7	<b>0.625</b>	15.9	<b>0.125</b>	3.2	<b>35</b>	<b>0</b>	<b>0</b>	<b>114380</b>	<b>114379</b>

-  Carbide saw tips for circular saws
-  Hartmetallsägezähne für Kreissägen
-  Dents de scie pour scies circulaires
-  Dentelli per lame per rasanti di lame circolari
-  Dientes de sierra para sierras circulares

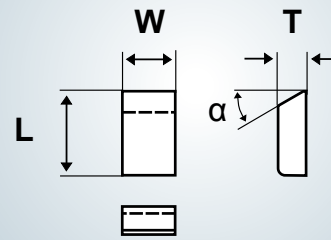

W-Style  
in inch

WG	L		W		T		α	β	γ	T06MF
	inch	mm	inch	mm	inch	mm				
7150	0.375	9.5	0.150	3.8	0.125	3.2	30	0	0	114381
7165	0.375	9.5	0.165	4.2	0.125	3.2	30	0	0	114382
7180	0.375	9.5	0.180	4.6	0.125	3.2	30	0	0	114383
7185	0.375	9.5	0.185	4.7	0.125	3.2	30	0	0	114384
7190	0.375	9.5	0.190	4.8	0.125	3.2	30	0	0	114385
7200	0.375	9.5	0.200	5.1	0.125	3.2	30	0	0	114386
7215	0.375	9.5	0.215	5.5	0.125	3.2	30	0	0	114387
7220	0.375	9.5	0.220	5.6	0.125	3.2	30	0	0	114388
7230	0.375	9.5	0.230	5.8	0.125	3.2	30	0	0	114389
7240	0.375	9.5	0.240	6.1	0.125	3.2	30	0	0	114390
7250	0.375	9.5	0.250	6.4	0.125	3.2	30	0	0	114391
7265	0.375	9.5	0.265	6.7	0.125	3.2	30	0	0	114392
7275	0.375	9.5	0.275	7.0	0.125	3.2	30	0	0	114393
7280	0.375	9.5	0.280	7.1	0.125	3.2	30	0	0	114394
7300	0.375	9.5	0.300	7.6	0.125	3.2	30	0	0	114395
7312	0.375	9.5	0.312	7.9	0.125	3.2	30	0	0	114396
7350	0.375	9.5	0.350	8.9	0.125	3.2	30	0	0	114397
7400	0.375	9.5	0.400	10.2	0.125	3.2	30	0	0	114398
7500	0.375	9.5	0.500	12.7	0.125	3.2	30	0	0	114399

WQ	L		W		T		α	β	γ	T10MG
	inch	mm	inch	mm	inch	mm				
7200	0.375	9.5	0.200	5.1	0.156	4.0	30	0	0	114400
7265	0.375	9.5	0.265	6.7	0.156	4.0	30	0	0	114401
7300	0.375	9.5	0.300	7.6	0.156	4.0	30	0	0	114402
7335	0.375	9.5	0.335	8.5	0.156	4.0	30	0	0	114403
7400	0.375	9.5	0.400	10.2	0.156	4.0	30	0	0	114404
7460	0.375	9.5	0.460	11.7	0.156	4.0	30	0	0	114405
7500	0.375	9.5	0.500	12.7	0.156	4.0	30	0	0	114406
7625	0.375	9.5	0.625	15.9	0.156	4.0	30	0	0	114407

 Strobe blanks for circular saws

 Wischerblätter für Kreissägen

 Racleurs pour scies circulaires

 Barrette per rasanti di lame circolari

 Rasuradores para sierras circulares

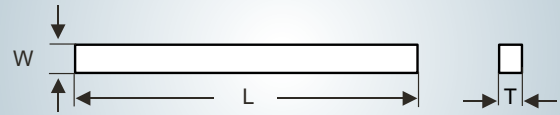

in mm

L mm	W mm	T mm	T06MF
25	2	2	111033
30	2	2	111034
35	2	2	113524
310	2	2	113525
30	2.3	2	113526
40	2.3	2	111040
310	2.3	2	113527
25	2.5	2	113529
30	2.5	2	111035
35	2.5	2	113531
45	2.5	2	111044
310	2.5	2	113532
25	3	2	109812
30	3	2	043520
35	3	2	113533
40	3	2	043522
50	3	2	113541
310	3	2	113542
30	3.3	2	049602
35	3.3	2	113544
40	3.3	2	113546
50	3.3	2	113549
55	3.3	2	113551
60	3.3	2	113553
310	3.3	2	113555
30	3.5	2	043514
40	3.5	2	043516
45	3.5	2	113557
50	3.5	2	109811
310	3.5	2	113564
30	3.7	2	036174
40	3.7	2	113565
50	3.7	2	113566
55	3.7	2	113567
70	3.7	2	113568
310	3.7	2	113569
20	4	2	111032
30	4	2	043521
35	4	2	113572
40	4	2	043523
45	4	2	113574
50	4	2	111046
55	4	2	113576
60	4	2	111049

L mm	W mm	T mm	T06MF
65	4	2	113577
310	4	2	113578
50	4.2	2	036811
60	4.2	2	113582
70	4.2	2	113583
310	4.2	2	113584
30	4.5	2	111037
40	4.5	2	111041
45	4.5	2	111045
50	4.5	2	111047
55	4.5	2	113585
60	4.5	2	111050
65	4.5	2	113590
70	4.5	2	113591
310	4.5	2	113592
310	4.7	2	113593
40	5	2	043525
45	5	2	113594
50	5	2	113595
55	5	2	113596
60	5	2	111051
65	5	2	113597
310	5	2	113598
30	5.2	2	111038
30	5.5	2	111039
40	5.5	2	111042
50	5.5	2	111048
60	5.5	2	113599
65	5.5	2	113600
310	5.5	2	113773
40	5.8	2	111043
60	5.8	2	111052
310	5.8	2	113601
60	6	2	113602
65	6	2	113603
310	6	2	113604
60	6.2	2	111053
310	6.5	2	113605
310	7	2	113606
310	7.5	2	113607



 Strobe blanks for circular saws

 Wischerblätter für Kreissägen

 Racleurs pour scies circulaires

 Barrette per rasanti di lame circolari



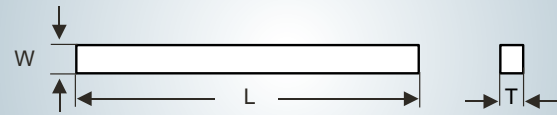

 Rasuradores para sierras circulares



in inch

ST	L		W		T		T08MF
	inch	mm	inch	mm	inch	mm	
<b>ST1120</b>	<b>1.000</b>	25.4	<b>0.120</b>	3.0	<b>0.125</b>	3.2	<b>113528</b>
<b>ST1130</b>	<b>1.000</b>	25.4	<b>0.130</b>	3.3	<b>0.125</b>	3.2	<b>113530</b>
<b>ST1140</b>	<b>1.000</b>	25.4	<b>0.140</b>	3.6	<b>0.125</b>	3.2	<b>113534</b>
<b>ST1150</b>	<b>1.000</b>	25.4	<b>0.150</b>	3.8	<b>0.125</b>	3.2	<b>113535</b>
<b>ST1160</b>	<b>1.000</b>	25.4	<b>0.160</b>	4.1	<b>0.125</b>	3.2	<b>113536</b>
<b>ST1170</b>	<b>1.000</b>	25.4	<b>0.170</b>	4.3	<b>0.125</b>	3.2	<b>113537</b>
<b>ST1180</b>	<b>1.000</b>	25.4	<b>0.180</b>	4.6	<b>0.125</b>	3.2	<b>113538</b>
<b>ST1190</b>	<b>1.000</b>	25.4	<b>0.190</b>	4.8	<b>0.125</b>	3.2	<b>113539</b>
<b>ST1200</b>	<b>1.000</b>	25.4	<b>0.200</b>	5.1	<b>0.125</b>	3.2	<b>113540</b>
<b>ST1210</b>	<b>1.000</b>	25.4	<b>0.210</b>	5.3	<b>0.125</b>	3.2	<b>113543</b>
<b>ST1220</b>	<b>1.000</b>	25.4	<b>0.220</b>	5.6	<b>0.125</b>	3.2	<b>113545</b>
<b>ST1230</b>	<b>1.000</b>	25.4	<b>0.230</b>	5.8	<b>0.125</b>	3.2	<b>113547</b>
<b>ST1240</b>	<b>1.000</b>	25.4	<b>0.240</b>	6.1	<b>0.125</b>	3.2	<b>113548</b>
<b>ST1250</b>	<b>1.000</b>	25.4	<b>0.250</b>	6.4	<b>0.125</b>	3.2	<b>113550</b>
<b>ST1260</b>	<b>1.000</b>	25.4	<b>0.260</b>	6.6	<b>0.125</b>	3.2	<b>113552</b>
<b>ST1270</b>	<b>1.000</b>	25.4	<b>0.270</b>	6.9	<b>0.125</b>	3.2	<b>114089</b>
<b>ST1280</b>	<b>1.000</b>	25.4	<b>0.280</b>	7.1	<b>0.125</b>	3.2	<b>113554</b>
<b>ST1290</b>	<b>1.000</b>	25.4	<b>0.290</b>	7.4	<b>0.125</b>	3.2	<b>113556</b>

ST	L		W		T		T08MF
	inch	mm	inch	mm	inch	mm	
<b>ST2120</b>	<b>1.250</b>	31.8	<b>0.120</b>	3.0	<b>0.125</b>	3.2	<b>113558</b>
<b>ST2130</b>	<b>1.250</b>	31.8	<b>0.130</b>	3.3	<b>0.125</b>	3.2	<b>113559</b>
<b>ST2140</b>	<b>1.250</b>	31.8	<b>0.140</b>	3.6	<b>0.125</b>	3.2	<b>113560</b>
<b>ST2150</b>	<b>1.250</b>	31.8	<b>0.150</b>	3.8	<b>0.125</b>	3.2	<b>113561</b>
<b>ST2160</b>	<b>1.250</b>	31.8	<b>0.160</b>	4.1	<b>0.125</b>	3.2	<b>113562</b>
<b>ST2170</b>	<b>1.250</b>	31.8	<b>0.170</b>	4.3	<b>0.125</b>	3.2	<b>113563</b>
<b>ST2180</b>	<b>1.250</b>	31.8	<b>0.180</b>	4.6	<b>0.125</b>	3.2	<b>113570</b>
<b>ST2190</b>	<b>1.250</b>	31.8	<b>0.190</b>	4.8	<b>0.125</b>	3.2	<b>113571</b>
<b>ST2200</b>	<b>1.250</b>	31.8	<b>0.200</b>	5.1	<b>0.125</b>	3.2	<b>113573</b>
<b>ST2210</b>	<b>1.250</b>	31.8	<b>0.210</b>	5.3	<b>0.125</b>	3.2	<b>113575</b>
<b>ST2220</b>	<b>1.250</b>	31.8	<b>0.220</b>	5.6	<b>0.125</b>	3.2	<b>113579</b>
<b>ST2230</b>	<b>1.250</b>	31.8	<b>0.230</b>	5.8	<b>0.125</b>	3.2	<b>113580</b>
<b>ST2240</b>	<b>1.250</b>	31.8	<b>0.240</b>	6.1	<b>0.125</b>	3.2	<b>113581</b>
<b>ST2250</b>	<b>1.250</b>	31.8	<b>0.250</b>	6.4	<b>0.125</b>	3.2	<b>113586</b>
<b>ST2260</b>	<b>1.250</b>	31.8	<b>0.260</b>	6.6	<b>0.125</b>	3.2	<b>113587</b>
<b>ST2280</b>	<b>1.250</b>	31.8	<b>0.280</b>	7.1	<b>0.125</b>	3.2	<b>113588</b>
<b>ST2290</b>	<b>1.250</b>	31.8	<b>0.290</b>	7.4	<b>0.125</b>	3.2	<b>113589</b>

-  Pretinned saw tips
-  Lotbeschichtete Sägezähne
-  Dents de scie pré-brasées
-  Dentelli saldo-brasati per lame
-  Dientes de sierra con solda

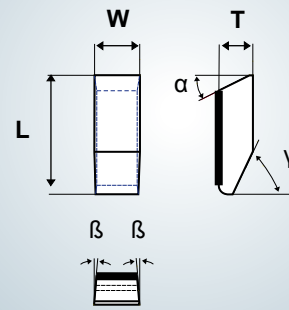





in mm

L mm	W mm	T mm	$\alpha$	B	$\gamma$	T06F
8.0	2.9	2.3	27	5	70	113777
8.0	3.0	2.3	27	5	70	113778
8.0	3.4	2.3	27	5	70	116199
8.0	3.6	2.3	27	5	70	113779
8.0	3.8	2.3	27	5	70	116159
8.0	4.0	2.3	27	5	70	116200
8.0	4.3	2.3	27	5	70	113780
8.0	4.5	2.3	27	5	70	116201
8.0	5.0	2.3	27	5	70	116202
8.0	5.5	2.3	27	5	70	116203

L mm	W mm	T mm	$\alpha$	B	$\gamma$	T06F
8.5	3.8	2.5	27	5	70	113781
8.5	4.0	2.5	27	5	70	113782
8.5	4.5	2.5	27	5	70	113783
8.5	5.0	2.5	27	5	70	113784

L mm	W mm	T mm	$\alpha$	B	$\gamma$	T06F
10.5	3.0	2.5	27	5	70	113785
10.5	3.3	2.5	27	5	70	113786
10.5	3.4	2.5	27	5	70	113787
10.5	3.8	2.5	27	5	70	113788
10.5	4.0	2.5	27	5	70	113789
10.5	4.3	2.5	27	5	70	113790
10.5	4.5	2.5	27	5	70	113791
10.5	5.0	2.5	27	5	70	113792
10.5	5.5	2.5	27	5	70	113793

L mm	W mm	T mm	$\alpha$	B	$\gamma$	T06F
10.5	3.8	3.0	27	5	65	113794
10.5	4.1	3.0	27	5	65	113795
10.5	4.3	3.0	27	5	65	113796
10.5	4.8	3.0	27	5	65	113797
10.5	5.0	3.0	27	5	65	113798
10.5	5.3	3.0	27	5	65	113799
10.5	6.0	3.0	27	5	65	113800
10.5	7.0	3.0	27	5	65	113801



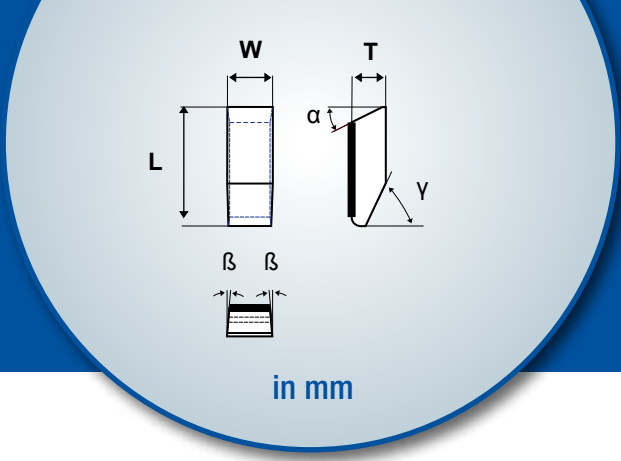

-  Pretinned saw tips
-  Lotbeschichtete Sägezähne
-  Dents de scie pré-brasées
-  Dentelli saldo-brasati per lame
-  Dientes de sierra con solda







in mm





L mm	W mm	T mm	$\alpha$	$\beta$	$\gamma$	T06F
10.5	4.0	3.5	27	5	60	119162
10.5	4.1	3.5	27	5	60	113802
10.5	4.3	3.5	27	5	60	113803
10.5	4.5	3.5	27	5	60	113804
10.5	5.0	3.5	27	5	60	116571
10.5	5.3	3.5	27	5	60	113805
10.5	5.5	3.5	27	5	60	117072
10.5	5.8	3.5	27	5	60	113806
10.5	6.0	3.5	27	5	60	119161
10.5	6.5	3.5	27	5	60	113807





L mm	W mm	T mm	$\alpha$	$\beta$	$\gamma$	T06F	T08MF
13.0	3.8	4.0	30	5	60		116279
13.0	4.9	4.0	30	5	60		119252
13.0	5.7	4.0	30	5	60		120390
13.0	5.8	4.0	30	5	60	120221	120394
13.0	6.0	4.0	30	5	60		120387
13.0	6.5	4.0	30	5	60	120222	120386
13.0	7.0	4.0	30	5	60		121371





-  BrazeTec alloys and fluxes
-  Lot und Flussmittel
-  Alliages et flux de brasage
-  Leghe brasanti e disossidanti
-  Aleaciones y fundentes para soldadura fuerte









-  BrazeTec 49/Cu sandwich brazing alloy strip, on spool
-  BrazeTec 49/Cu Schichtlot, auf Spule
-  BrazeTec 49/Cu alliage de brasage „sandwich“ en bande, sur bobine
-  BrazeTec 49/Cu lega brasante nastro trimetallico, in bobina
-  BrazeTec 49/Cu cinta tipo sandwich para soldadura fuerte, en carretes





Part No.	W mm	T mm	weight kg	Features
122449	2.0	0.3	1.0 - 1.5	 Trifoil with Cu-interlayer  Kupfer-Zwischenschicht  Trois feuilles avec le Cu en couche intermédiaire  Trilamina con strato intermedio di rame  Con la lámina de Cu intermedia
122450	2.5	0.3	1.0 - 1.5	
122451	3.0	0.3	1.0 - 1.5	
122452	3.2	0.3	1.0 - 2.0	
122453	3.5	0.3	1.5 - 2.0	
122454	4.0	0.3	1.5 - 2.0	

-  BrazeTec 49/Cu plus sandwich brazing alloy strip, on spool
-  BrazeTec 49/Cu plus Schichtlot, auf Spule
-  BrazeTec 49/Cu plus alliage de brasage „sandwich“ en bande, sur bobine
-  BrazeTec 49/Cu plus lega brasante nastro trimetallico, in bobina
-  BrazeTec 49/Cu plus cinta tipo sandwich para soldadura fuerte, en carretes





Part No.	W mm	T mm	weight kg	Features
122455	4.0	0.3	1.5 - 2.0	 For an extra high shear strength, with a modified Cu-interlayer  Für starke Beanspruchung, mit modifizierter Kupfer-Zwischenschicht  Pour très forte résistance au cisaillement, avec une liaison Cu entre couche modifiée  Con resistenza al taglio potenziata, con strato intermedio migliorato di rame  Para fuerte resistencia extra a cizallamiento, con la lámina de Cu intermedia modificada

-  BrazeTec 49/Cu13 sandwich brazing alloy strip for special applications, in coils
-  BrazeTec 49/Cu13 Lot für Sonderanwendungen, im Bunde
-  BrazeTec 49/Cu13 alliage de brasage „sandwich“ pour applications spéciales, en bande
-  BrazeTec 49/Cu13 lega brasante nastro trimetallico per applicazioni speciali, in bobina
-  BrazeTec 49/Cu13 cinta tipo sandwich para soldadura fuerte, en carretes

Part No.	W mm	T mm	weight kg
122456	40	0.8	1.0
122457	50	0.8	1.0
122458	60	0.8	1.0
122459	70	0.8	1.0

-  **Brazing alloys and fluxes**
-  **Lot und Flussmittel**
-  **Alliages et flux de brasage**
-  **Leghe brasanti e disossidanti**
-  **Aleaciones y fundentes para soldadura fuerte**



-  **BrazeTec h 285 brazing flux paste for automatic dispensing**
-  **BrazeTec h 285 Hartlot Flussmittel-Paste für Maschinendosierung**
-  **BrazeTec h 285 flux de brasage en pâte pour mise en oeuvre en automatique**
-  **BrazeTec h 285 disossidante in pasta per brasatura adatto per la distribuzione automatica**
-  **BrazeTec h 285 aleación en pasta con fundente para aplicar automáticamente**

Part No.	weight kg
115300	1.5

-  **BrazeTec special h brazing flux paste for manual applications**
-  **BrazeTec spezial h Hartlot Flussmittel-Paste für den Auftrag von Hand**
-  **BrazeTec spécial h flux de brasage en pâte pour utilisation manuelle**
-  **BrazeTec spezial h disossidante in pasta per brasatura per applicazione manuale**
-  **BrazeTec spezial h aleación en pasta con fundente para aplicar manualmente**





Part No.	weight kg
115301	1.0



**Tools cut better  
with TIGRA**









4

-  **Carbide for brazed tools**
-  **Hartmetall für gelötete Fräser**
-  **Plaquettes en carbure à braser**
-  **Metallo duro per frese saldobrasate**
-  **Metal duro para herramienta soldada**









-  Carbide for brazed tools - TIGRA carbide grades and their applications – Technical Data
-  Hartmetall für gelötete Fräser - TIGRA Hartmetallsorten und ihre Anwendungen – Technische Daten
-  Plaquettes en carbure à braser - Les nuances de carbures TIGRA et leurs applications – Caractéristiques techniques
-  Metallo duro per frese saldobrasate - I tipi di metallo duro TIGRA e le loro applicazioni – Dati tecnici
-  Metal duro para herramienta soldada - Calidades de metal duro TIGRA y sus aplicaciones – Datos técnicos





 TIGRA grade  TIGRA - Sorte  Nuance TIGRA  Tipo TIGRA  Calidad TIGRA	Binder Binder Liant Legante Composicion	Hardness Härte Dureté Durezza Durezza		Bending strength Biegebruchfestigkeit Resistance à la flexion Resistenza flessionale Resistencia a la flexión		Toughness Zähigkeit Ténacité Tenacità Tenacidad
		%	HV 10	HRA ± 0.2	N/mm <sup>2</sup>	psi
<b>T04F</b> ISO: K05 USA: C4	4.0	1750	92.8	2350	341.000	8.6
<b>T06M</b> ISO: K20 USA: C3 -	6.5	1400	90.3	2400	348.000	10.4
<b>T06MF</b> ISO: K20 USA: C2	6.5	1600	92.0	2500	363.000	9.9
<b>T08MF</b> ISO: K30 USA: C2	8.5	1470	90.9	2700	392.000	10.3
<b>T10MG</b> ISO: K10-K40 USA: C3 +	10.0	1650	92.3	3600	522.000	9.4
<b>TL15*</b>	13.5	1450	90.7	3800	551.000	10.5
<b>TL20*</b>	20.0	1400	90.3	3800	551.000	12.0

\* Special binder - Spezialbinder - Liant special - Legante speciale - Composicion especial





 TIGRA grade  TIGRA - Sorte  Nuance TIGRA  Tipo TIGRA  Calidad TIGRA	HDF	MDF	Chipboard Spanplatte Panneaux de particule Truciolare Panel de aglomerado	Hardwood Hartholz Bois dur Legno duro Madera dura	Softwood Weichholz Bois tendre Legno tenero Madera blanda
<b>T04F</b>	0	+	++	++	+
<b>T06M</b>	--	-	-	+	+
<b>T06MF</b>	-	0	+	++	++
<b>T08MF</b>	--	-	0	+	++
<b>T10MG</b>	-	0	+	++	++
<b>TL15</b>	-	-	0	++	+++
<b>TL20</b>	--	-	-	++	+++

					
+++	Excellent	Hervorragend	Parfaitement	Ottimo	Perfectamente
++	Very Good	Sehr gut	Très bien	Molto idoneo	Muy
+	Good	Gut	Bien	Idoneo	Algo
0	Acceptable	Akzeptabel	Acceptable	Accettabile	Acceptable
-	Not too good	Weniger gut	Moins bien	Meno idoneo	Mal
--	Poor	Schlecht geeignet	Mal adapté	Poco idoneo	Nada apropiado
---	Not suitable	Nicht geeignet	Pas utilisable	Non utilizzabile	No utilizable







-  Carbide for brazed tools - TIGRA carbide grades and their applications
-  Hartmetall für gelötete Fräser - TIGRA Hartmetallsorten und ihre Anwendungen
-  Plaquettes en carbure à braser - Les nuances de carbures TIGRA et leurs applications
-  Metallo duro per frese saldobrasate - I tipi di metallo duro TIGRA e le loro applicazioni
-  Metal duro para herramienta soldada - Calidades de metal duro TIGRA y sus aplicaciones

 TIGRA grade  TIGRA - Sorte  Nuance TIGRA  Tipo TIGRA  Calidad TIGRA	Main usage Hauptanwendung Principal usage Main uso Uso principal	
<b>T04F</b>	<b>Hardwood, board</b> <b>Hartholz, Plattenbearbeitung</b> <b>Bois durs, travail de panneaux</b> <b>Legno duro e lavorazione pannelli</b> <b>Maderas duras, panel</b>	
<b>T06M</b>	<b>Dry tool grinding</b> <b>Schärfen ohne Kühlmittel</b> <b>Affutage sans refroidissement</b> <b>Levigatura senza liquido refrigerante</b> <b>Perfilado sin refrigerante</b>	
<b>T06MF</b>	<b>Universal grade</b> <b>Universalsorte</b> <b>Nuance universelle</b> <b>Metallo duro universale</b> <b>Calidad universal</b>	
<b>T08MF</b>	<b>Softwood with knots</b> <b>Weichholz mit Astlöchern</b> <b>Bois moux avec noeuds</b> <b>Legno tenero con rami</b> <b>Madera blanda con nudos</b>	
<b>T10MG</b>	<b>Wood, large angles</b> <b>Holz, große Spanwinkel</b> <b>Travail avec angle de coupe élevé</b> <b>Legno, grandi angoli</b> <b>Desprendimiento pronunciado</b>	
<b>TL15 /TL 20</b>	<b>Micrograin - Softwood with knots</b> <b>Micrograin - Weichholz mit Astlöchern</b> <b>Micrograin - Bois moux avec noeuds</b> <b>Micrograin - Legno tenero con rami</b> <b>Micrograin - Madera blanda con nudos</b>	

-  Carbide for brazed tools - TIGRA carbide grades and their applications
-  Hartmetall für gelötete Fräser - TIGRA Hartmetallsorten und ihre Anwendungen
-  Plaquettes en carbure à braser - Les nuances de carbures TIGRA et leurs applications
-  Metallo duro per frese saldobrasate - I tipi di metallo duro TIGRA e le loro applicazioni
-  Metal duro para herramienta soldada - Calidades de metal duro TIGRA y sus aplicaciones

	<ul style="list-style-type: none"> <li> Carbide strips for brazed cutters</li> <li> Hartmetallplatten zur Fräserbestückung</li> <li> Plaquettes en carbure à braser</li> <li> Placchette in metallo duro per frese</li> <li> Placas de metal duro para equipar fresas</li> </ul>	<b>95-99</b>
	<ul style="list-style-type: none"> <li> Carbide tips for brazed cutters</li> <li> Formplatten zum Löten</li> <li> Plaquettes en carbure à braser</li> <li> Placchette per frese saldobrasate</li> <li> Placas para herramientas soldadas</li> </ul>	<b>100-101</b>
	<ul style="list-style-type: none"> <li> Carbide tips for router bits</li> <li> HM-Rohlinge für Oberfräser</li> <li> Ebauches pour mèches à défoncer</li> <li> Placchette sagomate per punte</li> <li> Placas de metal duro para equipar fresas</li> </ul>	<b>102</b>
	<ul style="list-style-type: none"> <li> Drill bits</li> <li> Zylinderkopfbohrer</li> <li> Mèches à façonner</li> <li> Punta per cerniere</li> <li> Brocas estrella</li> </ul>	<b>103-104</b>
	<ul style="list-style-type: none"> <li> Finger joint cutters</li> <li> Minizinkenfräser</li> <li> Fraises mini-aboutages</li> <li> Frese per giunzioni</li> <li> Fresas para ensamblar</li> </ul>	<b>104</b>
	<ul style="list-style-type: none"> <li> Tips for T.C.T. knives</li> <li> Rohlinge für HW-bestückte Messer</li> <li> Plaquettes pour fabriquer des fers rapportées carbure</li> <li> Placchette per fabricare coltelli riportati HW</li> <li> Placas para equipar cuchillas con metal duro</li> </ul>	<b>105</b>
	<ul style="list-style-type: none"> <li> Tips for multicut planers</li> <li> Zähne für Vielzahnfräser</li> <li> Dents spéciales</li> <li> Dentelli per frese multitaglienti</li> <li> Dientes para fresas multicorte</li> </ul>	<b>105</b>
	<ul style="list-style-type: none"> <li> Tips for drill bits</li> <li> Bohrspitzen</li> <li> Ebauches pour mèches</li> <li> Cuspidi</li> <li> Punta de broca</li> </ul>	<b>106</b>
	<ul style="list-style-type: none"> <li> TIGRAlloy - Bars for brazed cutters</li> <li> TIGRAlloy - Fräserplatten</li> <li> TIGRAlloy - Plaquettes à braser</li> <li> TIGRAlloy - Placchette per frese</li> <li> TIGRAlloy - Placas para equipar fresas</li> </ul>	<b>107-108</b>

-  Carbide strips for brazed cutters
-  Hartmetallplatten zur Fräserbestückung
-  Plaquettes en carbure à braser
-  Placchette in metallo duro per frese
-  Placas de metal duro para equipar fresas







T = 2-4 mm

L mm	W mm	T mm	T04F	T06MF	T08MF	T10MG
310	2	2				110300
310	4	2	100307	121839	054306	054405
310	5	2	100308	112933	105994	100549
310	6	2	100309	039888	031189	029130
310	8	2	101107	039889	031190	029131
310	10	2	100710	100785	031191	029132
310	12	2	100709	039891	031192	029133
310	14	2	101637	039892	031193	029136
310	15	2	108730	112935	114830	054311
310	16	2	108731	039893	031194	029138
310	18	2	108732	039894	031195	029139
310	20	2	055678	039895	031196	029140
310	22	2	108737	100792	050324	038192
310	25	2	055679	039896	031197	029141
310	30	2	055680	039897	031198	031186
310	3	3				110301
310	5	3	121840	112934	035891	054598
310	6	3	100310	039898	024509	024511
310	8	3	100311	039899	024513	024515
310	10	3	101638	039900	024517	024519
310	12	3	100619	039901	024521	024523
310	13	3	121841	121842	121843	041839
310	14	3	108738	039902	024525	024527
310	15	3	100312	100798	035892	041072
310	16	3	105249	039903	024529	024531
310	18	3	108739	039904	024533	024535
310	20	3	100313	039905	024537	024539
310	25	3	108740	039906	024541	024543
310	30	3	108741	039907	024545	024547
310	4	4				110302
310	8	4	100626	039909	024564	024566
310	10	4	101106	039910	024568	024570
310	12	4	100625	039911	024572	024574
310	14	4	102820	039912	024576	024578
310	15	4	100315	102784	040305	103213
310	16	4	100621	037636	024580	024582
310	18	4	100316	037637	024584	024586
310	20	4	101729	039913	024588	024590
310	22	4	100317	102883	103194	047082
310	25	4	100318	039914	024592	024594
310	28	4	106131	103181	103196	103214
310	30	4	105525	039915	024596	024598
310	35	4	108742	004348	051785	051786

Special executions, other tungsten carbide grades and further dimensions upon request.  
 Sonderausfertigungen, andere Hartmetallsorten und verschiedene Abmessungen auf Anfrage.  
 Exécutions spéciales, d'autres nuances de carbure et d'autres dimensions sur demande.  
 Esecuzioni speciali, altri tipi ed ulteriori dimensioni su richiesta.  
 Ejecuciones especiales, otras calidades y otras dimensiones a petición.



-  Carbide strips for brazed cutters
-  Hartmetallplatten zur Fräserbestückung
-  Plaquettes en carbure à braser
-  Placchette in metallo duro per frese
-  Placas de metal duro para equipar fresas







T = 5-6 mm

L mm	W mm	T mm	T04F	T06MF	T08MF	T10MG
310	5	5				110303
310	8	5	108743	039917	024625	024627
310	10	5	108768	039918	024629	024631
310	12	5	100319	039919	024633	024635
310	14	5	102229	039920	024637	024639
310	15	5	100627	103185	103205	039582
310	16	5	108744	039921	024641	024643
310	18	5	100321	039922	024645	024647
310	20	5	100322	039923	024649	024651
310	25	5	100323	039924	024653	024655
310	30	5	108745	039925	024657	024659
310	35	5	108746	103187	051787	051788
170	40	5	108747	024715	113381	050106
310	10	6		024677		024680
310	16	6		112936		024692
310	20	6		024697		024700
310	25	6		024701		024704
310	30	6		024705		024708

Special executions, other tungsten carbide grades and further dimensions upon request.  
 Sonderausfertigungen, andere Hartmetallsorten und verschiedene Abmessungen auf Anfrage.  
 Exécutions spéciales, d'autres nuances de carbure et d'autres dimensions sur demande.  
 Esecuzioni speciali, altri tipi ed ulteriori dimensioni su richiesta.  
 Ejecuciones especiales, otros calidades y otras dimensiones a petición.





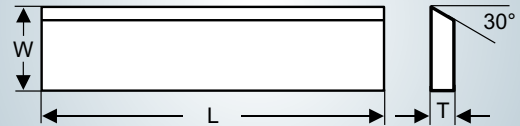

-  Carbide strips for brazed cutters
-  Hartmetallplatten zur Fräserbestückung
-  Plaquettes en carbure à braser
-  Placchette in metallo duro per frese
-  Placas de metal duro para equipar fresas



L mm	W mm	T mm	T04F	T06MF	T08MF	T10MG
310	8	3	108748	039927	024723	024725
310	10	3	108749	039928	024727	024729
310	12	3	108750	039929	024731	024733
310	14	3	108752	039930	024735	024737
310	15	3	108753	115073	038985	041080
310	16	3	108754	039931	024739	024741
310	18	3	108755	039932	024743	024745
310	20	3	108756	039933	024747	024749
310	25	3	108757	039934	024751	024753
310	30	3	108758	039935	024755	024757
310	8	4	108759	039937	024763	024765
310	10	4	108760	039938	024767	024769
310	12	4	108761	039939	024771	024773
310	14	4	108762	039940	024775	024777
310	15	4	108763	039459	049252	041081
310	16	4	108703	039941	024779	024781
310	18	4	108764	039942	024783	024785
310	20	4	102884	039943	024787	024789
310	22	4	102885	035925	049253	041082
310	25	4	102886	039944	024791	024793
310	28	4	102887	035926	049254	041083
310	30	4	108765	039945	024795	024797
310	35	4	108766	100275	051791	041084
310	8	5	108767	039947	024803	024805
310	10	5	108769	039948	024807	024809
310	12	5	108771	039949	024811	024813
310	14	5	108772	039950	024815	024817
310	15	5	108773	103186	103206	103218
310	16	5	108704	039951	024819	024821
310	18	5	108774	039952	024823	024825
310	20	5	108705	039953	024827	024829
310	25	5	108706	039954	024831	024833
310	30	5	108707	039955	024835	024837
310	35	5	108775	100843	051792	051793
170	40	5	115072	025208	029625	029264
310	10	6		024846	024847	024849
310	12	6		039959	024851	024853
310	16	6		039961	024859	024861
310	20	6		039963	024867	024869
310	25	6		039964	024871	024873
310	30	6		039965	024875	024877

Special executions, other tungsten carbide grades and further dimensions upon request.  
 Sonderausfertigungen, andere Hartmetallsorten und verschiedene Abmessungen auf Anfrage.  
 Exécutions spéciales, d'autres nuances de carbure et d'autres dimensions sur demande.  
 Esecuzioni speciali, altri tipi ed ulteriori dimensioni su richiesta.  
 Ejecuciones especiales, otras calidades y otras dimensiones a petición.





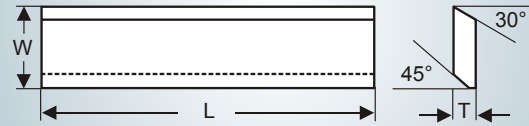

-  Carbide strips for brazed cutters
-  Hartmetallplatten zur Fräserbestückung
-  Plaquettes en carbure à braser
-  Placchette in metallo duro per frese
-  Placas de metal duro para equipar fresas



L mm	W mm	T mm	T04F	T06MF	T08MF	T10MG
310	8	3	108777	039967	024883	024885
310	10	3	108778	100860	024887	024889
310	12	3	108779	039969	024891	024893
310	14	3	108780	039970	024895	024897
310	15	3	108781	103178		103222
310	16	3	108782	039971	024899	024901
310	18	3	108783	039972	024903	024905
310	20	3	108784	039973	024907	024909
310	25	3	108785	039974	024911	024913
310	30	3	108786	039975	024915	024917
310	8	4	100629	039977	024929	024931
310	10	4	108787	039978	024933	024935
310	12	4	103853	039979	024937	024939
310	14	4	102230	039980	024941	024943
310	15	4	108788	103175	035893	050690
310	16	4	103854	039981	024945	024947
310	18	4	108789	039982	024949	024951
310	20	4	108790	039983	024953	024955
310	22	4	108791	102675	103195	103223
310	25	4	108792	100875	024957	024959
310	28	4	108793	102677	103198	101527
310	30	4	108794	039985	024961	024963
310	35	4	108797	100877	050600	051797
310	8	5	108798	039987	024976	024978
310	10	5	054402	039988	024980	024982
310	12	5	055663	039990	024984	024986
310	14	5	102563	039991	024988	024990
310	15	5	100628	100882	035894	035897
310	16	5	106180	039992	024992	024994
310	18	5	004371	039993	024996	024998
310	20	5	054231	039994	025000	025002
310	25	5	054439	039995	025004	025006
310	30	5	054677	039996	025008	025010
310	35	5	056072	054692	051798	051799
170	40	5	053297	100889	114831	039094
310	10	6	054403	039999	025021	025023
310	12	6	004372	040000	025025	025027
310	16	6	108799	040002	025033	025035
310	20	6	054323	040004	025041	025043
310	25	6	108800	040005	025045	025047
310	30	6	004375	040006	025049	025051

Special executions, other tungsten carbide grades and further dimensions upon request.  
 Sonderausfertigungen, andere Hartmetallsorten und verschiedene Abmessungen auf Anfrage.  
 Exécutions spéciales, d'autres nuances de carbure et d'autres dimensions sur demande.  
 Esecuzioni speciali, altri tipi ed ulteriori dimensioni su richiesta.  
 Ejecuciones especiales, otros calidades y otras dimensiones a petición.



-  Carbide strips for brazed cutters
-  Hartmetallplatten zur Fräserbestückung
-  Plaquettes en carbure à braser
-  Placchette in metallo duro per frese
-  Placas de metal duro para equipar fresas

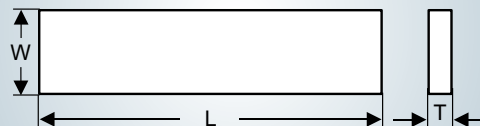





US style

Style	L	W	T	T06MF	T08MF	T06M	T10MG	TL15
	inch	inch	inch	C3	C2	C3-	C3+	
STB 310	6	5/16	3/32	025066	060188	062487	029145	060397
STB 312	6	3/8	3/32	025070	060189	062390	029149	037315
STB 316	6	1/2	3/32	025075	060190	062244	029154	038661
STB 320	6	5/8	3/32	025080	060191	062183	029159	060398
STB 324	6	3/4	3/32	025085	060371	062245	029164	060399
STB 328	6	7/8	3/32	025090	060192	062246	029169	037316
STB 332	6	1	3/32	025095	060193	062184	029174	037314
STB 336	6	1 1/8	3/32	025100	060194	062247	029179	060400
STB 340	6	1 1/4	3/32	025106	060195	062488	029184	037312
STB 344	6	1 3/8	3/32	060367	060368	062501	060369	060401
STB 348	6	1 1/2	3/32	025112	060196	062489	029190	037313
STB 410	6	5/16	1/8	025067	032651	062490	029146	029367
STB 412	6	3/8	1/8	025071	032621	061884	029150	029371
STB 416	6	1/2	1/8	025076	032622	061779	029155	029376
STB 420	6	5/8	1/8	025081	032623	061778	029160	029381
STB 424	6	3/4	1/8	025086	032624	061780	029165	029386
STB 428	6	7/8	1/8	025091	032625	061781	029170	029391
STB 432	6	1	1/8	025096	032626	061777	029175	029396
STB 436	6	1 1/8	1/8	025101	032627	061782	029180	029401
STB 440	6	1 1/4	1/8	025107	032628	062253	029185	029406
STB 444	6	1 3/8	1/8	025111	032629	062502	029189	031564
STB 448	6	1 1/2	1/8	025113	032630	061783	029191	029411
STB 510	6	5/16	5/32	025068	032631	062505	029147	029368
STB 512	6	3/8	5/32	025072	032632	062506	029151	029372
STB 516	6	1/2	5/32	025077	032633	062507	029156	029377
STB 520	6	5/8	5/32	025082	032634	062508	029161	029382
STB 524	6	3/4	5/32	025087	032635	062509	029166	029387
STB 528	6	7/8	5/32	025092	032636	062510	029171	029392
STB 532	6	1	5/32	025097	032637	062511	029176	029397
STB 536	6	1 1/8	5/32	025102	032638	062512	029181	029402
STB 540	6	1 1/4	5/32	025108	032639	062513	029186	029407
STB 544	6	1 3/8	5/32	060393	060391	062514	060395	060402
STB 548	6	1 1/2	5/32	025114	032640	062515	029192	029412
STB 610	6	5/16	3/16	025069	032641	062516	029148	029369
STB 612	6	3/8	3/16	025073	032642	062517	029152	029373
STB 616	6	1/2	3/16	025078	029663	062518	029157	029378
STB 620	6	5/8	3/16	025083	032643	062519	029162	029383
STB 624	6	3/4	3/16	025088	032644	062520	029167	029388
STB 628	6	7/8	3/16	025093	032645	062521	029172	029393
STB 632	6	1	3/16	025098	032646	062522	029177	029398
STB 636	6	1 1/8	3/16	025103	060197	062523	029182	060403
STB 640	6	1 1/4	3/16	025109	032647	062524	029187	029408
STB 644	6	1 3/8	3/16	060394	060392	062525	060396	060404
STB 648	6	1 1/2	3/16	025115	032648	062526	029193	029413

Special executions, other tungsten carbide grades and further dimensions upon request.  
 Sonderausfertigungen, andere Hartmetallsorten und verschiedene Abmessungen auf Anfrage.  
 Exécutions spéciales, d'autres nuances de carbure et d'autres dimensions sur demande.  
 Esecuzioni speciali, altri tipi ed ulteriori dimensioni su richiesta.  
 Ejecuciones especiales, otras calidades y otras dimensiones a petición.



-  Carbide tips for brazed cutters
-  Formplatten zum Lötten
-  Plaquettes en carbure à braser
-  Placchette per frese saldobrasate
-  Placas para herramientas soldadas

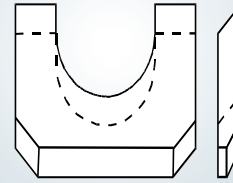

-  Quick delivery service
-  Schnelldienst
-  Service rapide
-  Servizio rapido
-  Entrega servicio rapido



#### Preforms for brazed cutters

Using preformed tips for your brazed cutters you will save the expensive roughing time and grinding wheel cost. TIGRA can supply almost any kind of preformed tip, according to the customer's drawing or DXF file. Small quantities for urgent special tools can be delivered from our quick delivery service within one week.

#### Formplatten für gelötete Fräser

Durch die Verwendung vorgeformter Hartmetallplatten sparen Sie teure Schruppzeiten und Kosten für die Schleifscheiben. TIGRA liefert nahezu jede vorgeformte Platte nach Kundenzeichnung oder DXF-Datei. Kleinserien für eilige Sonderwerkzeuge liefert unser Schnelldienst innerhalb von einer Woche.

#### Plaquettes préprofilées pour fraises brasées





Grâce à l'utilisation de plaquettes en carbure préprofilées, plus besoin de coûteuses opérations de dégrossissage ni des frais élevés pour les meules. TIGRA peut fournir pratiquement n'importe quelle plaquette préprofilée d'après le dessin du client ou un fichier DXF. Notre services d'urgence livre de petites séries pour les outils spéciaux urgents en une semaine.

#### Placchette per frese saldobrasate

Con l'uso delle placchette preformate risparmierete non solo la sgrossatura bensì anche i costi delle mole. TIGRA può fornire quasi ogni tipo di placchetta preformata a seconda delle Vostre richieste ed esigenze (documenti DXF; schizzi). Per ordini urgenti di piccole quantità riguardanti utensili particolari siamo in grado di fornirvi la merce nell'arco di una settimana.

#### Placas de molde para fresas soldadas

El empleo de placas de metal duro preformadas le permitirá ahorrarse la costosa fase de desbastado y reducir el consumo de muelas. TIGRA puede fabricar prácticamente cualquier tipo de placa preformada en base al plano o fichero DXF del cliente. Si necesitara una herramienta especial con urgencia, nuestro servicio rápido es capaz de fabricar un lote de pocas unidades en una semana.

-  Carbide tips for brazed cutters
-  Formplatten zum Löten
-  Plaquettes en carbure à braser
-  Placchette per frese saldobrasate
-  Placas para herramientas soldadas

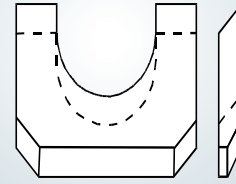

**Profile - Profil - Profil - Profilo - Perfil 1**





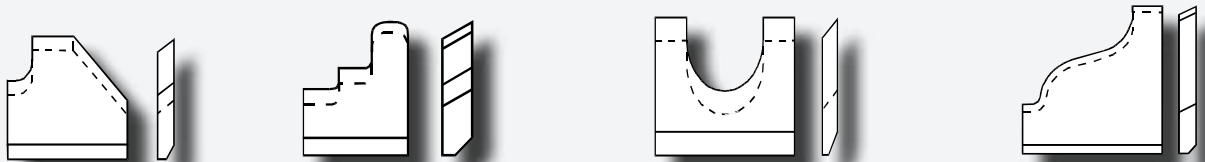

**Profile - Profil - Profil - Profilo - Perfil 2**

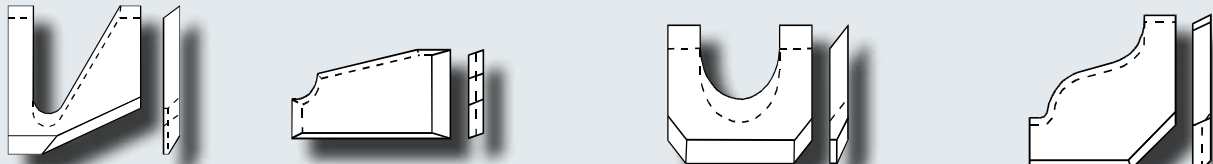







**Profile - Profil - Profil - Profilo - Perfil 3**

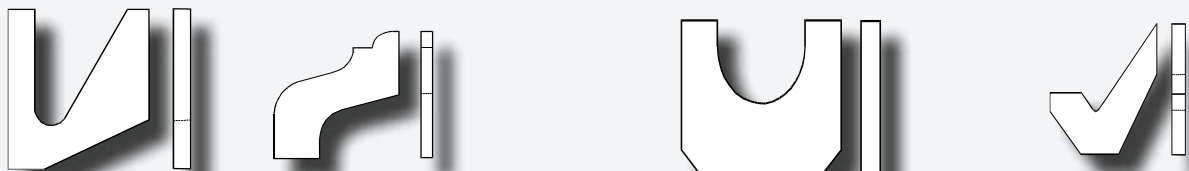





-  The profile groups 1, 2 and 3 are with chamfers in the profile and/or at the bottom.
-  Die Profilgruppen 1, 2 und 3 haben Fasen im Profil und/oder an der Anschlagkante.
-  Les groupes de profils 1, 2 et 3 ont des biseaux dans le profil et/ou au bord de butée.
-  I gruppi di profili 1, 2 e 3 sono provvisti di smussi nel profilo e/o nello spigolo di battuta.
-  Los grupos de perfil tienen 1, 2 y 3 tanto un perfil, como la base biselados.

**Profile - Profil - Profil - Profilo - Perfil 4**



-  Profile group 4 is without any chamfers and therefore less expensive!
-  Profilgruppe 4 hat keinerlei Fasen. Der Preis dafür ist deutlich günstiger!
-  Les groupes de profils 4 n'a pas de biseaux. Le prix de ce modèle est de ce fait bien plus avantageux!
-  Il gruppo di profili 4 non è provvisto di smussi ed ha pertanto un prezzo notevolmente inferiore!
-  El grupo de perfil 4 non tiene ningun bisel. El precio de este modelo sera muy ventajoso para vds!

-  Carbide tips for router bits
-  HM-Rohlinge für Oberfräser
-  Ebauches pour méches à défoncer
-  Placchette sagomate per punte
-  Placas de metal duro para equipar fresas



#### Preforms for router bits

Carbide tips for router bits are available preformed in almost any sizes or executions, as per customer's drawing or DXF file, also for small quantities. Your production cost for router bits will be reduced by saving the cost for cutting, wire cutting, roughing and diamond wheels. Small quantities for urgent special tools are supplied from our quick delivery service within only one week.

#### Platten für Oberfräser

Hartmetallplatten für Oberfräser sind vorgeformt in fast allen Größen und Ausführungen nach Kundenzeichnung oder DXF-Datei lieferbar, auch für Kleinserien. So sparen Sie auch bei der Herstellung von Oberfräsern die Kosten für das Trennen, Drahtschneiden oder Schruppen sowie Kosten für Schleifscheiben. Kleinserien für eilige Sonderwerkzeuge liefert unser Schnelldienst innerhalb von einer Woche.

#### Plaquettes pour défonceuse

Les plaquettes au carbure pour défonceuse peuvent être livrées préfaçonnées dans pratiquement toutes les tailles et exécutions d'après le dessin du client ou un fichier DXF, même en petites séries. Vous économisez ainsi les frais de tronçonnage, de meules abrasive même lors de la fabrication d'outil pour défonceuses. Notre service d'urgence livre de petites séries pour les outils spéciaux urgents en une semaine.

#### Placchette sagomate per punte









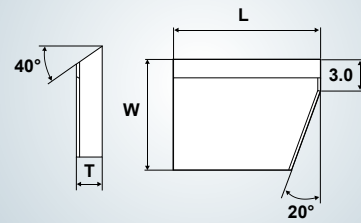

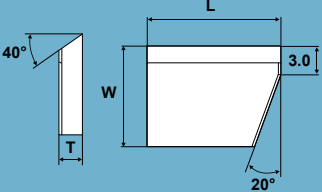

Le placchette sagomate per punte sono disponibili in quasi ogni misura secondo disegno o documento DXF, anche in quantità minime. Risparmiate i costi di tagli, sgrossatura e delle mole per la produzione delle punte. Per ordini urgenti di piccole quantità riguardanti utensili particolari siamo in grado di fornirvi la merce in una settimana.

#### Placas para fresas de cajeadora

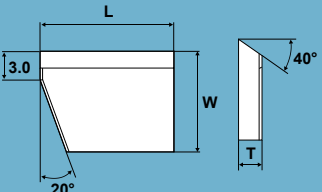
Podemos suministrar placas de metal duro preformadas para fresas de cajeadora de cualquier tamaño y modelo en base al plano o diseño en formato DXF del cliente, incluso lotes de volumen reducido. Se ahorrará así las operaciones de corte, electroerosión o debastado y podrá reducir el consumo de muelas. Si necesitara una herramienta especial con urgencia, nuestro servicio rápido es capaz de fabricar un lote de tamaño reducido en una semana.

-  Drill bits
-  Zylinderkopfbohrer
-  Mèches à façonner
-  Punte per cerniere
-  Brocas estrella







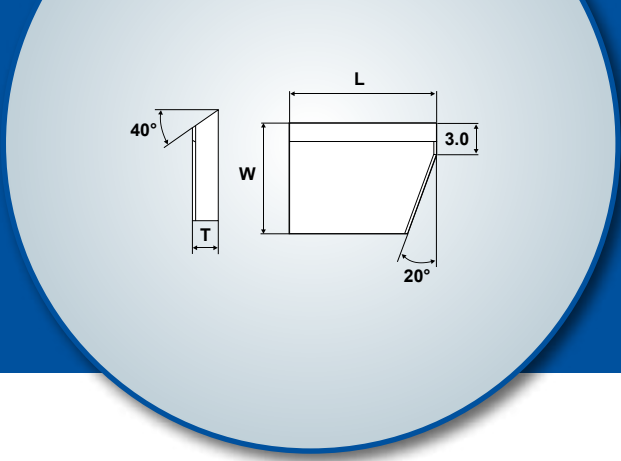

	diam	L mm	W mm	T mm	T06MF
 <ul style="list-style-type: none"> <li> left</li> <li> links</li> <li> gauche</li> <li> sinistra</li> <li> izquierda</li> </ul>	15.0	6.5	8.5	2.5	032657
	16.0	7.0	10.5	2.5	032658
	18.0	8.0	10.5	2.5	032659
	20.0	9.0	10.5	2.5	032660
	22.0	10.0	10.5	2.5	032661
	23.0	10.5	10.5	2.5	032662
	24.0	11.0	10.5	2.5	032663
	25.0	11.5	10.5	2.5	032664
	26.0	12.0	10.5	2.5	032665
	28.0	13.0	10.5	2.5	032666
	30.0	14.0	10.5	2.5	032667
	32.0	15.0	10.5	2.5	032668
	34.0	16.0	10.5	2.5	032669
	35.0	16.5	10.5	2.5	032670
	38.0	18.0	10.5	2.5	032671
	40.0	19.0	10.5	2.5	032672
	45.0	21.5	10.5	2.5	032151
50.0	24.0	10.5	2.5	032673	
55.0	26.5	10.5	2.5	032674	
60.0	29.0	10.5	2.5	032675	
 <ul style="list-style-type: none"> <li> right</li> <li> rechts</li> <li> droite</li> <li> destra</li> <li> derecha</li> </ul>	15.0	6.5	8.5	2.5	032676
	16.0	7.0	10.5	2.5	032677
	18.0	8.0	10.5	2.5	032678
	20.0	9.0	10.5	2.5	032679
	22.0	10.0	10.5	2.5	032680
	23.0	10.5	10.5	2.5	032681
	24.0	11.0	10.5	2.5	032682
	25.0	11.5	10.5	2.5	032683
	26.0	12.0	10.5	2.5	032684
	28.0	13.0	10.5	2.5	032685
	30.0	14.0	10.5	2.5	032686
	32.0	15.0	10.5	2.5	032687
	34.0	16.0	10.5	2.5	032688
	35.0	16.5	10.5	2.5	032689
	38.0	18.0	10.5	2.5	032690
	40.0	19.0	10.5	2.5	032691
	45.0	21.5	10.5	2.5	032692
50.0	24.0	10.5	2.5	032693	
55.0	26.5	10.5	2.5	032694	
60.0	29.0	10.5	2.5	032695	

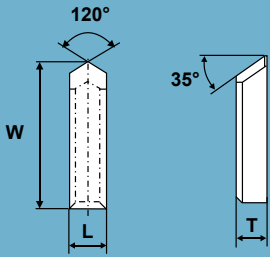
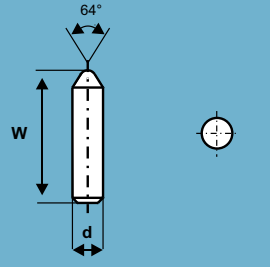
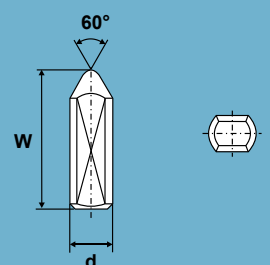

-  Drill bits
-  Zylinderkopfbohrer
-  Mèches à façonner
-  Punte per cerniere
-  Brocas estrella



	d	L mm	W mm	T mm	T06MF
		3.0	12.0	2.5	032702
		4.0	13.0	2.5	032703
	3.0		13.0		055341
	4.0		13.0		032704

-  Finger joint cutters
-  Minizinkenfräser
-  Fraises mini-aboutages
-  Frese per giunzioni
-  Fresas para ensamblar

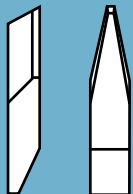
	L mm	W mm	T mm	T08MF	T10MG
	4.5	28.0	4.1	029105	041997
	5.0	28.0	4.1	107858	107859

 Tips for T.C.T. knives

 Rohlinge für HW-bestückte Messer

 Plaquettes pour fabriquer des fers rapportés carbure

 Placchette per fabricare coltelli riportati HW

 Placas para equipar cuchillas con metal duro

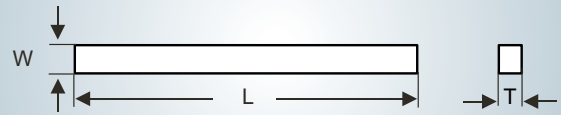

L mm	W mm	T mm	T10MF
1052	11.2	1.3	114832
1052	11.6	1.6	107063
652	16	2	114834
652	22	2	114835
652	27	2	114836
652	32	2	114837
652	16	2.3	114838
652	22	2.3	114839
652	27	2.3	114840
652	32	2.3	114841

 Tips for multicut planers

 Zähne für Vielzahnfräser

 Dents spéciales

 Dentelli per frese multitaglienti

 Dientes para fresas multicorte

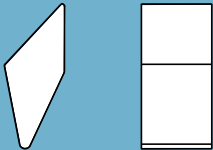
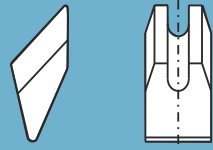
	L mm	W mm	T mm	T10MG
	12.8	6.2	5.3	029090
	12.8	8.2	5.3	114884
	12.8	6.2	5.3	112940

🇬🇧 Tips for drill bits

🇩🇪 Bohrspitzen

🇫🇷 Ebauches pour mèches



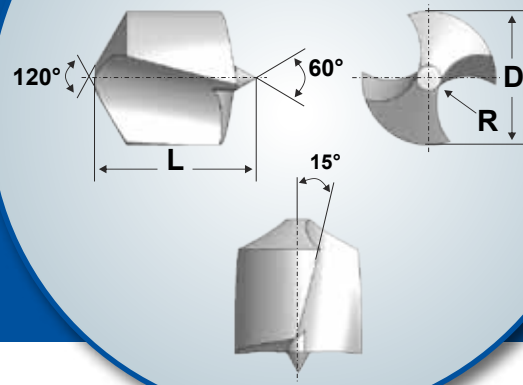

🇮🇹 Cuspidi

🇪🇸 Punta de broca



🇬🇧 Tips for drill bits - dowel drill 🇩🇪 Bohrspitzen - Dübelbohrer 🇫🇷 Ebauches pour mèches - trou borgne 🇮🇹 Cuspidi - fori ciechi 🇪🇸 Punta de broca - ciega	for Ø	D	L	R	Grade Sorte Nuance Tipo Calidad	right rechts droite destra derecha	left links gauche sinistra izquierda
	mm	mm	mm	mm			
<p>right rechts droite destra derecha</p>	4	4.6	7.3	1.15	T08MF	122404	122419
	5	5.6	7.9	1.8	T08MF	122405	122420
	6	6.6	8.2	2.2	T08MF	122406	122421
	7	7.6	8.9	2.7	T08MF	122407	122422
	8	8.6	9.9	3.2	T08MF	122408	122423
	10	10.6	12.6	3.7	T08MF	122409	122424
	12	12.6	13.6	4.3	T08MF	122410	122425
	15	15.6	16.4	5.0	T08MF	122411	122426
	16	16.6	17.2	5.5	T08MF	122412	122427

🇬🇧 Tips for drill bits - thru hole 🇩🇪 Bohrspitzen - Durchgangsbohrer 🇫🇷 Ebauches pour mèches - trou débouchant 🇮🇹 Cuspidi - fori passanti 🇪🇸 Punta de broca - pasante	for Ø	D	L	R	Grade Sorte Nuance Tipo Calidad	right rechts droite destra derecha	left links gauche sinistra izquierda
	mm	mm	mm	mm			
<p>right rechts droite destra derecha</p>	5	5.6	10.8	2.0	T08MF	122413	122428
	6	6.6	11.8	2.5	T08MF	122414	122429
	7	7.6	13.6	2.75	T08MF	122415	122430
	8	8.6	14.5	3.0	T08MF	122416	122431
	10	10.6	19.4	4.2	T08MF	122417	122432
	12	12.6	22.5	4.9	T08MF	122418	122433

-  TIGRAlloy - Bars for brazed cutters
-  TIGRAlloy - Fräserplatten
-  TIGRAlloy - Plaquettes à braser
-  TIGRAlloy - Placchette per frese
-  TIGRAlloy - Placas para equipar fresas



TIGRAlloy  
mm

L mm	W mm	T mm	TIGRAlloy
165	10	3	050137
165	12	3	050138
165	15	3	050185
165	16	3	050186
165	18	3	050187
165	20	3	050188
165	25	3	050189
165	10	4	050190
165	12	4	050191
165	15	4	050192
165	16	4	050193
165	18	4	050194
165	20	4	050195
165	25	4	050196
165	30	4	050197
165	10	5	050199
165	12	5	050200
165	15	5	050201
165	16	5	050202
165	18	5	050203
165	20	5	050204
165	25	5	050205
165	30	5	050206
165	35	5	050207
165	40	5	050209

 TIGRAlloy - Bars for brazed cutters

 TIGRAlloy - Fräserplatten

 TIGRAlloy - Plaquettes à braser

 TIGRAlloy - Placchette per frese

 TIGRAlloy - Placas para equipar fresas

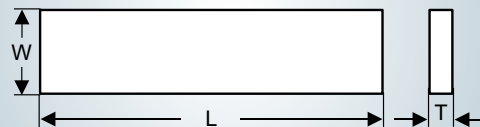

TIGRAlloy  
inch

Style	L inch	W inch	T inch	TIGRAlloy
STB 312	6	3/8	3/32	046284
STB 316	6	1/2	3/32	046290
STB 320	6	5/8	3/32	046291
STB 324	6	3/4	3/32	046292
STB 328	6	7/8	3/32	046293
STB 332	6	1	3/32	046294
STB 336	6	1 1/8	3/32	046352
STB 340	6	1 1/4	3/32	046353
STB 348	6	1 1/2	3/32	046354
STB 412	6	3/8	1/8	046295
STB 416	6	1/2	1/8	046296
STB 420	6	5/8	1/8	046297
STB 424	6	3/4	1/8	046298
STB 428	6	7/8	1/8	046299
STB 432	6	1	1/8	046300
STB 436	6	1 1/8	1/8	046454
STB 440	6	1 1/4	1/8	046301
STB 448	6	1 1/2	1/8	046302
STB 510	6	5/16	5/32	046457
STB 512	6	3/8	5/32	046459
STB 516	6	1/2	5/32	046460
STB 520	6	5/8	5/32	046461
STB 524	6	3/4	5/32	046462
STB 528	6	7/8	5/32	046463
STB 532	6	1	5/32	046464
STB 536	6	1 1/8	5/32	046465
STB 540	6	1 1/4	5/32	046466
STB 612	6	3/8	3/16	046469
STB 616	6	1/2	3/16	046470
STB 620	6	5/8	3/16	046471
STB 624	6	3/4	3/16	046472
STB 628	6	7/8	3/16	046473
STB 632	6	1	3/16	050603
STB 636	6	1 1/8	3/16	046474
STB 640	6	1 1/4	3/16	046475
STB 648	6	1 1/2	3/16	046476





Description of TIGRAlloy please see page 63.  
 TIGRAlloy-Beschreibung siehe Seite 63.  
 Description de TIGRAlloy s'il vous plaît voir la page 63.  
 Descrizione del TIGRAlloy si prega di vedere a pagina 63.  
 Descripción de TIGRAlloy por favor consulte la página 63.





**Tools cut better  
with TIGRA**







-  **Planer knives**
-  **Hobelmesser**
-  **Couteaux à raboter**
-  **Coltelli da pialla**
-  **Cuchillas para cepillar**



























-  **Planer knives**
-  **Hobelmesser**
-  **Couteaux à raboter**
-  **Coltelli da pialla**
-  **Cuchillas para cepillar**

	<ul style="list-style-type: none"> <li> Reversible knives for portable planers</li> <li> Wendeschneidplatten für Handhobel</li> <li> Plaquettes pour rabots électro portatifs</li> <li> Coltelli piallatrici portatili</li> <li> Cuchillas para acepilladoras electricas</li> </ul>	<b>118</b>
	<ul style="list-style-type: none"> <li> Planer knives for system Tersa</li> <li> Hobelmesser für System Tersa</li> <li> Couteaux à raboter pour système Tersa</li> <li> Coltelli da pialla per sistema Tersa</li> <li> Cuchillas para cepillar para sistema Tersa</li> </ul>	<b>119-120</b>
	<ul style="list-style-type: none"> <li> Planer knives for system Centrolock</li> <li> Hobelmesser für System Centrolock</li> <li> Couteaux à raboter pour système Centrolock</li> <li> Coltelli da pialla per sistema Centrolock</li> <li> Cuchillas para cepillar para sistema Centrolock</li> </ul>	<b>121</b>
	<ul style="list-style-type: none"> <li> Planer knives for system Terminus</li> <li> Hobelmesser für System Terminus</li> <li> Couteaux à raboter pour système Terminus</li> <li> Coltelli da pialla per sistema Terminus</li> <li> Cuchillas para cepillar para sistema Terminus</li> </ul>	<b>122</b>
	<ul style="list-style-type: none"> <li> Planer knives for system Centrofix / Centrostar / Quickfix</li> <li> Hobelmesser für System Centrofix / Centrostar / Quickfix</li> <li> Couteaux à raboter pour système Centrofix / Centrostar / Quickfix</li> <li> Coltelli da pialla per sistema Centrofix / Centrostar / Quickfix</li> <li> Cuchillas para cepillar para sistema Centrofix / Centrostar / Quickfix</li> </ul>	<b>123</b>
	<ul style="list-style-type: none"> <li> Planer knives for system Variplan</li> <li> Hobelmesser für System Variplan</li> <li> Couteaux à raboter pour système Variplan</li> <li> Coltelli da pialla per sistema Variplan</li> <li> Cuchillas para cepillar para sistema Variplan</li> </ul>	<b>124</b>
	<ul style="list-style-type: none"> <li> Planer knives for system Sinus</li> <li> Hobelmesser für System Sinus</li> <li> Couteaux à raboter pour système Sinus</li> <li> Coltelli da pialla per sistema Sinus</li> <li> Cuchillas para cepillar para Sinus</li> </ul>	<b>125</b>
	<ul style="list-style-type: none"> <li> Planer knives for system Enshin</li> <li> Hobelmesser für System Enshin</li> <li> Couteaux à raboter pour système Enshin</li> <li> Coltelli da pialla per sistema Enshin</li> <li> Cuchillas para cepillar para sistema Enshin</li> </ul>	<b>126</b>
	<ul style="list-style-type: none"> <li> Planer knives for system Bulldozer</li> <li> Hobelmesser für System Bulldozer</li> <li> Couteaux à raboter pour système Bulldozer</li> <li> Coltelli da pialla per sistema Bulldozer</li> <li> Cuchillas para cepillar para sistema Bulldozer</li> </ul>	<b>127</b>
	<ul style="list-style-type: none"> <li> HSS / High Performance Steel / Matrix planer knives</li> <li> HSS / High Performance Steel / Matrix-Hobelmesser</li> <li> Fers de raboteuse HSS / High Performance Steel / Matrix</li> <li> Coltelli da pialla HSS / High Performance Steel / Matrix</li> <li> Cuchillas en HSS / High Performance Steel / Matrix</li> </ul>	<b>128-130</b>
	<ul style="list-style-type: none"> <li> T.C.T. planer knives</li> <li> HM-bestückte Hobelmesser</li> <li> Couteaux à mise rapportée carbure</li> <li> Coltelli da pialla con metallo duro riportato</li> <li> Cuchillas con metal duro</li> </ul>	<b>131</b>
	<ul style="list-style-type: none"> <li> Solid carbide planer knives</li> <li> Vollhartmetall Hobelmesser</li> <li> Couteaux à raboter au carbure massif</li> <li> Coltelli da pialla in HM integrale</li> <li> Cuchillas metal duro integral</li> </ul>	<b>132</b>





-  **Planer knives - TIGRA materials and their applications**
-  **Hobelmesser - TIGRA Materialien und ihre Anwendungen**
-  **Couteaux à raboter - Les matériaux TIGRA et leurs applications**
-  **Coltelli da pialla - I materiali TIGRA e le loro applicazioni**
-  **Cuchillas para cepillar - Los materiales TIGRA y sus aplicaciones**

 System planer knives  Systemhobelmesser  Couteaux à raboter pour système  Coltelli da pialla per sistema  Cuchillas para cepillar para sistema	Lifetime Standzeit Durée de vie Durata Vida	Price Preis Prix Prezzo Precio	Ease of use Einfache Anwendung Simple d'utilisation Semplice uso Simple aplicación	Overall Gesamturteil Générale Giudizio finale En general veredicto
<b>HSS (Black Oxide)</b>	+	+++	+++	+++
<b>HSS (Black Oxide) 18%</b>	++	++	++	++
<b>HSS (Black Oxide) M42</b>	++	+	++	++
<b>High Performance Steel</b>	0	+++	++	++
<b>Tungsten carbide</b>	+++	0	0	++





 Thin planer knives  Streifenhobelmesser  Couteaux à raboter  Coltelli da pialla  Cuchillas para cepillar	Lifetime Standzeit Durée de vie Durata Vida	Price Preis Prix Prezzo Precio	Ease of use Einfache Anwendung Simple d'utilisation Semplice uso Simple aplicación	Overall Gesamturteil Générale Giudizio finale En general veredicto
<b>HSS</b>	+	++	+++	+++
<b>HSS 18%</b>	++	+	++	++
<b>High Performance Steel</b>	0	+++	++	++
<b>T.C.T.</b>	+++	+	0	++
<b>Solid carbide</b>	+++	0	+	+++
<b>Matrix - coating technology</b>	+++	+	++	+++

 System planer knives  Systemhobelmesser  Couteaux à raboter pour système  Coltelli da pialla per sistema  Cuchillas para cepillar para sistema	Main usage Hauptanwendung Principal usage Main uso Usó principal
<b>HSS (Black Oxide)</b>	Universal grade, best price/performance Universalsorte, bestes Preis-Leistungsverhältnis Nuance universelle, mieux rapport qualité-prix Qualità universale, miglior rapporto qualità/prezzo Calidad Universal , Relacion calidad/precio optimo
<b>HSS (Black Oxide) 18%</b>	Hard and abrasive applications Harte und abrasive Anwendungen Applications dans des bois abrasifs et durs Applicazioni per mat. duri ed abrasivi Aplicaciones para maeriales duros y abrasivos



-  **Planer knives - TIGRA materials and their applications**
-  **Hobelmesser - TIGRA Materialien und ihre Anwendungen**
-  **Couteaux à raboter - Les matériaux TIGRA et leurs applications**
-  **Coltelli da pialla - I materiali TIGRA e le loro applicazioni**
-  **Cuchillas para cepillar - Los materiales TIGRA y sus aplicaciones**

<ul style="list-style-type: none"> <li> System planer knives</li> <li> Systemhobelmesser</li> <li> Couteaux à raboter pour système</li> <li> Coltelli da pialla per sistema</li> <li> Cuchillas para cepillar para sistema</li> </ul>	<p>Main usage Hauptanwendung Principal usage Main uso Uso principal</p>
<p><b>HSS (Black Oxide) M42</b></p>	<p>Abrasive applications Abrasive Anwendungen Applications dans des bois abrasifs Applicazioni abrasivi Aplicaciones para materiales aprasivos</p>
<p><b>High Performance Steel</b></p>	<p>Softwood, low price demand Weichholz, niedriger Preis Bois moux, prix bas Legni teneri, prezzo ridotto Madera tenaz, precio economico</p>
<p><b>Tungsten carbide</b></p>	<p>High lifetime demands Hohe Standzeitansprüche Recours à une haute tenue de coupe Per richiesta di alta dura Para aplicaciones de alto rendimiento</p>
<ul style="list-style-type: none"> <li> Thin planer knives</li> <li> Streifenhobelmesser</li> <li> Couteaux à raboter</li> <li> Coltelli da pialla</li> <li> Cuchillas para cepillar</li> </ul>	<p>Main usage Hauptanwendung Principal usage Main uso Uso principal</p>
<p><b>HSS</b></p>	<p>Universal grade for soft and hardwood Universalsorte für Weich- und Hartholz Nuance universelle pour des bois moux et durs Qualità universale per legni duri e teneri Calidad universal para maderas duras y tenaces</p>
<p><b>HSS 18%</b></p>	<p>Abrasive and very hard woods Abrasive und sehr harte Hölzer Des bois abrasifs et très durs Legni abrasivi e molto duri Maderas abrasivas y muy duras</p>
<p><b>High Performance Steel</b></p>	<p>Softwood, low price demand Weichholz, niedriger Preis Bois moux, prix bas Legni teneri, prezzo ridotto Madera tenaz, precio economico</p>
<p><b>T.C.T.</b></p>	<p>Higher lifetime demands Höhere Standzeitansprüche Recours à une tenue de coupe plus haute Per richiesta di alta dura Para aplicaciones de alto rendimiento</p>
<p><b>Solid carbide</b></p>	<p>Highest lifetime demands Höchste Standzeitansprüche Recours à une tenue de coupe très haute Per richiesta di massima durata Para aplicaciones de maxima dureza</p>
<p><b>Matrix - coating technology</b></p>	<p>Very long lifetime with multiple resharpening Sehr lange Standwege bei bester Nachschärfbarkeit Très longue durée de vie et rectification parfaite Lunghissima durata e buonissima riaffilatura Vida útil muy prolongada y excelente rectificabilidad</p>

-  Knives for planing systems
-  Messer für Hobelsysteme
-  Couteaux pour outils à raboter
-  Coltelli per sistemi da pialla
-  Cuchillas para cepillar



hard      soft      hard  
 hart      weich      hart  
 dur      souple      dur  
 duro      morbido      duro  
 duro      macio      duro

 **Optimized distribution of hardness**

The unique manufacturing process maneuvers hardness to where it belongs: the cutting edge. The core of the knife remains soft to help protect against breakage and to also increase the ease of an eventual straightening.

 **Optimierte Härteverteilung**

Durch das spezielle Herstellungsverfahren wird die Härte genau dort hin gebracht, wo sie auch benötigt wird: in die Schneidkante. Der Kern des Messers bleibt weich und flexibel, was Bruch vorbeugt und das eventuelle Richten nach dem Nachschärfen vereinfacht.

 **Répartition optimale de la dureté**

Grâce au procédé de fabrication spécial, la dureté est là où besoin en est: au niveau du tranchant. Le noyau du couteau reste souple et flexible, ce qui prévient la rupture et simplifie l'ajustement après le réaffûtage.

 **Migliorata distribuzione della durezza**

Grazie ad una speciale produzione, la durezza del coltello é là dove é maggiormente richiesta, sul tagliente. La parte centrale del coltello rimane piú morbida e flessibile, si evitano così rotture e la riaffilatura é piú semplice.

 **Distribucion optimizada de la Dureza**

El exclusivo proceso permite distribuir la dureza en el filo de corte. El nucleo de la cuchilla permanece tenaz ayudando a evitar la rotura asi como permitiendo la planitud del cuerpo de la placa.



 **Polished cutting edge**

For an extra-aggressive cut in the wood, the cutting edge has a second, partial polish grind.

 **Polierte Schneidkante**

Für einen besonders giftigen Eingriff im Holz und eine sehr gute Holzoberfläche hat die Schneidkante einen zweiten, polierten Schliff.

 **Tranchant poli**

Le tranchant bénéficie d'un deuxième polissage, pour une coupe particulièrement nette et une très bonne surface de bois.

 **Tagliente parzialmente lappato**

Per un taglio su legno piú preciso e affilato, il tagliente é parzialmente lappato.

 **Lapeado del flanco de corte**

Para condiciones severas de corte en la madera , el filo de corte dispone de un doble acabado lapeado.



 **Black Oxide Surface**

The thin black surface layer of ferric oxide, only nanometers thick, runs across the top and bottom. This improves corrosion resistance and prevents early rusting.

 **Black Oxide Surface**

Die wenige Nanometer starke, schwarze Schicht aus Eisenoxyd auf Ober- und Unterseite macht das Messer beständiger gegen Korrosion und verhindert frühzeitiges Rosten.

 **Black Oxide Surface**





La couche noire en oxyde de fer, d'une épaisseur de quelques nanomètres sur le dessus et le dessous rend le couteau plus résistant contre la corrosion et la rouille anticipée.

 **Superficie „Black Oxide“**

La sottile superficie di ossido nero di ferro, rende il coltello piú resistente alla corrosione e alla ruggine.

 **Recubrimiento superficial-„Black Oxide“**

La superficie exterior permanece recubierta de oxido ferrico con espesores de nanómetros, mejorando la resistencia a la corrosion.

-  Knives for planing systems
-  Messer für Hobelsysteme
-  Couteaux pour outils à raboter
-  Coltelli per sistemi da pialla
-  Cuchillas para cepillar

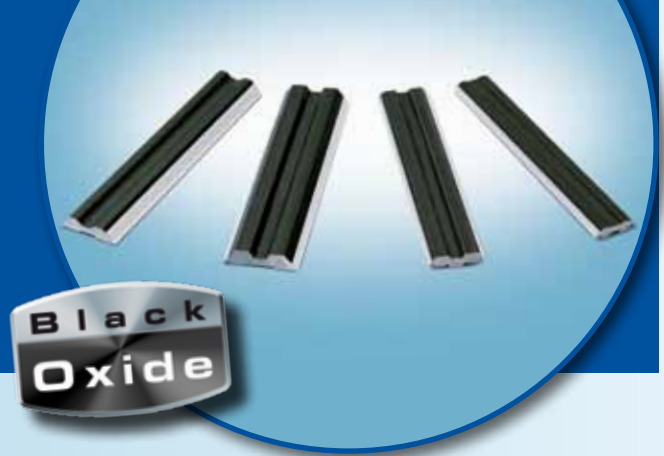

## Advantages

### Eco-friendly

As compared to knives ground from solid steel bars, the special manufacturing of this product consumes up to 30% less raw material, helping to avoid waste. Additionally, compared to traditional production methods, the energy consumption is up to 50% lower. These eco-friendly features help save the environment.

### Highest European quality

As always with TIGRA, our knives are of the highest European quality, manufactured on the most modern production lines.

### Real High Speed Steel

Real HSS for a long lifetime!

### Excellent pricing

In addition to these advantages, we offer the „black oxide“ knives at an unbeatable price!

## Vorteile

### Ökologisch sinnvoll

Im Vergleich zu aus Vollstahl geschliffenen Messern verbraucht die besondere Herstellmethode bis zu 30% weniger Rohstoffe und vermeidet so Abfälle. Zusätzlich sinkt der Energiebedarf bei der Herstellung um bis zu 50%! Das entlastet die Umwelt.

### Europäische Spitzenqualität

Wie immer bei TIGRA handelt es sich auch bei unseren HSS-Messern um ein europäisches Spitzenprodukt, welches auf modernsten Anlagen gefertigt wird.

### Echtes HSS

Echtes HSS für hohe Standwege.

### Unschlagbar günstiger Preis

Trotz all der genannten Vorteile können wir Ihnen diese HSS-Messer zu einem noch günstigeren Preis anbieten, der Sie sofort überzeugt.

## Avantages

### Ecologiquement judicieux

La méthode de production particulière utilise jusqu'à 30% moins de matières premières que les couteaux rectifiés en acier entier. Les déchets sont ainsi évités. En plus, lors de la fabrication, la consommation d'énergie baisse jusqu'à 50%! L'environnement est soulagé.

### L'excellence de la qualité européenne

Comme toujours chez TIGRA, pour les couteaux HSS, il s'agit d'un produit européen haut de gamme, fabriqué par les systèmes les plus modernes.

### HSS véritable

HSS véritable pour une tenue d'outil importante.

### Un prix imbattable défiant toute concurrence

Malgré tous les avantages énumérés, nous sommes en mesure de vous proposer ces couteaux HSS à un prix encore plus avantageux qui va vous séduire immédiatement.

## Vantaggi

### Ecologia a tutela dell'ambiente

Paragonati alla produzione di coltelli in acciaio rettificati, questa produzione fa risparmiare il 30% di materie prime e riduce quindi le scorie. Inoltre, il risparmio di energia è del 50%. Tutto questo tutela l'ambiente.

### All'apice della qualità europea

Anche per i coltelli in qualità HSS, la Tigra garantisce una qualità eccellente, grazie alla produzione su impianti moderni ed altamente tecnologici.

### Vero acciaio super rapido

Vero HSS per una prestazione di lunga durata.

### Prezzi imbattibili

Nonostante l'eccellente qualità, i prezzi dei coltelli in qualità HSS sono imbattibili e ancora più convenienti.

## Gabelas

### Eco-friendly – Ecologico

La producción de estas cuchillas se realiza utilizando materias primas de forma eficiente, permitiendo evitar mermas de material, ahorrando más del 30% de materia prima. Igualmente se obtienen mejoras en los consumos de energía por encima del 50% comparados con los métodos tradicionales de manufacturación. Estas características permiten preservar el medio ambiente.

### Excelente Calidad Europea

Los métodos de elaboración productivos a disposición de TIGRA GmbH, permiten garantizar unos elevados niveles de calidad en sus productos.

### Acero SuperAleado de Calidad Contrastada

HSS real para más durabilidad.

### Tarifas y Condiciones optimas

Las cuchillas recubiertas „black oxide“ ofrecen indudables ventajas, incluido sus condiciones económicas.







TIGRA coil cutting machine



-  Planer knives
-  Hobelmesser
-  Couteaux à raboter
-  Coltelli da pialla
-  Cuchillas para cepillar



-  Matrix - unique benefits by using TIGRA's special layered knives
-  Matrix - einzigartige Vorteile dank TIGRA's spezial-beschichteter Messer
-  Matrix - avantages uniques grâce aux couteaux TIGRA pourvus d'un revêtement spécial
-  Matrix - vantaggi straordinari utilizzando coltelli TIGRA speciali stratificati
-  Matrix - beneficios únicos utilizando cuchillos especiales capas de TIGRA

 **Highest lifetime = lowest cost**

Money is earned on the cutting edge: long lifetime leads to lowest cost per cut length, less machine downtimes, less changeovers, more accurate and repetitive profiles. Matrix knives offer 4-6 times higher lifetime when working wood, cutting not only wood but also your total costs.

**Ultra-thin layer = sharpest cut**

Different from many coatings (PCD, CVD, ...), Matrix coated knives have a layer of only 1/1000 mm, leaving the cutting edge extremely sharp instead of rounding them.

**Non-structured layer = minimum friction**

The special mix of elements and the special way of coating result in a surface with an extremely low friction coefficient – for better chip flow, lower resin adherence as well as faster & smoother cutting.

**Less energy, less waste = going green**

The long lifetime highly reduces waste of natural resources and polluting recycling processes. Thanks to the low friction, the tool itself uses less energy on the machine as well.

**Many resharpenings = even higher savings**

Matrix coated knives can be resharpened, multiplying your savings!

 **Höchste Lebensdauer = geringe Kosten**

Das Geld wird an der Schneidkante verdient: eine lange Lebensdauer bedeutet niedrigste Kosten pro Schnittlänge, geringere Stillstandszeiten, weniger Umstellungen, und bringt genauere, repetitive Profile. Matrix-Messer bieten 4-6 mal höhere Standwege in der Holzbearbeitung, beschneiden sowohl Holz als auch Ihre Gesamtkosten.

**Ultradünne Beschichtung = schärfster Schnitt**

Anders als bei vielen Beschichtungen (PKD, CVD, ...) haben Matrix-Messer eine Beschichtungsstärke von nur 1/1000 mm, wobei die Schneide extrem scharf bleibt und keine Rundungen entstehen.

**Nichtstrukturierte Schicht = minimale Reibung**

Die spezielle Mischung von Komponenten und die spezielle Art der Beschichtung führen zu einer Oberfläche mit einem extrem niedrigen Reibungskoeffizienten - zur besseren Spanabführung, geringerem Verkleben mit Harz sowie einem schnellen und gleichmäßigem Schneiden.

**Geringerer Energieaufwand, weniger Abfall = Going Green**

Die lange Lebensdauer reduziert die Verschwendung natürlicher Ressourcen und Umwelt verschmutzende Recyclingverfahren. Dank der geringen Reibung benötigt das Werkzeug wie die gesamte Maschine auch weniger Energie.

**Viele Nachschliffe = noch höhere Einsparungen**

Matrix-Messer können nachgeschliffen werden, was zur Multiplikation ihrer Einsparungen führt!

 **Durée de vie maximale = minimisation des coûts**

Les économies sont réalisées grâce à l'arête de coupe : une longue durée de vie signifie des coûts minimaux par longueur de coupe, des durées d'immobilisation plus courtes, moins de changements, et des profils plus précis et récurrents. Les couteaux Matrix proposent une tenue d'outil supérieure de 4 à 6 fois, coupent du bois, mais s'attaquent aussi vos coûts globaux.

**Revêtement ultra fin = coupe ultra vive**

Contrairement à nombre d'autres revêtements (PCD, CVD, ...), l'épaisseur de couche des couteaux Matrix est de 1/1000 mm seulement; l'arête reste extrêmement vive et il n'y a pas d'arrondis.

**Couche non structurée = friction minimale**

Le mélange spécial de composants et la technique particulière utilisée pour le revêtement font que l'on obtient une surface avec un coefficient de friction extrêmement bas - pour une meilleure évacuation des copeaux, une adhérence minimale à la résine et une coupe rapide et égale.

**Moins de dépenses énergétiques, moins de déchets = Going Green**

La longue durée de vie réduit les gaspillages des ressources naturelles et les procédés de recyclage polluant l'environnement. Grâce à la faible friction, les outils et toute la machine consomment moins d'énergie.





**Beaucoup d'affutages = davantage d'économies**

Les couteaux Matrix peuvent être affûtés, ce qui augmente vos économies.



-  Planer knives
-  Hobelmesser
-  Couteaux à raboter
-  Coltelli da pialla
-  Cuchillas para cepillar



-  Matrix - unique benefits by using TIGRA's special layered knives
-  Matrix - einzigartige Vorteile dank TIGRA's spezial-beschichteter Messer
-  Matrix - avantages uniques grâce aux couteaux TIGRA pourvus d'un revêtement spécial
-  Matrix - vantaggi straordinari utilizzando coltelli TIGRA speciali stratificati
-  Matrix - beneficios únicos utilizando cuchillos especiales capas de TIGRA

 **Massima durata = minor costo**

Il guadagno c'è sul filo della lama: una lunga durata porta a un costo più basso per lunghezza di taglio, tempi di fermo macchina ridotti, meno cambi di coltelli, profili più accurati e ripetitivi. Sulla lavorazione del legno i coltelli Matrix offrono una durata di 4 a 6 volte superiore ai coltelli normali. Tagliano non solo il legno ma anche i costi.

**Strato ultra-sottile = filo tagliente**

Diverso da molti rivestimenti (PCD, CVD, ...), il rivestimento dei coltelli Matrix hanno uno strato di solo 1/1000 mm, lasciando il filo della lama molto tagliente, senza arrotondarlo.

**Strato non strutturato = minimo attrito**

La miscela speciale di componenti ed il particolare rivestimento porta a una superficie con un coefficiente di attrito estremamente basso - per un miglior smaltimento del truciolo, un' inferiore adesione della resina e un taglio più veloce e agevole.

**Meno spreco d'energia, meno rifiuti = ecologia**

La lunga durata riduce al minimo lo spreco delle risorse naturali e la necessità di riciclaggi inquinanti. Grazie al basso coefficiente di attrito, l'utensile e la macchina utilizza meno energia.

**Molte riaffilature = risparmi ancora più elevati**

I coltelli Matrix possono essere riaffilati più volte, moltiplicando i tuoi risparmi!

 **Mayor vida útil = menor coste**

El dinero se gana en la vanguardia: larga vida conduce a menor costo por longitud de corte, menos tiempos de parada de la máquina, menos cambios de más perfiles precisos y repetitivos. Cuchillos Matrix ofrecen de por vida 6.4 veces mayor cuando se trabaja la madera, de corte no sólo la madera sino también sus costos totales.

**Capa ultra delgada = más aguda corte**

A diferencia de muchas capas (PCD, enfermedades cardiovasculares, ...), cuchillos Matrix cubierta tienen una capa de sólo 1 / 1000 mm, dejando el borde de corte muy afilados en lugar de redondeo ellos.

**Capa no estructred = fricción mínima**





La mezcla especial de elementos y la forma especial del resultado de recubrimiento en una superficie con un coeficiente de fricción extremadamente bajo - para un mejor flujo de la viruta, menor adherencia de la resina, así como el corte más rápido y más suave.

**Menos energía, menos residuos = verde que va**



El tiempo de vida muy larga reduce el desperdicio de los recursos naturales y contaminando los procesos de reciclado. Gracias a la baja fricción, la propia herramienta utiliza menos energía en el equipo también.



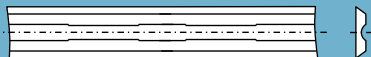

**Muchos resharpenings = ahorro aún mayor**

Cuchillos Matrix recubiertos puede volver a afilar, multiplicar sus ahorros!

-  Reversible knives for portable planers
-  Wendeschneidplatten für Handhobel
-  Plaquettes pour rabots électro portatifs
-  Coltelli piallatrici portatili
-  Cuchillas para acepilladoras electricas



	L mm	W mm	T mm	T08MF	
	56.0	5.5	1.1	013041	Adler
	60.0	5.5	1.1	013053	Wegoma
	75.5	5.5	1.1	013001	AEG, Bosch, Festo, Haffner, Kress, Mafell, Metabo, Scheer, Skil, Holz-Her
	78.0	5.5	1.1	013067	Virutex
	82.0	5.5	1.1	013082	Casals
	92.0	5.5	1.1	013057	AEG, Hitachi, Ryobi
	102.0	5.5	1.1	013061	AEG
	75.7	5.5	1.2	013018	B&D
	80.5	5.5	1.1	013010	ELU
	80.5	5.9	1.2	013043	ELU
	82.0	5.5	1.1	013020	AEG, B&D, Bosch, ALU, Fein, Felisatti, Haffner, Hitachi, Holz-Her, Mafell, Makita, Metabo, Peugeot, Ryobi, Skil
	82.7	5.5	1.1	013032	B&D
	82.0	5.1	1.2	013034	Face groove, Brustnut, Rainure sur grande face, Scanalatura frontale, Ranura frontal

-  System Planer knives
-  Systemhobelmesser
-  Couteaux à raboter pour système
-  Coltelli da pialla per sistema
-  Cuchillas para cepillar para sistema



For system Tersa\*

L mm	W mm	T mm	Black Oxide				
			HW T10MG	HSS Standard (M2)	HSS 18% (T1)	HSS M42	High Performance Steel
60.0	10.0	2.3	100847	100395	114482	114539	108320
75.0	10.0	2.3	104212	107545	114483	114540	115104
80.0	10.0	2.3	100848	100396	114484	114541	115105
90.0	10.0	2.3	104398	107546	114485	114542	115106
95.0	10.0	2.3	104211	107547	114486	114543	115107
100.0	10.0	2.3	055509	100397	114487	114544	108321
110.0	10.0	2.3	100849	100398	114488	114545	108322
115.0	10.0	2.3	105071	104630	114489	114546	108323
120.0	10.0	2.3	100851	100399	114490	114547	108324
125.0	10.0	2.3	104022	107548	114491	114548	115108
130.0	10.0	2.3	055510	100400	114492	114549	108325
135.0	10.0	2.3	103823	103821	114493	114550	108326
140.0	10.0	2.3	104766	104613	114494	114551	108327
145.0	10.0	2.3	104210	107549	114495	114552	115109
150.0	10.0	2.3	100852	100401	114496	114553	108328
160.0	10.0	2.3	103943	102716	114497	114554	108329
170.0	10.0	2.3	100853	100402	114498	114555	108330
180.0	10.0	2.3	100854	100403	114499	114556	108331
185.0	10.0	2.3	105070	102774	114500	114557	108332
190.0	10.0	2.3	104399	104808	114501	114558	108333
200.0	10.0	2.3	105698	104243	114502	114559	115121
210.0	10.0	2.3	100855	100404	114503	114560	108334
220.0	10.0	2.3	104589	104566	114504	114561	108335
230.0	10.0	2.3	055511	100405	114505	114562	108337
235.0	10.0	2.3	103824	101718	114506	114563	108338
240.0	10.0	2.3	104043	101720	114507	114564	108339
250.0	10.0	2.3	100856	100406	114508	114565	115110
260.0	10.0	2.3	100857	100407	114509	114566	108340
265.0	10.0	2.3	104573	104326	114510	114567	115111
270.0	10.0	2.3	101673	102982	114511	114568	115112





\* For use in Tersa-cutterheads only

\* Nur zur Verwendung in Tersa-Messerköpfen

\* Utilisation limitée aux porte outils de Tersa

\* Da usare solo su teste portacoltelli della Tersa

\* Sólo para empleo con portacuchillas de Tersa



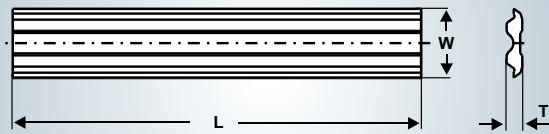

-  System Planer knives
-  Systemhobelmesser
-  Couteaux à raboter pour système
-  Coltelli da pialla per sistema
-  Cuchillas para cepillar para sistema



For system Tersa\*

L mm	W mm	T mm	Black Oxide				
			HW T10MG	HSS Standard (M2)	HSS 18% (T1)	HSS M42	High Performance Steel
280.0	10.0	2.3	100858	100408	114512	114569	115113
300.0	10.0	2.3	100859	100409	114513	114570	108341
310.0	10.0	2.3	055512	100410	114514	114571	108342
320.0	10.0	2.3	107550	104687	114515	114572	108343
330.0	10.0	2.3	100861	100411	114516	114573	108344
350.0	10.0	2.3	100862	100412	114517	114574	108345
360.0	10.0	2.3	100863	100413	114518	114575	115114
400.0	10.0	2.3	100864	100414	114519	114576	108346
410.0	10.0	2.3	055513	100415	114520	114577	108347
415.0	10.0	2.3	107551	105267	114521	114578	115115
420.0	10.0	2.3	100865	100416	114522	114579	108348
430.0	10.0	2.3	055514	100417	114523	114580	108349
450.0	10.0	2.3	100866	100418	114524	114581	108350
500.0	10.0	2.3	100867	100419	114525	114582	108351
510.0	10.0	2.3	055515	100420	114526	114583	108352
520.0	10.0	2.3	055516	100421	114527	114584	108353
530.0	10.0	2.3	100868	100422	114528	114585	108354
540.0	10.0	2.3	100869	100423	114529	114586	115116
600.0	10.0	2.3	104720	103994	114530	114587	108355
610.0	10.0	2.3	055517	100424	114531	114588	108356
630.0	10.0	2.3	055518	100425	114532	114589	108357
635.0	10.0	2.3	102179	103912	114533	114590	108358
640.0	10.0	2.3	100870	100426	114534	114591	108359
650.0	10.0	2.3	055519	100427	114535	114592	108361
710.0	10.0	2.3		114119	114536	114593	115117
810.0	10.0	2.3		113435	114537	114594	115118
1050.0	10.0	2.3		114599	114538	114595	115119
Coil 60 meters				115127	116526	115128	115129
Coil 120 meters				110719	115191	114791	115120
Packing paper coil (60 meters for paired packing)				112874	112874	112874	112874

\* For use in Tersa-cutterheads only  
 \* Nur zur Verwendung in Tersa-Messerköpfen  
 \* Utilisation limitée aux porte outils de Tersa  
 \* Da usare solo su teste portacoltelli della Tersa  
 \* Sólo para empleo con portacuchillas de Tersa

-  System Planer knives
-  Systemhobelmesser
-  Couteaux à raboter pour système
-  Coltelli da pialla per sistema
-  Cuchillas para cepillar para sistema

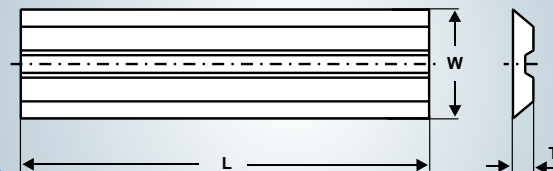

For system Centrolock\*

L mm	W mm	T mm	Black Oxide	
			HW T10MG	HSS Standard (M2)
10.0	16.0	3.0	102953	114728
20.0	16.0	3.0	100836	114729
30.0	16.0	3.0	102777	114730
40.0	16.0	3.0	102954	114731
50.0	16.0	3.0	102778	114732
60.0	16.0	3.0	100837	114733
65.0	16.0	3.0	107536	114734
80.0	16.0	3.0	100838	114735
100.0	16.0	3.0	055502	114736
115.0	16.0	3.0	106848	114737
130.0	16.0	3.0	055503	114738
140.0	16.0	3.0	107537	114739
150.0	16.0	3.0	100839	114740
160.0	16.0	3.0	105003	114741
170.0	16.0	3.0	055504	114742
180.0	16.0	3.0	100840	114743
190.0	16.0	3.0	100841	114744
210.0	16.0	3.0	100842	114745
220.0	16.0	3.0	107538	114746
230.0	16.0	3.0	054753	114747
235.0	16.0	3.0	100844	114748
240.0	16.0	3.0	055505	114749
260.0	16.0	3.0	100845	114750
270.0	16.0	3.0	055506	114751
300.0	16.0	3.0	102493	114752
310.0	16.0	3.0	100846	114753
460.0	16.0	3.0	055507	114754
650.0	16.0	3.0	055508	114755
710.0	16.0	3.0		114756
810.0	16.0	3.0		114757
1050.0	16.0	3.0		114758

\* For use in Centrolock-cutterheads only

\* Nur zur Verwendung in Centrolock-Messerköpfen





\* Utilisation limitée aux porte outils de Centrolock

\* Da usare solo su teste portacoltelli della Centrolock

\* Sólo para empleo con portacuchillas de Centrolock





-  System Planer knives
-  Systemhobelmesser
-  Couteaux à raboter pour système
-  Coltelli da pialla per sistema
-  Cuchillas para cepillar para sistema



For system Terminus\*

L	W	T	Black Oxide		
			HW	HSS	HSS
mm	mm	mm	T10MG	Standard (M2)	18% (T1)
50.0	14.0	2.55	100796	114601	114649
60.0	14.0	2.55	100803	114602	114650
80.0	14.0	2.55	100804	114603	114651
100.0	14.0	2.55	100805	114604	114652
110.0	14.0	2.55	100806	114605	114653
120.0	14.0	2.55	100807	114606	114654
130.0	14.0	2.55	055496	114607	114655
136.0	14.0	2.55	107532	114608	114656
140.0	14.0	2.55	100808	114609	114657
150.0	14.0	2.55	100809	114610	114658
160.0	14.0	2.55	100811	114611	114659
170.0	14.0	2.55	100812	114612	114660
180.0	14.0	2.55	100813	114613	114661
190.0	14.0	2.55	100814	114614	114662
200.0	14.0	2.55	100815	114615	114663
210.0	14.0	2.55	100816	114616	114664
220.0	14.0	2.55	100817	114617	114665
230.0	14.0	2.55	054752	114618	114666
240.0	14.0	2.55	100818	114619	114667
250.0	14.0	2.55	100819	114620	114668
255.0	14.0	2.55	107533	114621	114669
260.0	14.0	2.55	100820	114622	114670
270.0	14.0	2.55	100821	114623	114671
275.0	14.0	2.55	107534	114624	114672
280.0	14.0	2.55	100822	114625	114673

L	W	T	Black Oxide		
			HW	HSS	HSS
mm	mm	mm	T10MG	Standard (M2)	18% (T1)
300.0	14.0	2.55	100823	114626	114674
310.0	14.0	2.55	055497	114627	114675
330.0	14.0	2.55	107535	114628	114676
350.0	14.0	2.55	100824	114629	114677
360.0	14.0	2.55	100825	114630	114678
400.0	14.0	2.55	100826	114631	114679
410.0	14.0	2.55	055498	114632	114680
420.0	14.0	2.55	100828	114633	114681
430.0	14.0	2.55	100829	114634	114682
450.0	14.0	2.55	100830	114635	114683
480.0	14.0	2.55	100940	114636	114684
500.0	14.0	2.55	104977	114637	114685
510.0	14.0	2.55	055499	114638	114686
520.0	14.0	2.55	100831	114639	114687
530.0	14.0	2.55	100832	114640	114688
610.0	14.0	2.55	055500	114641	114689
620.0	14.0	2.55	100833	114642	114690
630.0	14.0	2.55	100834	114643	114691
640.0	14.0	2.55	100835	114644	114692
650.0	14.0	2.55	055501	114645	114693
710.0	14.0	2.55		114646	114694
810.0	14.0	2.55		114647	114695
1050.0	14.0	2.55		114648	114696





\* For use in Terminus-cutterheads only

\* Nur zur Verwendung in Terminus-Messerköpfen

\* Utilisation limitée aux porte outils de Terminus

\* Da usare solo su teste portacoltelli della Terminus

\* Sólo para empleo con portacuchillas de Terminus

-  System Planer knives
-  Systemhobelmesser
-  Couteaux à raboter pour système
-  Coltelli da pialla per sistema
-  Cuchillas para cepillar para sistema

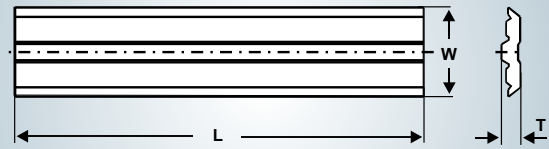





For system Centrofix/  
Centrostar/ Quickfix\*

L mm	W mm	T mm	Black Oxide		
			HW T10MG	HSS Standard (M2)	HSS 18% (T1)
50.0	12.0	2.7	100876	100896	114762
80.0	12.0	2.7	100879	100897	114763
100.0	12.0	2.7	100880	100898	114764
120.0	12.0	2.7	100881	100899	114765
130.0	12.0	2.7	055520	055488	114766
136.0	12.0	2.7	100883	100900	114767
150.0	12.0	2.7	100884	100901	114768
170.0	12.0	2.7	100885	100902	114769
180.0	12.0	2.7	055521	055489	114770
190.0	12.0	2.7	100886	100904	114771
210.0	12.0	2.7	100887	100905	114772
230.0	12.0	2.7	055522	055490	114773
240.0	12.0	2.7	100890	100906	114774
310.0	12.0	2.7	101675	103165	114775
400.0	12.0	2.7	100891	100907	114776
410.0	12.0	2.7	055523	055491	114777
420.0	12.0	2.7	100892	100908	114778
430.0	12.0	2.7	100893	100909	114779
500.0	12.0	2.7	100894	100910	114780
510.0	12.0	2.7	055524	055492	114781
520.0	12.0	2.7	055525	055493	114782
530.0	12.0	2.7	055526	055494	114783
540.0	12.0	2.7	100895	100911	114784
630.0	12.0	2.7	107553	103814	114785
640.0	12.0	2.7	107554	107474	114786
650.0	12.0	2.7	055527	055495	114787
710.0	12.0	2.7		101046	114788
810.0	12.0	2.7		108226	114789
1050.0	12.0	2.7		114760	114790
	<b>Coil 60 meters</b>			<b>121137</b>	
	<b>Coil 120 meters</b>			<b>112205</b>	
	<b>Packing paper coil (60 meters for paired packing)</b>			<b>112877</b>	

\* For use in Centrofix/Centrostar/Quickfix-cutterheads only  
 \* Nur zur Verwendung in Centrofix/Centrostar/Quickfix-Messerköpfen  
 \* Utilisation limitée aux porte outils de Centrofix/Centrostar/Quickfix  
 \* Da usare solo su teste portacoltelli della Centrofix/Centrostar/Quickfix  
 \* Sólo para empleo con portacuchillas de Centrofix/Centrostar/Quickfix



-  System Planer knives
-  Systemhobelmesser
-  Couteaux à raboter pour système
-  Coltelli da pialla per sistema
-  Cuchillas para cepillar para sistema

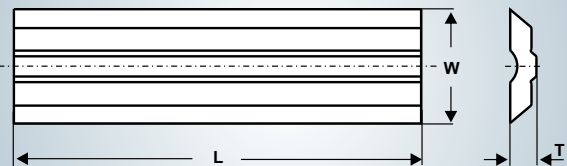





For system Variplan\*

L mm	W mm	T mm	Black Oxide	
			HW T10MG	HSS Standard (M2)
50	16.0	3.7	116764	116737
60	16.0	3.7	116765	116738
80	16.0	3.7	116766	116739
100	16.0	3.7	116767	116740
120	16.0	3.7	116768	116741
130	16.0	3.7	109662	116319
136	16.0	3.7	116769	116742
150	16.0	3.7	116770	116743
170	16.0	3.7	108654	116744
180	16.0	3.7	116771	116745
190	16.0	3.7	116772	116746
210	16.0	3.7	107585	116747
230	16.0	3.7	116773	116320
240	16.0	3.7	116774	116321
400	16.0	3.7	116775	116748
410	16.0	3.7	107586	116322
420	16.0	3.7	116776	116749
430	16.0	3.7	116777	116750
500	16.0	3.7	116778	116751
510	16.0	3.7	116779	116752
520	16.0	3.7	116780	116753
530	16.0	3.7	116781	116754
540	16.0	3.7	116782	116755
600	16.0	3.7	116783	116756
610	16.0	3.7	116784	116757
630	16.0	3.7	116785	116758
640	16.0	3.7	116786	116759
1050	16.0	3.7		115845

\* For use in Variplan-cutterheads only  
 \* Nur zur Verwendung in Variplan-Messerköpfen  
 \* Utilisation limitée aux porte outils de Variplan  
 \* Da usare solo su teste portacoltelli della Variplan  
 \* Sólo para empleo con portacuchillas de Variplan





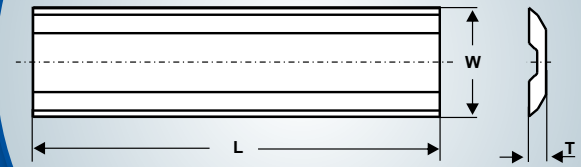

-  System Planer knives
-  Systemhobelmesser
-  Couteaux à raboter pour système
-  Coltelli da pialla per sistema
-  Cuchillas para cepillar para sistema



For system Sinus\*

L mm	W mm	T mm	HW	Black Oxide HSS
			T10MG	Standard (M2)
80	16.0	2.5	116711	116680
100	16.0	2.5	116712	116681
120	16.0	2.5	116713	116682
130	16.0	2.5	116714	116311
140	16.0	2.5	116715	116683
150	16.0	2.5	116716	116312
160	16.0	2.5	116717	116684
180	16.0	2.5	116718	116313
190	16.0	2.5	116719	116685
200	16.0	2.5	116720	116686
210	16.0	2.5	116721	116687
220	16.0	2.5	116722	116688
230	16.0	2.5	116723	116314
240	16.0	2.5	116724	116315
250	16.0	2.5	116725	116689
260	16.0	2.5	116726	116690
300	16.0	2.5	116727	116691
310	16.0	2.5	116728	116692
400	16.0	2.5	116729	116693
410	16.0	2.5	116730	116694
430	16.0	2.5	116731	116695
500	16.0	2.5	116732	116696
510	16.0	2.5	116733	116697
610	16.0	2.5	116734	116698
630	16.0	2.5	116735	116699
640	16.0	2.5	116736	116700
710	16.0	2.5		116701
1050	16.0	2.5		115412
1350	16.0	2.5		115486

\* For use in Sinus-cutterheads only  
 \* Nur zur Verwendung in Sinus-Messerköpfen  
 \* Utilisation limitée aux porte outils de Sinus  
 \* Da usare solo su teste portacoltelli della Sinus  
 \* Sólo para empleo con portacuchillas de Sinus



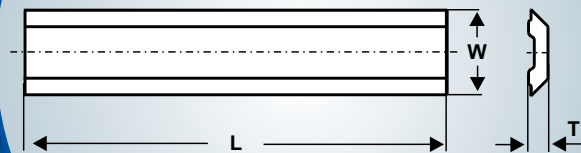

-  System Planer knives
-  Systemhobelmesser
-  Couteaux à raboter pour système
-  Coltelli da pialla per sistema
-  Cuchillas para cepillar para sistema



For system Enshin\*

L mm	W mm	T mm	HW	Black Oxide HSS
			T10MG	Standard (M2)
80	12.0	2.7	116794	116787
100	12.0	2.7	116796	116788
130	12.0	2.7	116797	116316
150	12.0	2.7	116798	116789
170	12.0	2.7	116799	116790
180	12.0	2.7	116800	116317
190	12.0	2.7	116801	116791
210	12.0	2.7	116802	116792
230	12.0	2.7	116803	116318
240	12.0	2.7	116804	116793
640	12.0	2.7	116805	
1050	12.0	2.7		115846

\* For use in Enshin-cutterheads only  
 \* Nur zur Verwendung in Enshin-Messerköpfen  
 \* Utilisation limitée aux porte outils de Enshin  
 \* Da usare solo su teste portacottelli della Enshin  
 \* Sólo para empleo con portacuchillas de Enshin



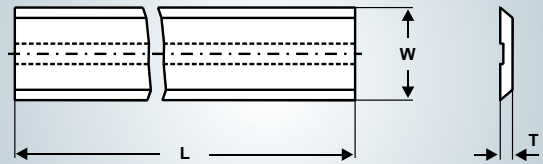

-  System Planer knives
-  Systemhobelmesser
-  Couteaux à raboter pour système
-  Coltelli da pialla per sistema
-  Cuchillas para cepillar para sistema



For system Bulldozer

L mm	W mm	T mm	T10MG
60.0	13.6	1.8	047422
70.0	13.6	1.8	013728
80.0	13.6	1.8	046288
100.0	13.6	1.8	013713
110.0	13.6	1.8	047423
120.0	13.6	1.8	013715
130.0	13.6	1.8	013716
140.0	13.6	1.8	013723
150.0	13.6	1.8	013718
160.0	13.6	1.8	013726
180.0	13.6	1.8	013719
190.0	13.6	1.8	013725
200.0	13.6	1.8	013720
220.0	13.6	1.8	049247
230.0	13.6	1.8	013721
240.0	13.6	1.8	040337
250.0	13.6	1.8	013722
260.0	13.6	1.8	035440



-  HSS/High Perform. Steel/Matrix planer knives
-  HSS/High Perform. Steel/Matrix Hobelmesser
-  Fers de raboteuse HSS/High Perform. Steel/Matrix
-  Coltelli da pialla HSS/High Perform. Steel/Matrix
-  Cuchillas en HSS/High Perform. Steel/Matrix

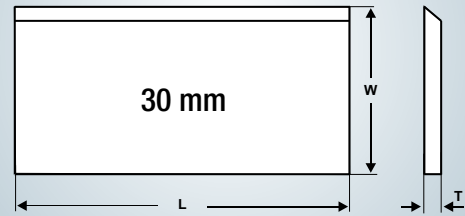





HSS/  
High Performance Steel  
Matrix



L	W	T	HSS	HSS	High Performance Steel	Matrix coating technology
mm	mm	mm	Standard (M2)	18% (T1)		
60.0	30.0	3.0	030152	111908	104114	120140
80.0	30.0	3.0	030153	111913	104116	120141
100.0	30.0	3.0	030154	111914	104121	120142
110.0	30.0	3.0	030156	111915	104122	120143
120.0	30.0	3.0	030157	111916	104123	120144
130.0	30.0	3.0	030159	111917	104124	120145
150.0	30.0	3.0	030162	111918	104125	120146
160.0	30.0	3.0	030163	111919	107557	120147
170.0	30.0	3.0	030164	111920	107558	120148
180.0	30.0	3.0	030165	111921	104126	120149
210.0	30.0	3.0	030168	111922	104127	120150
230.0	30.0	3.0	030171	111923	104128	120151
240.0	30.0	3.0	030172	111924	107559	120153
260.0	30.0	3.0	030174	111925	104129	120154
300.0	30.0	3.0	030175	111926	104130	120155
310.0	30.0	3.0	030176	111927	104131	120156
350.0	30.0	3.0	030178	111928	107560	120157
400.0	30.0	3.0	030182	111929	107561	120158
410.0	30.0	3.0	030183	111930	104132	120159
500.0	30.0	3.0	030186	111931	107562	120160
510.0	30.0	3.0	030187	111932	104133	120161
520.0	30.0	3.0	101376	111933	107563	120162
530.0	30.0	3.0	030188	111934	107564	120163
600.0	30.0	3.0	030190	111935	107565	120164
610.0	30.0	3.0	030191	111936	104134	120165
630.0	30.0	3.0	030192	111937	104135	120166
640.0	30.0	3.0	030194	111938	104136	120167
710.0	30.0	3.0	030198	111939	104137	120168
810.0	30.0	3.0	030201	111940	104138	120169
820.0	30.0	3.0	101051	111941	104139	120170
1050.0	30.0	3.0	030249	111942	104140	120171

Other dimensions upon request.  
Andere Abmessungen auf Anfrage.  
D'autres dimensions sur demande.  
Altri dimensioni a richiesta.  
Otras dimensiones bajo demanda.

-  HSS/High Perform. Steel/Matrix planer knives
-  HSS/High Perform. Steel/Matrix Hobelmesser
-  Fers de raboteuse HSS/High Perform. Steel/Matrix
-  Coltelli da pialla HSS/High Perform. Steel/Matrix
-  Cuchillas en HSS/High Perform. Steel/Matrix

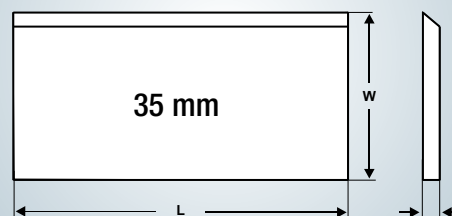





HSS/  
High Performance Steel  
Matrix



L	W	T	HSS	HSS	High Performance Steel	Matrix coating technology
mm	mm	mm	Standard (M2)	18% (T1)		
60.0	35.0	3.0	030205	111944	104141	120173
80.0	35.0	3.0	030206	111945	104142	120174
100.0	35.0	3.0	030207	111946	104143	120175
110.0	35.0	3.0	030208	111947	104144	120176
120.0	35.0	3.0	030209	111948	104145	120178
130.0	35.0	3.0	030210	111949	104146	120179
150.0	35.0	3.0	030211	111950	104147	120180
160.0	35.0	3.0	030212	111951	107573	120181
170.0	35.0	3.0	030213	111952	107574	120182
180.0	35.0	3.0	030214	111953	104148	120183
210.0	35.0	3.0	030217	111954	104149	120185
230.0	35.0	3.0	030218	111955	104150	120186
240.0	35.0	3.0	107570	111956	107575	120188
260.0	35.0	3.0	030220	111957	104151	120189
300.0	35.0	3.0	048006	111958	104152	120190
310.0	35.0	3.0	030222	111959	104153	120191
350.0	35.0	3.0	107571	111960	107576	120192
400.0	35.0	3.0	030225	111961	107577	120193
410.0	35.0	3.0	030226	111962	104154	120194
500.0	35.0	3.0	030230	111963	107578	120195
510.0	35.0	3.0	030231	111964	104155	120196
520.0	35.0	3.0	030232	111965	107579	120197
530.0	35.0	3.0	030233	111966	107580	120198
600.0	35.0	3.0	030234	111967	107581	120199
610.0	35.0	3.0	030235	111968	104156	120200
630.0	35.0	3.0	030236	111969	104157	120201
640.0	35.0	3.0	030237	111970	104158	120202
710.0	35.0	3.0	030240	111971	104159	120203
810.0	35.0	3.0	030243	111972	104160	120204
820.0	35.0	3.0	101052	111973	104161	120207
1050.0	35.0	3.0	030252	111974	104162	120208

Other dimensions upon request.  
Andere Abmessungen auf Anfrage.  
D'autres dimensions sur demande.  
Altri dimensioni a richiesta.  
Otras dimensiones bajo demanda.

-  HSS/High Perform. Steel/Matrix planer knives
-  HSS/High Perform. Steel/Matrix Hobelmesser
-  Fers de raboteuse HSS/High Perform. Steel/Matrix
-  Coltelli da pialla HSS/High Perform. Steel/Matrix
-  Cuchillas en HSS/High Perform. Steel/Matrix

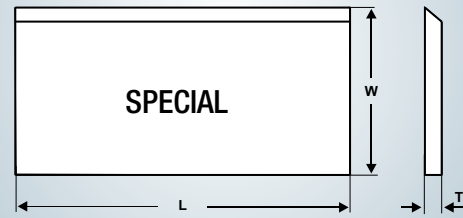

HSS/  
High Performance Steel  
Matrix



 Special dimensions  Spezialmaße  Dimensions spéciales  Dimensioni speciali  Dimensiones especiales

L	W	T	HSS	HSS	High Performance Steel	Matrix coating technology
mm	mm	mm	Standard (M2)	18% (T1)		
1050.0	20.0	2.5	106992	122065	118975	122071
1050.0	25.0	2.5	106994	116185	116186	122072

L	W	T	HSS	HSS	High Performance Steel	Matrix coating technology
mm	mm	mm	Standard (M2)	18% (T1)		
1050.0	25.0	3.0	101030	111975	107566	120209
1050.0	32.0	3.0	101938	111976	107567	120210

Other dimensions upon request.  
Andere Abmessungen auf Anfrage.  
D'autres dimensions sur demande.  
Altri dimensioni a richiesta.  
Otras dimensiones bajo demanda.



 T.C.T. planer knives

 HM-bestückte Hobelmesser

 Couteaux à mise rapportée carbure

 Coltelli da pialla con metallo duro riportato





 Cuchillas con metal duro



T.C.T.  
mm

L mm	T mm	W = 25 mm	W = 30 mm	W = 35 mm
60.0	3.0	114850	029969	030021
80.0	3.0	114851	029970	030022
100.0	3.0	113770	029972	030024
110.0	3.0	114852	029973	030025
120.0	3.0	111723	029974	030026
130.0	3.0	103946	029975	030027
150.0	3.0	105829	029979	030029
160.0	3.0	029943	029980	030030
170.0	3.0	114853	029981	030031
180.0	3.0	105830	029982	030032
200.0	3.0	110737	029986	030034
210.0	3.0	108651	029987	030035
230.0	3.0	112774	029989	030036
240.0	3.0	114854	029991	030038
250.0	3.0	029952	029993	030039
260.0	3.0	104917	029994	030040
270.0	3.0	107022	101697	107555
300.0	3.0	112585	029996	030041
310.0	3.0	029955	029997	030042
330.0	3.0	114855	002238	055837
350.0	3.0	114856	029998	030044
400.0	3.0	029957	029999	107556
410.0	3.0	104919	030001	030047
500.0	3.0	029960	030006	030049
510.0	3.0	104920	030007	030050
520.0	3.0	109690	030009	103998
530.0	3.0	114857	051130	030051
600.0	3.0	112963	030011	030052
610.0	3.0	114858	030012	030054
630.0	3.0	114859	030013	030055
640.0	3.0	114860	030014	030057
680.0	3.0	114861	114849	106194
710.0	3.0	114862	030016	030058
810.0	3.0	029967	030018	030059
820.0	3.0	107126	100445	100446
1010.0	3.0	030128	030131	030137
1050.0	3.0	104830	030132	030138

Other dimensions upon request.  
Andere Abmessungen auf Anfrage.  
D'autres dimensions sur demande.  
Altri dimensioni a richiesta.  
Otras dimensiones bajo demanda.

-  Solid carbide planer knives
-  Vollhartmetall Hobelmesser
-  Couteaux à raboter au carbure massif
-  Coltelli da pialla in HM integrale
-  Cuchillas metal duro integral

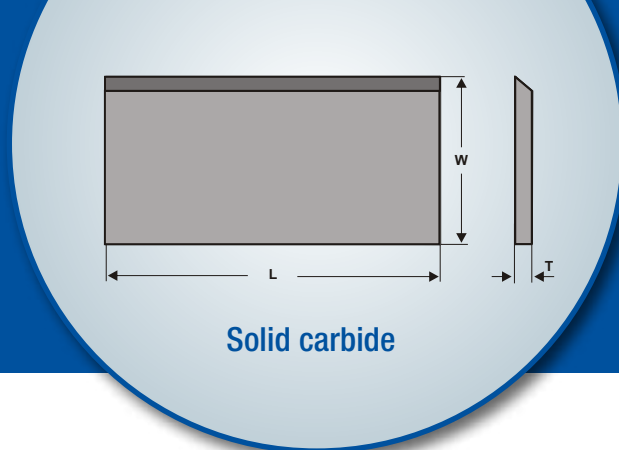





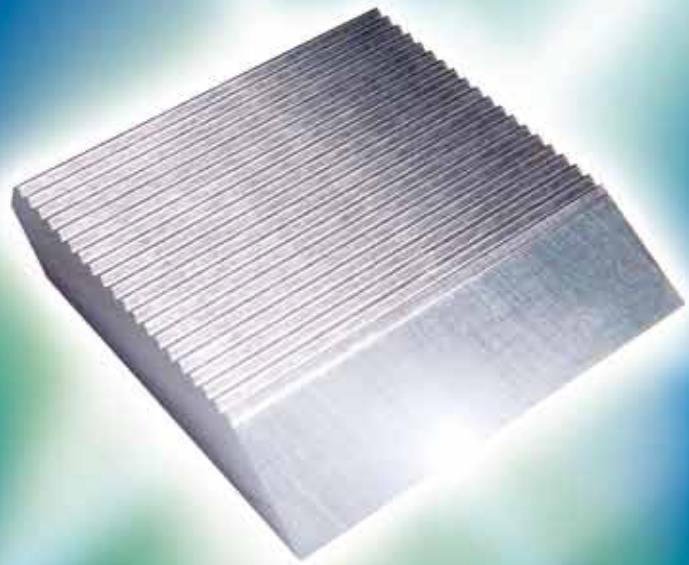

L mm	W mm	T mm	T10MG
60.0	30.0	3.0	050050
80.0	30.0	3.0	050051
100.0	30.0	3.0	042029
110.0	30.0	3.0	050053
120.0	30.0	3.0	050055
130.0	30.0	3.0	044900
150.0	30.0	3.0	042030
160.0	30.0	3.0	105941
180.0	30.0	3.0	050057
190.0	30.0	3.0	112087
210.0	30.0	3.0	050059
230.0	30.0	3.0	049223
240.0	30.0	3.0	106296
250.0	30.0	3.0	109344
260.0	30.0	3.0	049222
310.0	30.0	3.0	050061
60.0	35.0	3.0	047867
80.0	35.0	3.0	047868
100.0	35.0	3.0	047869
110.0	35.0	3.0	050065
120.0	35.0	3.0	050067
130.0	35.0	3.0	047870
150.0	35.0	3.0	050070
160.0	35.0	3.0	105954
180.0	35.0	3.0	050072
190.0	35.0	3.0	114848
210.0	35.0	3.0	050074
230.0	35.0	3.0	049669
240.0	35.0	3.0	114846
250.0	35.0	3.0	114847
260.0	35.0	3.0	050077
310.0	35.0	3.0	050079

Only for use in special clamping systems for carbide knives, not in conventional planing heads!  
 Nur in Spezialklemmsystemen für Vollhartmetallhobelmesser einsetzen, nicht in herkömmlichen Hobelköpfen!



**Tools cut better  
with TIGRA**





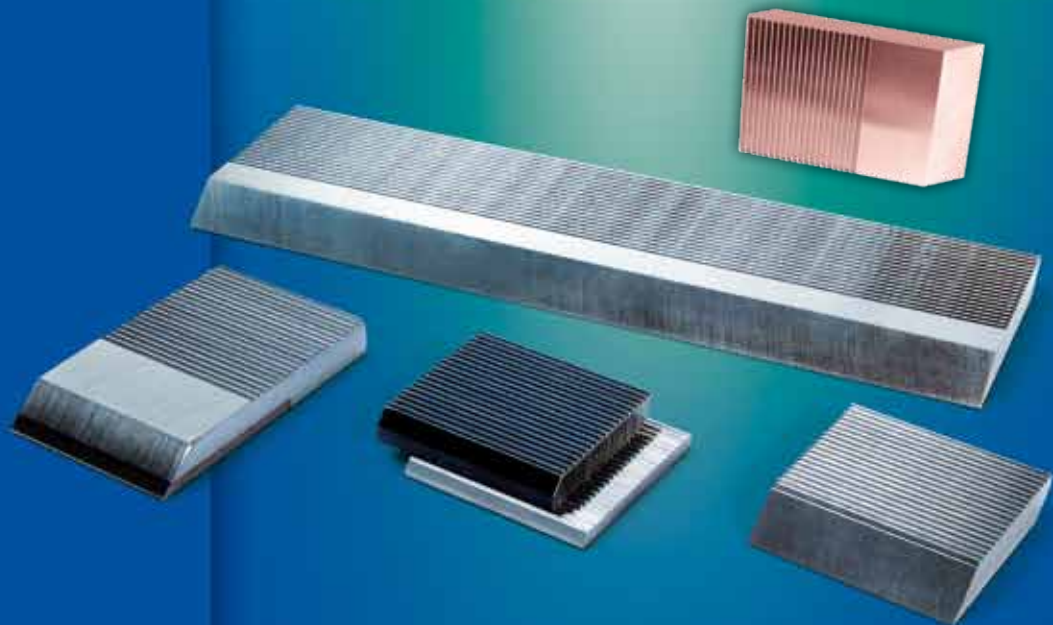











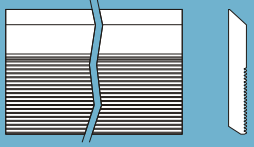





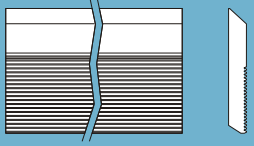





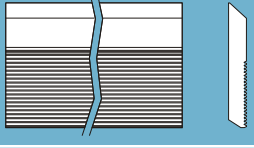





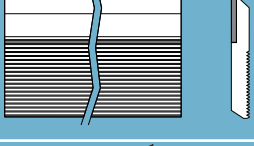

-  **Knives for back corrugated cutterheads**
-  **Messer für rückenverzahnte Messerköpfe**
-  **Couteaux pour outils crantés**
-  **Coltelli per teste con zigrinatura**
-  **Cuchillas corrugadas**



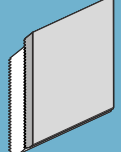



















-  Knives for back corrugated cutterheads - TIGRA materials and their applications
-  Messer für rückenverzahnte Messerköpfe - TIGRA Materialien und ihre Anwendungen
-  Couteaux pour outils crantés - Les matériaux TIGRA et leurs applications
-  Coltelli per teste con zigrinatura - I materiali TIGRA e le loro applicazioni
-  Cuchillas corrugadas - Los materiales TIGRA y sus aplicaciones

	<ul style="list-style-type: none"> <li> HSS / High Performance Steel blanks, back corrugated 8 mm</li> <li> HSS / High Performance Steel Blanketts, rückenverzahnt 8 mm</li> <li> HSS / High Performance Steel fers crantés 8 mm</li> <li> HSS / High Performance Steel placchette, con zigrinatura 8 mm</li> <li> HSS / High Performance Steel cuchillas corrugadas 8 mm</li> </ul>	<div style="background-color: #c00; color: white; border-radius: 10px; padding: 5px; display: inline-block;">141-142</div>
	<ul style="list-style-type: none"> <li> HSS / High Performance Steel blanks, back corrugated 4-6 mm</li> <li> HSS / High Performance Steel Blanketts, rückenverzahnt 4-6 mm</li> <li> HSS / High Performance Steel fers crantés 4-6 mm</li> <li> HSS / High Performance Steel placchette, con zigrinatura 4-6 mm</li> <li> HSS / High Performance Steel cuchillas corrugadas 4-6 mm</li> </ul>	<div style="background-color: #c00; color: white; border-radius: 10px; padding: 5px; display: inline-block;">143</div>
	<ul style="list-style-type: none"> <li> HSS / High Performance Steel blanks, back corrugated inch</li> <li> HSS / High Performance Steel Blanketts, rückenverzahnt inch</li> <li> HSS / High Performance Steel fers crantés inch</li> <li> HSS / High Performance Steel placchette, con zigrinatura inch</li> <li> HSS / High Performance Steel cuchillas corrugadas inch</li> </ul>	<div style="background-color: #c00; color: white; border-radius: 10px; padding: 5px; display: inline-block;">144</div>
	<ul style="list-style-type: none"> <li> T.C.T. blanks, back corrugated</li> <li> HM-bestückte Blanketts, rückenverzahnt</li> <li> Fers crantés au carbure rapportée</li> <li> Placchette saldo-brasato, con zigrinatura</li> <li> Cuchillas metal duro, corrugadas</li> </ul>	<div style="background-color: #c00; color: white; border-radius: 10px; padding: 5px; display: inline-block;">145-146</div>
	<ul style="list-style-type: none"> <li> SuperPac - T.C. knives and backing plates for back corrugated cutterheads</li> <li> SuperPac - HM-Messer und Stützplatten für rückenverzahnte Messerköpfe</li> <li> SuperPac - Couteaux au carbure et supports pour outils crantés</li> <li> SuperPac - Coltelli HW e supporti per teste con rigatura</li> <li> SuperPac - Placas de metal duro y placas de apoyo para fresas dentadas</li> </ul>	<div style="background-color: #c00; color: white; border-radius: 10px; padding: 5px; display: inline-block;">147-148</div>

-  Knives for back corrugated cutterheads - TIGRA materials and their applications
-  Messer für rückenverzahnte Messerköpfe - TIGRA Materialien und ihre Anwendungen
-  Couteaux pour outils crantés - Les matériaux TIGRA et leurs applications
-  Coltelli per teste con zigrinatura - I materiali TIGRA e le loro applicazioni
-  Cuchillas corrugadas - Materiales TIGRA y su aplicación

 Back corrugated knives  Rückenverzahnte Messer  Couteaux pour outils crantés  Coltelli per teste con rigatura  Cuchillas corrugadas	Lifetime Standzeit Durée de vie Durata Vida	Price Preis Prix Prezzo Precio	Ease of use Einfache Anwendung Simple d'utilisation Semplice uso Simple aplicación	Overall Gesamturteil Générale Giudizio finale En general veredicto
<b>HSS</b>	+	++	+++	+++
<b>High Performance Steel</b>	0	+++	++	++
<b>T.C.T.</b>	++	++	+	+
<b>SuperPac</b>	+++	+	0	+++
<b>Matrix - coating technology</b>	+++	+	++	+++

 Back corrugated knives  Rückenverzahnte Messer  Couteaux pour outils crantés  Coltelli per teste con rigatura  Cuchillas corrugadas	Main usage Hauptanwendung Principal usage Main uso Uso principal
<b>HSS</b>	Universal grade for small and medium batches Universalsorte für kleine und mittlere Losgrößen Nuance universelle pour des parts petites et moyennes Qualità universale per piccole e medie quantità Calidad universal para pequeñas y medias cantidades
<b>High Performance Steel</b>	Softwood, low price demand Weichholz, niedriger Preis Bois moux, pris bas Legni teneri, prezzo ridotto Madera blanda, precio economico
<b>T.C.T.</b>	Higher lifetime demands in wood, chipboard and MDF Gehobene Standzeitansprüche in Holz, Spanplatte und MDF Recours à une tenue de coupe plus haute pour le travail du bois, du panneau et du MDF Maggiore durata per legno, truciolare e MDF Requisitos de maderas de máximo rendimiento, aglomerados y MDF
<b>SuperPac</b>	Highest lifetime demands, wood and MDF Höchste Standzeitansprüche in Holz und MDF Recours à une tenue de coupe très haute pour le travail du bois et du MDF Massima durata per legno e MDT Duracion de vida optimizado, madera y MDF
<b>Matrix - coating technology</b>	Long lifetime and good resharpening, consistent profiles Hohe Standwege und gute Nachschärfbarkeit, gleichbleibende Profile Longue durée de vie et bonne rectification, profils constants Lunga durata e buona riaffilatura, profili invariati Prolongada vida útil, buena rectificabilidad, perfiles estables

-  **Knives for back corrugated cutterheads - TIGRA materials and their applications**
-  **Messer für rückenverzahnte Messerköpfe - TIGRA Materialien und ihre Anwendungen**
-  **Couteaux pour outils crantés - Les matériaux TIGRA et leurs applications**
-  **Coltelli per teste con zigrinatura - I materiali TIGRA e le loro applicazioni**
-  **Cuchillas corrugadas - Materiales TIGRA y su aplicación**

 **TIGRA is one of the leading suppliers of inserts for back corrugated cutterheads.**  
Our wide range of blanks includes:



**HSS:** the classic blank for corrugated cutterheads:

- High Quality German manufactured steel
- Precision-ground corrugation
- Excellent grindability
- Available from stock



**High Performance Steel:** the economic alternative to HSS:

- High Quality German manufactured steel
- Very good lifetime in most applications
- Lower price than standard HSS
- Easier to cut than HSS
- Precision-ground corrugation

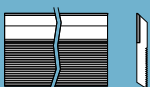

**T.C.T.:** Brazed-on carbide where the lifetime of HSS and High Performance Steel is not sufficient

- Very long lifetime
- High hardness
- High quality

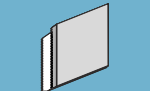

**SuperPac:** the high-end blank that enables multiple regrinds because of the precise corrugation in the carbide blank. SuperPac is available in different carbide grades for longest lifetime, even in MDF. Best price-performance ratio!

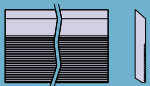

**Matrix - coating technology:**  
Unique coating for maximum lifetime requirements

- Tool life is on average 5 times longer compared to HSS
- Coating penetrates into the material
- Still significantly longer tool life after reshaping

 **TIGRA ist einer der führenden Lieferanten von Schneideinsätzen für rückenverzahnte Messerköpfe.**  
Unser umfassendes Programm an Blanketts beinhaltet:



**HSS:** das klassische Blankett für rückenverzahnte Messerköpfe:

- Hohe Qualität durch deutschen Stahl
- Präzisionsgeschliffene Verzahnung
- Exzellente Schleifeigenschaften
- Ab Lager verfügbar



**High Performance Steel:** die günstige Alternative zu HSS:

- Hohe Qualität durch deutschen Stahl
- Sehr gute Standzeiten in den meisten Anwendungen
- Günstiger als Standard-HSS
- Einfacher zu trennen als HSS
- Präzisionsgeschliffene Verzahnung



**Hartmetallbestückt:** Aufgelötetes Hartmetall wo immer die Standzeiten von HSS und High Performance Steel nicht ausreichen:

- Sehr lange Standzeit
- Hohe Härte
- Hervorragende Qualität



**SuperPac:** das Top-Blankett, das dank der hoch präzisen Verzahnung vielfach nachschleifbar ist. SuperPac ist in verschiedenen Hartmetallsorten erhältlich und garantiert längste Standzeiten, auch in MDF. Bestes Preis-Leistungsverhältnis!



**Matrix - coating technology:**  
Einzigartige Beschichtung für höchste Standwegansprüche

- Durchschnittlich 5-facher Standweg gegenüber HSS
- Beschichtung dringt in das Material ein
- Auch nach dem Schärfen noch deutlich längere Standwege

 **TIGRA est l'un des plus grands fournisseurs d'outils de coupe pour axes crantés.**  
Notre vaste gamme de plaquettes inclut:



**HSS:** la plaquette de coupe classique pour les porte-outils crantés a de nombreux atouts :

- Qualité élevée de l'acier d'origine allemande
- Crantage affilée pour haute précision
- Excellentes propriétés de rectification
- Disponible sur stock







**High Performance Steel** (acier à haute performance): l'alternative économique a HSS

- Qualité élevée de l'acier d'origine allemande
- Très résistante dans la majorité des applications
- Moins chère que le HSS standard
- Plus facile à couper que le HSS
- Crantage affilée pour haute précision



**Outils rapportés en carbure brasé** là où la durée de coupe des HSS et High Performance Steel n'est pas suffisante :

- Très grande longévité
- Dureté élevée
- Qualité supérieure

-  **Knives for back corrugated cutterheads - TIGRA materials and their applications**
-  **Messer für rückenverzahnte Messerköpfe - TIGRA Materialien und ihre Anwendungen**
-  **Couteaux pour outils crantés - Les matériaux TIGRA et leurs applications**
-  **Coltelli per teste con zigrinatura - I materiali TIGRA e le loro applicazioni**
-  **Cuchillas corrugadas - Materiales TIGRA y su aplicación**

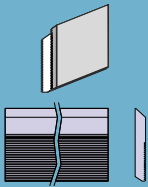

**SuperPac:**

le nec plus ultra de la plaquette de coupe que la précision de son crantage permet de réaffûter de multiples fois. SuperPac est également disponible en plusieurs qualités de métal différentes et garantit des durées de coupe plus longues, même sur des MDF. Le mieux rapport qualité-prix!

**Matrix - coating technology:** Un revêtement unique pour une tenue d'outil inégalée

- En moyenne la tenue d'outil est multipliée par 5 par rapport au HSS
- Le revêtement pénètre le matériau
- Des tenues d'outil nettement plus longues, même après l'affutage



**TIGRA è uno dei fornitori leader di inserti per teste portafrese a coltelli dentati sul lato interno. Il nostro ampio programma di inserti greggi comprende:**

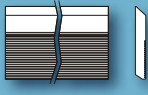

**HSS:** l'inserto classico per teste con zigrinatura

- Alta qualità grazie all'acciaio tedesco
- Zigrinatura rettificata per tolleranze elevate
- Eccellenti proprietà di rettifica
- Disponibili per pronta consegna

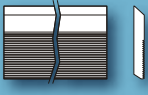

**High Performance Steel:** l'alternativa economica al HSS

- Alta qualità grazie all'acciaio tedesco
- Lunga durata per gran parte delle applicazioni
- Maggiore convenienza del prezzo rispetto ai prodotti standard HSS
- Maggiore semplicità di troncatura rispetto ai prodotti HSS
- Zigrinatura rettificata per tolleranze elevate



**TCT (riportato metallo duro):** metallo duro saldato per applicazioni in cui la durata di HSS e di High Performance Steel non è sufficiente:

- Elevatissima durata
- Elevata durezza
- Massima qualità

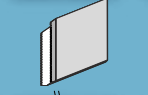

**SuperPac:** l'inserto greggio top più volte riaffilabile grazie alla dentatura altamente precisa.

SuperPac è disponibile in diversi tipi di metallo duro e garantisce la massima durata, anche in MDF. Migliore rapporto qualità/prezzo!



**Matrix - coating technology:** Rivestimento unico per esigenze di massima durata

- Una durata media 5 volte più lunga rispetto al HSS
- Il rivestimento penetra nel materiale
- Anche dopo la riaffilature la durata è considerevolmente più lunga



**TIGRA es uno de los principales fabricantes de insertos cortantes para cuchillas de lomo dentado. Nuestro exhaustivo programa de piezas en bruto comprende:**



**HSS:** La pieza en bruto clásica para cuchillas de lomo dentado:

- Mejor calidad gracias al empleo de acero alemán
- Mayor tolerancia y dentado sumamente preciso
- Excelentes propiedades de rectificado
- Disponible de almacén



**High Performance Steel:** Nuestra alternativa económica a HSS

- Mejor calidad gracias al empleo de acero alemán
- Vida útil muy buena en la mayor parte de las aplicaciones
- Más económico que el acero HSS estándar
- Más fácil de cortar que el acero HSS
- Mayor tolerancia y dentado sumamente preciso



**Con dotación de metal duro (TCT):** Metal duro fijado por soldadura para aplicaciones que requieran una vida útil más prolongada que la que ofrecen las calidades HSS y High Performance Steel:

- Vida útil muy prolongada
- Máxima dureza
- Óptima calidad

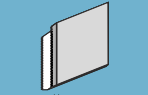

**SuperPac:** La pieza en bruto de alta calidad y dentado preciso que admite múltiple rectificado.



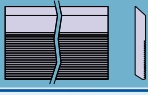

SuperPac se ofrece en diversos tipos de metal duro y avala una prolongada vida útil, también en MDF. La mejor relación precio-rendimiento.







**Matrix - coating technology:** Recubrimiento exclusivo para un máximo rendimiento

- Ratio de vida de la herramienta 5 veces superior al HSS
- Recubrimiento se adhiere al material
- Duracion de vida significativamente superior después de reafilado



-  Knives for back corrugated cutterheads
-  Messer für rückenverzahnte Messerköpfe
-  Couteaux pour outils crantés
-  Coltelli per teste zigrinata
-  Cuchillas corrugadas



-  Matrix - unique benefits by using TIGRA's special layered knives
-  Matrix - einzigartige Vorteile dank TIGRA's spezial-beschichteter Messer
-  Matrix - avantages uniques grâce aux couteaux TIGRA pourvus d'un revêtement spécial
-  Matrix - vantaggi straordinari utilizzando coltelli TIGRA speciali stratificati
-  Matrix - beneficios únicos utilizando cuchillos especiales capas de TIGRA

 **Highest lifetime = lowest cost**

Money is earned on the cutting edge: long lifetime leads to lowest cost per cut length, less machine downtimes, less changeovers, more accurate and repetitive profiles. Matrix knives offer 4-6 times higher lifetime when working wood, cutting not only wood but also your total costs.

**Ultra-thin layer = sharpest cut**

Different from many coatings (PCD, CVD, ...), Matrix coated knives have a layer of only 1/1000 mm, leaving the cutting edge extremely sharp instead of rounding them.

**Non-structured layer = minimum friction**

The special mix of elements and the special way of coating result in a surface with an extremely low friction coefficient – for better chip flow, lower resin adherence as well as faster & smoother cutting.

**Less energy, less waste = going green**

The long lifetime highly reduces waste of natural resources and polluting recycling processes. Thanks to the low friction, the tool itself uses less energy on the machine as well.

**Many resharpenings = even higher savings**

Matrix coated knives can be resharpened, multiplying your savings!

 **Höchste Lebensdauer = geringe Kosten**

Das Geld wird an der Schneidkante verdient: eine lange Lebensdauer bedeutet niedrigste Kosten pro Schnittlänge, geringere Stillstandszeiten, weniger Umstellungen, und bringt genauere, repetitive Profile. Matrix-Messer bieten 4-6 mal höhere Standwege in der Holzbearbeitung, beschneiden sowohl Holz als auch Ihre Gesamtkosten.

**Ultradünne Beschichtung = schärfster Schnitt**

Anders als bei vielen Beschichtungen (PKD, CVD, ...) haben Matrix-Messer eine Beschichtungsstärke von nur 1/1000 mm, wobei die Schneide extrem scharf bleibt und keine Rundungen entstehen.

**Nichtstrukturierte Schicht = minimale Reibung**

Die spezielle Mischung von Komponenten und die spezielle Art der Beschichtung führen zu einer Oberfläche mit einem extrem niedrigen Reibungskoeffizienten - zur besseren Spanabführung, geringerem Verkleben mit Harz sowie einem schnellen und gleichmäßigem Schneiden.

**Geringerer Energieaufwand, weniger Abfall = Going Green**

Die lange Lebensdauer reduziert die Verschwendung natürlicher Ressourcen und Umwelt verschmutzende Recyclingverfahren. Dank der geringen Reibung benötigt das Werkzeug wie die gesamte Maschine auch weniger Energie.

**Viele Nachschliffe = noch höhere Einsparungen**

Matrix-Messer können nachgeschliffen werden, was zur Multiplikation ihrer Einsparungen führt!

 **Durée de vie maximale = minimisation des coûts**

Les économies sont réalisées grâce à l'arête de coupe : une longue durée de vie signifie des coûts minimaux par longueur de coupe, des durées d'immobilisation plus courtes, moins de changements, et des profils plus précis et récurrents. Les couteaux Matrix proposent une tenue d'outil supérieure de 4 à 6 fois, coupent du bois, mais s'attaquent aussi vos coûts globaux.

**Revêtement ultra fin = coupe ultra vive**

Contrairement à nombre d'autres revêtements (PCD, CVD, ...), l'épaisseur de couche des couteaux Matrix est de 1/1000 mm seulement; l'arête reste extrêmement vive et il n'y a pas d'arrondis.

**Couche non structurée = friction minimale**

Le mélange spécial de composants et la technique particulière utilisée pour le revêtement font que l'on obtient une surface avec un coefficient de friction extrêmement bas - pour une meilleure évacuation des copeaux, une adhérence minimale à la résine et une coupe rapide et égale.

**Moins de dépenses énergétiques, moins de déchets = Going Green**





La longue durée de vie réduit les gaspillages des ressources naturelles et les procédés de recyclage polluant l'environnement. Grâce à la faible friction, les outils et toute la machine consomment moins d'énergie.

**Beaucoup d'affutages = davantage d'économies**





Les couteaux Matrix peuvent être affûtés, ce qui augmente vos économies.





-  Knives for back corrugated cutterheads
-  Messer für rückenverzahnte Messerköpfe
-  Couteaux pour outils crantés
-  Coltelli per teste zigrinata
-  Cuchillas corrugadas



-  Matrix - unique benefits by using TIGRA's special layered knives
-  Matrix - einzigartige Vorteile dank TIGRA's spezial-beschichteter Messer
-  Matrix - avantages uniques grâce aux couteaux TIGRA pourvus d'un revêtement spécial
-  Matrix - vantaggi straordinari utilizzando coltelli TIGRA speciali stratificati
-  Matrix - beneficios únicos utilizando cuchillos especiales capas de TIGRA

 **Massima durata = minor costo**

Il guadagno c'è sul filo della lama: una lunga durata porta a un costo più basso per lunghezza di taglio, tempi di fermo macchina ridotti, meno cambi di coltelli, profili più accurati e ripetitivi. Sulla lavorazione del legno i coltelli Matrix offrono una durata di 4 a 6 volte superiore ai coltelli normali. Tagliano non solo il legno ma anche i costi.

**Strato ultra-sottile = filo tagliente**

Diverso da molti rivestimenti (PCD, CVD, ...), il rivestimento dei coltelli Matrix hanno uno strato di solo 1/1000 mm, lasciando il filo della lama molto tagliente, senza arrotondarlo.

**Strato non strutturato = minimo attrito**

La miscela speciale di componenti ed il particolare rivestimento porta a una superficie con un coefficiente di attrito estremamente basso - per un miglior smaltimento del truciolo, un' inferiore adesione della resina e un taglio più veloce e agevole.

**Meno spreco d'energia, meno rifiuti = ecologia**

La lunga durata riduce al minimo lo spreco delle risorse naturali e la necessità di riciclaggi inquinanti. Grazie al basso coefficiente di attrito, l'utensile e la macchina utilizza meno energia.

**Molte riaffilature = risparmi ancora più elevati**

I coltelli Matrix possono essere riaffilati più volte, moltiplicando i tuoi risparmi!

 **Mayor vida útil = menor coste**

El dinero se gana en la vanguardia: larga vida conduce a menor costo por longitud de corte, menos tiempos de parada de la máquina, menos cambios de más perfiles precisos y repetitivos. Cuchillos Matrix ofrecen de por vida 6.4 veces mayor cuando se trabaja la madera, de corte no sólo la madera sino también sus costos totales.

**Capa ultra delgada = más aguda corte**

A diferencia de muchas capas (PCD, enfermedades cardiovasculares, ...), cuchillos Matrix cubierta tienen una capa de sólo 1 / 1000 mm, dejando el borde de corte muy afilados en lugar de redondeo ellos.

**Capa no estructred = fricción mínima**





La mezcla especial de elementos y la forma especial del resultado de recubrimiento en una superficie con un coeficiente de fricción extremadamente bajo - para un mejor flujo de la viruta, menor adherencia de la resina, así como el corte más rápido y más suave.

**Menos energía, menos residuos = verde que va**

El tiempo de vida muy larga reduce el desperdicio de los recursos naturales y contaminando los procesos de reciclado. Gracias a la baja fricción, la propia herramienta utiliza menos energía en el equipo también.

**Muchos resharpenings = ahorro aún mayor**

Cuchillos Matrix recubiertos puede volver a afilar, multiplicar sus ahorros!



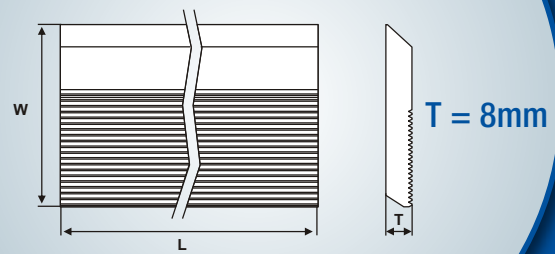

-  Back corrugated blanks
-  Rückenverzahnte Blanketts
-  Fers crantés
-  Placchette con zigrinatura
-  Cuchillas corrugadas



HSS/  
High Performance Steel/  
Matrix



L	W	T	HSS	High Performance Steel	Matrix coating technology
mm	mm	mm			
40.0	40	8.0	030289	103456	120287
50.0	40	8.0	030290	103457	120269
60.0	40	8.0	030291	103458	120270
70.0	40	8.0	030292	103459	120271
80.0	40	8.0	030293	103460	120272
90.0	40	8.0	030294	103461	120273
100.0	40	8.0	030295	103462	120274
110.0	40	8.0	047397	103463	120275
120.0	40	8.0	030296	103464	120276
130.0	40	8.0	030297	103465	120277
150.0	40	8.0	030298	103466	120278
170.0	40	8.0	030299	103467	120279
180.0	40	8.0	030300	103468	120280
200.0	40	8.0	030301	103469	120281
210.0	40	8.0	030302	103470	120282
230.0	40	8.0	030303	103471	120283
260.0	40	8.0	030304	103472	120284
650.0	40	8.0	030306	103473	120285
40.0	50	8.0	030307	103474	120288
50.0	50	8.0	030308	103475	120289
60.0	50	8.0	030309	103476	120290
70.0	50	8.0	030310	103477	120291
80.0	50	8.0	030311	103478	120292
90.0	50	8.0	030312	103479	120293
100.0	50	8.0	030313	103480	120294
110.0	50	8.0	047398	103481	120295
120.0	50	8.0	030314	103482	120296
130.0	50	8.0	030315	103483	120297
150.0	50	8.0	030316	103484	120298
170.0	50	8.0	030317	103485	120299
180.0	50	8.0	030318	103486	120300
200.0	50	8.0	030319	103488	120301
210.0	50	8.0	030320	103489	120302
230.0	50	8.0	030321	103490	120303
260.0	50	8.0	030322	103491	120304
650.0	50	8.0	030324	103492	120305



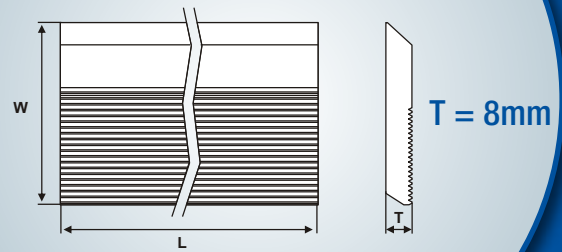

-  Back corrugated blanks
-  Rückenverzahnte Blanketts
-  Fers crantés
-  Placchette con zigrinatura
-  Cuchillas corrugadas



HSS/  
High Performance Steel/  
Matrix



L	W	T	HSS	High Performance Steel	Matrix coating technology
mm	mm	mm			
40.0	60	8.0	030326	103493	120310
50.0	60	8.0	030327	103494	120311
60.0	60	8.0	030328	103495	120312
70.0	60	8.0	030329	103496	120313
80.0	60	8.0	030330	103497	120314
90.0	60	8.0	030331	103498	120315
100.0	60	8.0	030332	103499	120316
110.0	60	8.0	047399	103500	120317
120.0	60	8.0	030333	103501	120318
130.0	60	8.0	030334	103502	120319
150.0	60	8.0	030335	103503	120320
170.0	60	8.0	030336	103504	120321
180.0	60	8.0	030337	103505	120322
200.0	60	8.0	030338	103506	120323
210.0	60	8.0	030339	103507	120324
230.0	60	8.0	030340	103508	120325
260.0	60	8.0	030341	103509	120326
650.0	60	8.0	030344	103510	120327
40.0	70	8.0	030345	103511	120328
50.0	70	8.0	030346	103512	120329
60.0	70	8.0	030347	103513	120330
70.0	70	8.0	030348	103514	120331
80.0	70	8.0	030349	103515	120332
90.0	70	8.0	030350	103516	120333
100.0	70	8.0	030351	103517	120334
110.0	70	8.0	047400	103518	120335
120.0	70	8.0	030352	103519	120336
130.0	70	8.0	030353	103521	120337
150.0	70	8.0	030354	103522	120338
170.0	70	8.0	030355	103523	120339
180.0	70	8.0	030356	103524	120340
200.0	70	8.0	030357	103525	120341
210.0	70	8.0	030358	103526	120342
230.0	70	8.0	030359	103527	120343
260.0	70	8.0	030360	103528	120344
650.0	70	8.0	030362	103529	120345



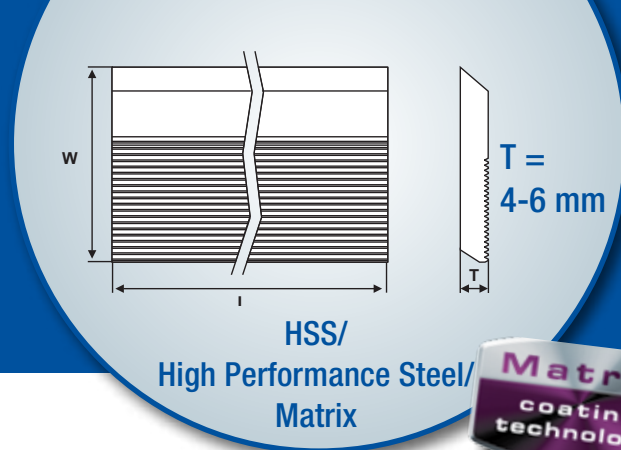

-  Back corrugated blanks
-  Rückenverzahnte Blanketts
-  Fers crantés
-  Placchette con zigrinatura
-  Cuchillas corrugadas



L	W	T	HSS	High Performance Steel	Matrix coating technology
mm	mm	mm			
650.0	30	4.0	104735	122085	122093

L	W	T	HSS	High Performance Steel	Matrix coating technology
mm	mm	mm			
650.0	27	5.0	108483	108504	120479
650.0	38	5.0	108522	108542	120499
650.0	45	5.0	108562	108584	120519
650.0	50	5.0	108604	108624	120539



L	W	T	HSS	High Performance Steel	Matrix coating technology
mm	mm	mm			
650.0	30	6.0	122082	122086	122094
650.0	40	6.0	051029	122087	122095
650.0	45	6.0	122083	122088	122096
650.0	50	6.0	043807	122089	122097
650.0	60	6.0	043808	122090	122098
650.0	70	6.0	051030	122091	122099

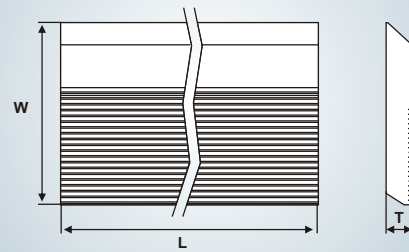

-  Back corrugated blanks
-  Rückenverzahnte Blanketts
-  Fers crantés
-  Placchette con zigrinatura
-  Cuchillas corrugadas







HSS/ Matrix/  
High Performance Steel  
inch



L inch	W inch	T inch	HSS (High Speed Steel)		Matrix coating technology
			 with chamfer	 flat bottom	 flat bottom
25	1 1/4	5/16	046364	101054	120583
25	1 1/2	5/16	046365	101055	120584
25	1 3/4	5/16	046366	101056	120585
25	2	5/16	046367	101057	120586
25	2 1/4	5/16	046368	101058	120587
25	2 1/2	5/16	046369	101059	120588
25	2 3/4	5/16	046370	101060	120589
25	3	5/16	046371	101061	120590
25	1 1/4	1/4	046372	101062	120591
25	1 1/2	1/4	046373	101063	120592
25	1 3/4	1/4	046374	101064	120593
25	2	1/4	046375	101065	120594
25	2 1/4	1/4	046376	101066	120595
25	2 1/2	1/4	046377	101067	120596
25	1 3/4	3/16	046378	101068	120597
25	2	3/16	046379	101069	120598



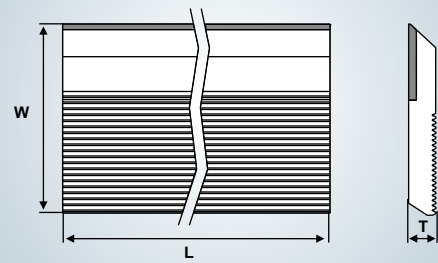

L inch	W inch	T inch	High Performance Steel	
			 with chamfer	 flat bottom
25	1 1/4	5/16	103531	103547
25	1 1/2	5/16	103532	103548
25	1 3/4	5/16	103533	103549
25	2	5/16	103534	103550
25	2 1/4	5/16	103535	103551
25	2 1/2	5/16	103536	103552
25	2 3/4	5/16	103537	103553
25	3	5/16	103538	103554
25	1 1/4	1/4	103539	103555
25	1 1/2	1/4	103540	103556
25	1 3/4	1/4	103541	103557
25	2	1/4	103542	103558
25	2 1/4	1/4	103543	103559
25	2 1/2	1/4	103544	103560
25	1 3/4	3/16	103545	103561
25	2	3/16	103546	103562

-  Back corrugated blanks
-  Rückenverzahnte Blanketts
-  Fers crantés
-  Placchette con zigrinatura
-  Cuchillas corrugadas



T.C.T.

L mm	W mm	T mm	Inlay 14 mm	Inlay 20 mm	Inlay 25 mm
40.0	40.0	10.0	103230	103249	
60.0	40.0	10.0	103231	103250	
80.0	40.0	10.0	103232	103251	
100.0	40.0	10.0	103233	103252	
130.0	40.0	10.0	103234	103253	
150.0	40.0	10.0	103235	103254	
180.0	40.0	10.0	103236	103255	
200.0	40.0	10.0	103237	103256	
230.0	40.0	10.0	103238	103257	
260.0	40.0	10.0	103239	103258	
310.0	40.0	10.0	103240	103259	
640.0	40.0	10.0	103241	103260	
40.0	50.0	10.0	103242	030254	
60.0	50.0	10.0	030255	103261	
80.0	50.0	10.0	030256	103262	
100.0	50.0	10.0	030257	103263	
130.0	50.0	10.0	030258	103264	
150.0	50.0	10.0	103243	103265	
180.0	50.0	10.0	030260	103266	
200.0	50.0	10.0	103244	103267	
230.0	50.0	10.0	103245	103268	
260.0	50.0	10.0	030262	103269	
310.0	50.0	10.0	103246	103270	
560.0	50.0	10.0	103247	103271	
640.0	50.0	10.0	103248	103272	030265

-  Back corrugated blanks
-  Rückenverzahnte Blanketts
-  Fers crantés
-  Placchette con zigrinatura
-  Cuchillas corrugadas

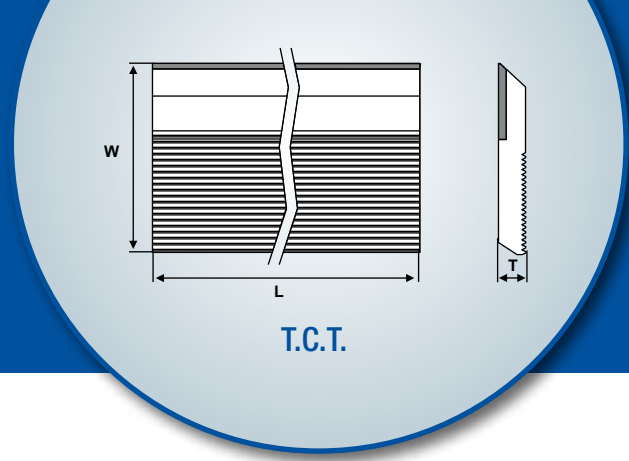

T.C.T.

L mm	W mm	T mm	Inlay 20 mm	Inlay 25 mm	Inlay 30 mm	Inlay 35 mm
40.0	60.0	10.0	030267	103300	114867	114868
60.0	60.0	10.0	030268	103301	103797	109128
80.0	60.0	10.0	103273	030269	109133	109129
100.0	60.0	10.0	103274	030270	109134	109130
120.0	60.0	10.0	112340	109479	114865	114866
130.0	60.0	10.0	103275	030271	109135	109131
150.0	60.0	10.0	030272	103302	114869	114870
180.0	60.0	10.0	030273	103303	109136	109132
200.0	60.0	10.0	103296	103304	114871	114872
230.0	60.0	10.0	103297	103305	109137	109138
260.0	60.0	10.0	030275	103306	114873	105299
310.0	60.0	10.0	103298	103307	114874	114875
560.0	60.0	10.0	103299	103308	114876	114877
640.0	60.0	10.0	030277	103309	114878	108848
60.0	70.0	10.0			109735	
80.0	70.0	10.0			030280	
100.0	70.0	10.0			030281	
640.0	70.0	10.0			114879	108849



 TIGRA SuperPac

 TIGRA SuperPac

 TIGRA SuperPac

 TIGRA SuperPac

 TIGRA SuperPac

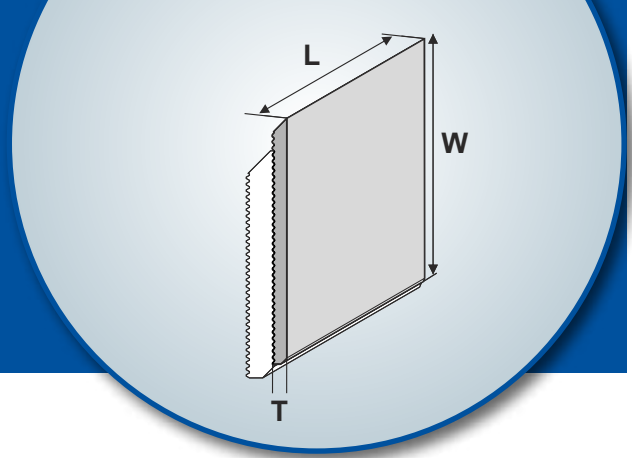

L mm	W mm	T mm	T10MG Standard	T04F Standard	T03SMG Special	L mm	W mm	T mm	Backing plate Stützplatte
40	38	3.2	043933	024082	024080	40	35	7.1	024090
50	38	3.2	043934	043924	043925	50	35	7.1	043957
60	38	3.2	043935	024115	024113	60	35	7.1	024123
80	38	3.2	043936	024148	024146	80	35	7.1	024156
100	38	3.2	043937	023949	023947	100	35	7.1	023957
120	38	3.2	043938	023982	023980	120	35	7.1	023990
130	38	3.2	043939	024016	024014	130	35	7.1	024024
150	38	3.2	043940	024049	024047	150	35	7.1	024057
170	38	3.2	043962	043961	043960	170	35	7.1	045837
180	38	3.2	113497			180	35	7.1	113484
200	38	3.2	113498			200	35	7.1	113485
210	38	3.2	113499			210	35	7.1	113486
230	38	3.2	113500			230	35	7.1	113487
310	38	3.2	113501			310	35	7.1	112229
330	38	3.2	113502			330	35	7.1	113481
40	50	3.2	043941	024093	024091	40	47	7.1	024101
50	50	3.2	043942	043927	043928	50	47	7.1	043958
60	50	3.2	043943	024126	024124	60	47	7.1	024134
80	50	3.2	043944	024159	024157	80	47	7.1	024167
100	50	3.2	043945	023960	023985	100	47	7.1	023968
120	50	3.2	043946	023993	023991	120	47	7.1	024001
130	50	3.2	043947	024027	024025	130	47	7.1	024035
150	50	3.2	043948	024060	024058	150	47	7.1	024068
170	50	3.2	043966	043965	043964	170	47	7.1	045838
180	50	3.2	113503			180	47	7.1	113488
200	50	3.2	113504			200	47	7.1	113489
210	50	3.2	113505			210	47	7.1	113490
230	50	3.2	113506			230	47	7.1	113491
310	50	3.2	113507			310	47	7.1	112230
330	50	3.2	113508			330	47	7.1	113482

 TIGRA SuperPac

 TIGRA SuperPac

 TIGRA SuperPac

 TIGRA SuperPac

 TIGRA SuperPac

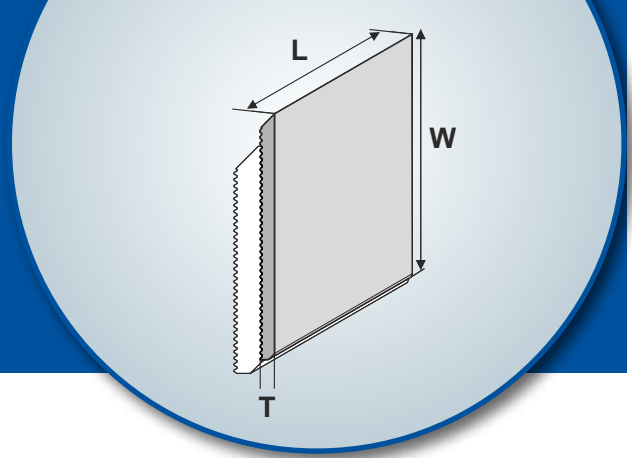





L mm	W mm	T mm	T10MG Standard	T04F Standard	T03SMG Special	L mm	W mm	T mm	Backing plate Stützplatte
40	60	3.2	043949	024104	024102	40	57	7.1	024112
50	60	3.2	043950	043931	043932	50	57	7.1	043959
60	60	3.2	043951	024137	024135	60	57	7.1	024145
80	60	3.2	043952	024170	024168	80	57	7.1	024178
100	60	3.2	043953	023971	023969	100	57	7.1	023979
120	60	3.2	043954	024004	024002	120	57	7.1	024012
130	60	3.2	043955	024038	024036	130	57	7.1	024046
150	60	3.2	043956	024071	024069	150	57	7.1	024079
170	60	3.2	043970	043969	043968	170	57	7.1	045839
180	60	3.2	113509			180	57	7.1	113493
200	60	3.2	113510			200	57	7.1	113494
210	60	3.2	113511			210	57	7.1	113495
230	60	3.2	113512			230	57	7.1	113496
310	60	3.2	113513			310	57	7.1	112231
330	60	3.2	113514			330	57	7.1	113483











**Tools cut better  
with TIGRA**











-  **Rods**
-  **Rundstäbe**
-  **Barreaux cylindriques**
-  **Cilindri**
-  **Barras redondas**





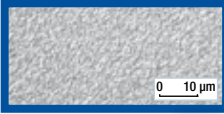
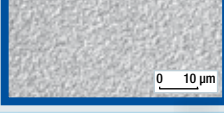





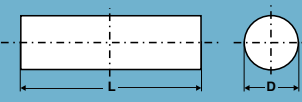





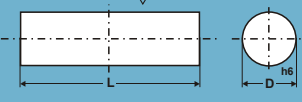

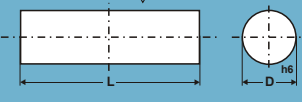

-  **Rods - TIGRA carbide grades and their applications – Technical Data**
-  **Rundstäbe - TIGRA Hartmetallsorten und ihre Anwendungen – Technische Daten**
-  **Barreaux cylindriques - Les nuances de carbures TIGRA et leurs applications – Caractéristiques techniques**
-  **Cilindri - I tipi di metallo duro TIGRA e le loro applicazioni – Dati tecnici**
-  **Barras redondas - Calidades de metal duro TIGRA y sus aplicaciones – Datos técnicos**

 TIGRA grade  TIGRA - Sorte  Nuance TIGRA  Tipo TIGRA  Calidad TIGRA	Binder Binder Liant Legante Composicion	Hardness Härte Dureté Durezza Dureza		Bending strength Biegebruchfestigkeit Resistance à la flexion Resistenza flessionale Resistencia a la flexión		Toughness Zähigkeit Ténacité Tenacità Tenacidad
		%	HV 10	HRA ±0.2	N/mm <sup>2</sup>	
<b>T06CR</b> ISO: K01 USA: C4 +	3.0	1950	94.0	2300	334.000	8.2
<b>T06MG</b> ISO: K01-K20 USA: C3 ++	6.0	1800	93.3	2700	392.000	8.2
<b>Standard T10MG</b> ISO: K10-K40 USA: C3 +	10.0	1650	92.3	3600	522.000	9.4
<b>T12SMG</b> USA: C1 ++	12.0	1700	92.7	4000	580.000	9.2

 TIGRA grade  TIGRA - Sorte  Nuance TIGRA  Tipo TIGRA  Calidad TIGRA	Main usage Hauptanwendung Principal usage Main uso Uso principal	
<b>T06CR</b>	Highly abrasive materials like chipboard, for drilling and milling Stark abrasive Materialien wie Spanplatte, zum Bohren und Fräsen Matériaux très abrasifs comme panneau, pour forer et fraiser Materiali abrasivi come il truciolare, da forare e fresare Superabrasivo madera como aglomerados, para taladrado y fresado	
<b>T06MG</b>	Hard wood-based materials, plastics, graphite, aluminum Harte Materialien auf Holz-Basis, Kunststoffe, Graphit, Aluminium Matériaux à la base de bois, matériaux plastiques, graphite, aluminium Materiali duri legnosi, plastici, graffite, alluminio Materiales derivados de madera, plasticos, graphito, aluminio	
<b>T10MG</b>	Universal grade for wood and metal working Universalsorte für die Holz- und Metallbearbeitung Nuance universelle pour le travail du bois et des métaux Qualità universale per la lavorazione del legno e del metallo Grado universal para trabajos de madera y mecanica	
<b>T12SMG</b>	Very hard grade with high wear resistance for long lifetime Sehr harte und verschleißfeste Sorte für lange Standwege Nuance très dur résistant à l'usure pour une longue durée de vie Qualità molto dura con elevata resistenza all'usura per una lunga durata Calidad ultradura y resistente al desgaste para una prolongada vida útil	

-  **Rods**
-  **Rundstäbe**
-  **Barreaux cylindriques**
-  **Cilindri**
-  **Barras redondas**

	<ul style="list-style-type: none"> <li> <b>Rods - as sintered</b> mm</li> <li> <b>Rundstäbe - roh</b> mm</li> <li> <b>Barreaux cylindriques - brut</b> mm</li> <li> <b>Cilindri - grezzo</b> mm</li> <li> <b>Barras redondas - en bruto</b> mm</li> </ul>	<div style="background-color: #c00; color: white; border-radius: 10px; padding: 5px; display: inline-block;">152</div>
	<ul style="list-style-type: none"> <li> <b>Rods - ground</b> mm</li> <li> <b>Rundstäbe - geschliffen</b> mm</li> <li> <b>Barreaux cylindriques - affutée</b> mm</li> <li> <b>Cilindri - rettificato</b> mm</li> <li> <b>Barras redondas - afilado</b> mm</li> </ul>	<div style="background-color: #c00; color: white; border-radius: 10px; padding: 5px; display: inline-block;">153-156</div>
	<ul style="list-style-type: none"> <li> <b>Rods - ground</b> inch</li> <li> <b>Rundstäbe - geschliffen</b> inch</li> <li> <b>Barreaux cylindriques - affutée</b> inch</li> <li> <b>Cilindri - rettificato</b> inch</li> <li> <b>Barras redondas - afilado</b> inch</li> </ul>	<div style="background-color: #c00; color: white; border-radius: 10px; padding: 5px; display: inline-block;">157</div>

 Rods

 Rundstäbe

 Barreaux cylindriques

 Cilindri

 Barras redondas

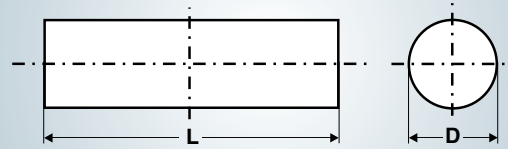

as sintered  
roh  
brut  
grezzo  
en bruto

D mm	L mm	T10MG	T06MG	T06CR	T12SMG
1.2	330	035472			
1.7	330	035473			
2.2	330	035474	036478	114889	
2.7	330	035475	036479	114890	
3.2	330	029686	032541	114891	053791
3.7	330	035476	036480	114892	
4.2	330	029688	032542	114893	053792
4.7	330	035477			
5.2	330	034420	036482	114894	053793
5.7	330	035478			
6.2	330	029690	032543	114895	053794
6.7	330	035479			
7.2	330	035480	036485	114896	053795
7.7	330	035481			
8.2	330	029692	032544	114897	053796
8.7	330	035482			
9.3	330	035483			
9.8	330	035484			
10.3	330	029694	053093	113457	053797
10.8	330	035485			
11.3	330	035486			
11.8	330	035488			
12.3	330	029696	053094	113456	053798
12.8	330	035490			
13.3	330	035492			102418

D mm	L mm	T10MG	T06MG	T06CR	T12SMG
14.3	330	029698	053095	114908	053799
14.8	330	035494			
15.3	330	035495			
16.3	330	029700	053096	113455	053800
16.8	330	035497			
17.3	330	035498			
18.3	330	029702	053097	114898	053801
18.8	330	036514			
19.3	330	035500			
20.3	330	029704	053098	114899	053802
22.3	330	035503	036503	114900	109909
23.3	330	035504	036504	114901	
24.3	330	035505			
25.3	330	029706	032551	114902	053803
25.8	330	036525			
26.3	330	035506	036506	114903	
27.3	330	036527			
28.3	330	035507	036507	114904	109910
29.3	330	036529			
30.3	330	035508	036508	114905	
31.3	330	036531			
32.3	330	035509	036509	114906	
35.5	330	036533	036532	114907	

Other grades and dimensions upon request.  
Andere Sorten und Abmessungen auf Anfrage.  
D'autres nuances et dimensions sur demande.  
Altri tipi e dimensioni a richiesta.  
Otras calidades y dimensiones bajo demanda.



-  Rods
-  Rundstäbe
-  Barreaux cylindriques
-  Cilindri
-  Barras redondas

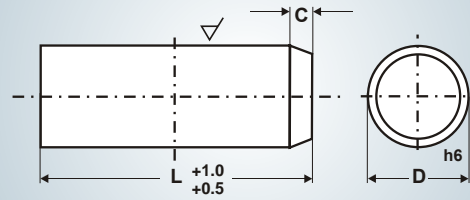

ground  
geschliffen  
affutée  
rettificato  
afilado

D mm	L mm	C mm	T10MG h6	T06MG h6	T06CR h6	T12SMG h6
1.0	330		035517			
1.5	100 330		036366 035518			
2.0	100 330		036368 035519			
2.5	50 100 330		049983 036370 035520			
3.0	38 43 50 330		053363 039162 034177 029708	100980 055446 055445 029707	114916 114915 114914 114910	109912
3.5	330		035521			
4.0	43 50 55 330		039161 034178 039104 029710	106821 034158 101012 029709	114917 114918 114919 114911	109913
4.5	330		035522			
5.0	43 50 330		052459 034179 034802	106780 034159 036541	114920 114921 114912	104207
5.5	330		035523			
6.0	46 50 55 60 70 330	0.4 0.4 0.4 0.4 0.4	102374 043244 039107 034180 043527 029712	106785 106787 101016 034160 106399 029711	114922 114923 114924 114925 114926 114913	101390
6.5	330		035524			
7.0	330		035525	036544	114927	109914
7.5	330		035526			

Other grades and dimensions upon request.  
Andere Sorten und Abmessungen auf Anfrage.  
D'autres nuances et dimensions sur demande.  
Altri tipi e dimensioni a richiesta.  
Otras calidades y dimensiones bajo demanda.



 Rods

 Rundstäbe

 Barreaux cylindriques

 Cilindri

 Barras redondas

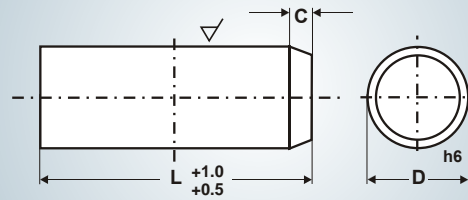

ground  
geschliffen  
affutée  
rettificato  
afilado

D mm	L mm	C mm	T10MG h6	T06MG h6	T06CR h6	T12SMG h6
8.0	50	0.6	045419	106788	114941	
	55	0.6	041602	106789	114942	
	56	0.6	102197	106790	114943	
	60	0.6	046522	102018	114944	
	70	0.6	038349	101017	114945	
	75	0.6	041481	101018	114946	
	80	0.6	034181	034161	114947	
	100	0.6	036392	036391	114948	
	330		029714	029713	114928	100702
8.5	330		035527			
9.0	330		035528			
9.5	330		035529			
10.0	65	0.6	102514	106791	114951	
	70	0.6	038350	101019	114953	
	75	0.6	038351	055813	114954	
	80	0.6	034182	106402	114955	
	90	0.6	052421	106792	114956	
	100	0.6	034183	036399	114957	
	110	0.6	111134			
330		029716	029715	114929	100701	
10.5	330		035530			
11.0	330		035531			
11.5	330		035532			
12.0	80	0.8	034184	053694	114958	
	90	0.8	038352	101020	114959	
	100	0.8	034185	034165	114960	
	110	0.8	052744	106794	114961	
	120	0.8	051331	106795	114962	
	155	0.8	106797	106796	114963	
	330		029718	029717	114930	100698
12.5	330		035533			
13.0	330		035534			

Other grades and dimensions upon request.  
Andere Sorten und Abmessungen auf Anfrage.  
D'autres nuances et dimensions sur demande.  
Altri tipi e dimensioni a richiesta.  
Otras calidades y dimensiones bajo demanda.

-  Rods
-  Rundstäbe
-  Barreaux cylindriques
-  Cilindri
-  Barras redondas

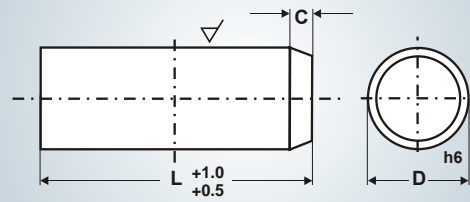

ground  
geschliffen  
affutée  
rettificato  
afilado

D mm	L mm	C mm	T10MG h6	T06MG h6	T06CR h6	T12SMG h6
14.0	90	0.8	041482	101022	114964	
	100	0.8	034186	034166	114965	
	110	0.8	038353	101023	114966	
	120	0.8	053659	106801	114967	
	330		029720	029719	114931	109915
14.5	330		035536			
15.0	330		035537			
16.0	80	0.8	052553	106412	114972	
	90	0.8	038354	101024	114973	
	93	0.8	106803	106802	114974	
	100	0.8	034187	034167	114975	
	110	0.8	038355	101025	114976	
	120	0.8	034188	034168	114977	
	130	0.8	053858	106805	114978	
	140	0.8	038356	101026	114979	
	150	0.8	043662	103951	114980	
	155	0.8	041603	106806	114981	
	170	0.8	052410	106807	114982	
	175	0.8	053515	106808	114983	
	180	0.8	111133			
	330		029722	029721	114932	103950
16.5	330		035539			
17.0	330		035540			
18.0	93	0.8	106809	106810	114984	
	100	0.8	034189	034169	114985	
	110	0.8	102817	106811	114986	
	115	0.8	038357	101027	114987	
	120	0.8	034190	034170	114988	
330		029724	029723	114933	109916	
18.5	330		036573			
19.0	330		035541			
20.0	100	1.0	034192	034172	114989	
	110	1.0	044472	106403	114990	
	115	1.0	038358	101028	114991	
	120	1.0	034193	034173	114992	
	125	1.0	100241	106812	114993	

Other grades and dimensions upon request.  
Andere Sorten und Abmessungen auf Anfrage.  
D'autres nuances et dimensions sur demande.  
Altri tipi e dimensioni a richiesta.  
Otras calidades y dimensiones bajo demanda.

 Rods

 Rundstäbe

 Barreaux cylindriques

 Cilindri

 Barras redondas

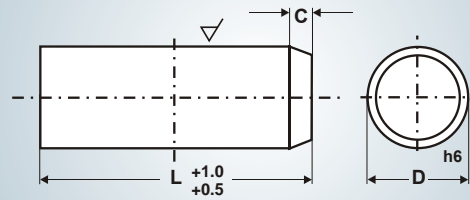

ground  
geschliffen  
affutée  
rettificato  
afilado

D mm	L mm	C mm	T10MG h6	T06MG h6	T06CR h6	T12SMG h6
20.0	130	1.0	106044	106813	114994	
	135	1.0	039115	054819	114995	
	140	1.0	038359	101029	114996	
	145	1.0	105702	106814	114997	
	150	1.0	034194	034174	114998	
	155	1.0	100073	106815	114999	
	170	1.0	055570	106816	115000	
	330			029726	029725	114934
20.5	330		036577			
21.0	330		035542			
22.0	330		035543	036562	114935	109918
23.0	330		035544			
23.5	330		036583			
24.0	330		035545			
25.0	110	1.0	102424	104306	115005	
	125	1.0	106818	106817	115006	
	155	1.0	102765	106819	115007	
	330		029728	029727	114936	109919
26.0	330		035546			
27.0	330		036587			
28.0	330		035547	036566	114937	109920
29.0	330		036589			
30.0	330		035548	036567	114938	
31.0	330		036591			
32.0	330		035549	036568	114939	
35.0	330		035552	036569	114940	

Other grades and dimensions upon request.  
Andere Sorten und Abmessungen auf Anfrage.  
D'autres nuances et dimensions sur demande.  
Altri tipi e dimensioni a richiesta.  
Otras calidades y dimensiones bajo demanda.

 Rods

 Rundstäbe

 Barreaux cylindriques

 Cilindri

 Barras redondas

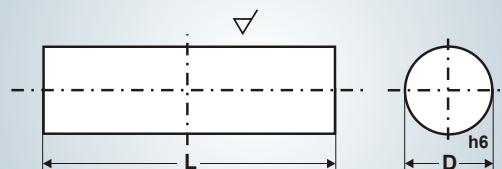

US style  
inch

Dia inch	L inch	T10MG h6	T06MG h6	T06CR h6
<b>1/8</b>	1 1/2	049465	054851	115022
	2	049466	054852	115023
	2 1/2	049467	054853	115024
	3	050160	054854	115025
	4	049632	054855	115026
	6	049469	054856	115027
	12 1/4	050139	054926	115008
<b>5/32</b>	3	049470	054857	115052
	12 1/4	050140	054927	115009
<b>3/16</b>	1 1/2	049471	054858	115028
	2	049472	054859	115029
	2 1/2	050165	054860	115030
	3	100251		
	12 1/4	050147	054929	115010
<b>7/32</b>	12 1/4	050148	054930	115011
<b>15/64</b>	12 1/4	050149	054931	115012
<b>1/4</b>	1 1/2	049474	054873	115031
	2	049475	054861	115032
	2 1/2	049476	053113	115033
	3	050169	053114	115034
	4	050170	054862	115035
	12 1/4	050150	054821	115013
<b>5/16</b>	2 1/2	054350		
	3 1/2	100287		
	4	100646		
	12 1/4	050151	054933	115014
<b>3/8</b>	2 1/2	049477	054863	115036
	3	049478	053115	115037
	4	049633	054864	115038
	6	049480	054865	115039
	12 1/4	050152	054934	115015
<b>7/16</b>	3	101122		
	6	101668		
	12 1/4	050153	054935	115016

Dia inch	L inch	T10MG h6	T06MG h6	T06CR h6
<b>1/2</b>	2	050175	054866	115040
	2 1/2	050176	054867	115041
	3	049481	053116	115042
	3 1/2	045137	053117	115043
	4	049482	054868	115044
	6	101183		
	12 1/4	050154	054936	115017
<b>9/16</b>	12 1/4	050155	054937	115018
<b>5/8</b>	3	049483	054869	115045
	3 1/2	050180	054870	115046
	4	049484	053118	115047
	5	050182	054871	115048
	12 1/4	050156	054939	115019
<b>3/4</b>	4	050183	053119	115049
	5	054148		
	6	055232		
	12 1/4	050157	054822	115020
<b>1</b>	5	050184	054872	115050
	6	100224		
	12 1/4	050158	054824	115021

Other grades and dimensions upon request.  
Andere Sorten und Abmessungen auf Anfrage.  
D'autres nuances et dimensions sur demande.  
Altri tipi e dimensioni a richiesta.  
Otras calidades y dimensiones bajo demanda.





**Tools cut better  
with TIGRA**



-  PCD - Polycrystalline diamond
-  PKD - Polykristalliner Diamant
-  PCD - Diamant policristallin
-  PCD - Diamante policristallino
-  PCD - Diamante policristalino













-  **TIGRA PCD grades and their applications** – Grain sizes and binder content
-  **TIGRA PKD-Sorten und ihre Anwendungen** – Korngrößen und Bindergehalt
-  **Les nuances PCD TIGRA et leurs applications** – Grosseur du grain et teneur en liant
-  **I tipi di PCD-TIGRA e le loro applicazioni** – Grossezza del grano e quota di legante
-  **Aplicaciones de las calidades TIGRA PCD** – Tamaños de grano y proporción de ligante

 TIGRA grade  TIGRA Sorte  Nuance TIGRA  Tipo TIGRA  Calidad TIGRA	Binder Binder Liant Legante Composición		Grain size Korngröße Grosseur du grain Grossezza del grano Tamaño del grano
			µm
<b>FS</b>	Standard	2 - 4	
<b>FX</b>	Special	2 - 4	
<b>FU</b>	Ultrahard	2 - 4	
<b>MS</b>	Standard	8 - 10	
<b>MX</b>	Special	8 - 10	
<b>MU</b>	Ultrahard	8 - 10	
<b>CS</b>	Standard	20 - 35	
<b>CX</b>	Special	20 - 35	
<b>CU</b>	Ultrahard	20 - 35	











-  **TIGRA PCD grades and their applications** – Grain sizes and binder content
-  **TIGRA PKD-Sorten und ihre Anwendungen** – Korngrößen und Bindergehalt
-  **Les nuances PCD TIGRA et leurs applications** – Grosseur du grain et teneur en liant
-  **I tipi di PCD-TIGRA e le loro applicazioni** – Grossezza del grano e quota di legante
-  **Aplicaciones de las calidades TIGRA PCD** – Tamaños de grano y proporción de ligante

-  Grain sizes „F“, „M“ and „C“ (F=Fine, M=Medium, C=Coarse)
-  Korngrößen „F“, „M“ und „C“ (F=Fein, M=Medium, C=Grob)
-  Grosseurs du grain „F“, „M“ et „C“ (F=Fine, M=Moyenne, C=Grosse)
-  Grossezza del grano „F“, „M“ e „C“ (F=Fino, M=Medio, C=Grosso)
-  Tamaño del grano „F“, „M“ y „C“ (F=Fina, M=Media, C=Grosera)

 TIGRA grade  TIGRA Sorte  Nuance TIGRA  Tipo TIGRA  Calidad TIGRA	Grain size Korngröße Grosseur du grain Grossezza del grano Tamaño del grano	Main usage Hauptanwendung Principal usage Main uso Uso principal
<b>µm</b>		
<b>FS, FX, FU</b>	2	Pointed angles of the cutting edge Spitze Winkel der Schneidkante Angles pointus de l'arête Angoli del taglio a punta Ángulo agudo del filo cortante
<b>MS, MX, MU</b>	10	Medial angles of the cutting edge Mittlere Winkel der Schneidkante Angles médians de l'arête Angoli del taglio medi Ángulo medio del filo cortante
<b>CS, CX, CU</b>	25	Blunt up to negative angles of the cutting edge Stumpfe bis negative Winkel der Schneidkante Angles émoussés à négatifs de l'arête Angoli del taglio ottusi fino ad angoli negativi Ángulo romo o negativo del filo cortante

-  **TIGRA PCD grades and their applications – Grain sizes and binder content**
-  **TIGRA PKD-Sorten und ihre Anwendungen – Korngrößen und Bindergehalt**
-  **Les nuances PCD TIGRA et leurs applications – Grosseur du grain et teneur en liant**
-  **I tipi di PCD-TIGRA e le loro applicazioni – Grossezza del grano e quota di legante**
-  **Aplicaciones de las calidades TIGRA PCD – Tamaños de grano y proporción de ligante**





-  **Binder „S“, „X“ and „U“**
-  **Binder „S“, „X“ und „U“**
-  **Liant „S“, „X“ et „U“**
-  **Legante „S“, „X“ e „U“**
-  **Composición „S“, „X“ y „U“**

 TIGRA grade  TIGRA Sorte  Nuance TIGRA  Tipo TIGRA  Calidad TIGRA	Binder Binder Liant Legante Composición	Features Eigenschaften Propriétés Proprietà Propiedades	Recommendations Anwendungsempfehlungen Recommandations d'application Consigli per l'uso Campos de aplicación recomendados
<b>FS, MS, CS</b>	<b>Standard</b>	Very long tool life, good cutting edge	Standard PCD tools for working chipboard, MDF, wood.
	<b>Standard</b>	Sehr lange Standwege, gute Schneidkante	Standard-PKD-Werkzeuge zur Bearbeitung von Spanplatte, MDF, Holz.
	<b>Standard</b>	Très longue durée de vie, bonne arête	Outils PCD standards pour l'usinage des panneaux de particules, MDF, bois.
	<b>Standard</b>	Lunghissima durata, buon taglio	Utensili in PCD standard per la lavorazione di truciolare, MDF, Legno.
	<b>Standard</b>	Vida útil muy prolongada, excelente filo cortante	Herramienta PCD estándar para el mecanizado de madera prensada, MDF, madera.
<b>FX, MX, CX</b>	<b>Special:</b> reduced PCD content, mixed binder for breakage and heat stability	Very good heat resistance	Standard PCD tools, Aluminium: FX: ≤ 6% Si, MX: 6-12% Si, CX: 12-20% Si
	<b>Spezial:</b> reduzierter PKD-Gehalt, Mischbinder für Bruch- und Wärmestabilität	Sehr gute Wärmebeständigkeit	Standard-PKD-Werkzeuge, Aluminium: FX: ≤ 6% Si, MX: 6-12% Si, CX: 12-20% Si
	<b>Spécial:</b> teneur en PCD réduite, liant mixte pour stabilité à la rupture et à la chaleur	Très bonne résistance à la chaleur	Outils PCD standards, Aluminium: FX: ≤ 6% de Si, MX: 6-12% de Si, CX: 12-20% de Si
	<b>Speciale:</b> quota di PCD ridotto, legante particolare per migliorare la resistenza al calore e alla rottura.	Resistenza al calore molto buona	Utensili in PCD standard Alluminio: FX: ≤ 6% Si, MX: 6-12 Si%, CX: 12-20% Si
	<b>Especial:</b> menor contenido de PKD, ligantes mixtos para estabilidad contra la rotura y estabilidad térmica	Excelente resistencia térmica.	Herramientas PCD, estándar Aluminio: FX: ≤ 6% Si, MX: 6-12% Si, CX: 12-20% Si
<b>FU, MU, CU</b>	<b>Ultrahard:</b> extremely high PCD content, very hard special binder	Excellent tool life and wear resistance	PCD tools to meet the highest demands on tool life. Laminate, MDF, clean chipboard, plastic ...
	<b>Ultrahart:</b> extrem hoher PKD-Gehalt, sehr harter Spezialbinder	Hervorragende Standwege und Abrasionsbeständigkeit	PKD-Werkzeuge, die höchsten Ansprüchen an Standwege genügen sollen. Laminat, MDF, saubere Spanplatte, Plastik ...
	<b>Ultra-dur:</b> teneur en PCD extrêmement élevée, liant spécial très dur	Durée de vie et résistance à l'abrasion excellentes	Outils PCD pour des exigences de durée de vie maximales. Laminés, MDF, panneaux de particules propres, plastique ...
	<b>Ultra resistente:</b> estrema contenuto PCD, legante molto duro specialees	Eccellente durata e resistenza all'usura	Utensili in PCD per soddisfare le richieste di longività più esigenti. Laminato, MDF, pannello truciolare pulito, plastica ...
	<b>Ultraduro:</b> contenido de PCD sumamente alto, ligante especial muy duro	Excelente vida útil y resistencia a la abrasión	Herramientas PCD capaces de hacer frente a las más altas exigencias en materia de vida útil. Laminados, aglomerados, plástico ...

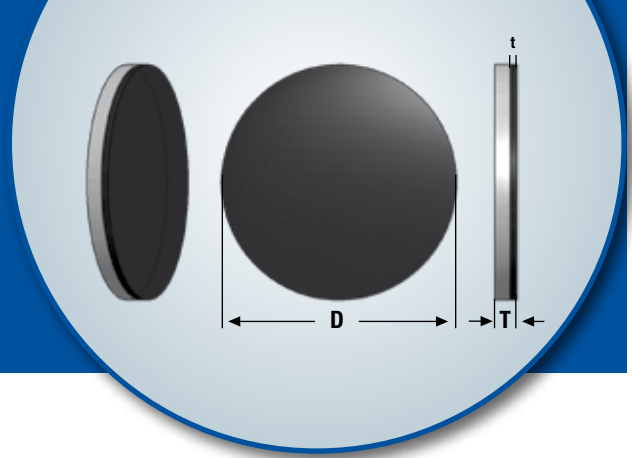







-  Standard PCD blanks
-  Standard-PKD-Ronden
-  Rondelles PCD standards
-  Dischi standard in PCD
-  Rodajas PCD estándar

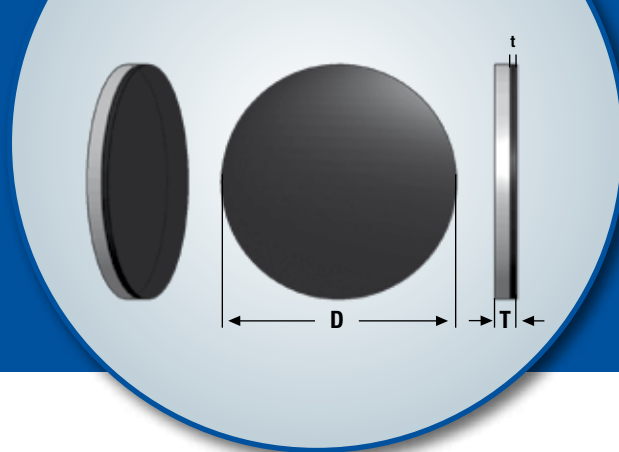





 Grade  Sorte  Nuance  Tipo  Calidad	Properties and dimensions (mm)					Article no.	
	Grain size		Binder	D mm	T mm		t mm
FS	Fine	2-4µm	Standard	50.8	1.6	0.6	360R50.8/1.6-FS
					2.0	0.6	360R50.8/2.0-FS
					3.2	0.6	360R50.8/3.2-FS
					4.8	0.6	360R50.8/4.8-FS
FX	Fine	2-4µm	Special	50.8	1.6	0.6	360R50.8/1.6-FX
					2.0	0.6	360R50.8/2.0-FX
					3.2	0.6	360R50.8/3.2-FX
					4.8	0.6	360R50.8/4.8-FX
FU	Fine	2-4µm	Ultrahard	50.8	1.6	0.6	360R50.8/1.6-FU
					2.0	0.6	360R50.8/2.0-FU
					3.2	0.6	360R50.8/3.2-FU
					4.8	0.6	360R50.8/4.8-FU
MS	Medium	8-10µm	Standard	50.8	1.6	0.6	360R50.8/1.6-MS
					2.0	0.6	360R50.8/2.0-MS
					3.2	0.6	360R50.8/3.2-MS
					4.8	0.6	360R50.8/4.8-MS
MX	Medium	8-10µm	Special	50.8	1.6	0.6	360R50.8/1.6-MX
					2.0	0.6	360R50.8/2.0-MX
					3.2	0.6	360R50.8/3.2-MX
					4.8	0.6	360R50.8/4.8-MX
MU	Medium	8-10µm	Ultrahard	50.8	1.6	0.6	360R50.8/1.6-MU
					2.0	0.6	360R50.8/2.0-MU
					3.2	0.6	360R50.8/3.2-MU
					4.8	0.6	360R50.8/4.8-MU
CS	Coarse	20-35µm	Standard	50.8	1.6	0.6	360R50.8/1.6-CS
					2.0	0.6	360R50.8/2.0-CS
					3.2	0.6	360R50.8/3.2-CS
					4.8	0.6	360R50.8/4.8-CS
CX	Coarse	20-35µm	Special	50.8	1.6	0.6	360R50.8/1.6-CX
					2.0	0.6	360R50.8/2.0-CX
					3.2	0.6	360R50.8/3.2-CX
					4.8	0.6	360R50.8/4.8-CX
CU	Coarse	20-35µm	Ultrahard	50.8	1.6	0.6	360R50.8/1.6-CU
					2.0	0.6	360R50.8/2.0-CU
					3.2	0.6	360R50.8/3.2-CU
					4.8	0.6	360R50.8/4.8-CU





-  Special PCD blanks
-  Spezial-PKD-Ronden
-  Rondelles PCD spéciales
-  Dischi speciali in PCD
-  Rodajas PCD especiales

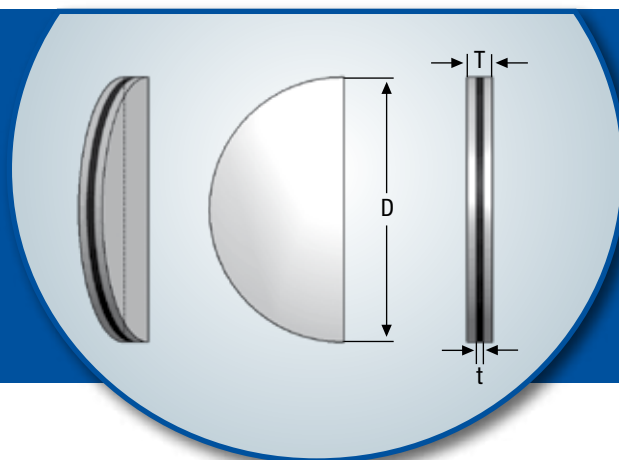

 Grade  Sorte  Nuance  Tipo  Calidad	Properties and dimensions (mm)					Article no.	
	Grain size		Binder	D	T		t
FS	Fine	2-4µm	Standard	50.8	1.0	0.3	360R50.8/t=0.3/1.0-FS
					1.2	0.3	360R50.8/t=0.3/1.2-FS
					1.6	0.3	360R50.8/t=0.3/1.6-FS
MS	Medium	8-10µm	Standard	50.8	1.0	0.3	360R50.8/t=0.3/1.0-MS
					1.2	0.3	360R50.8/t=0.3/1.2-MS
					1.6	0.3	360R50.8/t=0.3/1.6-MS
CS	Coarse	20-35µm	Standard	50.8	1.0	0.3	360R50.8/t=0.3/1.0-CS
					1.2	0.3	360R50.8/t=0.3/1.2-CS
					1.6	0.3	360R50.8/t=0.3/1.6-CS

-  Sandwich PCD - half blanks
-  Sandwich-PKD - Halbronden
-  Demies rondelles sandwich PCD
-  Mezzidischi in Sandwich PCD
-  Semirrodajas PCD en sandwich



 Sandwich grade  Sandwich-Sorte  Nuance Sandwich  Tipologia di Sandwich  Calidad Sandwich	Properties and dimensions (mm)					Article no.	
	Grain size		Binder	D	T		t
FX	Fine	2-4µm	Special	50.8	1.5	0.5	180R50.8/1.5-FX
					2.0	0.8	180R50.8/2.0-FX
					2.5	1.0	180R50.8/2.5-FX
MX	Medium	8-10µm	Special	50.8	1.5	0.5	180R50.8/1.5-MX
					2.0	0.8	180R50.8/2.0-MX
					2.5	1.0	180R50.8/2.5-MX
CX	Coarse	20-35µm	Special	50.8	1.5	0.5	180R50.8/1.5-CX
					2.0	0.8	180R50.8/2.0-CX
					2.5	1.0	180R50.8/2.5-CX

-  Cutting service
-  Schneiddienst
-  Service de coupe
-  Servizio di taglio
-  Servicio de corte

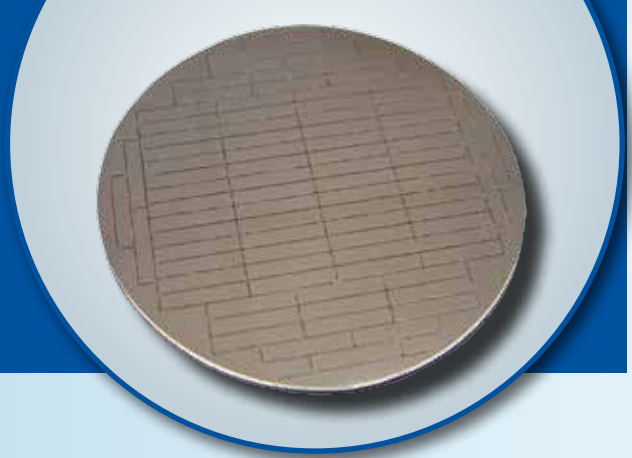

 TIGRA offers you a quick service for laser-cut PCD: according to your drawing, we cut within 3 working days, with and without angle. The segments are delivered cleaned and packaged safely. Thanks to the efficient production planning and processing, our laser-cut segments are in many cases significantly less expensive than whatever is possible by wire cutting!

 TIGRA bietet Ihnen einen Schnellservice für Laser geschnittenes PKD: nach Ihrer Zeichnung trennen wir innerhalb von 3 Arbeitstagen, mit und ohne Winkel. Die Segmente werden gereinigt und sicher verpackt ausgeliefert. Dank der effizienten Arbeitsvorbereitung und Bearbeitung sind unsere Laser geschnittenen Segmente in vielen Fällen deutlich günstiger als dies mit Drahtschneiden möglich ist!

 TIGRA vous offre un service express pour PCD découpé au laser. Nous découpons avec ou sans angle et suivant votre dessin dans un délai de 3 jours ouvrables. Les segments sont nettoyés et livrés solidement emballés. Nos segments découpés au laser sont dans de nombreux cas nettement plus avantageux que par découpe par fil grâce à la préparation du travail et à l'usinage efficaces!

 TIGRA vi offre un servizio rapido per PCD a taglio laser: in base ai vostri disegni, eseguiamo i tagli entro 3 giorni lavorativi, con e senza angoli. I segmenti vengono puliti ed imballati in modo sicuro e consegnati. Grazie all'efficienza di preparazione e lavorazione, i nostri segmenti a taglio laser sono spesso più economici di quelli ottenuti con una macchina tagliafilo!

 TIGRA ofrece un servicio rápido de corte por láser para calidades PCD: en un plazo de 3 días realizamos trabajos a medida, con o sin ángulo, conforme a su diseño. Los segmentos se entregan en embalaje seguro y limpios. Gracias a una eficiente preparación del trabajo y un óptimo mecanizado nuestros segmentos cortados por láser son en muchos casos sustancialmente más económicos que los de corte por alambre.

 Notes

 Notizen

 Notes

 Note

 Notas

Lined writing area with 25 horizontal blue lines.





**MDM**  
ТЕХНО

[mdm-techno.ru](http://mdm-techno.ru)

Москва (495) 788-44-75

Екатеринбург (343) 256-49-40/41/42/30

Ижевск (3412) 79-30-79/80-28/73-98

Иркутск (3952) 48-57-61/62

Казань (843) 512-02-35/25

Киров: (8332) 74-44-08

Краснодар (861) 210-33-24/34-06/33-75

Красноярск (391) 204-08-07/06

Нижний Новгород (831) 296-57-17/18

Новосибирск (383) 289-90-10/11/12

Пенза (8412) 22-31-47

Ростов-на-Дону (961) 311-71-37, (863) 209-83-93

Самара (846) 993-42-23/25, 993-41-96/97

Санкт-Петербург (812) 326-24-30

Уфа (347) 292-98-22/23

Хабаровск (4212) 46-70-85/95

