

Klein®

S I S T E M I

HW, HS and DP tools for wood, aluminium,
plastic working and measuring instruments

Catalog **14.A**



Klein

Klein

Klein



With an **experience of over 40 years**, **Sistemi** has become a leading manufacturer of high quality tools for working wood, aluminium and plastics.

The brand **Klein** is synonymous of high quality tools thanks to continuous investment in the use of the latest technology and in training, with a more and more young and dynamic staff, consisting of technicians, designers and trade experts fully available to meet the multiple needs that global competition requires.



















Sistemi exports its products today to more than **60 countries** around the world by consolidating its presence by the best retailers in the woodworking field and strengthening its success from year to year in order to start and develop continuously new projects, always with a view to "**customer satisfaction**".

The use of CAD together with an accurate selection of quality raw materials and a careful control performed with high precision instruments ensure the best performance of the tools, ensuring increasing productivity and a highly flexible response to any requests.

25 years of collaboration with the company m. conti have enabled us to offer also a wide range of measuring instruments for the furniture industry.

Since many years already **Sistemi** has become part of  **ACIMALL**, the Association that includes the main Italian manufacturers of machines and tools for woodworking.

Explanation of symbols

■ Lock ring	
■ O-ring	
■ Center bit	
■ Allen keys	
■ Torx keys	
■ Knives 2 cutting edges	
■ Knives 4 cutting edges	
■ Spurs	
■ Profiled knives	
■ Versofix knives	
■ Hanging packaging	
■ Hanging packaging "Hobby"	
■ Shims	
■ Ball bearings	
■ Spacers	
■ Threaded nuts	
■ Spurs	
■ Washers	
■ Spring washers	
■ Seeger	
■ Spacers	
■ Wedges	
■ Cheese head screws	
■ Countersunk head screws	
■ Allen screws	
■ Countersunk flat head screws	
■ Rounded head screws	
■ Slotted cheese head screws	
■ Screws for "Weeke" machines	

■ Softwood	
■ Hardwood	
■ Wood with small metal residues	
■ MDF	
■ Aluminium wood profiles	
■ "Sandwich" panels	
■ Single side laminated boards	
■ Double side laminated boards	
■ Single side veneer boards	
■ Double side veneer boards	
■ Plastic coated materials	
■ CORIAN®	
■ Lumber	
■ Paper coated materials	
■ Plastic materials	
■ Plexiglass	
■ Aluminium	
■ Steel and ferrous materials	
■ PVC	

Catalogue sections

The catalogue is divided into **16** sections of which the first **14** dedicated to tools, the **n. 15** to measuring instruments and the **n.16** to special equipment.

<p>1 pagg. 1.01-1.35 Router bits for hand portable machines S=Ø6 - S=Ø6,4 (1/4") - S=Ø8</p> 	<p>9 pagg. 9.01-9.28 Insert router bits and DP router bits</p> 
<p>2 pagg. 2.01-2.30 Router bits for hand portable machines S=Ø10 - S=Ø12 - S=Ø12,7 (1/2")</p> 	<p>10 pagg. 10.01-10.16 Spare Parts</p> 
<p>3 pagg. 3.01-3.16 Router bits for wood, chipboards and solid surface materials</p> 	<p>11 pagg. 11.01-11.16 Reversible knives and knives for planers</p> 
<p>4 pagg. 4.01-4.07 Router bits for handportable machines economy line</p> 	<p>12 pagg. 12.01-12.37 Sawblades</p> 
<p>5 pagg. 5.01-5.22 Dowel drills, boring bits for automatic boring machines</p> 	<p>13 pagg. 13.01-13.45 Cutterheads</p> 
<p>6 pagg. 6.01-6.16 Boring bits, slot mortising bits</p> 	<p>14 pagg. 14.01-14.10 Lubricants, diamond grinding wheels, diamond stones</p> 
<p>7 pagg. 7.01-7.31 Router bits and chucks for CNC routers</p> 	<p>15 pagg. 15.01-15.25 Measuring instruments</p> 
<p>8 pagg. 8.01-8.13 Router bits for aluminium and plastic working</p> 	<p>16 pagg. 16.01-16.21 Special devices</p> 

Materials abbreviations (as per norm EN 847-1)

SP	Alloyed tool steel
HL	High-alloy tool steel
HS	High speed steel
HW	Uncoated hardmetal on tungsten carbide base
DP	Polycrystalline diamond
VHW	Solid tungsten carbide

Technical abbreviations

mm	Millimeter	MK3	Collet chuck with morse taper shank (3)
Z	Number of teeth	Fori t.	Pin holes
Ø	Diameter	RPM	Rounds per minute
Sp.	Thickness	Nm	Newton / Meter
Rh	Right rotation	MAN	Manual feed
Lh	Left rotation	MEC	Mechanical feed
Mat.	Type of material	CNC	Computered Numerical Control
FF	Hollow end cap	DIN	German Industry Standard
FP	Extended end cap	ISO	International Organization of Standardization
MK2	Collet chuck with morse taper shank (2)		

Router bits for hand portable machines
S=Ø6 - S=Ø6,4 (1/4") - S=Ø8



1

Router bits for hand portable machines
S=Ø10 - S=Ø12 - S=Ø12,7 (1/2")



2

Router bits for wood, chipboards
and solid surface materials



3

Router bits for handportable machines
economy line



4

Dowel drills, boring bits for
automatic boring machines



5

Boring bits, slot mortising bits



6

Router bits and chucks for CNC routers



7

Router bits for aluminium
and plastic working



8

Router bits for hand portable machines

S=Ø6 - S=Ø6,4 (1/4") - S=Ø8



1



VHM STRAIGHT BITS
Page 1.07



HW STRAIGHT BITS
Page 1.07



VHM DOUBLE FLUSH
TRIMMING BITS
Page 1.08



HW PANEL PILOT BITS Z=2
Page 1.08



HW PANEL PILOT BITS Z=1+1
Page 1.08



HW DOUBLE PANEL PILOT BITS
Page 1.08

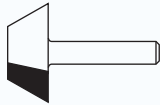

HW BEVEL TRIM BITS Z=2
Page 1.08

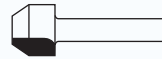

HW BEVEL TRIM BITS Z=2
Page 1.08



HW DOVETAIL BITS Z=2
Page 1.08

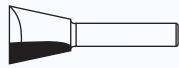

HW DOVETAIL BITS Z=2
Page 1.09

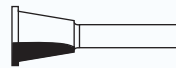

HW DOVETAIL BITS Z=2
Page 1.09

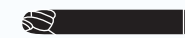

VHM U-GROOVE
AND SIGNMAKING BITS
Page 1.09



HW V-GROOVE AND SIGNMAKING BITS
Page 1.09

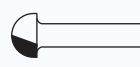

HW CORE BOX BITS Z=2
Page 1.09

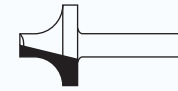

HW PLUNGING
ROUND-OVER BITS Z=2
Page 1.10

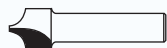

HW PLUNGING ROUND-OVER BITS Z=2
Page 1.10



HW PLUNGE TYPE OGEE BITS Z=2
Page 1.10



HW PLUNGE TYPE TRADITIONAL
BITS Z=2
Page 1.10

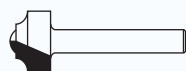

HW PLUNGE TYPE CLASSICAL
BITS Z=2
Page 1.10



HW BULL NOSE RADIUS BITS Z=2
Page 1.10

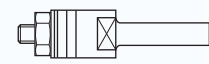

SLOT CUTTER ARBORS
Page 1.10

Klein®

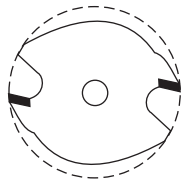

HW SLOT CUTTERS
Page 1.11

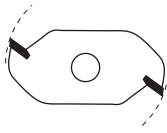

HW SLOT CUTTERS
Page 1.11

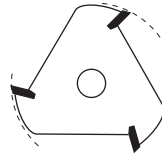

HW SLOT CUTTERS
Page 1.11

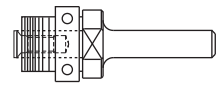

SLOT CUTTER ARBORS
Page 1.11

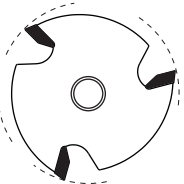

HW SLOT CUTTERS SPECIAL FIXING SCREW
Page 1.11



HW TRIMMING BITS
WITH BALL BEARING Z=2
Page 1.12



HW TRIMMING BITS
WITH BALL BEARING Z=2
Page 1.12

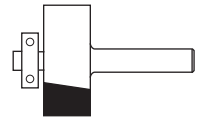

HW RABBETTING BITS
WITH BALL BEARING Z=2
Page 1.12

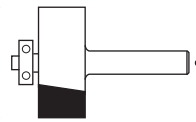

HW RABBETTING BITS WITH
BALL BEARING Z=2
Page 1.13

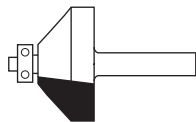

HW LEVEL TRIM BITS
WITH BALL BEARING Z=2
Page 1.13

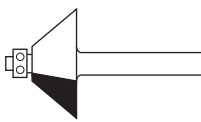

HW LEVEL TRIM BIT GUIDE
WITH BALL BEARING
Page 1.13

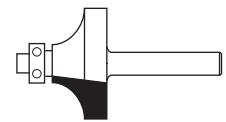

HW CORNER ROUNDING BITS
WITH BALL BEARING Z=2
Page 1.13

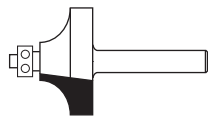

HW BEADING BITS
WITH BALL BEARING GUIDE Z=2
Page 1.13

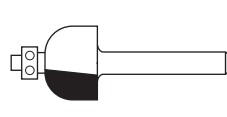

HW COVER BITS
WITH BALL BEARING GUIDE Z=2
Page 1.14

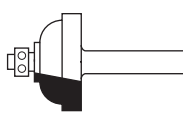

HW CLASSICAL COVER BITS
WITH BALL BEARING GUIDE Z=2
Page 1.14

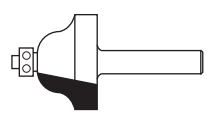

HW ROMAN OGEE BITS
WITH BALL BEARING GUIDE Z=2
Page 1.14

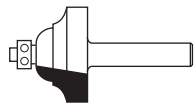

HW DOUBLE ROMAN OGEE BITS Z=2
Page 1.14



HW OGEE BITS
WITH BALL BEARING GUIDE Z=2
Page 1.14



HW OGEE BITS
WITH BALL BEARING GUIDE Z=2
Page 1.14



HW OGEE BITS
WITH BALL BEARING GUIDE Z=2
Page 1.15

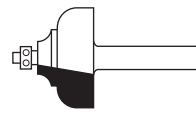

HW OGEE BITS
WITH BALL BEARING GUIDE Z=2
Page 1.15



HW OGEE BITS
WITH BALL BEARING GUIDE Z=2
Page 1.15

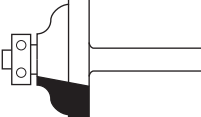

HW OGEE BITS
WITH BALL BEARING GUIDE Z=2
Page 1.15



HW CLASSICAL MOULDING BITS
WITH BALL BEARING GUIDE Z=2
Page 1.15



HW CLASSICAL MOULDING BITS
WITH BALL BEARING GUIDE Z=2
Page 1.15

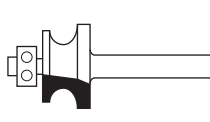

HW CORNER BEADING BITS
WITH BALL BEARING GUIDE Z=2
Page 1.16

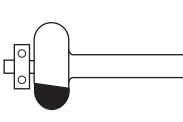

HW EDGE-FLUTING BITS
WITH BALL BEARING GUIDE Z=2
Page 1.16

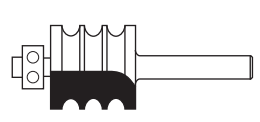

HW MULTI-BEADING BITS
WITH BALL BEARING GUIDE Z=2
Page 1.16

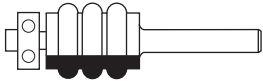

HW MULTI-BEADING BITS
WITH BALL BEARING GUIDE Z=2
Page 1.16

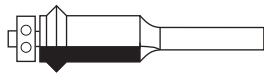

HW FLUSH-TRIM "V" GROOVE BITS
WITH BALL BEARING GUIDE Z=2
Page 1.16

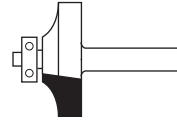

HW FLAT ROUNDING OVER BITS
WITH BALL BEARING GUIDE Z=2
Page 1.16

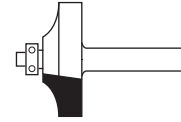

HW FLAT ROUNDING OVER BITS
WITH BALL BEARING GUIDE Z=2
Page 1.17

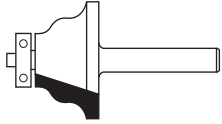

HW PROFILE BITS
WITH BALL BEARING GUIDE
Page 1.17

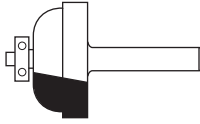

HW FLAT OGEE BITS WITH
BALL BEARING GUIDE Z=2
Page 1.17

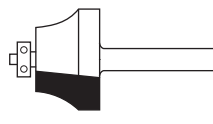

HW OVOLO JOINT BITS WITH
BALL BEARING GUIDE Z=2
Page 1.17

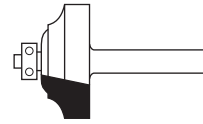

HW OGEE BITS
WITH BALL BEARING GUIDE Z=2
Page 1.17



HW PANEL PILOT BITS WITH
BALL BEARING GUIDE Z=1
Page 1.17



HW FLUSH AND BEVEL TRIM BITS Z=2
Page 1.18



HW FLUSH AND BEVEL TRIM BITS
WITH BALL BEARING GUIDE Z=2
Page 1.18

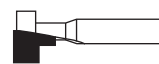

HW KEYHOLE BITS Z=1
Page 1.18

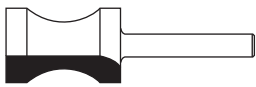

HW CONVEX EDGING BITS Z=2
Page 1.18

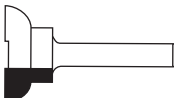

HW FINGER GRIP BITS Z=2
Page 1.18

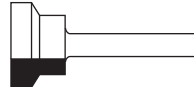

HW DRAWER LOCK BITS Z=2
Page 1.18



HW SEAL PROFILE BITS Z=2
Page 1.18

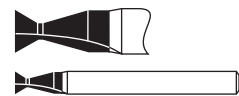

HW DOVETAIL SEAL BITS Z=2
Page 1.18



HW SEAL BITS Z=2
Page 1.19

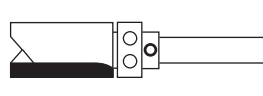

HW FLUSH TRIM BITS WITH
UPPER BALL BEARING GUIDE Z=2
Page 1.19

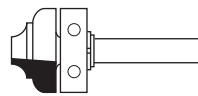

HW FLUSH TRIM BITS WITH
UPPER BALL BEARING GUIDE Z=2
Page 1.19

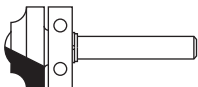

HW FLUSH TRIM BITS WITH
UPPER BALL BEARING GUIDE Z=2
Page 1.19

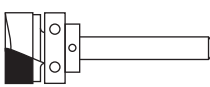

HW FLUSH TRIM BITS WITH
UPPER BALL BEARING GUIDE Z=2
Page 1.19

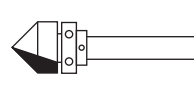

HW GROOVE BITS WITH
UPPER BALL BEARING GUIDE Z=2
Page 1.19

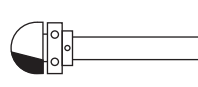

HW FLUSH TRIM BITS WITH
UPPER BALL BEARING GUIDE Z=2
Page 1.20

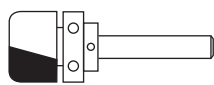

HW FLUSH TRIM BITS WITH
UPPER BALL BEARING GUIDE Z=2
Page 1.20

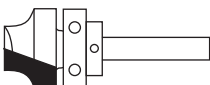

HW FLUSH TRIM BITS WITH
UPPER BALL BEARING GUIDE Z=2
Page 1.20

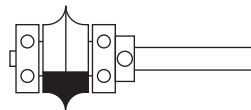

HW "LEAF-EDGE" BEADING BITS WITH
DOUBLE BALL BEARING GUIDE Z=2
Page 1.20

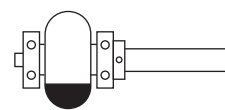

HW "EDGE-FLUTING" BITS WITH
DOUBLE BALL BEARING GUIDE Z=2
Page 1.21

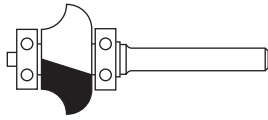

HW RADIUS BITS WITH DOUBLE BALL BEARING GUIDE Z=2
Page 1.21

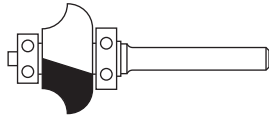

HW RADIUS BITS WITH DOUBLE BALL BEARING GUIDE Z=2
Page 1.21

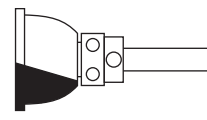

HW OVOLO RADIUS BITS WITH BALL BEARING GUIDE Z=2
Page 1.21



HW DOUBLE DIAMETER BITS Z=2
Page 1.21

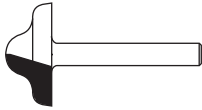

HW DOUBLE RADIUS BITS Z=2
Page 1.21

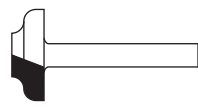

HW DOUBLE RADIUS BITS Z=2
Page 1.22

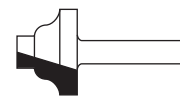

HW DOUBLE RADIUS BITS Z=2
Page 1.22

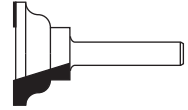

HW DOUBLE RADIUS BITS Z=2
Page 1.22



HW MULTI RADIUS BITS Z=2
Page 1.22

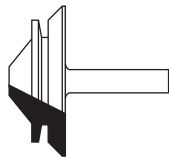

HW 45 DEGREE LOCK MITRE JOINT BITS Z=2
Page 1.22

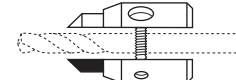

HW ADJUSTABLE COUNTERSINKS FROM 3 mm THROUGH 7 mm
Page 1.23

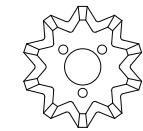

HS FLUSH TRIMMERS FOR TABLE EDGE BANDING MACHINES
Page 1.23

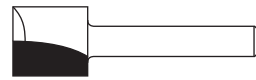

HW PLUNGE TYPE STRAIGHT BITS FOR "ELU"
Page 1.23

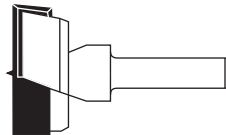

HW BORING BITS
Page 1.24

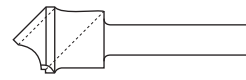

HSS COUNTERSINKS
Page 1.24



BUSHINGS
Page 1.24

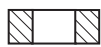

SPACERS
Page 1.24



HW INSERT FLUSH TRIMMING BITS Z=1
Page 1.25

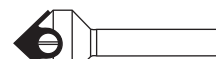

HW INSERT V-GROOVING BITS Z=1
Page 1.25



HW INSERT CORE BOX BITS WITH UPPER BALL BEARING Z=1
Page 1.25



HW INSERT FLUSH TRIMMING BITS WITH BALL BEARING
Page 1.25

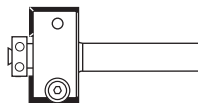

HW INSERT RABBIT BITS WITH BALL BEARING Z=2
Page 1.25



HW INSERT FLUSH TRIMMING BITS WITH BALL BEARING Z=2
Page 1.26

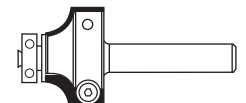

HW INSERT CORNER ROUNDING BITS WITH BALL BEARING Z=2
Page 1.26

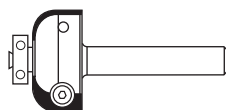

HW INSERT COVER BITS WITH BALL BEARING Z=2
Page 1.26

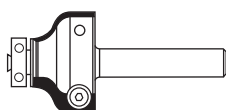

HW INSERT OGEE BITS WITH BALL BEARING Z=2
Page 1.26



6 PIECE STRAIGHT-DOVETAIL INSERT ROUTER BITS "STARTER SET"
Page 1.27



6 PIECE PROFILE INSERT ROUTER BITS "STARTER SET"
Page 1.27



6 PIECE STRAIGHT BITS
"STARTER SET"
Page 1.28



6 PIECE CORNER ROUNDING
BITS "STARTER SET"
Page 1.28



6 PIECE DOVETAIL BITS
"STARTER SET"
Page 1.29



12 PIECE CLASSICAL ROUTER BITS
"STARTER SET"
Page 1.30



12 PIECE STRAIGHT ROUTER
BITS "ADVANCED SET"
Page 1.31



12 PIECE PROFILE INSERT ROUTER
BITS "ADVANCED SET"
Page 1.32



12 PIECE DOVETAIL BITS
"ADVANCED SET"
Page 1.33



12 PIECE CORNER ROUNDING
BITS "ADVANCED SET"
Page 1.34



6 PIECE INSERT ROUTER BITS "SET"
Page 1.35



6 PIECE INSERT ROUTER BITS "SET"
Page 1.35

ROUTER BITS FOR PORTABLE ROUTERS

The high quality **Klein** router bits satisfy the most accurate applications required by the marketplace today. In order to achieve the highest level of quality, our production department has continually invested in and equipped with the advanced technologies and versatile engineering systems over the years. Moreover we always pay detail attention to the choice **Klein** of raw materials. For example, in developing our special TCT straight router bits, we collaborated with our supplier in material selection, so that these bits are produced for top market performance, precision and cutting life. Various diameters and lengths of router bits can be found in our **Klein** catalogue; in fact, there are more than a thousand different items which can meet any particular requirement in both industrial and hancraft applications.

Table for the choice of straight router bits

Items	Soft wood	Hard wood	Composite
A/B/C 101-102 VHW	XXX	XXX	XXX
A/B/C 101-102 HW brazed	XX	XXX	XXX

VHM STRAIGHT BITS

ART. A101/2/3 - B101/2/3 - C101/2/3

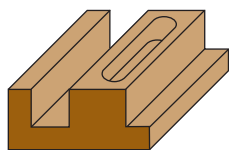
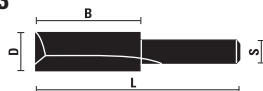

- Solid carbide
- Straight cut plunging
- To be used also for working plastic materials, acrylic, polypropylene, acetates and polycarbonates
- To be used also for C.N.C. machines



S Ø 6	S Ø 6,4 (1/4")	S Ø 8	D	B	L	Z
A101.015.R			1,5	4	46	2+1
A101.020.R	B101.020.R		2	4	46	2+1
	B101.024.R		2,4	6	46	2+1
A101.025.R			2,5	8	48	2+1
A101.030.R	B101.030.R	C101.030.R	3	11	51	2+1
	B101.032.R		3,2	11	51	2+1
A101.040.R	B101.040.R	C101.040.R	4	11	51	2+1
	B101.048.R		4,8	11	51	2+1
A101.050.R		C101.050.R	5	11	51	2+1
A101.060.R	B101.060.R	C101.060.R	6	19	51	2+1
	B101.064.R		6,4	19	51	2+1
A101.070.R	B101.070.R	C101.070.R	7	19	51	2+1
A101.080.R	B101.080.R	C101.080.R	8	19	51	2+1
	B102.048.R		4,8	16	55	2+1
A102.050.R		C102.050.R	5	16	55	2+1
A102.060.R	B102.060.R	C102.060.R	6	25	57	2+1
	B102.064.R		6,4	25	57	2+1
A102.080.R	B102.080.R	C102.080.R	8	25	57	2+1
	B103.080.R		8	32	63	2+1
A103.080.R	B103.080.R	C103.080.R	8	32	63	2+1

HW STRAIGHT BITS

ART. A101/2/3 - B101/2/3 - C101/2/3

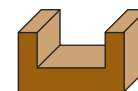
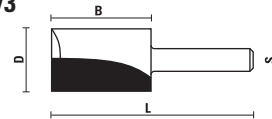

- Straight cut
- Z=2+1 also plunging



S Ø 6	S Ø 6,4 (1/4")	S Ø 8	D	B	L	Z
A101.090.R		C101.090.R	9	19	51	2
	B101.095.R		9,5	19	51	2
A101.100.R	B101.100.R	C101.100.R	10	19	51	2
A101.101.R		C101.101.R	10	19	51	2+1
A101.110.R	B101.110.R	C101.110.R	11	19	51	2
A101.120.R	B101.120.R	C101.120.R	12	19	51	2
A101.121.R		C101.121.R	12	19	51	2+1
	B101.127.R		12,7	19	51	2
A101.130.R		C101.130.R	13	19	51	2
A101.140.R	B101.140.R	C101.140.R	14	19	51	2
A101.141.R		C101.141.R	14	19	51	2+1
	B101.143.R		14,3	19	51	2
A101.150.R	B101.150.R	C101.150.R	15	19	51	2
A101.160.R	B101.160.R	C101.160.R	16	19	51	2
A101.161.R		C101.161.R	16	19	51	2+1
A101.170.R		C101.170.R NEW	17	19	51	2
	B101.175.R		17,5	19	51	2
A101.180.R	B101.180.R	C101.180.R	18	19	51	2
A101.181.R		C101.181.R	18	19	51	2+1
A101.190.R	B101.190.R	C101.190.R	19	19	51	2
A101.200.R	B101.200.R	C101.200.R	20	19	51	2
A101.201.R		C101.201.R	20	19	51	2+1
	B101.206.R		20,6	19	51	2
A101.210.R		C101.210.R	21	19	51	2
A101.220.R	B101.220.R	C101.220.R	22	19	51	2
A101.221.R		C101.221.R	22	19	51	2+1
		C101.240.R	24	19	51	2
A101.250.R		C101.250.R	25	19	51	2
	B101.254.R		25,4	19	51	2
	B102.095.R		9,5	25	57	2
A102.100.R	B102.100.R	C102.100.R	10	25	57	2
A102.101.R		C102.101.R	10	25	57	2+1
A102.120.R	B102.120.R	C102.120.R	12	25	57	2
A102.121.R		C102.121.R	12	25	57	2+1
	B102.127.R		12,7	25	57	2
		C102.140.R	14	25	57	2
A102.150.R			15	25	57	2
A102.160.R	B102.160.R	C102.160.R	16	25	57	2
A102.161.R		C102.161.R	16	25	57	2+1
	B103.095.R		9,5	32	63	2
A103.100.R	B103.100.R	C103.100.R	10	32	63	2
A103.120.R	B103.120.R	C103.120.R	12	32	63	2
	B103.127.R		12,7	32	63	2
A103.150.R			15	32	63	2
A103.160.R	B103.160.R	C103.160.R	16	32	63	2

Straight bits sets in wooden case see page 1.28 and 1.31

VHM DOUBLE FLASH TRIMMING BITS

ART. A101

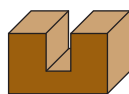

Solid carbide

S Ø 6	D	B	L	Z
A101.031.R	3	11	65	2+1

HW PANEL PILOT BITS Z=2

ART. A104 - B104 - C104

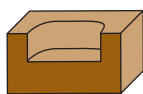
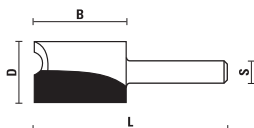

S Ø 6	S Ø 6,4 (1/4")	S Ø 8	D	B	L
A104.127.R	B104.127.R	C104.127.R	12,7	19	51
A104.160.R	B104.160.R	C104.160.R	16	19	51
A104.190.R	B104.190.R	C104.190.R	19	19	51

HW PANEL PILOT BITS Z=1+1

ART. A105 - B105 - C105

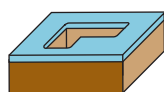
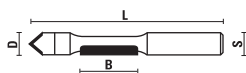

Ideal for working laminated panels

S Ø 6	S Ø 6,4 (1/4")	S Ø 8	D	B	L
A105.060.R ▲			6	19	63
A105.064.R	B105.064.R	C105.064.R	6,4	19	63
		C105.080.R	8	19	63

▲ Solid carbide

HW DOUBLE PANEL PILOT BITS

ART. A106 - C106

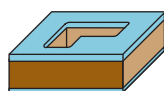
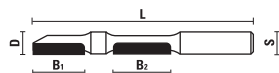

Ideal for working laminated panels top and bottom side

S Ø 6	S Ø 8	D	B1	B2	L
A106.060.R	C106.060.R	6	18	18	75

HW BEVEL TRIM BITS Z=2

ART. A107 - B107 - C107

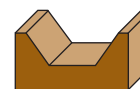
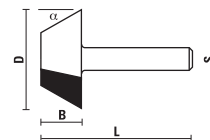

S Ø 6	S Ø 6,4 (1/4")	S Ø 8	D	α	B	L
A107.127.R	B107.127.R		12,7	15°	13	51
A107.143.R	B107.143.R		14,3	10°	16	45
A107.222.R	B107.222.R	C107.222.R	22,2	23°	10	38
A107.254.R	B107.254.R	C107.254.R	25,4	30°	10	38
A107.350.R	B107.350.R	C107.350.R	35	45°	10	38

HW BEVEL TRIM BITS Z=2

ART. A107 - B107 - C107

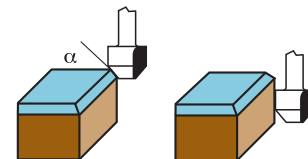
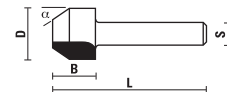

S Ø 6	S Ø 6,4 (1/4")	S Ø 8	D	α	B	L
A107.030.R	B107.030.R	C107.030.R	12,7	30°	12,7	41
A107.045.R	B107.045.R	C107.045.R	12,7	45°	12,7	41

HW DOVETAIL BITS Z=2

ART. A108

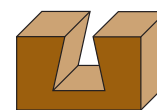

- To use for joints "Hoffman" system.
- For frames, matchboards, drawers, window and door frames, pallets and wood products in general.

S Ø 6	S Ø 8	D	α	B	L	Nr.
A108.053.R ▲		5,3	17°	4	43	1
A108.078.R ▲		7,8	18°	6	43	2
A108.093.R ▲		9,3	19°	7,5	43	3
	C108.161.R	15,8	20°	13	43	4

▲ Solid carbide

Dowel pin nr. 1



Dowel pin nr. 2

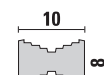

Dowel pin nr. 3

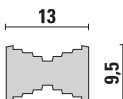

Dowel pin nr. 4

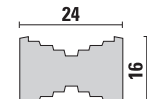

HW DOVETAIL BITS Z=2

ART. A108

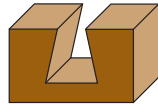
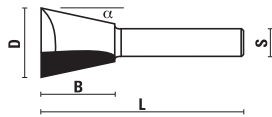

S Ø 6	S Ø 6,4 (1/4")	D	α	B	L
A108.064.R ▲	B108.064.R	6,4	7°	8	63
A108.080.R ▲	B108.080.R	8	9°	9,5	63
A108.095.R	B108.095.R	9,5	9°	9,5	42
A108.127.R	B108.127.R	12,7	14°	13	45
A108.150.R		15	12°	14,5	58
A108.160.R	B108.160.R	16	13°	16	45
A108.190.R	B108.190.R	19	14°	19	65

▲ Solid carbide

S Ø 8	D	α	B	L
C108.064.R	6,4	7°	8	44
C108.080.R	8	9°	9,5	42
C108.095.R	9,5	9°	9,5	47
C108.127.R	12,7	14°	13	49
C108.150.R	15	12°	14,5	61
C108.160.R	16	13°	16	49
C108.190.R	19	14°	19	55
C108.191.R NEW	19	7°	19	60

Dovetail bits sets in wooden case see page 1.29 and 1.33

HW DOVETAIL BITS Z=2

ART. A108

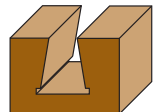
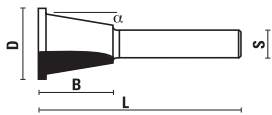

S Ø 6	S Ø 6,4 (1/4")	S Ø 8	D	α	B	L
A108.143.R	B108.143.R	C108.143.R	14,3	13°	13,5	55

VHM U-GROOVE AND SIGMAKING BITS

ART. A111

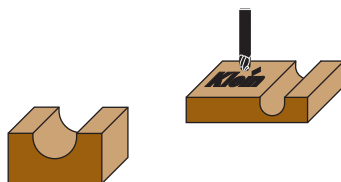

- Solid carbide
- Suitable for engravings and sign writing

S Ø 6	D	R	B	L	Z
A111.060.R NEW	6	3	9	60	3

HW V-GROOVE AND SIGMAKING BITS

ART. A109 - B109 - C109
A110 - B110 - C110

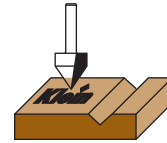
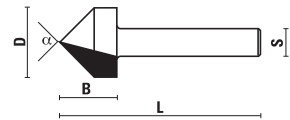

- Suitable for engravings and sign writing

S Ø 6	S Ø 6,4 (1/4")	S Ø 8	D	α	B	L	Z
A109.060.R ▲		C109.060.R	6	90°	8	45	2
A109.095.R	B109.095.R	C109.095.R	9,5	90°	11	45	2
A109.127.R	B109.127.R	C109.127.R	12,7	90°	13	45	2
A109.160.R	B109.160.R	C109.160.R	16	90°	13	45	2
A109.190.R	B109.190.R	C109.190.R	19	90°	16	45	2
A109.254.R	B109.254.R	C109.254.R	25,4	90°	19	48	2
		① C109.380.R	38	90°	20	63	2

A110.127.R	B110.127.R	C110.127.R	12,7	60°	16	45	2
A110.140.R	B110.140.R	C110.140.R	14	60°	22	57	3
		② C110.190.R	19	45°	25	63	2

▲ Solid carbide

① - ② Items for working plasterboard panels

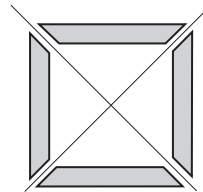

① Bit makes a 45° chamfer that can be used to build square share

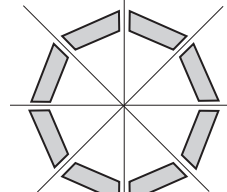

② Bit makes a 22,5° chamfer that can be used to build a B-side box (to an octagonal)

HW CORE BOX BITS Z=2

ART. A111 - B111 - C111

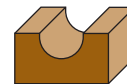
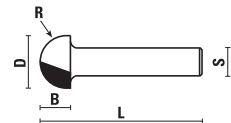

S Ø 6	S Ø 6,4 (1/4")	S Ø 8	D	R	B	L
A111.032.R ▲	B111.032.R	C111.032.R	3,2	1,6	10	44
A111.048.R ▲	B111.048.R	C111.048.R	4,8	2,4	13	44
A111.064.R ▲	B111.064.R	C111.064.R	6,4	3,2	13	44
A111.080.R ▲	B111.080.R	C111.080.R	8	4	13	47
A111.095.R	B111.095.R	C111.095.R	9,5	4,8	7	38
A111.127.R	B111.127.R	C111.127.R	12,7	6,4	10	38
A111.160.R	B111.160.R	C111.160.R	16	8	11	40
A111.180.R	B111.180.R	C111.180.R	18	9	19	47
A111.220.R	B111.220.R	C111.220.R	22	11	14	45
A111.254.R	B111.254.R	C111.254.R	25,4	12,7	17	47

▲ Solid carbide

HW PLUNGING ROUND-OVER BITS Z=2

ART. A112 - B112 - C112

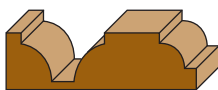
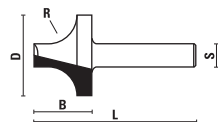

S Ø 6	S Ø 6,4 (1/4")	S Ø 8	D	R	B	L
A112.140.R		C112.140.R	14	4	13	41
A112.160.R		C112.160.R	16	5	13	41
A112.180.R		C112.180.R	18	6	13	41
A112.190.R	B112.190.R	C112.190.R	19	6,4	13	41
A112.220.R	B112.220.R	C112.220.R	22	8	14,5	43
A112.254.R	B112.254.R	C112.254.R	25,4	9,5	16	44
		C112.350.R	35	12,7	25,4	63

HW PLUNGING ROUND-OVER BITS Z=2

ART. C112

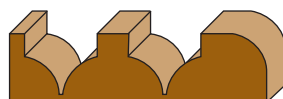

S Ø 8	D	R	B	L
C112.030.R	8	3	10	50
C112.040.R	10	4	10	50
C112.050.R	12	5	10	50

HW PLUNGE TYPE OGEE BITS Z=2

ART. A113 - B113 - C113

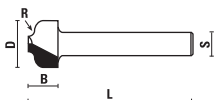

S Ø 6	S Ø 6,4 (1/4")	S Ø 8	D	R	B	L
A113.095.R	B113.095.R	C113.095.R	9,5	1,6	8	51
A113.127.R	B113.127.R	C113.127.R	12,7	2	10	51
A113.190.R	B113.190.R	C113.190.R	19	3,5	13	54

HW PLUNGE TYPE TRADITIONAL BITS Z=2

ART. A114 - B114 - C114

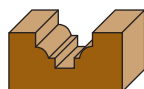
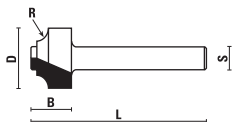

S Ø 6	S Ø 6,4 (1/4")	S Ø 8	D	R	B	L
A114.127.R	B114.127.R	C114.127.R	12,7	2	10	51
A114.190.R	B114.190.R	C114.190.R	19	3,5	11	52

HW PLUNGE TYPE CLASSICAL BITS Z=2

ART. A115 - B115 - C115

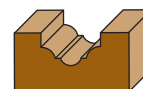
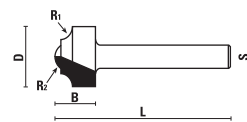

S Ø 6	S Ø 6,4 (1/4")	S Ø 8	D	R1	R2	B	L
A115.127.R	B115.127.R	C115.127.R	12,7	2,5	3,5	10	51
A115.190.R	B115.190.R	C115.190.R	19	3,7	4	13	54
		C115.254.R	25,4	5	6,4	17,5	73

HW BULL NOSE RADIUS BITS Z=2

ART. A116 - B116 - C116

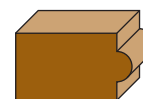
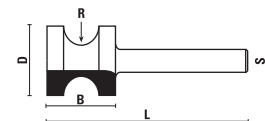

S Ø 6	S Ø 6,4 (1/4")	S Ø 8	D	R	B	L
A116.135.R	B116.135.R	C116.135.R	13,5	2	13	41
A116.150.R	B116.150.R	C116.150.R	15	2,8	13	42
A116.167.R	B116.167.R	C116.167.R	16,7	3,6	19	48
A116.222.R	B116.222.R	C116.222.R	22,2	5,2	19	48
A116.260.R	B116.260.R	C116.260.R	26	6,8	25	54

SLOT CUTTER ARBORS

ART. A117 - B117 - C117 - E117 - G117

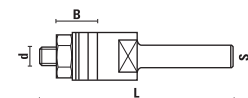

S Ø 6	S Ø 6,4 (1/4")	S Ø 8	d	B	L
A117.060.R	B117.060.R		6	17	52
A117.080.R	B117.080.R		7,94	34	67
		C117.060.R	6	17	57
		C117.079.R	7,94	34	70
		C117.080.N	7,94	53	96
		C117.081.N	7,94	66	108
		C117.082.N	7,94	38	80

S Ø 12	S Ø 12,7 (1/2")	d	B	L
E117.120.N	G117.120.R	7,94	53	96
E117.121.N	G117.121.R	7,94	66	108
E117.122.N	G117.122.R	7,94	38	80
E117.123.N	G117.123.R	7,94	34	76

Used with cutters Art. A118 - C118, spacers Art. Z057 and ball bearing Art. Z050.006.N (see section 10)

HW SLOT CUTTERS

ART. A118

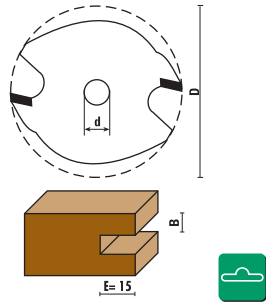

Bore Ø 6	d	D	B	Z
A118.015.R	6	40	1,5	2
A118.018.R	6	40	1,8	2
A118.020.R	6	40	2	2
A118.025.R	6	40	2,5	2
A118.030.R	6	40	3	2
A118.035.R	6	40	3,5	2
A118.040.R	6	40	4	2
A118.050.R	6	40	5	2
A118.060.R	6	40	6	2

HW SLOT CUTTERS

ART. C118

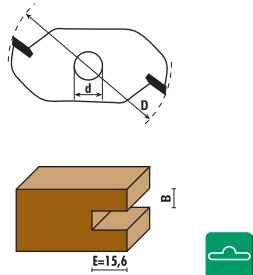

Bore Ø 8	d	D	B	Z
C118.216.R	7,94	47,6	1,6	2
C118.220.R	7,94	47,6	2	2
C118.224.R	7,94	47,6	2,4	2
C118.230.R	7,94	47,6	3	2
C118.232.R	7,94	47,6	3,2	2
C118.240.R	7,94	47,6	4	2
C118.248.R	7,94	47,6	4,8	2
C118.250.R	7,94	47,6	5	2
C118.260.R	7,94	47,6	6	2
C118.264.R	7,94	47,6	6,4	2

HW SLOT CUTTERS

ART. C118

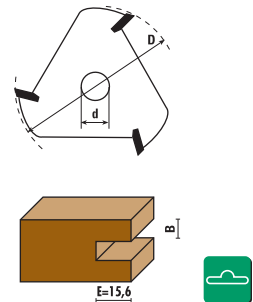

Bore Ø 8	d	D	B	Z
C118.316.R	7,94	47,6	1,6	3
C118.320.R	7,94	47,6	2	3
C118.324.R	7,94	47,6	2,4	3
C118.330.R	7,94	47,6	3	3
C118.332.R	7,94	47,6	3,2	3
C118.340.R	7,94	47,6	4	3
C118.348.R	7,94	47,6	4,8	3
C118.350.R	7,94	47,6	5	3
C118.360.R	7,94	47,6	6	3
C118.364.R	7,94	47,6	6,4	3

SLOT CUTTER ARBORS

ART. A117 - B117 - C117 - E117 - G117

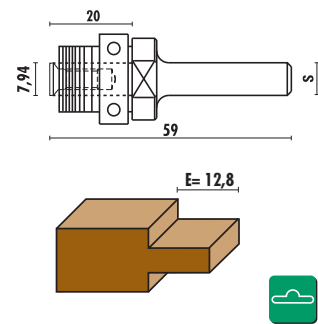

S Ø 6 S Ø 6,4 (1/4") S Ø 8 S Ø 12 S Ø 12,7 (1/2")
 A117.280.R B117.280.R C117.280.R E117.280.R G117.280.R
 With ball bearing



Z050.008.N



Z051.015.R



nr. 2 - Z054.002.N - 1 mm
 nr. 2 - Z054.003.N - 0,5 mm
 nr. 5 - Z054.004.N - 0,1 mm
 nr. 2 - Z054.005.N - 3 mm

Change the ball bearing to get different cutting depths (see page...)

A117.281.R B117.281.R C117.281.R E117.281.R G117.281.R
 Without ball bearing



Z051.015.R



nr. 3 - Z054.002.N - 1 mm
 nr. 2 - Z054.003.N - 0,5 mm
 nr. 6 - Z054.004.N - 0,1 mm
 nr. 2 - Z054.005.N - 3 mm
 nr. 1 - Z054.006.N - 6 mm

HW SLOT CUTTERS SPECIAL FIXING SCREW

ART. C118

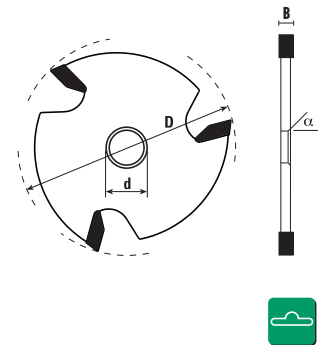

$\alpha = 45^\circ$ bore

Bore Ø 8	d	D	B	Z
C118.830.R NEW	7,94	47,6	3	3
C118.832.R NEW	7,94	47,6	3,2	3
C118.840.R NEW	7,94	47,6	4	3
C118.848.R NEW	7,94	47,6	4,8	3
C118.850.R NEW	7,94	47,6	5	3
C118.860.R NEW	7,94	47,6	6	3
C118.864.R NEW	7,94	47,6	6,4	3

The fixing screw (Art. Z051.015.R) used on this spindle has a special head angle that allows it to remain flat on the cutter level.

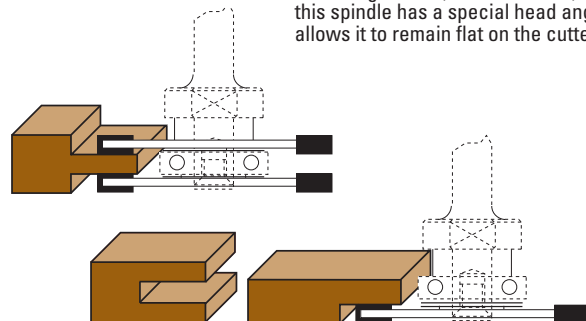

HW TRIMMING BITS WITH BALL BEARING Z=2

ART. A119 - B119 - C119

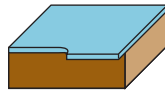
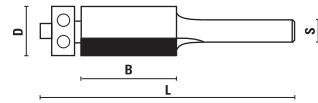

Ideal for working laminated panels

S Ø 6	S Ø 6,4 (1/4")	D	B	L
A119.064.R	B119.064.R	6,4	13	53



S Ø 6	S Ø 6,4 (1/4")	S Ø 8	D	B	L
A119.095.R	B119.095.R	C119.095.R	9,5	13	54



S Ø 6	S Ø 6,4 (1/4")	S Ø 8	D	B	L
A119.127.R	B119.127.R	C119.127.R	12,7	13	60



HW TRIMMING BITS WITH BALL BEARING Z=2

ART. A119 - B119 - C119

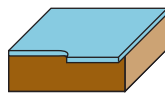
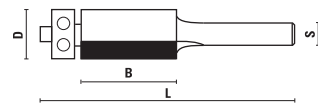

- Ideal for working laminated panels
- Shear angle cutting edge

S Ø 6	S Ø 6,4 (1/4")	S Ø 8	D	B	L
A119.160.R	B119.160.R	C119.160.R	16	16	56



S Ø 6	S Ø 6,4 (1/4")	S Ø 8	D	B	L
A119.190.R	B119.190.R	C119.190.R	19	16	60



S Ø 6	S Ø 6,4 (1/4")	S Ø 8	D	B	L
A119.191.R	B119.191.R	C119.191.R	19	25	72

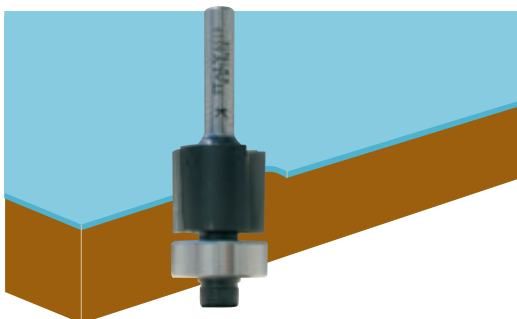

HW TRIMMING BITS WITH BALL BEARING Z=2

ART. A120 - B120 - C120

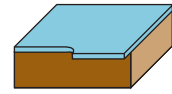
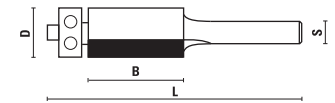

Ideal for working laminated panels

S Ø 6	S Ø 6,4 (1/4")	D	B	L
A120.064.R	B120.064.R	6,4	25	67



S Ø 6	S Ø 6,4 (1/4")	S Ø 8	D	B	L
A120.095.R	B120.095.R	C120.095.R	9,5	25	67



S Ø 6	S Ø 6,4 (1/4")	S Ø 8	D	B	L
A120.127.R	B120.127.R	C120.127.R	12,7	25	67



HW RABBETING BITS WITH BALL BEARING Z=2

ART. A121 - B121 - C121

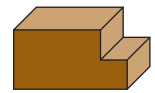
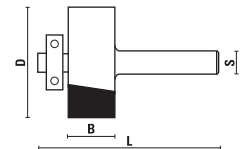

S Ø 6	S Ø 6,4 (1/4")	S Ø 8	D	B	E	L
A121.240.R	B121.240.R	C121.240.R	24	13	4	54



S Ø 6	S Ø 6,4 (1/4")	S Ø 8	D	B	E	L
A121.317.R	B121.317.R	C121.317.R	31,7	13	9,5	51



S Ø 6	S Ø 6,4 (1/4")	S Ø 8	D	B	E	L
A121.350.R	B121.350.R	C121.350.R	35	13	11	51



HW RABBETING BITS WITH BALL BEARING Z=2

ART. A121 - B121 - C121

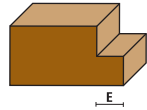
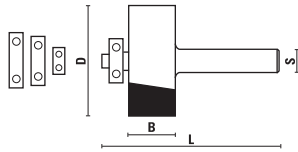

Supplied with nr. 4 ball bearings in order to obtain E= 8 - 9,5 - 11 - 12,7

S Ø 6	S Ø 6,4 (1/4")	S Ø 8	D	R	E	L
A121.850.R	B121.850.R	C121.850.R	35	13	8/9,5/11/12,7	51



HW LEVEL TRIM BITS WITH BALL BEARING Z=2

ART. A122

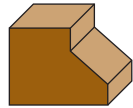
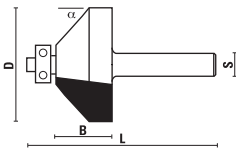

S Ø 6	S Ø 8	D	α	B	L
A122.350.R	B122.350.R	35	45°	18	57



HW LEVEL TRIM BITS WITH BALL BEARING GUIDE

ART. A122 - B122 - C122

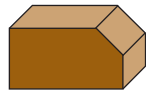
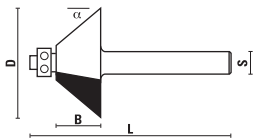

S Ø 6	S Ø 6,4 (1/4")	S Ø 8	D	α	B	L	Z
A122.010.R	B122.010.R		17,5	10°	10	49	3
A122.015.R	B122.015.R	C122.015.R	19	15°	10	49	3
A122.025.R	B122.025.R	C122.025.R	22	25°	10	49	3
A122.045.R	B122.045.R	C122.045.R	30	45°	10	49	3



S Ø 6	S Ø 6,4 (1/4")	S Ø 8	D	α	B	L	Z
A122.130.R	B122.130.R		13	15°	12,7	46	2
A122.190.R	B122.190.R		19	25°	12,7	46	2
A122.317.R	B122.317.R	C122.317.R	31,7	45°	13	51	2



HW CORNER ROUNDING BITS WITH BALL BEARING Z=2

ART. A123 - B123 - C123

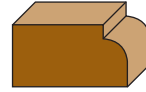
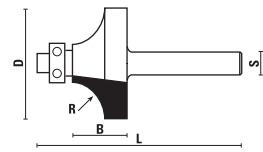

S Ø 6	S Ø 6,4 (1/4")	S Ø 8	D	R	B	L
A123.160.R	B123.160.R	C123.160.R	16	1,6	8	46
A123.167.R		C123.167.R	16,7	2	8	47
A123.187.R		C123.187.R	18,7	3	9,5	49
A123.190.R	B123.190.R	C123.190.R	19	3,2	10	48
A123.207.R	B123.207.R	C123.207.R	20,7	4	10	49
A123.222.R	B123.222.R	C123.222.R	22,2	4,8	13	51
A123.227.R		C123.227.R	22,7	5	12	51
A123.247.R		C123.247.R	24,7	6	12	51
A123.254.R	B123.254.R	C123.254.R	25,4	6,4	13	51
A123.286.R	B123.286.R	C123.286.R	28,6	8	13	51
A123.318.R	B123.318.R	C123.318.R	31,8	9,5	16	56
A123.327.R		C123.327.R	32,7	10	16	55
A123.354.R	B123.354.R	C123.354.R	35,4	11	17	57
A123.367.R		C123.367.R	36,7	12	20	57
A123.380.R	B123.380.R	C123.380.R	38	12,7	19	57



Corner rounding bits sets in wooden case see page 1.34

HW BEADING BITS WITH BALL BEARING GUIDE Z=2

ART. A124 - B124 - C124

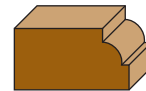
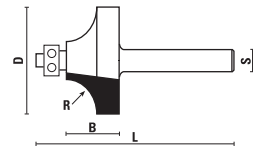

S Ø 6	S Ø 6,4 (1/4")	S Ø 8	D	R	B	L
A124.160.R	B124.160.R	C124.160.R	16	1,6	8	46
A124.167.R		C124.167.R	16,7	2	8	47
A124.187.R		C124.187.R	18,7	3	9,5	49
A124.190.R	B124.190.R	C124.190.R	19	3,2	10	48
A124.207.R	B124.207.R	C124.207.R	20,7	4	10	49
A124.222.R	B124.222.R	C124.222.R	22,2	4,8	13	51
A124.227.R		C124.227.R	22,7	5	12	51
A124.247.R		C124.247.R	24,7	6	12	51
A124.254.R	B124.254.R	C124.254.R	25,4	6,4	13	51
A124.286.R	B124.286.R	C124.286.R	28,6	8	13	51
A124.318.R	B124.318.R	C124.318.R	31,8	9,5	16	56
A124.327.R		C124.327.R	32,7	10	16	55
A124.367.R		C124.367.R	36,7	12	20	57
A124.380.R	B124.380.R	C124.380.R	38	12,7	19	57



HW COVER BITS WITH BALL BEARING GUIDE Z=2

ART. A125 - B125 - C125

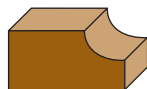
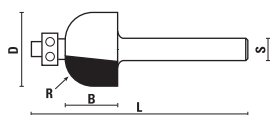

S Ø 6	S Ø 6,4 (1/4")	S Ø 8	D	R	B	L
A125.160.R	B125.160.R	C125.160.R	16	3,2	13	51
A125.190.R	B125.190.R	C125.190.R	19	4,8	14	51
A125.222.R	B125.222.R	C125.222.R	22,2	6,4	14	51
A125.254.R	B125.254.R	C125.254.R	25,4	8	14	51
A125.286.R	B125.286.R	C125.286.R	28,6	9,5	14	51
A125.350.R	B125.350.R	C125.350.R	35	12,7	16	54



Z050.001.N



Z053.001.N



Z054.001.N



Z051.001.R

HW CLASSICAL COVER BITS WITH BALL BEARING GUIDE Z=2

ART. A126 - B126 - C126

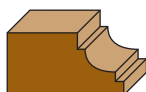
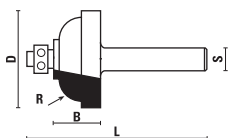

S Ø 6	S Ø 6,4 (1/4")	S Ø 8	D	R	B	L
A126.286.R	B126.286.R	C126.286.R	28,6	4,8	13	51
A126.350.R	B126.350.R	C126.350.R	35	8	16	54



Z050.003.N



Z053.003.N



Z054.002.N



Z051.002.R

HW ROMAN OGEE BITS WITH BALL BEARING GUIDE Z=2

ART. A127 - B127 - C127

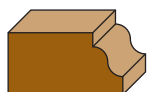
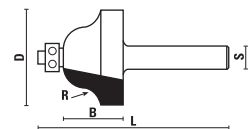

S Ø 6	S Ø 6,4 (1/4")	S Ø 8	D	R	B	L
A127.254.R	B127.254.R	C127.254.R	25,4	4	16	54
A127.350.R	B127.350.R	C127.350.R	35	6,4	20	57



Z050.001.N



Z053.001.N



Z054.001.N



Z051.001.R

HW DOUBLE ROMAN OGEE BITS Z=2

ART. A128 - B128 - C128

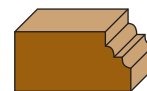
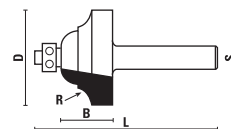

S Ø 6	S Ø 6,4 (1/4")	S Ø 8	D	R	B	L
A128.254.R	B128.254.R	C128.254.R	25,4	4	16	53
A128.350.R	B128.350.R	C128.350.R	35	6,4	20	57



Z050.001.N



Z053.001.N



Z054.001.N



Z051.001.R

HW OGEE BITS WITH BALL BEARING GUIDE Z=2

ART. A129 - B129 - C129

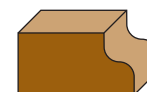
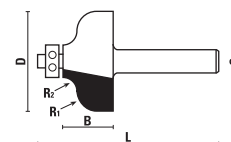

S Ø 6	S Ø 6,4 (1/4")	S Ø 8	D	R1	R2	B	L
A129.286.R	B129.286.R	C129.286.R	28,6	4,5	4	13	51
A129.350.R	B129.350.R	C129.350.R	35	6	5	18	55



Z050.003.N



Z053.003.N



Z054.002.N



Z051.002.R

HW OGEE BITS WITH BALL BEARING GUIDE Z=2

ART. A130 - B130 - C130

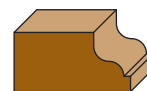
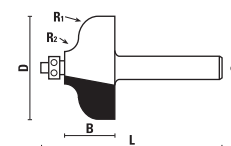

S Ø 6	S Ø 6,4 (1/4")	S Ø 8	D	R1	R2	B	L
A130.286.R	B130.286.R	C130.286.R	28,6	4,5	4	13	51
A130.350.R	B130.350.R	C130.350.R	35	6	5	18	55



Z050.002.N



Z053.002.N



Z054.002.N



Z051.002.R

HW OGEE BITS WITH BALL BEARING GUIDE Z=2

ART. A131 - B131 - C131

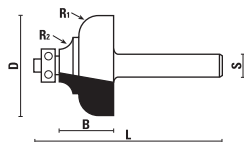

S Ø 6	S Ø 6,4 (1/4")	S Ø 8	D	R1	R2	B	L
A131.286.R	B131.286.R	C131.286.R	28,6	4	4	13	51
A131.350.R	B131.350.R	C131.350.R	35	6,4	4,8	18	56



Z050.003.N



Z053.003.N



Z054.002.N



Z051.002.R

HW OGEE BITS WITH BALL BEARING GUIDE Z=2

ART. A132 - B132 - C132

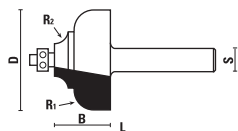

S Ø 6	S Ø 6,4 (1/4")	S Ø 8	D	R1	R2	B	L
A132.286.R	B132.286.R	C132.286.R	28,6	4	4	13	51
A132.350.R	B132.350.R	C132.350.R	35	6,4	4,8	18	56



Z050.002.N



Z053.002.N



Z054.002.N



Z051.002.R

HW OGEE BITS WITH BALL BEARING GUIDE Z=2

ART. A133 - B133 - C133

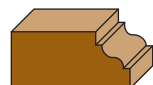
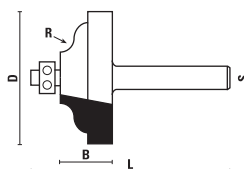

S Ø 6	S Ø 6,4 (1/4")	S Ø 8	D	R	B	L
A133.350.R	B133.350.R	C133.350.R	35	4	14	52



Z050.002.N



Z053.002.N



Z054.002.N



Z051.002.R

HW OGEE BITS WITH BALL BEARING GUIDE Z=2

ART. A134 - B134 - C134

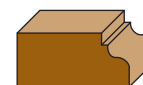
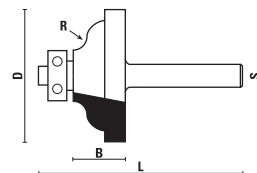

S Ø 6	S Ø 6,4 (1/4")	S Ø 8	D	R	B	L
A134.350.R	B134.350.R	C134.350.R	35	4	14	52



Z050.003.N



Z053.003.N



Z054.002.N



Z051.002.R

HW CLASSICAL MOULDING BITS WITH BALL BEARING GUIDE Z=2

ART. A135 - B135 - C135

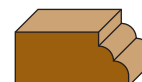
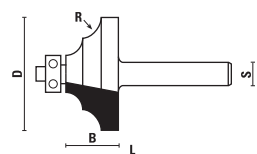

S Ø 6	S Ø 6,4 (1/4")	S Ø 8	D	R	B	L
A135.286.R	B135.286.R	C135.286.R	28,6	4	13	51
A135.350.R	B135.350.R	C135.350.R	35	5,5	18	60



Z050.003.N



Z053.003.N



Z054.002.N



Z051.002.R

HW CLASSICAL MOULDING BITS WITH BALL BEARING GUIDE Z=2

ART. A136 - B136 - C136

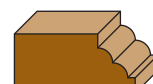
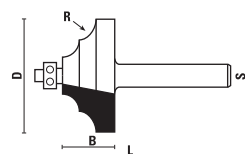

S Ø 6	S Ø 6,4 (1/4")	S Ø 8	D	R	B	L
A136.286.R	B136.286.R	C136.286.R	28,6	4	13	51
A136.350.R	B136.350.R	C136.350.R	35	5,5	18	60



Z050.002.N



Z053.002.N



Z054.002.N



Z051.002.R

HW CORNER BEADING BITS WITH BALL BEARING GUIDE Z=2

ART. A137 - B137 - C137

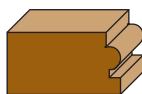
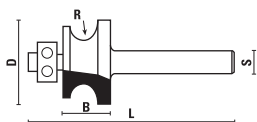

S Ø 6	S Ø 6,4 (1/4")	S Ø 8	D	R	B	L
A137.220.R	B137.220.R	C137.220.R	22	3,2	14	54



Z050.003.N



Z053.003.N



Z054.002.N



Z051.002.R

S Ø 6	S Ø 6,4 (1/4")	S Ø 8	D	R	B	L
A137.280.R	B137.280.R	C137.280.R	28	4,8	16	57
A137.320.R	B137.320.R	C137.320.R	32	6,4	19	58



Z050.004.N



Z053.004.N



Z054.002.N



Z051.002.R

HW EDGE-FLUTING BITS WITH BALL BEARING GUIDE Z=2

ART. A138 - B138

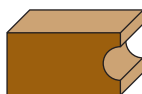
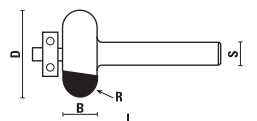

S Ø 6	S Ø 6,4 (1/4")	D	R	B	L
A138.210.R	B138.210.R	21	4	8	47
A138.230.R	B138.230.R	23	5	10	49
A138.250.R	B138.250.R	25	6	12	51



Z050.003.N



Z053.003.N



Z054.002.N



Z051.002.R

HW MULTI-BEADING BITS WITH BALL BEARING GUIDE Z=2

ART. A139 - B139

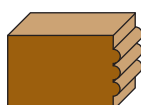
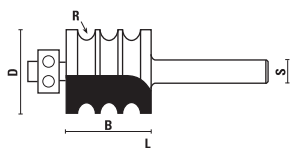

S Ø 6	S Ø 6,4 (1/4")	D	R	B	L
A139.220.R	B139.220.R	22	3	25	65



Z050.004.N



Z053.004.N



Z054.002.N



Z051.002.R

HW MULTI-BEADING BITS WITH BALL BEARING GUIDE Z=2

ART. A140 - B140

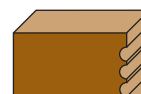
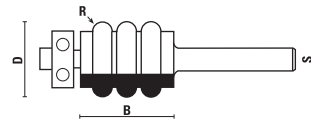

S Ø 6	S Ø 6,4 (1/4")	D	R	B	L
A140.220.R	B140.220.R	22	3	25	64



Z050.004.N



Z053.004.N



Z054.002.N



Z051.002.R

HW FLUSH-TRIM "V" GROOVE BITS WITH BALL BEARING GUIDE Z=2

ART. A141 - B141

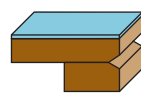
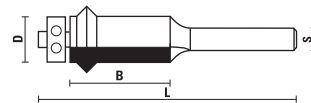

- Ideal for working laminated and melamine panels
- V-decor along the joints of the two wood pieces

S Ø 6	S Ø 6,4 (1/4")	D	B	L
A141.127.R	B141.127.R	12,7	25,4	67



Z050.003.N



Z053.003.N



Z054.002.N



Z051.002.R

HW FLAT ROUNDING OVER BITS WITH BALL BEARING GUIDE Z=2

ART. A142 - B142 - C142

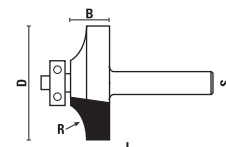

S Ø 6	S Ø 6,4 (1/4")	S Ø 8	D	R	B	L
A142.300.R	B142.300.R	C142.300.R	30	12	10	48



Z050.003.N



Z053.003.N



Z054.002.N



Z051.002.R

HW FLAT ROUNDING OVER BITS WITH BALL BEARING GUIDE Z=2

ART. A143 - B143 - C143

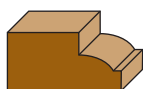
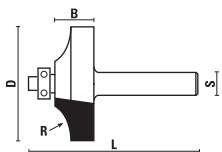

S Ø 6	S Ø 6,4 (1/4")	S Ø 8	D	R	B	L
A143.300.R	B143.300.R	C143.300.R	30	12	10	48



Z050.002.N



Z053.002.N



Z054.002.N



Z051.002.R

HW PROFILE BITS WITH BALL BEARING GUIDE

ART. A144 - B144 - C144

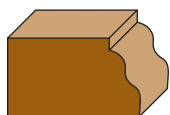
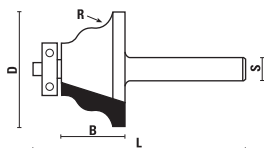

S Ø 6	S Ø 6,4 (1/4")	D	R	B	L
A144.318.R	B144.318.R	31,8	4	17,5	57



Z050.003.N



Z053.003.N



Z054.002.N



Z051.002.R

HW FLAT OGEE BITS WITH BALL BEARING GUIDE Z=2

ART. A145 - B145 - C145

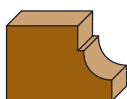
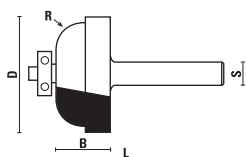

S Ø 6	S Ø 6,4 (1/4")	S Ø 8	D	R	B	L
A145.286.R	B145.286.R	C145.286.R	28,6	4,8	13	51
A145.350.R	B145.350.R	C145.350.R	35	8	16	55



Z050.003.N



Z053.003.N



Z054.002.N



Z051.002.R

HW OVOLO JOINT BITS WITH BALL BEARING GUIDE Z=2

ART. A146 - B146 - C146

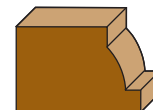
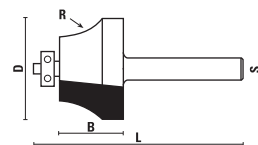

This tool can be used in combination with Art. A175 - B175 - C175

S Ø 6	S Ø 8	D	R	B	L
A146.270.R	C146.270.R selling out	27	17	17	57
A146.335.R	C146.335.R selling out	33,5	9	15	57



Z050.002.N



Z053.002.N



Z054.002.N



Z051.002.R

HW OGEE BITS WITH BALL BEARING GUIDE Z=2

ART. A147 - B147 - C147

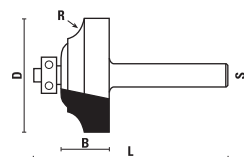

S Ø 6	S Ø 6,4 (1/4")	S Ø 8	D	R	B	L
A147.318.R	B147.318.R	C147.318.R	31,8	5	13	51
A147.380.R	B147.380.R	C147.380.R	38	6	16	54



Z050.003.N



Z053.003.N



Z054.002.N



Z051.002.R

HW PANEL PILOT BITS WITH BALL BEARING GUIDE Z=1

ART. A150 - C150

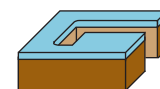
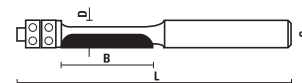

Ideal for working laminated panels

S Ø 6	S Ø 8	D	B	L
A150.064.R	C150.064.R	6,4	19	57



Z050.017.N

HW FLUSH AND BEVEL TRIM BITS Z=2

ART. A151 - C151

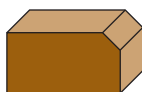
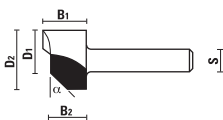

S Ø 6	S Ø 8	D1	D2	B1	B2	α
A151.200.R	C151.200.R	20	24	15	11	0°/45°

HW FLUSH AND BEVEL TRIM BITS WITH BALL BEARING GUIDE Z=2

ART. A152 - C152

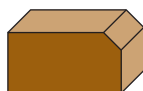
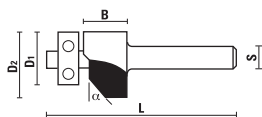

S Ø 6	S Ø 8	D1	D2	B1	B2	α
A152.190.R	C152.190.R	19	26	15	49	0°/45°



Z050.006.N

HW KEYHOLE BITS Z=1

ART. A153

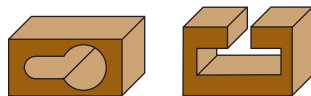
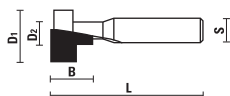

S Ø 6	S Ø 6,4 (1/4")	S Ø 8	D1	D2	B	L
A153.098.R	B153.098.R	C153.098.R	9,8	5	9,8	38,1
A153.127.R	B153.127.R	C153.127.R	12,7	8	9,8	38,1

HW CONVEX EDGING BITS Z=2

ART. A154

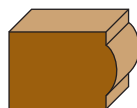
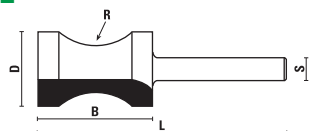

S Ø 6	S Ø 6,4 (1/4")	S Ø 8	D	R	B	L
A154.202.R	B154.202.R	C154.202.R	20,2	18	32	62,6

HW FINGER GRIP BITS Z=2

ART. A155 - B155

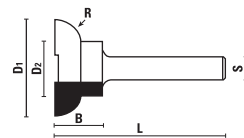

S Ø 6	S Ø 6,4 (1/4")	D1	D2	R	B	L
A155.280.R	B155.280.R	28	15	6,4	13	41

HW DRAWER LOCK BITS Z=2

ART. A156 - B156

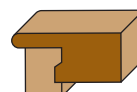
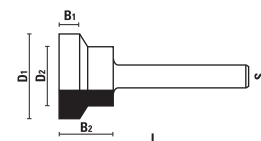

S Ø 6	S Ø 6,4 (1/4")	D1	D2	B1	B2	L
A156.254.R	B156.254.R	25,4	18,5	4	13	49

HW SEAL PROFILE BITS Z=2

ART. A157

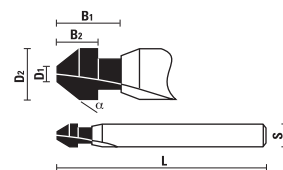

S Ø 6	S Ø 6,4 (1/4")	D2	D1	α	B1	B2	L
A157.055.R	B157.055.R	5,5	2	38°	8	4	65

HW DOVETAIL SEAL BITS Z=2

ART. A158

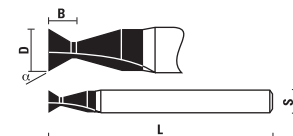

S Ø 6	S Ø 6,4 (1/4")	D	α	B	L
A158.051.R	B158.051.R	5,1	25°	4	60

HW SEAL BITS Z=2

ART. A159 - B159

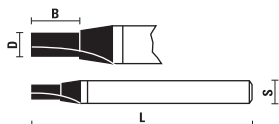

S Ø 6	S Ø 6,4 (1/4")	D	B	L
A159.030.R	B159.030.R	3	8	55

HW FLUSH TRIM BITS WITH UPPER BALL BEARING GUIDE Z=2

ART. A160 - B160

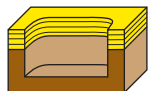
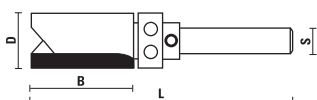

S Ø 6	S Ø 6,4 (1/4")	D	B	L
A160.127.R	B160.127.R	12,7	25,4	63
A160.128.R	B160.128.R	12,7	32	69



Z050.007.N



Z058.001.N



Z052.005.N



Z051.005.R

S Ø 6	S Ø 6,4 (1/4")	D	B	L
A160.160.R	B160.160.R	16	25,4	63



Z050.011.N



Z058.001.N



Z052.005.N



Z051.005.R

S Ø 6	S Ø 6,4 (1/4")	D	B	L
A160.190.R	B160.190.R	19	25,4	63



Z050.005.N



Z058.001.N



Z052.005.N



Z051.005.R

HW FLUSH TRIM BITS WITH UPPER BALL BEARING GUIDE Z=2

ART. A161 - B161

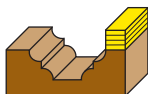
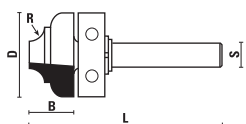

S Ø 6	S Ø 6,4 (1/4")	D	R	B	L
A161.220.R	B161.220.R	22	3,5	11	51



Z050.008.N



DIN 471-15

HW FLUSH TRIM BITS WITH UPPER BALL BEARING GUIDE Z=2

ART. A162 - B162

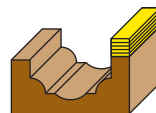
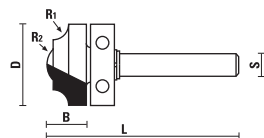

S Ø 6	S Ø 6,4 (1/4")	D	R1	R2	B	L
A162.220.R	B162.220.R	22	4	5,5	12	51



Z050.008.N



DIN 471-15

HW FLUSH TRIM BITS WITH UPPER BALL BEARING GUIDE Z=2

ART. A163 - B163

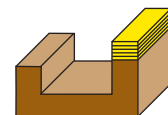
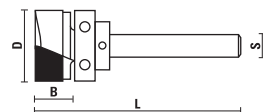

If shank Ø8 mm is needed, use sleeves Art. Z010 see page 10.03

S Ø 6	S Ø 6,4 (1/4")	D	B	L
A163.190.R	B163.190.R	19	11	56



Z050.005.N



Z058.001.N



Z051.005.R

HW GROOVE BITS WITH UPPER BALL BEARING GUIDE Z=2

ART. A164 - B164

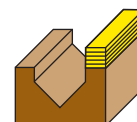
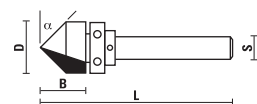

S Ø 6	S Ø 6,4 (1/4")	D	α	B	L
A164.127.R	B164.127.R	12,7	45°	13	51



Z050.007.N



Z058.001.N



Z052.005.N



Z051.005.R

HW FLUSH TRIM BITS WITH UPPER BALL BEARING GUIDE Z=2

ART. A165 - C165

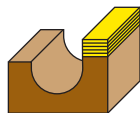
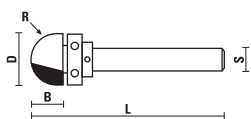

S Ø 6	S Ø 6,4 (1/4")	D	R	B	L
A165.127.R	B165.127.R	12,7	6,4	9,5	51



Z050.007.N



Z058.001.N



Z051.005.R

HW FLUSH TRIM BITS WITH UPPER BALL BEARING GUIDE Z=2

ART. A166 - C166

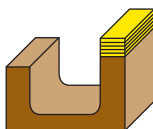
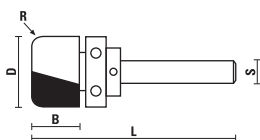

S Ø 6	S Ø 6,4 (1/4")	D	R	B	L
A166.127.R	B166.127.R	12,7	3,2	13	54



Z050.007.N



Z058.001.N



Z051.005.R

S Ø 6	S Ø 6,4 (1/4")	D	R	B	L
A166.190.R	B166.190.R	19	6,4	16	59



Z050.005.N



Z058.001.N



Z051.005.R

HW FLUSH TRIM BITS WITH UPPER BALL BEARING GUIDE Z=2

ART. A167 - C167

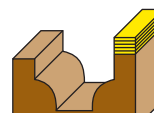
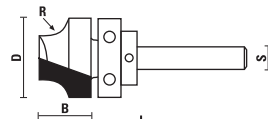

S Ø 6	S Ø 6,4 (1/4")	D	R	B	L
A167.127.R	B167.127.R	12,7	3	9,5	48



Z050.007.N



Z058.001.N



Z051.005.R

S Ø 6	S Ø 6,4 (1/4")	D	R	B	L
A167.220.R	B167.220.R	22	5	12	55



Z050.008.N



Z058.001.N



Z051.005.R

S Ø 6	S Ø 6,4 (1/4")	D	R	B	L
A167.286.R	B167.286.R	28,6	8	15	58



Z050.015.N



Z058.003.N



Z051.005.R

HW "LEAF-EDGE" BEADING BITS WITH DOUBLE BALL BEARING GUIDE Z=2

ART. A168 - B168

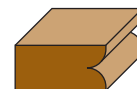
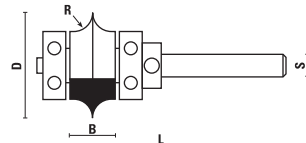

S Ø 6	S Ø 6,4 (1/4")	D	R	B	L
A168.254.R	B168.254.R	25,4	4,8	13	66
A168.286.R	B168.286.R	28,6	6,4	16	69



Z050.011.N



Z058.001.N



Z053.002.N



Z051.004.R



Z051.005.R

HW "EDGE-FLUTING" BITS WITH DOUBLE BALL BEARING GUIDE Z=2

ART. A169 - B169

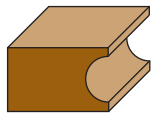
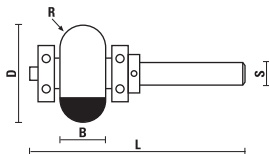

S Ø 6	S Ø 6,4 (1/4")	D	R	B	L
A169.190.R	B169.190.R	19	3,2	6,4	57
A169.230.R	B169.230.R	23	5	10	61



Z050.007.N
upper



Z058.001.N



Z051.005.R



Z050.003.N
lower



Z053.003.N



Z054.002.R



Z051.002.R

HW RADIUS BITS WITH DOUBLE BALL BEARING GUIDE Z=2

ART. A170 - B170 - C170

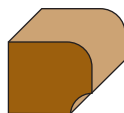
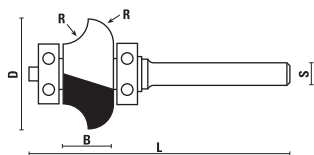

Patent

S Ø 6	S Ø 8	D	R	B	L
A170.285.R*	C170.285.R*	28,5	6,4	14	66
A170.320.R*	C170.320.R*	32	8	17	69
A170.350.R*	C170.350.R*	35	9,5	20	72

* selling out



Z050.018.N



Z058.001.N



Z051.005.R

HW RADIUS BITS WITH DOUBLE BALL BEARING GUIDE Z=2

ART. A171 - B171 - C171

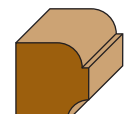
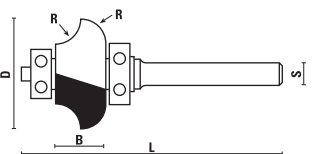

Patent

S Ø 6	S Ø 8	D	R	B	L
A171.285.R*	C171.285.R*	28,5	6,4	14	66
A171.320.R*	C171.320.R*	32	8	17	69
A171.350.R*	C171.350.R*	35	9,5	20	72

* selling out



Z050.019.N



Z058.001.N



Z051.005.R

HW OVOLO RADIUS BITS WITH BALL BEARING GUIDE Z=2

ART. A175 - B175

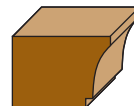
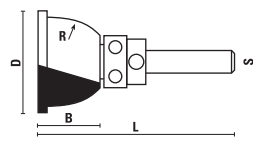

This tool can be used in combination with Art. A146 - B146 - C146

S Ø 6	D	R	B	L
A175.300.R selling out	30	17	16	52
A175.360.R selling out	36	9	12	52



Z050.007.N



Z058.001.N



Z051.005.R

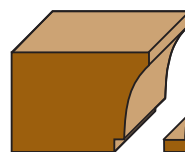

art. A175

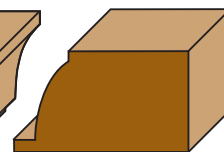

art. A146

HW DOUBLE DIAMETER BITS Z=2

ART. A180 - B180

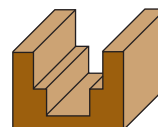
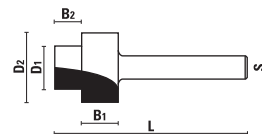

S Ø 6	S Ø 6,4 (1/4")	D1	D2	B1	B2	L
A180.095.R	B180.095.R	9,5	19	12,7	6,4	48
A180.127.R	B180.127.R	12,7	19	9,5	6,4	51

HW DOUBLE RADIUS BITS Z=2

ART. A181 - B181 - C181

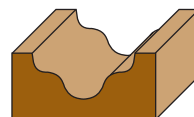
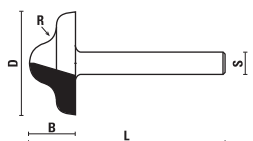

S Ø 6	S Ø 6,4 (1/4")	S Ø 8	D	R	B	L
A181.270.R	B181.270.R	C181.270.R	27	6	12	52

HW DOUBLE RADIUS BITS Z=2

ART. A182 - B182 - C182

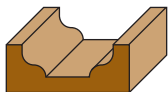
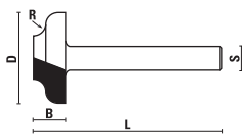

S Ø 6	S Ø 6,4 (1/4")	S Ø 8	D	R	B	L
A182.254.R	B182.254.R	C182.254.R	25,4	3,2	9,5	50

HW MULTI RADIUS BITS Z=2

ART. A191 - C191

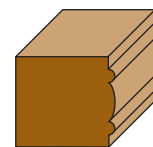
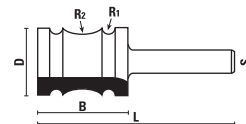

S Ø 6	S Ø 6,4 (1/4")	D	R1	R2	B	L
A191.190.R	B191.190.R	19	2	6	25	55

HW DOUBLE RADIUS BITS Z=2

ART. A185 - B185

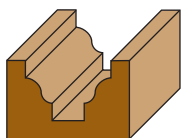
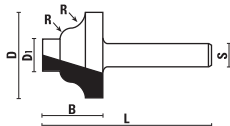

S Ø 6	S Ø 6,4 (1/4")	D	D1	R	B	L
A185.210.R	B185.210.R	21	8	3,2	13	42
A185.250.R	B185.250.R	25	8	4	17	45

HW 45 DEGREE LOCK MITRE JOINT BITS Z=2

ART. A195 - C195

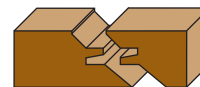
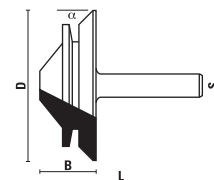

S Ø 6	S Ø 6,4 (1/4")	D	α	B	L
A195.380.R	B195.380.R	38	45°	13	41
A195.420.R	B195.420.R	42	45°	16	45

HW DOUBLE RADIUS BITS Z=2

ART. A186 - B186

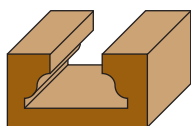
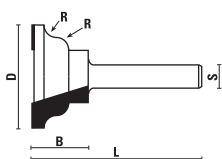

S Ø 6	S Ø 6,4 (1/4")	D	D1	R	B	L
A186.250.R	B186.250.R	25	12	3,2	13	42
A186.290.R	B186.290.R	29	12	4	17	45

HW ADJUSTABLE COUNTERSINKS FROM 3 mm THROUGH 7 mm

ART. A199

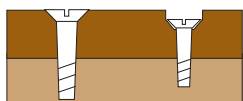
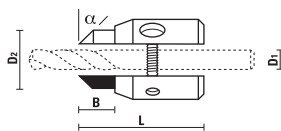

- Spare key supplied; single packed
- On request display free of charge by min order 10 pcs.



Item	D1	D2	α	B	L
A199.030.R	3/7	11/15	45°	12	32

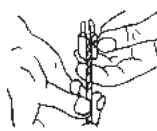

Insert the tool



Adjust the boring depth

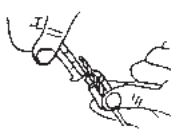

Line up the cutting edges of countersink and tool



Tighten the screws

HS FLUSH TRIMMERS FOR TABLE EDGE BANDING MACHINES

ART. AG

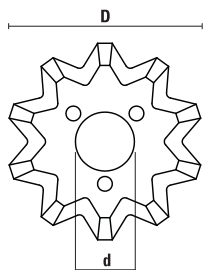

To be used on "VITAP" machines



Item	D	d	B	Z
AG040.01012 NEW	40	12	1,1	10

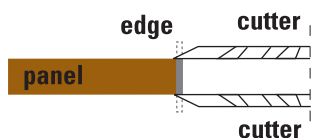

HW PLUNGE TYPE STRAIGHT BITS FOR "ELU"

ART. C190

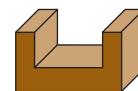
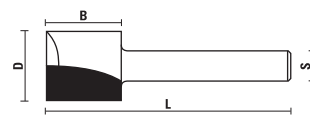

Straight cut plunging

S Ø 8	D	B	L	Z
C190.030.R ▲	3	10	55	2+1
C190.040.R ▲	4	12	55	2+1
C190.050.R ▲	5	14	55	2+1
C190.060.R ▲	6	16	55	2+1
C190.070.R ▲	7	18	55	2+1
C190.080.R ▲	8	20	55	2+1
C190.081.R ▲ NEW	8	40	90	2+1
C190.090.R ▲	9	20	55	2+1
C190.100.R ▲	10	20	55	2+1
C190.101.R NEW	10	30	70	2+1
C190.102.R NEW	10	40	90	2+1
C190.120.R	12	20	60	2+1
C190.121.R	12	20	100	2+1
C190.122.R NEW	12	30	70	2+1
C190.123.R NEW	12	40	90	2+1
C190.140.R	14	20	60	2+1
C190.141.R	14	20	100	2+1
C190.142.R NEW	14	40	90	2+1
C190.150.R	15	20	70	2+1
C190.160.R	16	20	70	2+1
C190.161.R	16	20	100	2+1
C190.162.R	16	40	90	2+1
C190.163.R NEW	16	30	70	2+1
C190.180.R	18	20	70	2+1
C190.181.R NEW	18	30	70	2+1
C190.182.R NEW	18	40	90	2+1
C190.200.R	20	20	70	2+1
C190.201.R	20	20	100	2+1
C190.202.R NEW	20	30	70	2+1
C190.203.R NEW	20	40	90	2+1
C190.220.R	22	16	70	2+1
C190.221.R	22	20	100	2+1
C190.222.R NEW	22	30	70	2+1
C190.223.R NEW	22	40	90	2+1
C190.240.R	24	16	70	2+1
C190.241.R NEW	24	30	70	2+1
C190.250.R	25	16	70	2+1

▲ Solid Carbide

HW BORING BITS

ART. C192

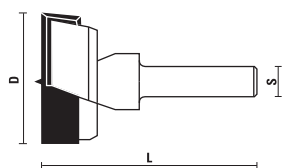

Without spurs



RH Rotation	D	L	S
C192.250.R	25	57	8
C192.260.R	26	57	8
C192.300.R	30	57	8
C192.350.R	35	57	8

HS COUNTERSINKS

ART. C240

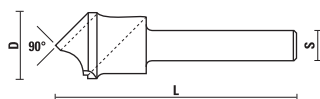

S Ø 8x30	D	L
C240.160.R	16	55

BUSHINGS

ART. Z001

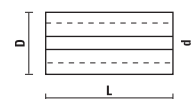

Item	D	d	L
Z001.001.N	8	6	25
Z001.002.N	9,5	6	25
Z001.003.N	9,5	8	25
Z001.004.N	10	8	25
Z001.005.N	12	8	25
Z001.006.N	12	6	25
Z001.009.N	8	6,4	25
Z001.011.N	10	6	25
Z001.017.N	9,5	6,4	25
Z001.019.N	12,7	8	25
Z001.020.N	12,7	6,4	25

SPACERS

ART. Z057

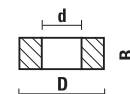

Item	D	d	B
Z057.001.N	16	7,94	3,6
Z057.002.N	16	7,94	1
Z057.003.N	16	7,94	0,5
Z057.004.N	16	7,94	0,1
Z057.005.N	16	7,94	3
Z057.006.N	16	7,94	6
Z057.007.N	16	7,94	0,4
Z057.008.N	16	7,94	0,05
Z057.009.N	16	7,94	5,3
Z057.010.N	9,5	6,4	2,2
Z057.101.N	10	6	1
Z057.102.N	10	6	1,5
Z057.103.N	10	6	3

INSERT ROUTER BITS FOR PORTABLE ROUTERS

Always looking for innovative products and most useful solutions, **SISTEMI** has developed a new line of **Klein** router bits with interchangeable carbide knives, which have a higher hardness than the tips used in traditional brazed router bits. The main advantages granted by the use of HM reversible knives and the possibility of their easy replacement are:

- **Longer tool life** ⇒ the knives are getting less worn out and in case of damage they can be easily replaced;
- **Better finish quality** ⇒ also working abrasive materials, the cutting edge can be maintained always sharp;
- **Higher measures precision** ⇒ the dimensions of the tools are not changing because there is no resharping;
- **Better Quality/Price ratio** ⇒ higher production efficiency, less costs and better performances;

HW INSERT FLUSH TRIMMING BITS Z=1

ART. WC101

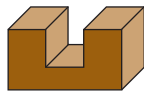
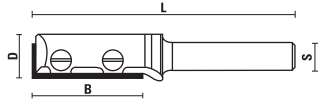

Complete with reversible knives



S Ø 8	D	B	L
WC101.120.R	12	29,5	66
Z055.330.N	Z051.501.R		

HW INSERT V-GROOVING BITS Z=1

ART. WC109

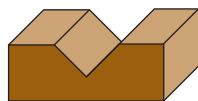
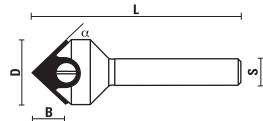

Complete with reversible knives



S Ø 8	D	B	α	L
WC109.176.R	17,6	8,5	45°	53
Z055.001.N	Z051.501.R			

HW INSERT CORE BOX BITS WITH UPPER BALL BEARING Z=1

ART. WC111

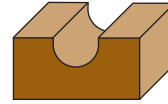
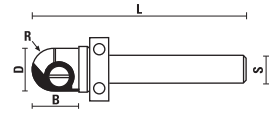

Complete with reversible knives



S Ø 8	D	R	B	L
WC111.127.R	12,7	13	6	59
Z050.018.N	Z055.550.N	Z051.501.R		

HW INSERT FLUSH TRIMMING BITS WITH BALL BEARING

ART. WC120

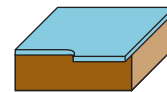
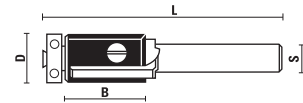

Complete with reversible knives



S Ø 8	D	R	B	L
WC120.127.R	12,7	20	62	2
Z050.003.N	Z055.551.N	Z051.503.N Screw for ball bearing	Z051.501.R Screw for knives	

HW INSERT RABBIT BITS WITH BALL BEARING Z=2

ART. WC121

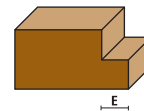
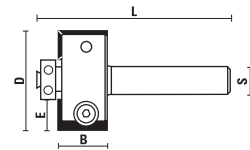

Complete with reversible knives



S Ø 8	D	B	E	L
WC121.286.R	28,6	13,2	7,95	48
Z050.002.N	Z055.552.N	Z051.503.N Screw for ball bearing	Z051.501.R Screw for knives	

HW INSERT FLUSH TRIMMING BITS WITH BALL BEARING Z=2

ART. WC122

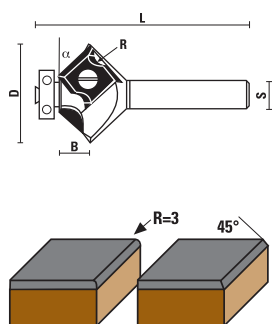

- Complete with reversible knives
- The same knives can be used for both 45° and R= 3 bevel



S Ø 8	D	B	R	α	L
WC122.273.R	27,3	5,7	3	45°	59



Z050.003.N



Z055.553.N



Z051.503.N

Screw for ball bearing



Z051.501.R

Screw for knives

HW INSERT COVER BITS WITH BALL BEARING Z=2

ART. WC125

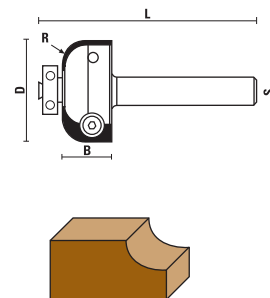

Complete with reversible knives



S Ø 8	D	B	R	L
WC125.260.R	26	12,7	6	55



Z050.003.N



Z055.555.N



Z051.503.N

Screw for ball bearing



Z051.501.R

Screw for knives

HW INSERT CORNER ROUNDING BITS WITH BALL BEARING Z=2

ART. WC123

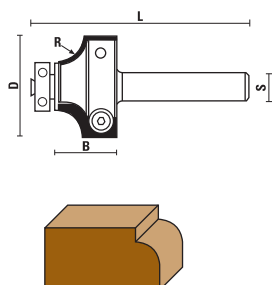

Complete with reversible knives



S Ø 8	D	B	R	L
WC123.260.R	26	15,7	6	55



Z050.003.N



Z055.554.N



Z051.503.N

Screw for ball bearing



Z051.501.R

Screw for knives

HW INSERT OGEE BITS WITH BALL BEARING Z=2

ART. WC129

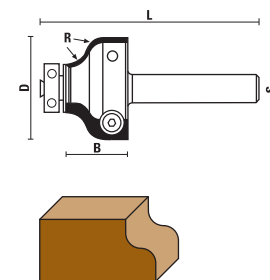

Complete with reversible knives



S Ø 8	D	B	R	L
WC129.260.R	26	15,7	4,5	55



Z050.003.N



Z055.556.N



Z051.503.N

Screw for ball bearing



Z051.501.R

Screw for knives

6 PIECE STRAIGHT-DOVETAIL INSERT ROUTER BITS "STARTER SET"

ART. X001



- Set including the 6 most popular T.C.T. router bits in a robust and practical wooden box.
- Ideal to have always on hand the right bit for straight cuts, trimming and engraving.

Item		
X001.006.R (S Ø 6)	X001.064.R (Ø 6,4 (1/4"))	X001.008.R (S Ø 8)
6-pcs router bit set:	6-pcs router bit set:	6-pcs router bit set:
A101.060.R	B101.064.R	C101.060.R
A101.160.R	B101.160.R	C101.160.R
A105.064.R	B105.064.R	C105.064.R
A108.127.R	B108.127.R	C108.127.R
A109.127.R	B109.127.R	C109.127.R
A119.127.R	B119.127.R	C119.127.R

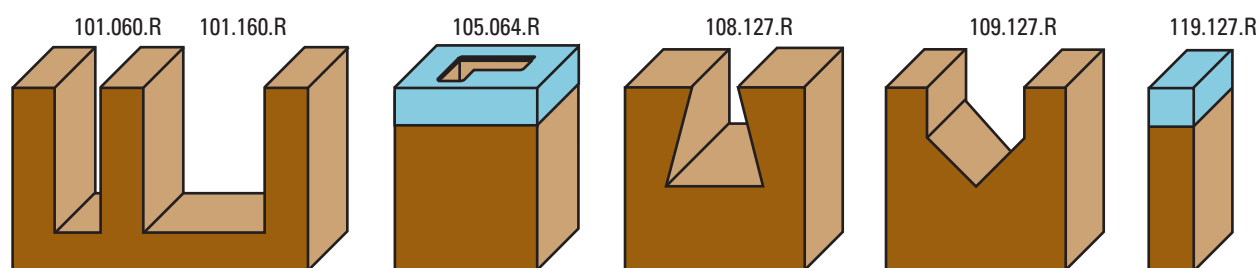

Scale 1:1

6 PIECE PROFILE INSERT ROUTER BITS "STARTER SET"

ART. X002



- Set including the 6 most popular T.C.T. router bits in a robust and practical wooden box.
- Ideal to have always on hand the right bit for straight cuts, trimming and profiling.

Item		
X002.006.R (S Ø 6)	X002.064.R (Ø 6,4 (1/4"))	X002.008.R (S Ø 8)
6-pcs router bit set:	6-pcs router bit set:	6-pcs router bit set:
A101.060.R	B101.064.R	C101.060.R
A119.127.R	B119.127.R	C119.127.R
A122.317.R	B122.317.R	C122.317.R
A123.254.R	B123.254.R	C123.254.R
A125.254.R	B125.254.R	C125.254.R
A127.254.R	B127.254.R	C127.254.R

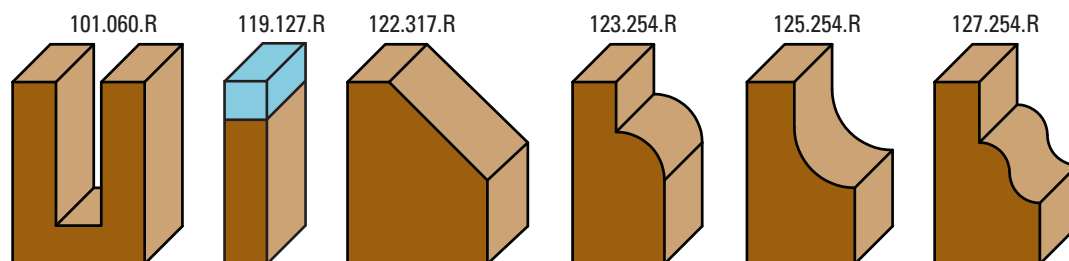

Scale 1:1

6 PIECE STRAIGHT BITS "STARTER SET"

ART. X003



- Set including the 6 most popular T.C.T. router bits in a robust and practical wooden box.
- Ideal to have always on hand the right bit for straight cuts.

Item

X003.006.R (S Ø 6) **NEW**

X003.064.R (Ø 6,4 (1/4")) **NEW**

X003.008.R (S Ø 8) **NEW**

6-pcs router bit set:

6-pcs router bit set:

6-pcs router bit set:

A101.030.R

B101.030.R

C101.030.R

A101.040.R

B101.040.R

C101.040.R

A101.060.R

B101.060.R

C101.060.R

A101.080.R

B101.080.R

C101.080.R

A103.100.R

B103.100.R

C103.100.R

A103.120.R

B103.120.R

C103.120.R

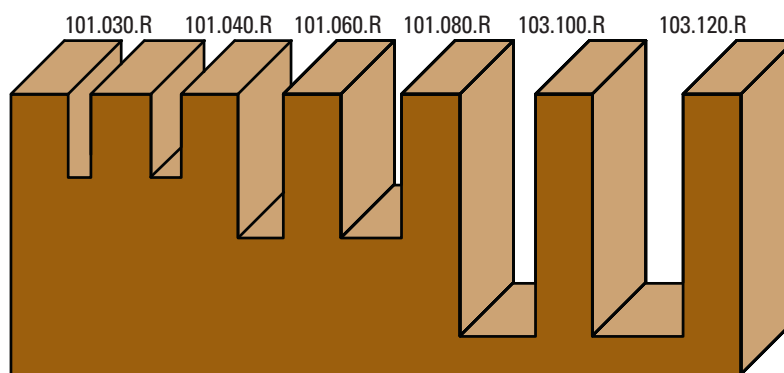

Scale 1:1

6 PIECE CORNER ROUNDING BITS "STARTER SET"

ART. X011



- Set including the 6 most popular T.C.T. router bits in a robust and practical wooden box.
- Ideal to have always on hand the right bit to produce corner roundings.

Item

X011.006.R (S Ø 6) **NEW**

X011.064.R (Ø 6,4 (1/4")) **NEW**

X011.008.R (S Ø 8) **NEW**

6-pcs router bit set:

6-pcs router bit set:

6-pcs router bit set:

A123.167.R

B123.167.R

C123.167.R

A123.187.R

B123.187.R

C123.187.R

A123.207.R

B123.207.R

C123.207.R

A123.227.R

B123.227.R

C123.227.R

A123.247.R

B123.247.R

C123.247.R

A123.286.R

B123.286.R

C123.286.R

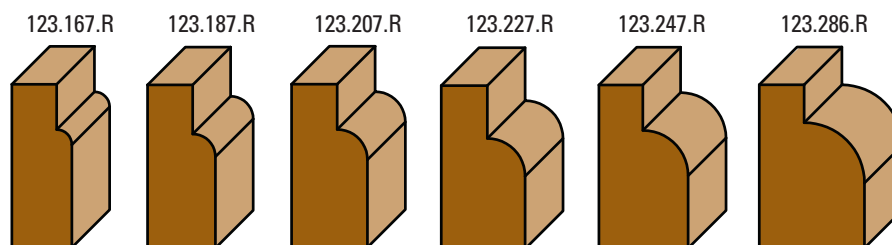

Scale 1:1

6 PIECE DOVETAIL BITS "STARTER SET"

ART. X012



- Set including the 6 most popular T.C.T. router bits in a robust and practical wooden box.
- Ideal to have the right bit for straight cuts and dovetail joints.

Item		
X012.006.R (S Ø 6) NEW	X012.064.R (Ø 6,4 (1/4")) NEW	X012.008.R (S Ø 8) NEW
6-pcs router bit set:	6-pcs router bit set:	6-pcs router bit set:
A101.060.R	B101.060.R	C101.060.R
A102.080.R	B102.080.R	C102.080.R
A108.064.R	B108.064.R	C108.064.R
A108.095.R	B108.095.R	C108.095.R
A108.150.R	B108.150.R	C108.150.R
A108.190.R	B108.190.R	C108.190.R

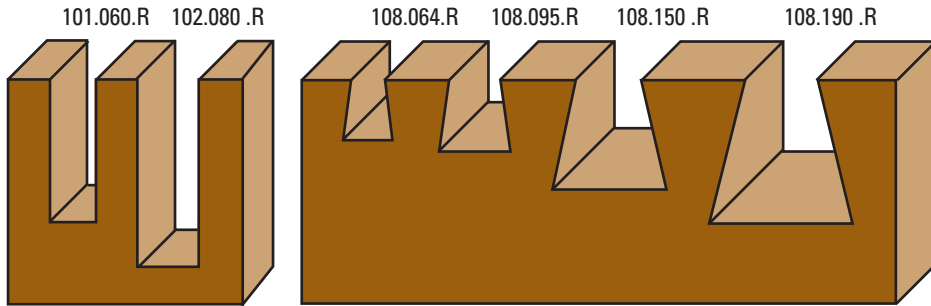

Scale 1:1

12 PIECE CLASSICAL ROUTER BITS "STARTER SET"

ART. X005



- Set including the 12 most popular T.C.T. router bits in a robust and practical wooden box.
- Ideal to have always on hand the right bit for straight cuts, trimming, engraving and profiling.

Item		
X005.006.R (S Ø 6)	X005.064.R (Ø 6,4 (1/4"))	X005.008.R (S Ø 8)
12-pcs router bit set:	12-pcs router bit set:	12-pcs router bit set:
A101.060.R	B101.064.R	C101.060.R
A101.120.R	B101.127.R	C101.120.R
A101.200.R	B101.190.R	C101.200.R
A105.064.R	B105.064.R	C105.064.R
A108.127.R	B108.127.R	C108.127.R
A109.127.R	B109.127.R	C109.127.R
A111.127.R	B111.127.R	C111.127.R
A119.127.R	B119.127.R	C119.127.R
A122.317.R	B122.317.R	C122.317.R
A123.254.R	B123.254.R	C123.254.R
A125.254.R	B125.254.R	C125.254.R
A127.254.R	B127.254.R	C127.254.R

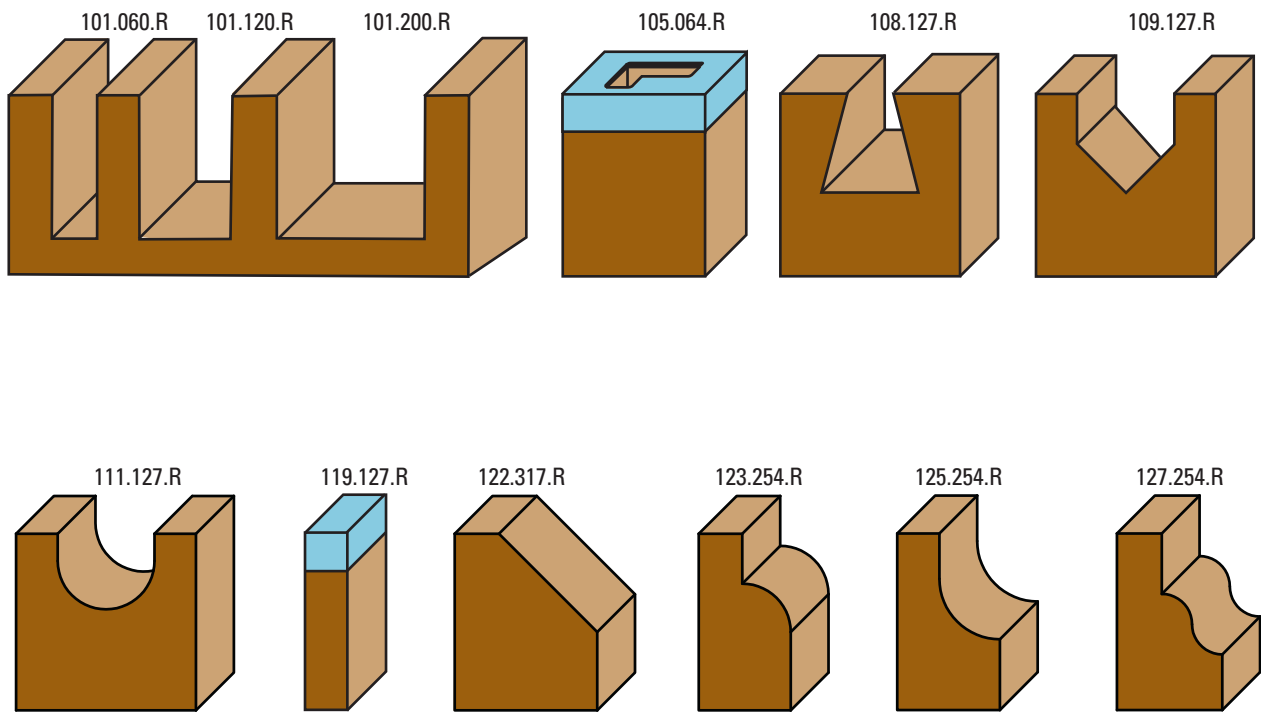

Scale 1:1

12 PIECE STRAIGHT BITS "ADVANCED SET"

ART. X006



- Set including the 12 most popular T.C.T. router bits in a robust and practical wooden box.
- Ideal to have always on hand the right bit for straight cuts.

Item		
X006.006.R (S Ø 6) NEW	X006.064.R (Ø 6,4 (1/4")) NEW	X006.008.R (S Ø 8) NEW
12-pcs router bit set:	12-pcs router bit set:	12-pcs router bit set:
A101.030.R	B101.030.R	C101.030.R
A101.040.R	B101.040.R	C101.040.R
A101.060.R	B101.060.R	C101.060.R
A101.080.R	B101.080.R	C101.080.R
A101.100.R	B101.100.R	C101.100.R
A101.120.R	B101.120.R	C101.120.R
A102.060.R	B102.060.R	C102.060.R
A102.080.R	B102.080.R	C102.080.R
A102.100.R	B102.100.R	C102.100.R
A103.080.R	B103.080.R	C103.080.R
A103.100.R	B103.100.R	C103.100.R
A103.120.R	B103.120.R	C103.120.R

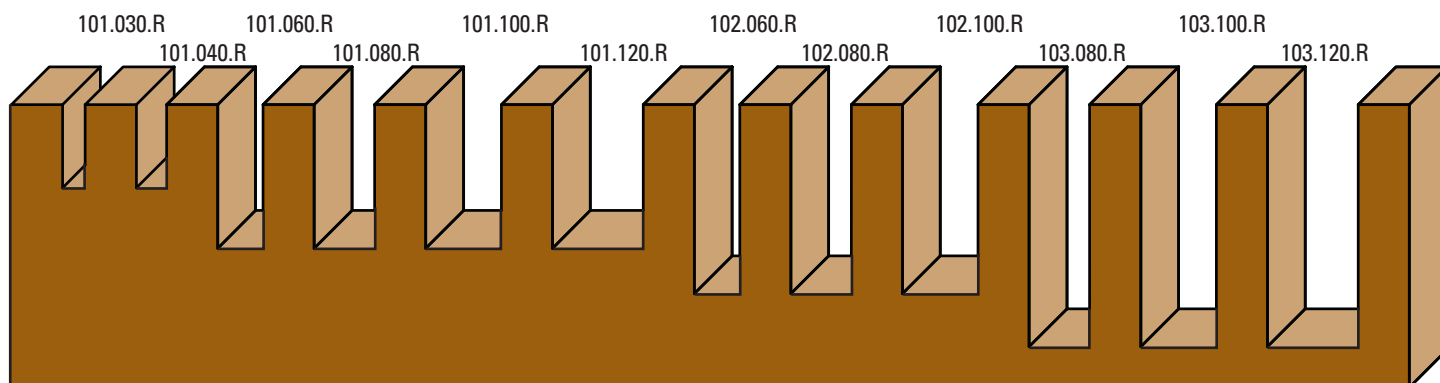

Scale 1:1

12 PIECE PROFILE INSERT ROUTER BITS "ADVANCED SET"

ART. X007



- Set including the 12 most popular T.C.T. router bits in a robust and practical wooden box.
- Ideal to have always on hand the right bit for trimming and profiling.

Item		
X007.006.R (S Ø 6) NEW	X007.064.R (Ø 6,4 (1/4")) NEW	X007.008.R (S Ø 8) NEW
12-pcs router bit set:	12-pcs router bit set:	12-pcs router bit set:
A119.190.R	B119.190.R	C119.190.R
A120.127.R	B120.127.R	C120.127.R
A121.317.R	B121.317.R	C121.317.R
A122.317.R	B122.317.R	C122.317.R
A123.167.R	B123.167.R	C123.167.R
A123.187.R	B123.187.R	C123.187.R
A123.207.R	B123.207.R	C123.207.R
A123.227.R	B123.227.R	C123.227.R
A123.247.R	B123.247.R	C123.247.R
A123.286.R	B123.286.R	C123.286.R
A125.254.R	B125.254.R	C125.254.R
A127.254.R	B127.254.R	C127.254.R

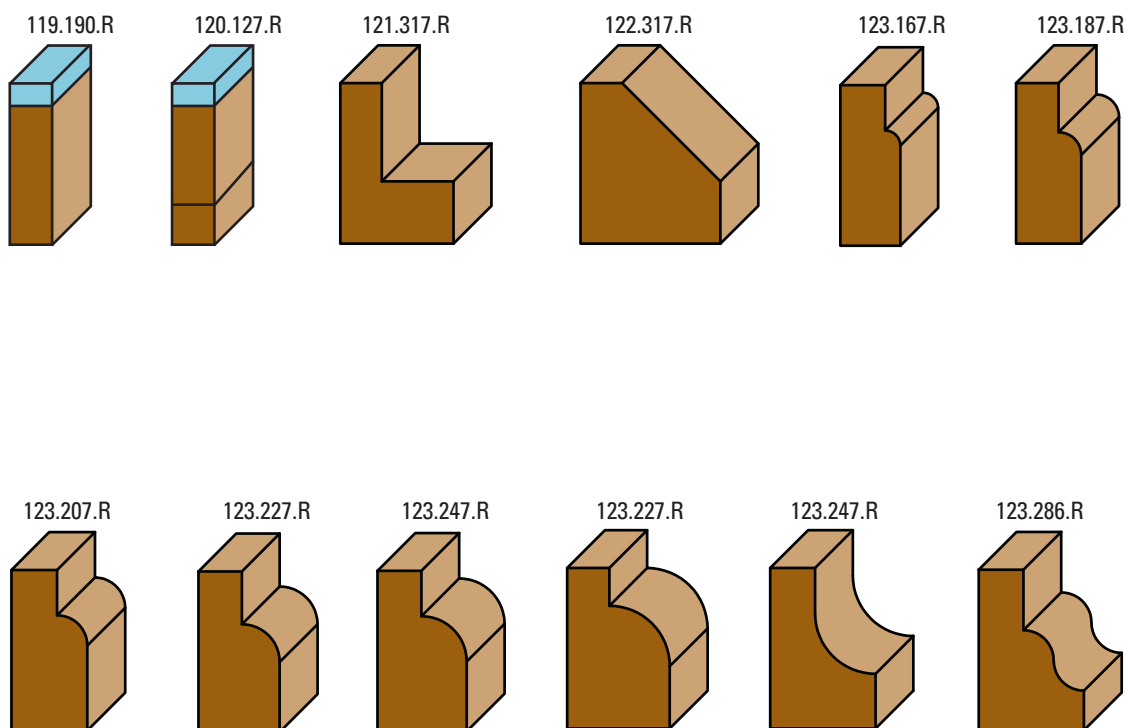

Scale 1:1

12 PIECE DOVETAIL BITS "ADVANCED SET"

ART. X008



- Set including the 12 most popular T.C.T. router bits in a robust and practical wooden box.
- Ideal to have the right bit for straight cuts and dovetail joints.

Item		
X008.006.R (S Ø 6) NEW	X008.064.R (Ø 6,4 (1/4")) NEW	X008.008.R (S Ø 8) NEW
12-pcs router bit set:	12-pcs router bit set:	12-pcs router bit set:
A101.030.R	B101.030.R	C101.030.R
A101.040.R	B101.040.R	C101.040.R
A102.060.R	B102.060.R	C102.060.R
A102.080.R	B102.080.R	C102.080.R
A108.064.R	B108.064.R	C108.064.R
A108.080.R	B108.080.R	C108.080.R
A108.095.R	B108.095.R	C108.095.R
A108.127.R	B108.127.R	C108.127.R
A108.143.R	B108.143.R	C108.143.R
A108.150.R	B108.150.R	C108.150.R
A108.160.R	B108.160.R	C108.160.R
A108.190.R	B108.190.R	C108.190.R

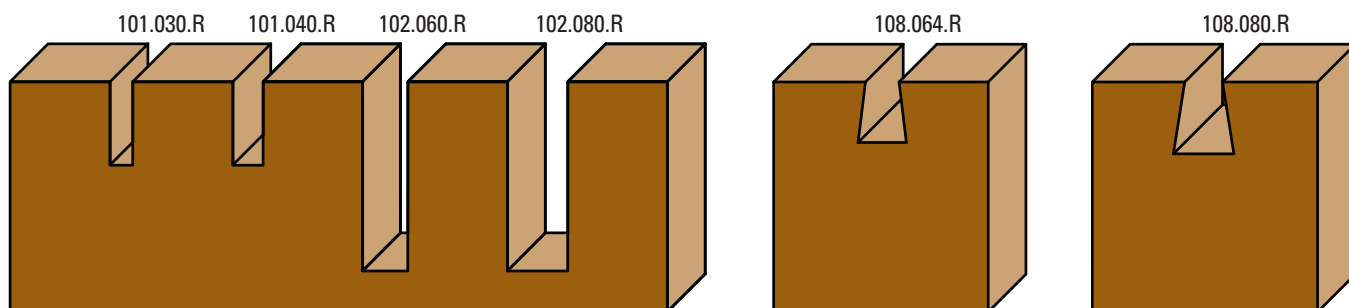

Scale 1:1

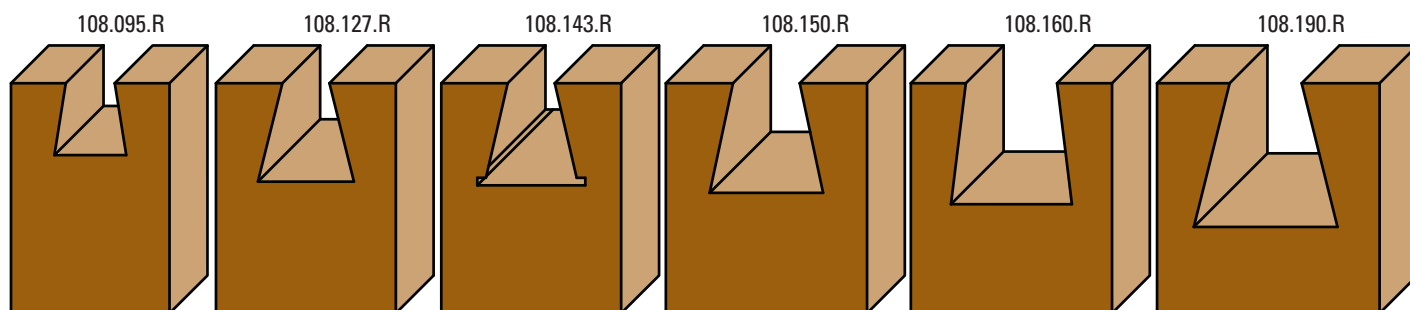

Scale 1:1

12 PIECE CORNER ROUNDING BITS "ADVANCED SET"

ART. X013



- Set including the 12 most popular T.C.T. router bits in a robust and practical wooden box.
- Ideal to have always on hand the right bit to produce corner roundings.

Item		
X013.006.R (S Ø 6) NEW	X013.064.R (Ø 6,4 (1/4")) NEW	X013.008.R (S Ø 8) NEW
12-pcs router bit set:	12-pcs router bit set:	12-pcs router bit set:
A123.160.R	B123.160.R	C123.160.R
A123.167.R	B123.167.R	C123.167.R
A123.187.R	B123.187.R	C123.187.R
A123.190.R	B123.190.R	C123.190.R
A123.207.R	B123.207.R	C123.207.R
A123.222.R	B123.222.R	C123.222.R
A123.227.R	B123.227.R	C123.227.R
A123.247.R	B123.247.R	C123.247.R
A123.254.R	B123.254.R	C123.254.R
A123.286.R	B123.286.R	C123.286.R
A123.318.R	B123.318.R	C123.318.R
A123.327.R	B123.327.R	C123.327.R

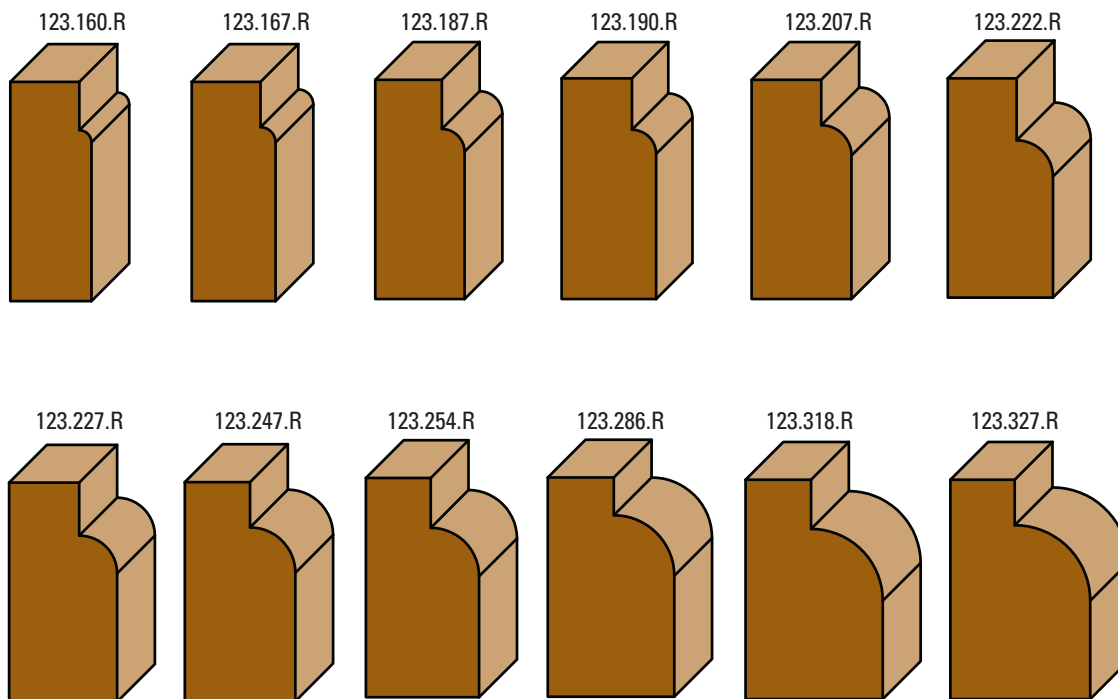

Scale 1:1

6 PIECE INSERT ROUTER BITS "SET"

ART. XWC



- Set including the 6 most popular HW router bits in S=8 in a robust and practical wooden box.
- Ideal to have always on hand the right bit for straight cuts, trimming and engraving.
- Router bits complete with reversible knives

Item

XWC.001.R

6-pcs router bit set:

WC101.120.R

WC109.176.R

WC111.127.R

WC120.127.R

WC121.286.R

WC122.273.R

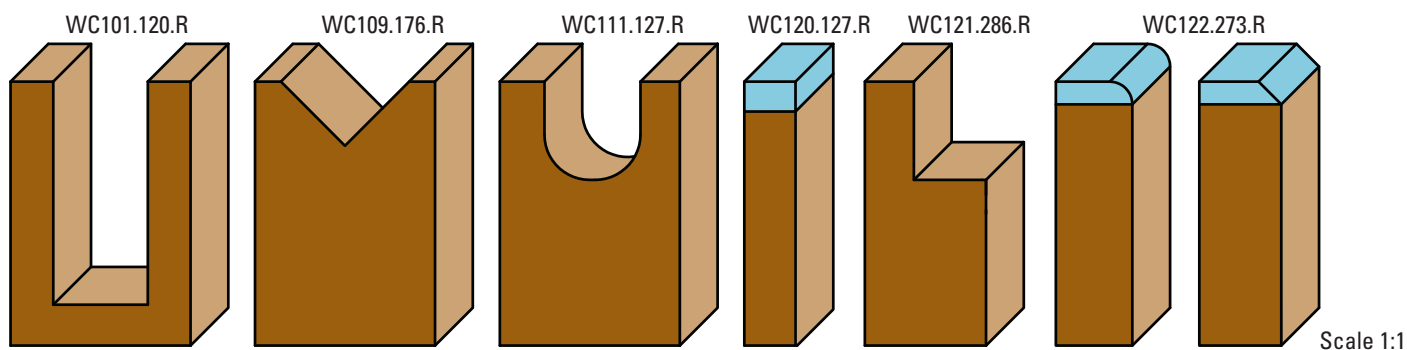

6 PIECE INSERT ROUTER BITS "SET"

ART. XWC



- Set including the 6 most popular HW router bits in S=8 in a robust and practical wooden box.
- Ideal to have always on hand the right bit for trimming and profiling.
- Router bits complete with reversible knives

Item

XWC.002.R

6-pcs router bit set:

WC120.127.R

WC121.286.R

WC122.273.R

WC123.260.R

WC125.260.R

WC129.260.R

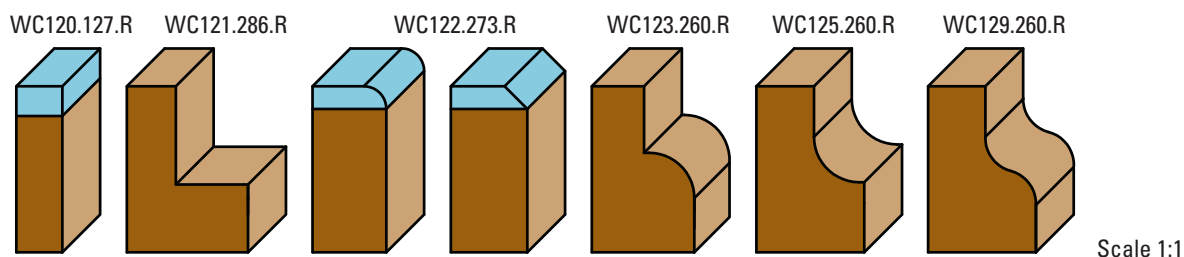

Router bits for hand portable machines

S=Ø10 - S=Ø12 - S=Ø12,7 (1/2")



2



HW STRAIGHT BITS S=10
Page 2.05



HW STRAIGHT BITS S=10 LONG TYPE
Page 2.05



HW STRAIGHT BITS S=12
Page 2.05



HW STRAIGHT BITS Z=2
Page 2.05



HW STRAIGHT BITS Z=2 LONG TYPE
Page 2.06

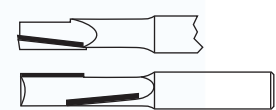

HW STAGGER BITS Z=2
Page 2.06



HW PANEL PILOT BITS Z=1+1
Page 2.06



HW PLUNGE TYPE OGEE BITS Z=2
Page 2.06

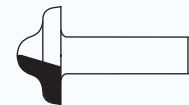

HW PLUNGE TYPE OGEE BITS Z=2
Page 2.06

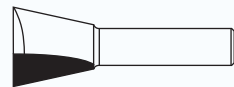

HW DOVETAIL BITS Z=2
Page 2.06

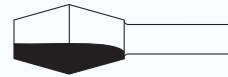

HW 14° BUTTERFLY SPLINE BITS Z=2
Page 2.07



HW V-GROOVE BITS Z=2
Page 2.07



HW CORE BOX BITS Z=2
Page 2.07

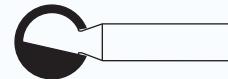

HW BALL AND PLUNGE BITS Z=2
Page 2.07

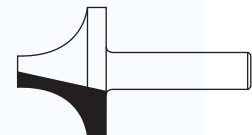

HW PLUNGING ROUND-OVER
BITS Z=2
Page 2.07

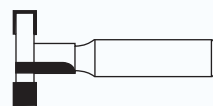

HW T-SLOT ROUTER BITS Z=2
Page 2.07

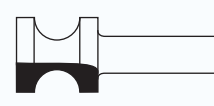

HW BULL NOSE RADIUS BITS Z=2
Page 2.08

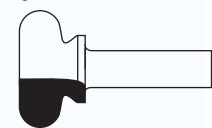

HW FINGER GRIP BITS Z=2
Page 2.08



HW EDGE BEADING BITS Z=2
Page 2.08

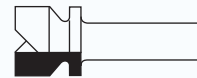

HW FINGER GRIP BITS Z=2
Page 2.08



HW DRAWER LOCK BITS Z=2
Page 2.08

Klein®

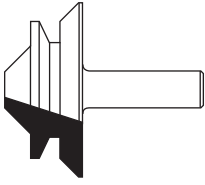

HW 45° LOCK MITRE BITS Z=2
Page 2.08

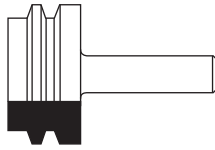

HW GLUE JOINT BITS Z=2
Page 2.08

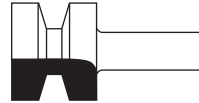

HW WEDGE TONGUE
AND GROOVE BITS Z=2
Page 2.09

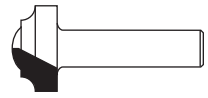

HW PROFILE BITS Z=2
Page 2.09



HW CROWN MOULDING BITS Z=2
Page 2.09



HW CROWN MOULDING BITS Z=2
Page 2.09



HW CROWN MOULDING BITS Z=2
Page 2.09

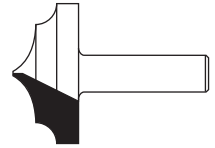

HW PROFILE BITS Z=2
Page 2.09

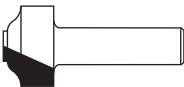

HW PROFILE BITS Z=2
Page 2.09

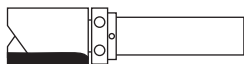

HW FLUSH TRIM BITS WITH
UPPER BALL BEARING GUIDE Z=2
Page 2.10

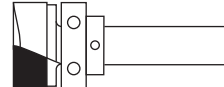

HW PLUNGE BITS WITH
UPPER BALL BEARING GUIDE Z=2
Page 2.10

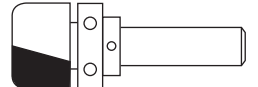

HW BOWL AND TRAY BITS WITH
UPPER BALL BEARING GUIDE Z=2
Page 2.10

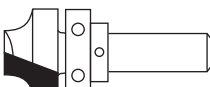

HW BEADING BITS WITH
UPPER BALL BEARING GUIDE Z=2
Page 2.10

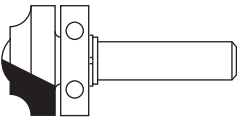

HW CLASSICAL PLUNGE BITS WITH
UPPER BALL BEARING GUIDE Z=2
Page 2.10

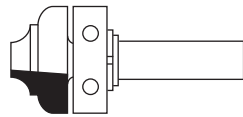

HW CLASSICAL PLUNGE BITS WITH
UPPER BALL BEARING GUIDE Z=2
Page 2.11

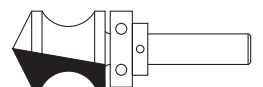

HW HAND GRIP PLUNGE BITS WITH
UPPER BALL BEARING GUIDE Z=2
Page 2.11

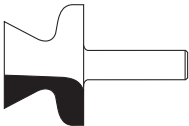

HW WINDOW SILL EDGE BITS Z=2
Page 2.11

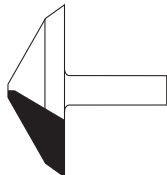

HW RAISED PANEL BITS Z=2
Page 2.11

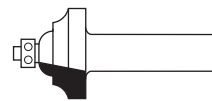

HW DOUBLE RADIUS BITS Z=2
Page 2.11



HW COVE BITS Z=2
Page 2.11



HW FLAT SUNK BEAD BITS Z=2
Page 2.12



HW SUNK BEAD BITS Z=2
Page 2.12

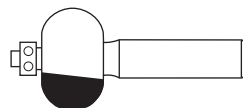

HW SUNK BEAD BITS Z=2
Page 2.12



HW FLAT ROUNDING-OVER BITS Z=2
Page 2.12



HW SUNK BEAD BITS Z=2
Page 2.12



HW FLUSH TRIM BITS WITH
BALL BEARING GUIDE Z=2
Page 2.12

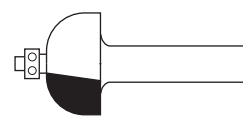

HW COVE BITS WITH
BALL BEARING GUIDE
Page 2.13



HW ROMAN OGEE BITS WITH
BALL BEARING GUIDE Z=2
Page 2.13

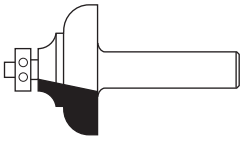

HW CLASSICAL Ogee BITS WITH BALL BEARING GUIDE Z=2
Page 2.13



HW RABBETING BITS WITH BALL BEARING GUIDE Z=2
Page 2.13

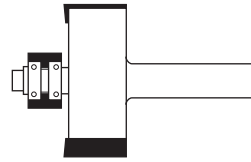

HW RABBETING BITS WITH BALL BEARING GUIDE Z=2
Page 2.14

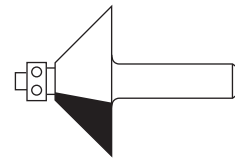

HW BEVEL TRIM BITS WITH BALL BEARING GUIDE Z=2
Page 2.14

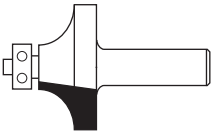

HW CORNER ROUNDING BITS WITH BALL BEARING GUIDE Z=2
Page 2.14

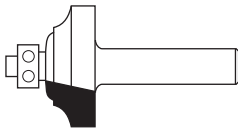

HW CLASSICAL BITS WITH BALL BEARING GUIDE Z=2
Page 2.14

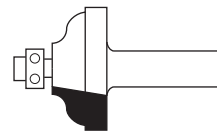

HW Ogee BITS WITH BALL BEARING GUIDE Z=2
Page 2.15

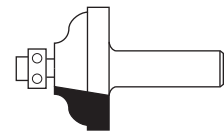

HW MOULDING BITS WITH BALL BEARING GUIDE Z=2
Page 2.15

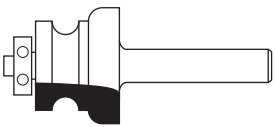

HW MOULDING BITS WITH BALL BEARING GUIDE Z=2
Page 2.15

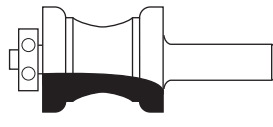

HW MOULDING BITS WITH BALL BEARING GUIDE Z=2
Page 2.15

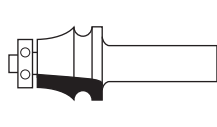

HW DRAWING LINE BITS WITH BALL BEARING GUIDE Z=2
Page 2.15

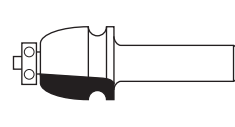

HW DRAWING LINE BITS WITH BALL BEARING GUIDE Z=2
Page 2.15



HW DRAWING LINE BITS WITH BALL BEARING GUIDE Z=2
Page 2.16



HW ARCHITECTURAL MOULDING LINE BITS WITH BALL BEARING GUIDE Z=2
Page 2.16



HW ARCHITECTURAL MOULDING LINE BITS WITH BALL BEARING GUIDE Z=2
Page 2.16



HW ARCHITECTURAL MOULDING LINE BITS WITH BALL BEARING GUIDE Z=2
Page 2.16



HW MULTI RADIUS BITS Z=2
Page 2.16

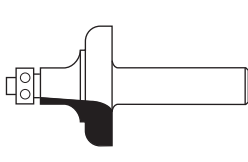

HW MULTIPLE PROFILE BITS Z=2
Page 2.16

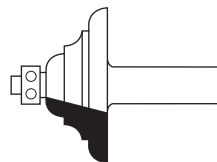

HW MULTIPLE PROFILE BITS Z=2
Page 2.17

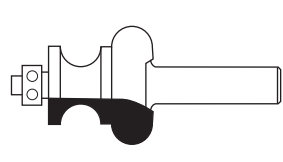

HW MULTIPLE PROFILE BITS Z=2
Page 2.17

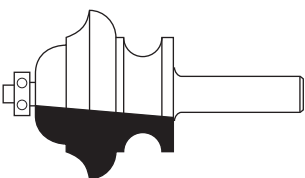

HW CLASSICAL MULTI-FORM BITS WITH BALL BEARING GUIDE Z=2
Page 2.17

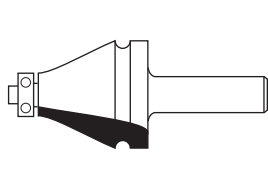

HW HANDRAIL BITS WITH BALL BEARING GUIDE Z=2
Page 2.17

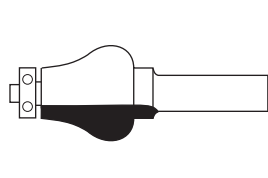

HW HANDRAIL BITS WITH BALL BEARING GUIDE Z=2
Page 2.18

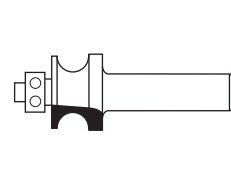

HW EDGE BEADING BITS Z=2
Page 2.18

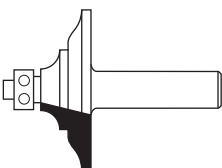

HW HANDRAIL AND TABLE EDGE BITS Z=2
Page 2.18

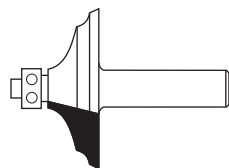

HW HANDRAIL AND TABLE EDGE BITS Z=2
Page 2.18

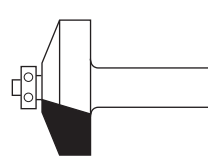

HW RAISED PANEL BITS WITH BALL BEARING GUIDE Z=2
Page 2.18

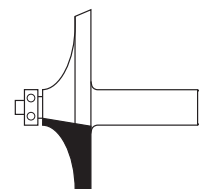

HW HANDRAIL-TABLE EDGE BITS WITH BALL BEARING GUIDE Z=2
Page 2.18

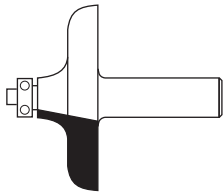

HW HANDRAIL-TABLE EDGE BITS
WITH BALL BEARING GUIDE Z=2
Page 2.19

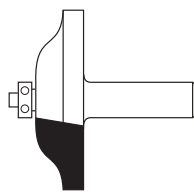

HW RAISED PANEL BITS WITH
BALL BEARING GUIDE Z=2
Page 2.19

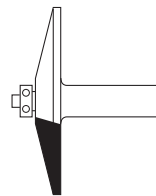

HW RAISED PANEL BITS WITH
BALL BEARING GUIDE Z=2
Page 2.19

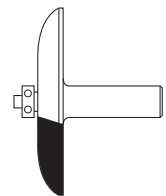

HW RAISED PANEL BITS WITH
BALL BEARING GUIDE Z=2
Page 2.19

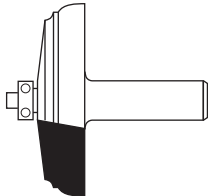

HW RAISED PANEL BITS WITH
BALL BEARING GUIDE Z=2
Page 2.19

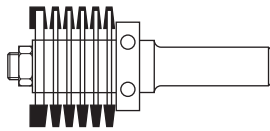

HW FINGER JOINT ASSEMBLY
WITH BALL BEARING GUIDE Z=2
Page 2.20

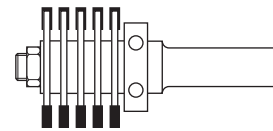

HW FINGER JOINT ASSEMBLY
WITH BALL BEARING GUIDE Z=3
Page 2.20

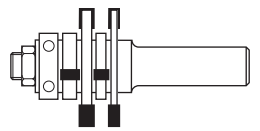

HW SLOT CUTTER SET WITH
BALL BEARING GUIDE Z=2
Page 2.21

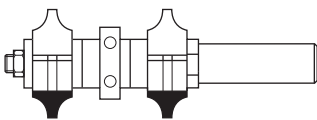

HW DOUBLE CORNER ROUND ASSEMBLY
WITH BALL BEARING GUIDE Z=3
Page 2.21

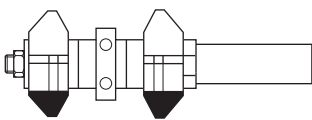

HW DOUBLE CHAMFER ASSEMBLY
WITH BALL BEARING GUIDE Z=3
Page 2.22

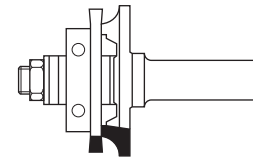

HW BEAD PANELING ASSEMBLY
WITH BALL BEARING GUIDE Z=2
Page 2.22

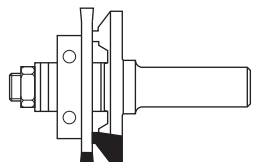

HW V PANELING ASSEMBLY
WITH BALL BEARING GUIDE Z=2
Page 2.23

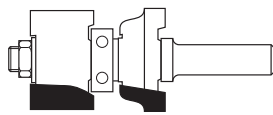

HW OGEE WINDOW SASH ASSEMBLY
WITH BALL BEARING GUIDE Z=2
Page 2.23

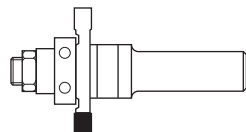

HW TONGUE AND GROOVE ASSEMBLY
WITH BALL BEARING GUIDE Z=2
Page 2.24

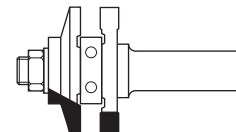

HW STILE AND RAIL ASSEMBLY
WITH BALL BEARING GUIDE Z=2
Page 2.24

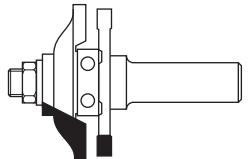

HW STILE AND RAIL ASSEMBLY
WITH BALL BEARING GUIDE Z=2
Page 2.25

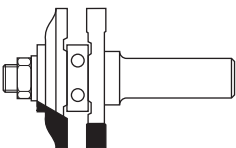

HW STILE AND RAIL ASSEMBLY
WITH BALL BEARING GUIDE Z=2
Page 2.25

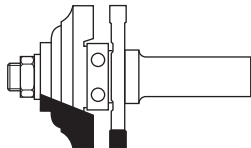

HW STILE AND RAIL ASSEMBLY
WITH BALL BEARING GUIDE Z=2
Page 2.26

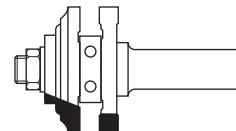

HW STILE AND RAIL ASSEMBLY
WITH BALL BEARING GUIDE Z=2
Page 2.26



HW BEADING BITS FOR RADIUS
WINDOW Z=2
Page 2.27



2 PIECE SET FOR CABINET DOORS
MAKER "TYPE 1"
Page 2.28



2 PIECE SET FOR CABINET DOORS
MAKER "TYPE 2"
Page 2.28



2 PIECE SET FOR CABINET DOORS
MAKER "TYPE 3"
Page 2.29



3 PIECE SET FOR CABINET DOORS
MAKER AND JOINTS "TYPE 1"
Page 2.29



3 PIECE SET FOR CABINET DOORS
MAKER AND JOINTS "TYPE 2"
Page 2.30



3 PIECE SET FOR CABINET DOORS
MAKER AND JOINTS "TYPE 3"
Page 2.30

HW STRAIGHT BITS S=10

ART. D101

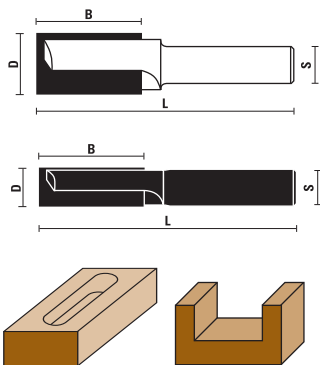

- Straight cut Z=2+1, plunging
- To be used also for working plastic materials, acrylic, polypropylene, HDPE, acetates and polycarbonates
- Also for C.N.C. machines

S Ø 10	D	B	L
D101.040.R ▲	4	13	49
D101.050.R ▲	5	15	49
D101.060.R ▲	6	16	53
D101.070.R ▲	7	20	55
D101.080.R ▲	8	23	60
D101.090.R ▲ NEW	9	23	60
D101.100.R ▲	10	23	70
D101.120.R	12	23	70
D101.140.R	14	23	70
D101.150.R	15	23	70
D101.160.R	16	23	70
D101.180.R	18	23	70
D101.200.R	20	23	70
D101.220.R	22	23	70
D101.240.R	24	23	70

▲ Solid carbide

HW STRAIGHT BITS S=10 LONG TYPE

ART. D102

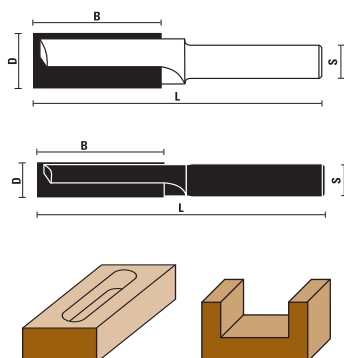

- Straight cut Z=2+1, plunging
- To be used also for working plastic materials, acrylic, polypropylene, HDPE, acetates and polycarbonates
- Also for C.N.C. machines

S Ø 10	D	B	L
D102.100.R ▲	10	40	87
D102.120.R	12	40	87
D102.140.R	14	40	87
D102.160.R	16	45	87
D102.180.R	18	45	87
D102.200.R	20	45	87

▲ Solid carbide

HW STRAIGHT BITS S=12

ART. D103

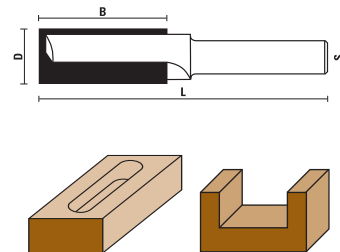

- Straight cut Z=2+1, plunging
- To be used also for working plastic materials, acrylic, polypropylene, HDPE, acetates and polycarbonates
- Also for C.N.C. machines

S Ø 12	D	B	L
D103.100.R	10	35	90
D103.120.R	12	35	90
D103.121.R	12	45	90
D103.140.R	14	35	90
D103.141.R	14	50	100
D103.160.R	16	35	90
D103.161.R	16	50	100
D103.180.R	18	35	90
D103.181.R	18	50	100
D103.200.R	20	35	90
D103.201.R	20	50	100
D103.220.R	22	35	90
D103.240.R	24	35	90

HW STRAIGHT BITS Z=2

ART. E101 - G101

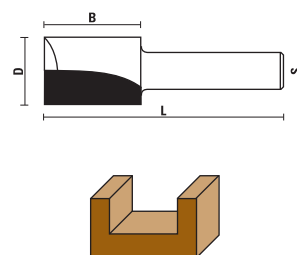

S Ø 12	S Ø 12,7 (1/2")	D	B	L
E101.040.R		4	11	63
E101.050.R		5	11	60
E101.060.R	G101.060.R	6	19	63
	G101.064.R	6,4	19	63
E101.070.R		7	19	63
E101.080.R	G101.080.R	8	19	63
	G101.095.R	9,5	25	70
E101.100.R	G101.100.R	10	25	70
E101.120.R		12	25	70
	G101.127.R	12,7	25	66
E101.140.R		14	32	73
	G101.143.R	14,3	32	73
E101.150.R		15	25	66
E101.160.R	G101.160.R	16	32	73
E101.170.R		17	32	73
	G101.175.R	17,5	32	73
E101.180.R		18	32	73
E101.200.R		20	32	73
E101.220.R		22	32	73
E101.250.R		25	32	73
	G101.254.R	25,4	32	73
E101.300.R		30	32	73
E101.350.R		35	32	73
E101.400.R		40	32	73

HW STRAIGHT BITS Z=2 LONG TYPE

ART. E102 - G102 / E103 - G103

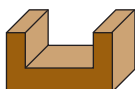
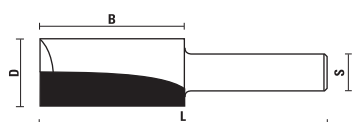

S Ø 12	S Ø 12,7 (1/2")	D	B	L
E102.080.R		8	25	70
	G102.095.R	9,5	32	76
E102.100.R	G102.100.R	10	32	76
E102.120.R	G102.120.R	12	38	80
	G102.127.R	12,7	38	80
E102.160.R	G102.160.R	16	38	80
E102.190.R	G102.190.R	19	38	80
<hr/>				
E103.120.R	G103.120.R	12	50	108
	G103.127.R	12,7	50	108
E103.180.R		18	50	92
E103.200.R		20	50	92
E103.220.R		22	50	92

HW STAGGER BITS Z=2

ART. E104 - G104

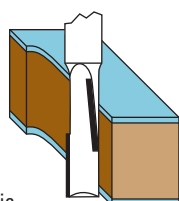
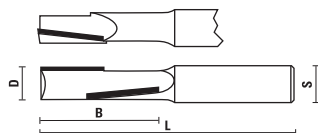

- Excellent for working laminated, panel, melaminic, veneered and plywood
- Good finishing top/bottom

S Ø 12	S Ø 12,7 (1/2")	D	B	L
E104.127.R	G104.127.R	12,7	38	79
E104.128.R	G104.128.R	12,7	54	108

HW PANEL PILOT BITS Z=1+1

ART. E105 - G105

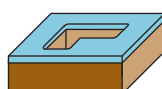
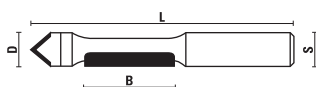

S Ø 12	S Ø 12,7 (1/2")	D	B	L
E105.127.R	G105.127.R	12,7	30	90

HW PLUNGE TYPE OGEE BITS Z=2

ART. E106 - G106

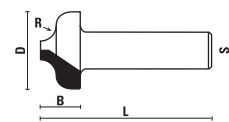

S Ø 12	S Ø 12,7 (1/2")	D	R	B	L
E106.190.R	G106.190.R	19	3,5	13	68
E106.254.R	G106.254.R	25,4	3,2	9,5	50
E106.350.R	G106.350.R	35	3,2	9,5	59

HW PLUNGE TYPE OGEE BITS Z=2

ART. E107 - G107

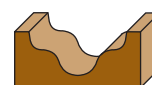
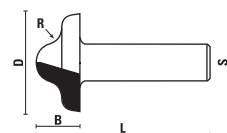

S Ø 12	S Ø 12,7 (1/2")	D	R	B	L
E107.270.R	G107.270.R	27	6	12	57

HW DOVETAIL BITS Z=2

ART. E108 - G108

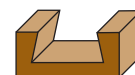
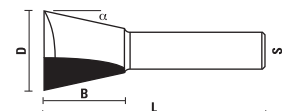

S Ø 12	S Ø 12,7 (1/2")	D	α	B	L
E108.160.R	G108.160.R	16	7°	16	59
E108.161.R	G108.161.R	16	7°	22	65
E108.190.R	G108.190.R	19	14°	19	65
E108.191.R	G108.191.R	19	7°	22	65
E108.220.R	G108.220.R	22	14°	22	67
E108.221.R	G108.221.R	22	7°	22	60
E108.254.R	G108.254.R	25,4	14°	25,4	70

HW 14° BUTTERFLY SPLINE BITS Z=2

ART. E109 - G109

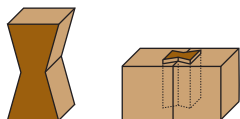
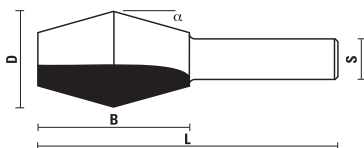

S Ø 12	S Ø 12,7 (1/2")	D	α	B	L
E109.280.R	G109.280.R	28	14°	46	84

HW V-GROOVE BITS Z=2

ART. E110 - G110

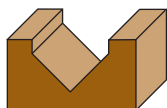
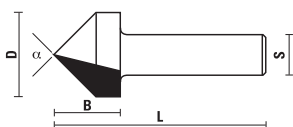

S Ø 12	S Ø 12,7 (1/2")	D	α	B	L
E110.127.R	G110.127.R	12,7	90°	13	54
E110.160.R	G110.160.R	16	90°	13	51
E110.190.R	G110.190.R	19	90°	16	54
E110.254.R	G110.254.R	25,4	90°	19	57
E110.320.R	G110.320.R	32	90°	25	64
E110.381.R	G110.381.R	38,1	90°	32	70
E110.501.R	G110.501.R	51	90°	44	83

HW CORE BOX BITS Z=2

ART. E111 - G111

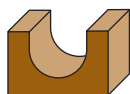
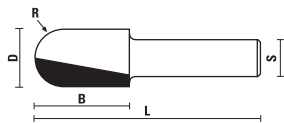

S Ø 12	S Ø 12,7 (1/2")	D	R	B	L
E111.127.R	G111.127.R	12,7	6,4	32	73
E111.160.R	G111.160.R	16	8	32	70
E111.190.R	G111.190.R	19	9,5	32	70
E111.220.R	G111.220.R	22	11	32	70
E111.254.R	G111.254.R	25,4	12,7	32	70
E111.317.R	G111.317.R	32	16	32	70
E111.380.R	G111.380.R	38	19	32	70
E111.500.R	G111.500.R	50	25	32	70

HW BALL AND PLUNGE BITS Z=2

ART. E112 - G112

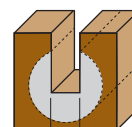
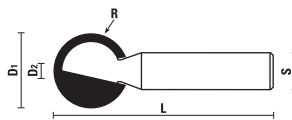

min 13



These tools can produce grooves for sliding panels or electrical wires, after a first groove which allows the tool shank moving

S Ø 12	S Ø 12,7 (1/2")	D1	D2	R	L
E112.127.R	G112.127.R	12,7	6,5	6,4	57
E112.160.R	G112.160.R	16	7,5	8	60
E112.190.R	G112.190.R	19	8,5	9,5	64
E112.254.R	G112.254.R	25,4	9	12,7	70
E112.286.R	G112.286.R	28,6	10,3	14,3	70
E112.320.R	G112.320.R	32	12,7	16	73

HW PLUNGING ROUND-OVER BITS Z=2

ART. E113 - G113

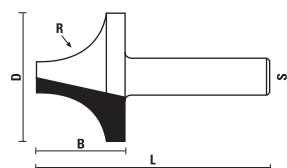

S Ø 12	S Ø 12,7 (1/2")	D	R	B	L
E113.160.R	G113.160.R	16	5	11	49
E113.190.R	G113.190.R	19	6,4	13	51
E113.220.R	G113.220.R	22	8	14	52
E113.254.R	G113.254.R	25,4	9,5	16	54
E113.349.R	G113.349.R	34,9	12,7	25,4	63,5
E113.445.R	G113.445.R	44,5	16	31,8	70
E113.510.R	G113.510.R	51	19	36	75

HW T-SLOT ROUTER BITS Z=2

ART. E114 - G114

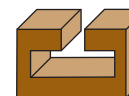
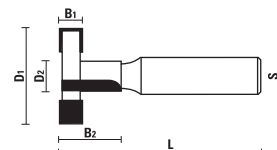

S Ø 12	S Ø 12,7 (1/2")	D1	D2	B1	B2	L
E114.280.R	G114.280.R	28	9,5	8	21	65
E114.350.R	G114.350.R	35	13	9,5	22	65

HW BULL NOSE RADIUS BITS Z=2

ART. E115 - G115

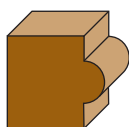
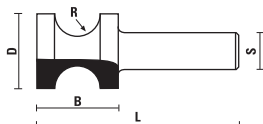

S Ø 12	S Ø 12,7 (1/2")	D	R	B	L
E115.220.R	G115.220.R	22	5	19	57
E115.260.R	G115.260.R	26	6,8	25	63
E115.280.R	G115.280.R	28	8	25	64
E115.333.R	G115.333.R	33,3	9,5	35	73
E115.429.R	G115.429.R	42,9	12,7	40	78
E115.510.R	G115.510.R	51	16	50	88
E115.600.R	G115.600.R - max RPM 18.000	60	19	50	88

HW FINGER GRIP BITS Z=2

ART. E116 - G116

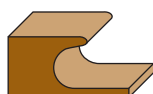
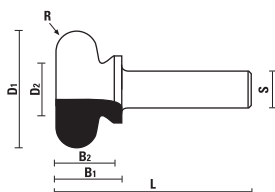

S Ø 12	S Ø 12,7 (1/2")	D1	D2	R	B1	B2	L
E116.190.R	G116.190.R	19	10	4,8	19	14	57
E116.381.R	G116.381.R	38,1	17	6	21	18	59
E116.445.R	G116.445.R	44,5	17	8	25	22	63

HW EDGE BEADING BITS Z=2

ART. E117 - G117

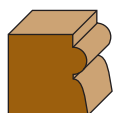
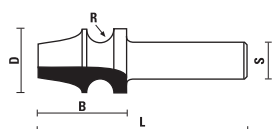

S Ø 12	S Ø 12,7 (1/2")	D	R	B	L
E117.220.R	G117.220.R	22	4	26	64

HW FINGER GRIP BITS Z=2

ART. E118 - G118

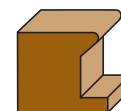
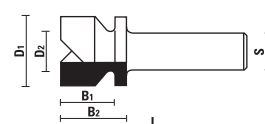

S Ø 12	S Ø 12,7 (1/2")	D1	D2	B1	B2	L
E118.220.R	G118.220.R	22	13	17	21	59

HW DRAWER LOCK BITS Z=2

ART. E119 - G119

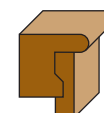
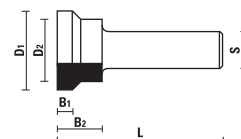

S Ø 12	S Ø 12,7 (1/2")	D1	D2	B1	B2	L
E119.254.R	G119.254.R	25,4	18,5	4	13	49

HW 45° LOCK MITRE BITS Z=2

ART. E120 - G120

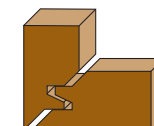
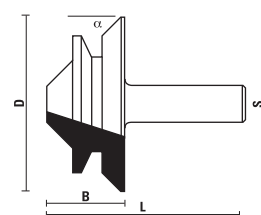

S Ø 12	S Ø 12,7 (1/2")	D	α	B	L
E120.445.R	G120.445.R	44,5	45°	20	58
E120.680.R	G120.680.R - max RPM 18.000	68	45°	29,5	68

HW GLUE JOINT BITS Z=2

ART. E121 - G121

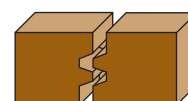
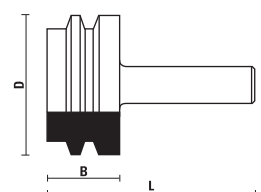

S Ø 12	S Ø 12,7 (1/2")	D	B	L
E121.470.R	G121.470.R	47	28	66

HW WEDGE TONGUE AND GROOVE BITS Z=2

ART. E122 - G122 / E123 - G123

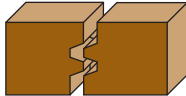
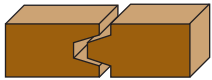
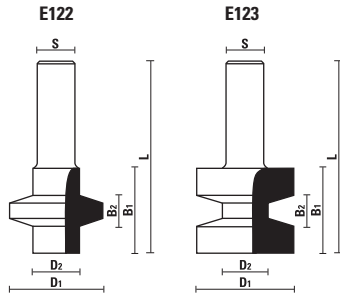

S Ø 12	S Ø 12,7 (1/2")	D1	D2	α	B1	B2	L
E122.320.R	G122.320.R	32	14	15°	32	11	70
E123.320.R	G123.320.R	32	14	15°	32	11	70

HW PROFILE BITS Z=2

ART. E124 - G124

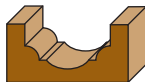
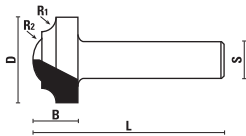
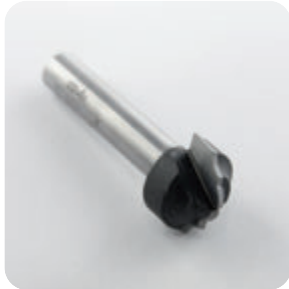

S Ø 12	S Ø 12,7 (1/2")	D	R1	R2	B	L
E124.190.R	G124.190.R	19	3,6	4	13	70
E124.254.R	G124.254.R	25,4	5	6,4	17,5	73

HW CROWN MOULDING BITS Z=2

ART. E125 - G125

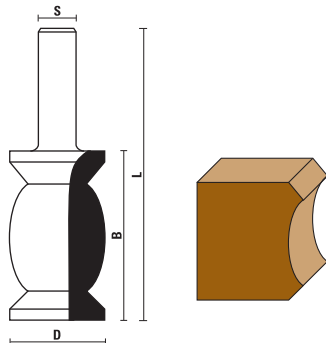

S Ø 12	S Ø 12,7 (1/2")	D	B	L
E125.320.R	G125.320.R	32	58	96

HW CROWN MOULDING BITS Z=2

ART. E126 - G126

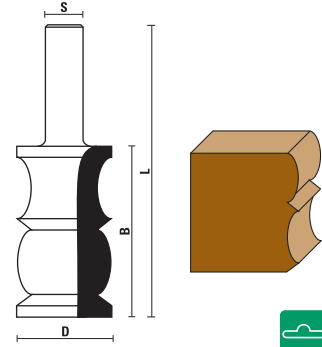

S Ø 12	S Ø 12,7 (1/2")	D	B	L
E126.320.R	G126.320.R	32	58	96

HW CROWN MOULDING BITS Z=2

ART. E127 - G127

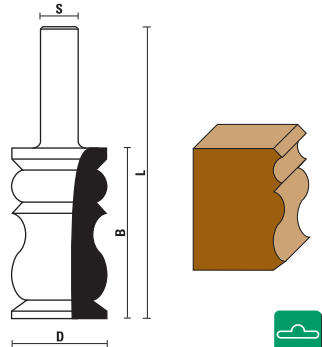

S Ø 12	S Ø 12,7 (1/2")	D	B	L
E127.320.R	G127.320.R	32	58	96

HW PROFILE BITS Z=2

ART. E128 - G128

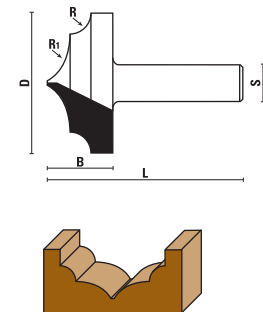

For producing ornaments

S Ø 12	S Ø 12,7 (1/2")	D	R1	R2	B	L
E128.410.R	G128.410.R	41	6,4	15	18	56

HW PROFILE BITS Z=2

ART. E129 - G129

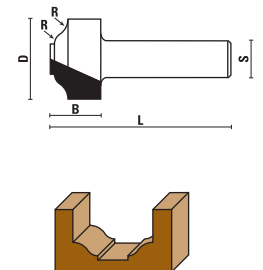

S Ø 12	S Ø 12,7 (1/2")	D	D1	R	B	L
E129.254.R	G129.254.R	25,4	9,5	4,8	15	53
E129.300.R	G129.300.R	30	12	6	15	53

HW FLUSH TRIM BITS WITH UPPER BALL BEARING GUIDE Z=2

ART. E130 - G130

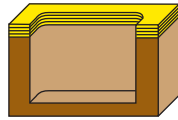
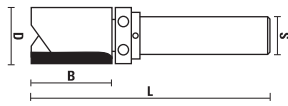

S Ø 12	S Ø 12,7 (1/2")	D	B	L
E130.190.R	G130.190.R	19	25,4	77
E130.191.R NEW	G130.191.R NEW	19	51	92



Z050.012.N



Z058.002.N



Z051.005.N

S Ø 12	S Ø 12,7 (1/2")	D	B	L
E130.254.R	G130.254.R	25,4	45	95



Z050.009.N



Z058.002.N



Z051.005.N

HW PLUNGE BITS WITH UPPER BALL BEARING GUIDE Z=2

ART. E131 - G131

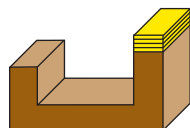
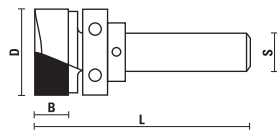

S Ø 12	S Ø 12,7 (1/2")	D	B	L
E131.190.R	G131.190.R	19	11	64



Z050.012.N



Z058.002.N



Z051.005.N

S Ø 12	S Ø 12,7 (1/2")	D	B	L
E131.254.R	G131.254.R	25,4	11	64



Z050.009.N



Z058.002.N



Z051.005.N

S Ø 12	S Ø 12,7 (1/2")	D	B	L
E131.380.R	G131.380.R	38	16	69



Z050.013.N



Z058.003.N



Z051.005.N

HW BOWL AND TRAY BITS WITH UPPER BALL BEARING GUIDE Z=2

ART. E132 - G132

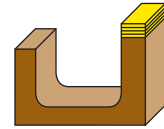
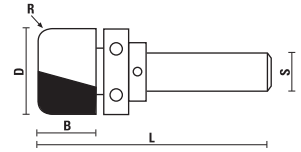

S Ø 12	S Ø 12,7 (1/2")	D	R	B	L
E132.190.R	G132.190.R	19	6,4	16	67



Z050.012.N



Z058.002.N



Z051.005.N

S Ø 12	S Ø 12,7 (1/2")	D	R	B	L
E132.286.R	G132.286.R	28,6	6,4	16	67



Z050.015.N



Z058.003.N



Z051.005.N

HW BEADING BITS WITH UPPER BALL BEARING GUIDE Z=2

ART. E133 - G133

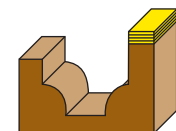
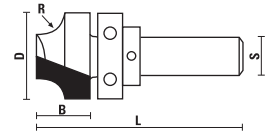

S Ø 12	S Ø 12,7 (1/2")	D	R	B	L
E133.286.R	G133.286.R	28,6	8	15	58



Z050.015.N



Z058.003.N



Z051.005.N

HW CLASSICAL PLUNGE BITS WITH UPPER BALL BEARING GUIDE Z=2

ART. E134 - G134

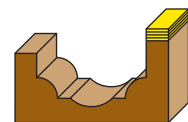
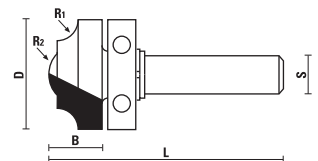

For producing ornaments

S Ø 12	S Ø 12,7 (1/2")	D	R1	R2	B	L
E134.350.R	G134.350.R	35	6,4	10	15	68



Z050.014.N



DIN 471-15

HW CLASSICAL PLUNGE BITS WITH UPPER BALL BEARING GUIDE Z=2

ART. E135 - G135

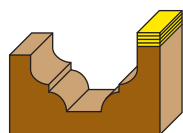
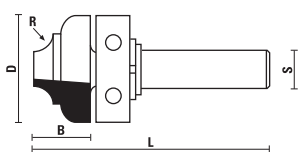

S Ø 12	S Ø 12,7 (1/2")	D	R	B	L
E135.350.R	G135.350.R	35	5	14	67



Z050.014.N



DIN 471-15

HW HAND GRIP PLUNGE BITS WITH UPPER BALL BEARING GUIDE Z=2

ART. E136 - G136

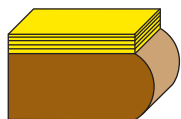
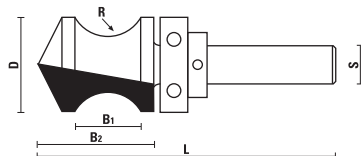

S Ø 12	S Ø 12,7 (1/2")	D	R	B1	B2	L
E136.286.R	G136.286.R	28,6	13	22	40	92



Z050.015.N



Z058.003.N



Z051.005.N

HW WINDOW SILL EDGE BITS Z=2

ART. E137 - G137

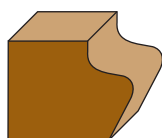
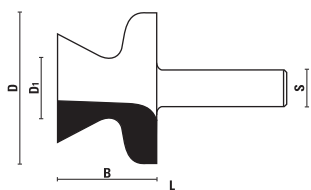

S Ø 12	S Ø 12,7 (1/2")	D	D1	B	L
E137.510.R	G137.510.R	51	19	32	70

HW RAISED PANEL BITS Z=2

ART. E138 - G138

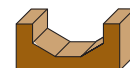
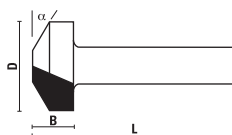
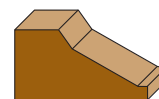
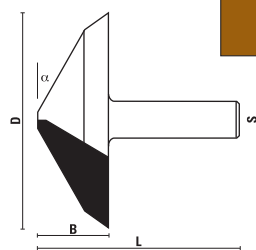

S Ø 12	S Ø 12,7 (1/2")	D	α	B	L
E138.286.R	G138.286.R	28,6	30°	13	70
E138.690.R	G138.690.R - max RPM 18.000	69	25°	19	57

HW DOUBLE RADIUS BITS Z=2

ART. E139 - G139

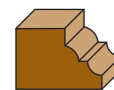
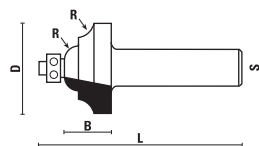

S Ø 12	S Ø 12,7 (1/2")	D	R	B	L
E139.254.R	G139.254.R	25,4	4	16	63
E139.350.R	G139.350.R	35	6,4	20	67



Z050.001.N



Z053.001.N



Z054.001.N



Z051.001.R

HW COVE BITS Z=2

ART. E140 - G140

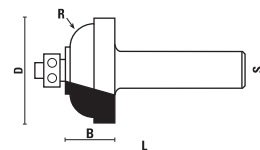

S Ø 12	S Ø 12,7 (1/2")	D	R	B	L
E140.286.R	G140.286.R	28,6	4,8	13	61
E140.350.R	G140.350.R	35	8	16	64



Z050.003.N



Z053.003.N



Z054.002.N



Z051.002.R

HW FLAT SUNK BEAD BITS Z=2

ART. E141 - G141

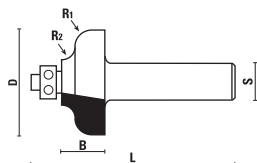

S Ø 12	S Ø 12,7 (1/2")	D	R1	R2	B	L
E141.286.R	G141.286.R	28,6	4,5	4	13	60
E141.350.R	G141.350.R	35	6	5	17,5	65



Z050.002.N



Z053.002.N



Z054.002.N



Z051.002.R

HW SUNK BEAD BITS Z=2

ART. E142 - G142

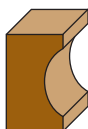
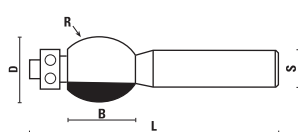

S Ø 12	S Ø 12,7 (1/2")	D	R	B	L
E142.190.R	G142.190.R	19	8	13	70
E142.220.R	G142.220.R	22	12	19	78
E142.254.R	G142.254.R	25,4	32	38	98



Z050.003.N



Z053.003.N



Z054.002.N



Z051.002.R

HW SUNK BEAD BITS Z=2

ART. E143 - G143

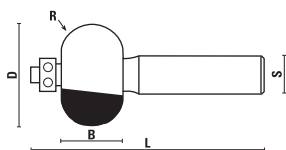

S Ø 12	S Ø 12,7 (1/2")	D	R	B	L
E143.330.R	G143.330.R	33	10	20	75



Z050.003.N



Z053.003.N



Z054.002.N



Z051.002.R

HW FLAT ROUNDING-OVER BITS Z=2

ART. E144 - G144

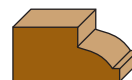
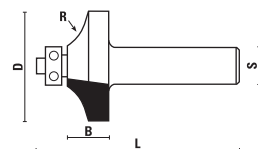

S Ø 12	S Ø 12,7 (1/2")	D	R	B	L
E144.300.R	G144.300.R	30	12	10	57



Z050.003.N



Z053.003.N



Z054.002.N



Z051.002.R

HW SUNK BEAD BITS Z=2

ART. E145 - G145

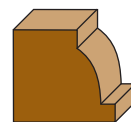
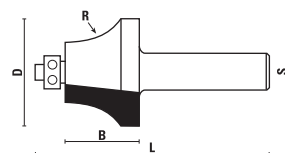

S Ø 12	S Ø 12,7 (1/2")	D	R	B	L
E145.270.R	G145.270.R	27	17	17	67



Z050.003.N



Z053.003.N



Z054.002.N



Z051.002.R

HW FLUSH TRIM BITS WITH BALL BEARING GUIDE Z=2

ART. E146 - G146

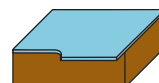
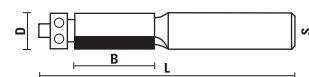

S Ø 12	S Ø 12,7 (1/2")	D	B	L
E146.126.R NEW	G146.126.R NEW	12,7	13	71
E146.127.R	G146.127.R	12,7	25	84
E146.128.R	G146.128.R	12,7	38	98
E146.129.R	G146.129.R	12,7	51	106



Z050.003.N



Z053.003.N



Z054.002.N



Z051.002.R

S Ø 12	S Ø 12,7 (1/2")	D	B	L
E146.190.R	G146.190.R	19	25	82
E146.191.R NEW	G146.191.R NEW shear angle	19	38	98
E146.192.R NEW	G146.192.R NEW shear angle	19	51	108



Z050.005.N



Z053.002.N



Z054.002.N



Z051.004.R

HW COVE BITS WITH BALL BEARING GUIDE

ART. E147 - G147

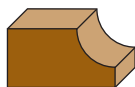
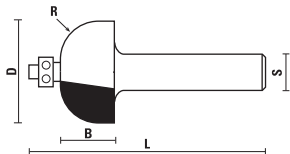

S Ø 12	S Ø 12,7 (1/2")	D	R	B	L	Z
E147.222.R	G147.222.R	22,2	6,4	14	60	2
E147.254.R	G147.254.R	25,4	8	14	60	2
E147.286.R	G147.286.R	28,6	9,5	14	62	2
E147.350.R	G147.350.R	35	12,7	17	64	2
E147.410.R	G147.410.R	41	16	18	65	2



Z050.001.N



Z053.001.N



Z054.001.N



Z051.001.R

S Ø 12	S Ø 12,7 (1/2")	D	R	B	L	Z
E147.570.R	G147.570.R	57	22	32	81	2



Z050.003.N



Z053.003.N



Z054.002.N



Z051.002.R

HW ROMAN OGEE BITS WITH BALL BEARING GUIDE Z=2

ART. E148 - G148

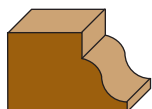
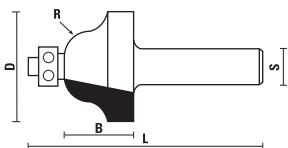

S Ø 12	S Ø 12,7 (1/2")	D	R	B	L
E148.254.R	G148.254.R	25,4	4	16	63
E148.350.R	G148.350.R	35	6,4	20	67



Z050.001.N



Z053.001.N



Z054.001.N



Z051.001.R

HW CLASSICAL OBBE BITS WITH BALL BEARING GUIDE Z=2

ART. E149 - G149

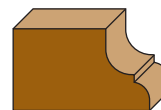
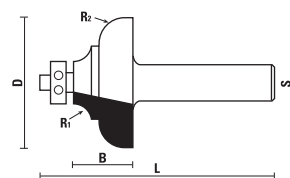

S Ø 12	S Ø 12,7 (1/2")	D	R1	R2	B	L
E149.286.R	G149.286.R	28,6	4	4	13	60
E149.350.R	G149.350.R	35	6	4,8	18	64
E149.380.R	G149.380.R	38	4,7	8	16	65
E149.510.R	G149.510.R	51	9,5	9,5	23	72



Z050.003.N



Z053.003.N



Z054.002.N



Z051.002.R

HW RABBETING BITS WITH BALL BEARING GUIDE Z=2

ART. E150 - G150

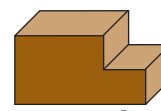
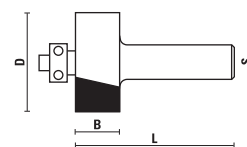

S Ø 12	S Ø 12,7 (1/2")	D	B	E	L
E150.240.R	G150.240.R	24	13	4	63
E150.320.R	G150.320.R	32	13	9,5	60
E150.350.R	G150.350.R	35	13	11	60
E150.850.R	G150.850.R	35	13	8-9,5-11-12,7	60

Art. E150.850.R/G150.850.R
Supplied with ball bearing set

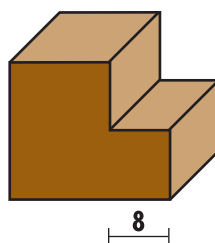

8

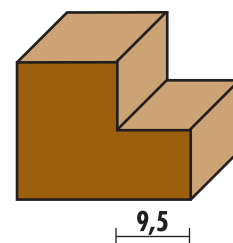

9,5

Scale 1:1

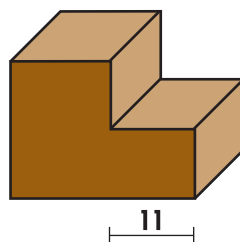

11

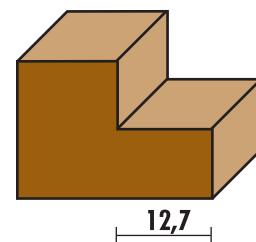

12,7

HW RABBETING BITS WITH BALL BEARING GUIDE Z=2

ART. E150 - G150

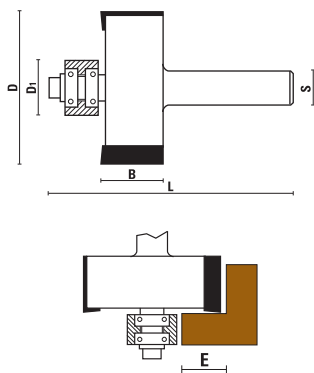

For several thickness rebates 1,6 up to 19 mm



S Ø 12	S Ø 12,7 (1/2")	D	D1	B	E	L
E150.510.R	G150.510.R	51	19	22,5	16	78



Z050.007.N



Z057.010.N



Z051.008.R

Spare rings	D1	E
Z050.901.N	14,3	18,25
Z050.902.N	16	17,5
Z050.903.N	19	16
Z050.904.N	20,6	15,2
Z050.905.N	22,2	14,3
Z050.906.N	25,4	12,7
Z050.907.N	27	12
Z050.908.N	28,6	11,1
Z050.909.N	31,8	9,5
Z050.910.N	32,5	9,25
Z050.911.N	35	8
Z050.912.N	38	6,4
Z050.913.N	39	6
Z050.914.N	41,3	4,8
Z050.915.N	44,4	3,2
Z050.916.N	47,6	1,6

Z050.999.N 16 rings set

HW BEVEL TRIM BITS WITH BALL BEARING GUIDE Z=2

ART. E151 - G151

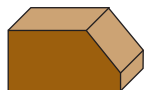
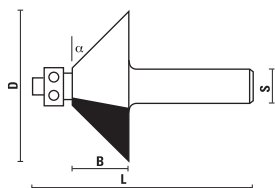

S Ø 12	S Ø 12,7 (1/2")	D	α	B	L
E151.351.R	G151.351.R	35	60°	20,6	60
E151.508.R	G151.508.R	50,8	45°	19	68
E151.635.R	G151.635.R	60,5	45°	25	74



Z050.003.N



Z053.003.N



Z054.002.N



Z051.002.R

HW CORNER ROUNDING BITS WITH BALL BEARING GUIDE Z=2

ART. E152 - G152

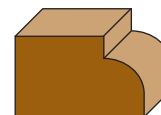
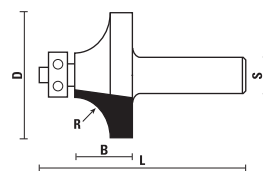

S Ø 12	S Ø 12,7 (1/2")	D	R	B	L
E152.191.R	G152.191.R	19,1	3,2	9,5	59
E152.207.R	G152.207.R	20,7	4	10	59
E152.220.R	G152.220.R	22	5	13	62
E152.254.R	G152.254.R	25,4	6,4	13	62
E152.286.R	G152.286.R	28,6	8	14	62
E152.318.R	G152.318.R	31,8	9,5	16	65
E152.327.R	G152.327.R	32,7	10	16	65
E152.367.R	G152.367.R	36,7	12	20	67
E152.380.R	G152.380.R	38	12,7	19	67
E152.410.R	G152.410.R	41	14	20	70
E152.427.R	G152.427.R	42,7	15	22	70
E152.445.R	G152.445.R	44,5	16	22,2	71
E152.487.R	G152.487.R	48,7	18	26	72
E152.508.R	G152.508.R	50,8	19	25,4	73
E152.527.R	G152.527.R	52,7	20	27	73
E152.570.R	G152.570.R	57	22	29	78
E152.635.R	G152.635.R	63,5	25	32	81
E152.700.R	G152.700.R - max RPM 18.000	70	28	35	84
E152.726.R	G152.726.R - max RPM 18.000	72,6	30	36	85
E152.760.R	G152.760.R - max RPM 18.000	76	32	38	87
E152.825.R	G152.825.R - max RPM 16.000	82,5	35	41	90
E152.890.R	G152.890.R - max RPM 16.000	89	38	45	94



Z050.003.N



Z053.003.N



Z054.002.N



Z051.002.R

Changing the ball bearing art. **Z050.003.N** with art. **Z050.002.N** the profile shown can be obtained

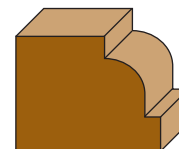

HW CLASSICAL BITS WITH BALL BEARING GUIDE Z=2

ART. E153 - G153

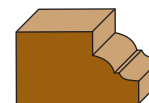
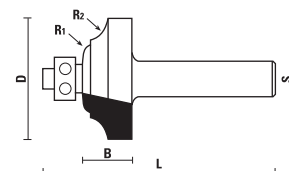

S Ø 12	S Ø 12,7 (1/2")	D	R1	R2	B	L
E153.381.R	G153.381.R	38,1	5,5	6	15,9	63,5



Z050.003.N



Z053.003.N



Z054.002.N



Z051.002.R

HW OGEE BITS WITH BALL BEARING GUIDE Z=2

ART. E154 - G154

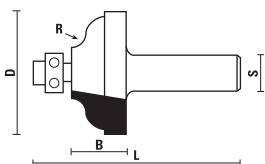

S Ø 12	S Ø 12,7 (1/2")	D	R	B	L
E154.350.R	G154.350.R	35	4	13	61
E154.413.R	G154.413.R	41,3	6,4	19	67
E154.570.R	G154.570.R	57	9,5	25	75



Z050.002.N



Z053.002.N



Z054.002.N



Z051.002.R

HW MOULDING BITS WITH BALL BEARING GUIDE Z=2

ART. E156 - G156

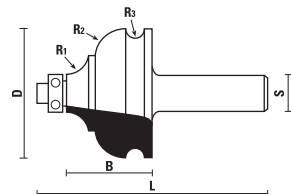

S Ø 12	S Ø 12,7 (1/2")	D	R1	R2	R3	B	L
E156.413.R	G156.413.R	41,3	6,4	9,5	3,2	28,5	75,5



Z050.003.N



Z053.003.N



Z054.002.N



Z051.002.R

HW MOULDING BITS WITH BALL BEARING GUIDE Z=2

ART. E157 - G157

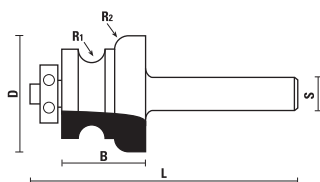

S Ø 12	S Ø 12,7 (1/2")	D	R1	R2	B	L
E157.400.R	G157.400.R	40	5,5	6	30	78



Z050.004.N



Z053.004.N



Z054.002.N



Z051.002.R

HW MOULDING BITS WITH BALL BEARING GUIDE Z=2

ART. E158 - G158

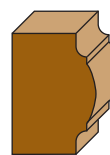
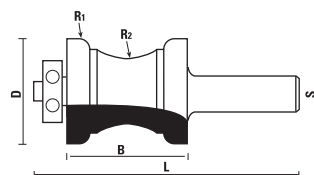

S Ø 12	S Ø 12,7 (1/2")	D	R1	R2	B	L
E158.350.R	G158.350.R	35	5	13	40	88



Z050.004.N



Z053.004.N



Z054.002.N



Z051.002.R

HW DRAWING LINE BITS WITH BALL BEARING GUIDE Z=2

ART. E159 - G159

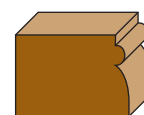
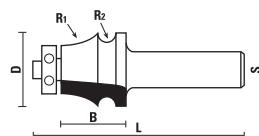

S Ø 12	S Ø 12,7 (1/2")	D	R1	R2	B	L
E159.254.R	G159.254.R	25,4	19	3,2	22	70



Z050.004.N



Z053.004.N



Z054.002.N



Z051.002.R

HW DRAWING LINE BITS WITH BALL BEARING GUIDE Z=2

ART. E160 - G160

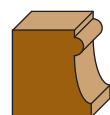
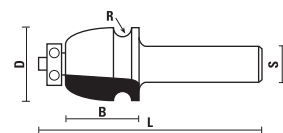

S Ø 12	S Ø 12,7 (1/2")	D	R	B	L
E160.260.R	G160.260.R	26	3,5	25	74



Z050.003.N



Z053.003.N



Z054.002.N



Z051.002.R

HW DRAWING LINE BITS WITH BALL BEARING GUIDE Z=2

ART. E161 - G161

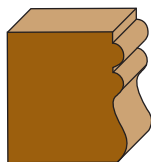
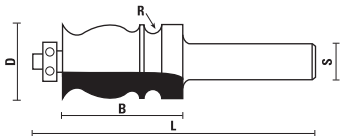

S Ø 12	S Ø 12,7 (1/2")	D	R	B	L
E161.254.R	G161.254.R	25,4	3,5	45	94
Z050.003.N	Z053.003.N	Z054.002.N	Z051.002.R		

HW ARCHITECTURAL MOULDING LINE BITS WITH BALL BEARING GUIDE Z=2

ART. E162 - G162

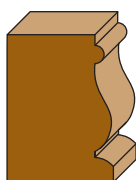
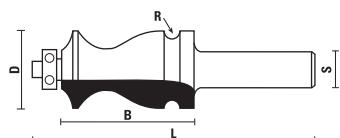

S Ø 12	S Ø 12,7 (1/2")	D	R	B	L
E162.270.R	G162.270.R	27	3	45	94
Z050.003.N	Z053.003.N	Z054.002.N	Z051.002.R		

HW ARCHITECTURAL MOULDING LINE BITS WITH BALL BEARING GUIDE Z=2

ART. E163 - G163

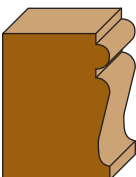
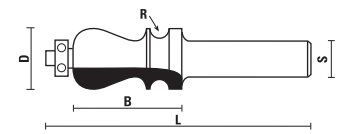

S Ø 12	S Ø 12,7 (1/2")	D	R	B	L
E163.220.R	G163.220.R	22	4	38	87
Z050.003.N	Z053.003.N	Z054.002.N	Z051.002.R		

HW ARCHITECTURAL MOULDING LINE BITS WITH BALL BEARING GUIDE Z=2

ART. E164 - G164

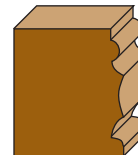
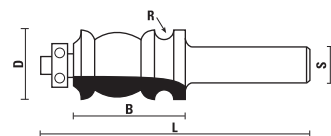

S Ø 12	S Ø 12,7 (1/2")	D	R	B	L
E164.240.R	G164.240.R	24	3,5	39	89
Z050.003.N	Z053.003.N	Z054.002.N	Z051.002.R		

HW MULTI RADIUS BITS Z=2

ART. E165 - G165

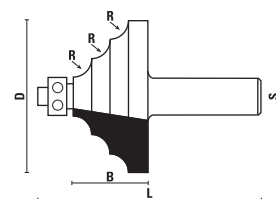

S Ø 12	S Ø 12,7 (1/2")	D	R	B	L
E165.470.R	G165.470.R	47	6	24	73
Z050.003.N	Z053.003.N	Z054.002.N	Z051.002.R		

HW MULTIPLE PROFILE BITS Z=2

ART. E166 - G166

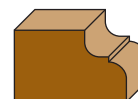
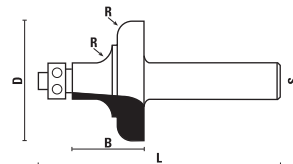

S Ø 12	S Ø 12,7 (1/2")	D	R	B	L
E166.510.R	G166.510.R	51	8,5	31	80
Z050.003.N	Z053.003.N	Z054.002.N	Z051.002.R		

HW MULTIPLE PROFILE BITS Z=2

ART. E167 - G167

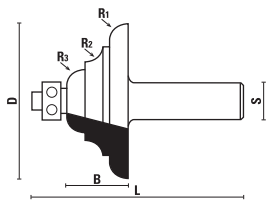

S Ø 12	S Ø 12,7 (1/2")	D	R1	R2	R3	B	L
E167.590.R	G167.590.R	59	6,5	6,5	7,5	22	70



Z050.003.N



Z053.003.N



Z054.002.N



Z051.002.R

HW MULTIPLE PROFILE BITS Z=2

ART. E168 - G168

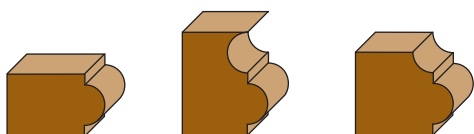
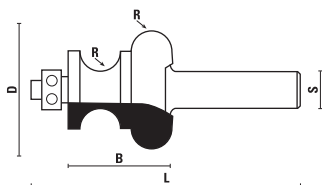

S Ø 12	S Ø 12,7 (1/2")	D	R	B	L
E168.510.R	G168.510.R	51	6,4	32	80



Z050.004.N



Z053.004.N



Z054.002.N



Z051.002.R

HW CLASSICAL MULTI-FORM BITS WITH BALL BEARING GUIDE Z=2

ART. E169 - G169

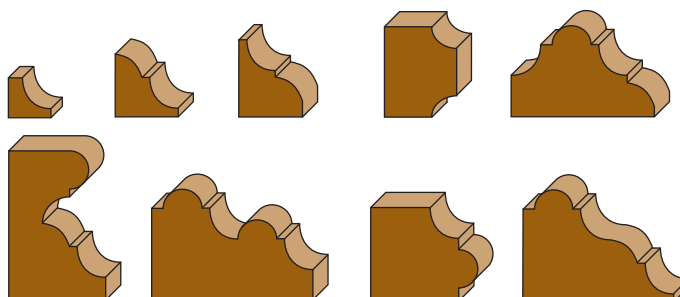
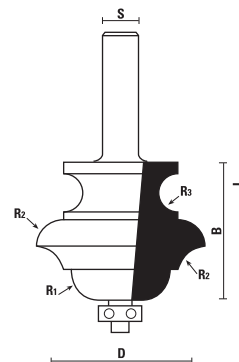

S Ø 12	S Ø 12,7 (1/2")	D	R1	R2	R3	B	L
E169.540.R	G169.540.R max RPM 18.000	54	9	8,5	6,4	47	96



Z050.003.N



Z053.003.N



Z054.002.N



Z051.002.R

HW HANDRAIL BITS WITH BALL BEARING GUIDE Z=2

ART. E170 - G170

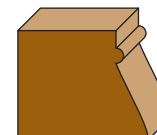
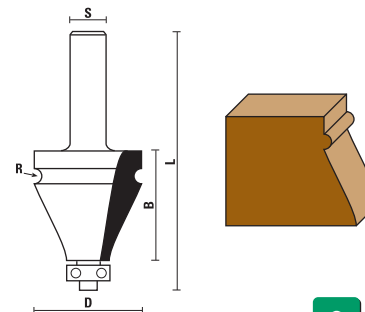

S Ø 12	S Ø 12,7 (1/2")	D	R	B	L
E170.350.R	G170.350.R	35	3,2	37	86



Z050.003.N



Z053.003.N



Z054.002.N



Z051.002.R

SAMPLE OF HANDRAIL PATTERNS

E170

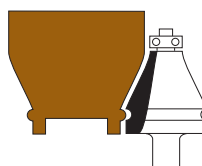

E171

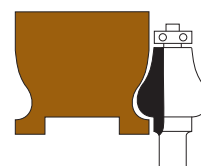

E176

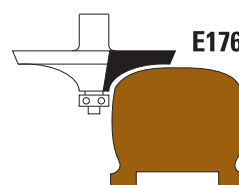

E177

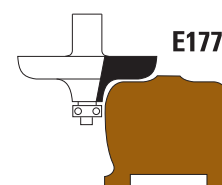

HW HANDRAIL BITS WITH BALL BEARING GUIDE Z=2

ART. E171 - G171

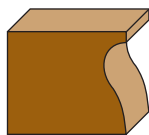
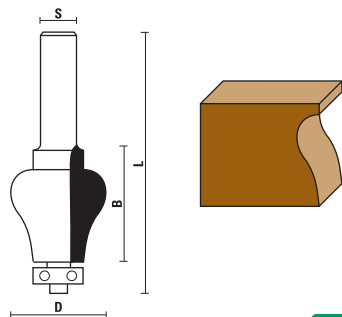

S Ø 12	S Ø 12,7 (1/2")	D	R	B
--------	-----------------	---	---	---

E171.320.R	G171.320.R	32	38	87
------------	------------	----	----	----



Z050.003.N



Z053.003.N



Z054.002.N



Z051.002.R

HW EDGE BEADING BITS Z=2

ART. E172 - G172

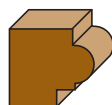
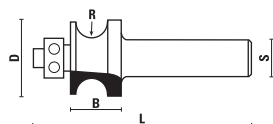

S Ø 12	S Ø 12,7 (1/2")	D	R	B	L
--------	-----------------	---	---	---	---

E172.220.R	G172.220.R	22	3,2	14	63
E172.280.R	G172.280.R	28	4,8	16	66
E172.320.R	G172.320.R	32	6,4	19	67
E172.380.R	G172.380.R	38	9,5	25	74



Z050.004.N



Z053.004.N



Z054.002.N



Z051.002.R

HW HANDRAIL AND TABLE EDGE BITS Z=2

ART. E173 - G173

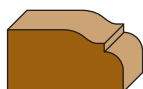
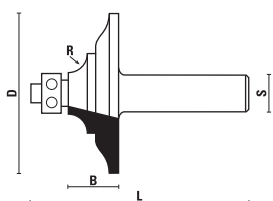

S Ø 12	S Ø 12,7 (1/2")	D	R	B	L
--------	-----------------	---	---	---	---

E173.640.R	G173.640.R - max RPM 18.000	64	6,5	20	69
------------	-----------------------------	----	-----	----	----



Z050.003.N



Z053.003.N



Z054.002.N



Z051.002.R

HW HANDRAIL AND TABLE EDGE BITS Z=2

ART. E174 - E174

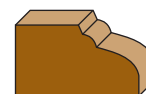
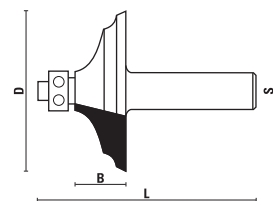

S Ø 12	S Ø 6,4 (1/4")	D	B	L
--------	----------------	---	---	---

E174.660.R	G174.660.R - max RPM 18.000	66	20	69
------------	-----------------------------	----	----	----



Z050.003.N



Z053.003.N



Z054.002.N



Z051.002.R

HW RAISED PANEL BITS WITH BALL BEARING GUIDE Z=2

ART. E175 - E175

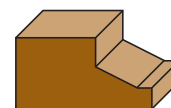
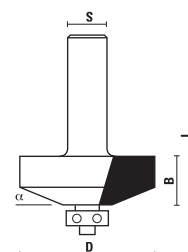

S Ø 12	S Ø 12,7 (1/2")	D	α	B	L
--------	-----------------	---	---	---	---

E175.420.R	G175.420.R	42	25°	13	62
------------	------------	----	-----	----	----



Z050.003.N



Z053.003.N



Z054.002.N



Z051.002.R

HW HANDRAIL-TABLE EDGE BITS WITH BALL BEARING GUIDE Z=2

ART. E176 - G176

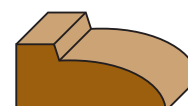
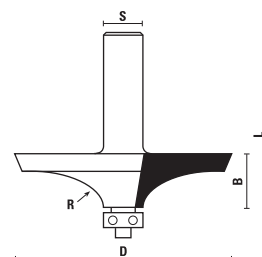

S Ø 12	S Ø 6,4 (1/4")	D	R	B	L
--------	----------------	---	---	---	---

E176.690.R	G176.690.R - max RPM 18.000	69	43	16	64
------------	-----------------------------	----	----	----	----



Z050.003.N



Z053.003.N



Z054.002.N



Z051.002.R

HW HANDRAIL-TABLE EDGE BITS WITH BALL BEARING GUIDE Z=2

ART. E177 - G177

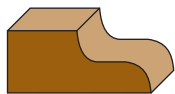
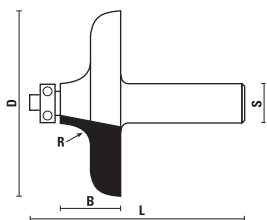

S Ø 12	S Ø 12,7 (1/2")	D	R	B	L
E177.640.R	G177.640.R - max RPM 18.000	64	9,5	20	69
Z050.003.N	Z053.003.N	Z054.002.N	Z051.002.R		

HW RAISED PANEL BITS WITH BALL BEARING GUIDE Z=2

ART. E178 - G178

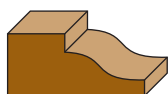
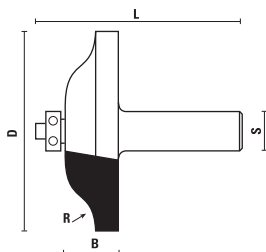

S Ø 12	S Ø 12,7 (1/2")	D	R	B	L
E178.670.R	G178.670.R - max RPM 18.000	67	19	17	65
E178.860.R	G178.860.R - max RPM 16.000	86	22	16	65
Z050.003.N	Z053.003.N	Z054.002.N	Z051.002.R		

HW RAISED PANEL BITS WITH BALL BEARING GUIDE Z=2

ART. E178 - G178

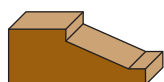
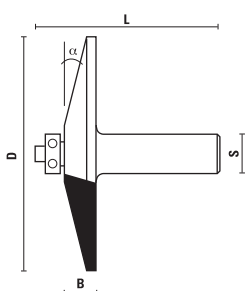

S Ø 12	S Ø 12,7 (1/2")	D	α	B	L
E178.861.R	G178.861.R - max RPM 16.000	86	15°	13	61
Z050.003.N	Z053.003.N	Z054.002.N	Z051.002.R		

HW RAISED PANEL BITS WITH BALL BEARING GUIDE Z=2

ART. E178 - G178

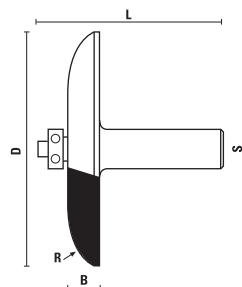

S Ø 12	S Ø 12,7 (1/2")	D	R	B	L
E178.862.R	G178.862.R - max RPM 16.000	86	40	13	61
Z050.003.N	Z053.003.N	Z054.002.N	Z051.002.R		

HW RAISED PANEL BITS WITH BALL BEARING GUIDE Z=2

ART. E179 - G179

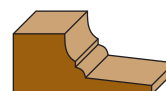
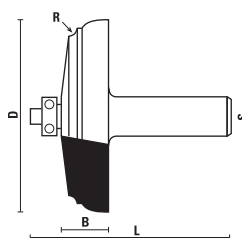

S Ø 12	S Ø 12,7 (1/2")	D	R	B	L
E179.640.R	G179.640.R - max RPM 18.000	64	3	13	62
Z050.003.N	Z053.003.N	Z054.002.N	Z051.002.R		

HW FINGER JOINT ASSEMBLY WITH BALL BEARING GUIDE Z=2

ART. E180 - G180

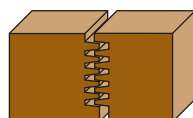
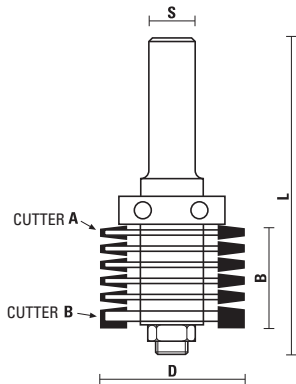

Working height 11 to 36 mm



S Ø 12	S Ø 12,7 (1/2")	D	B	L	Z
E180.397.R	G180.397.R	39,7	36	96	2

SPARE PARTS

Arbor

S Ø 12	S Ø 12,7 (1/2")
E117.120.R	G117.120.R

Finger cutter "A" (5 pcs.) Ø 39,2/Ø 8 Z=2 Sp.=1,85
C180.500.R

Straight cutter "B" (1 pcs.) Ø 39,7/Ø 8 Z=2 Sp.=5,5
C180.501.R



Z050.010.N



Z057.001.N - 6 pcs.



Z057.002.N - 2 pcs.
Z057.003.N - 1 pcs.
Z057.004.N - 10 pcs.

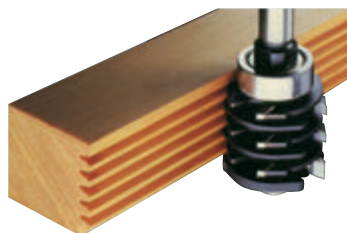
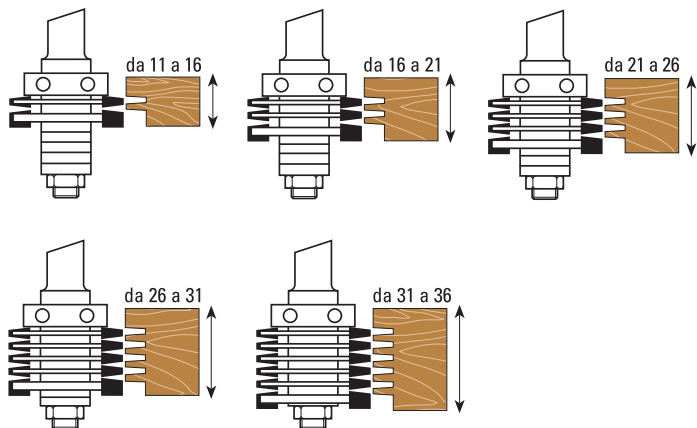

HW FINGER JOINT ASSEMBLY WITH BALL BEARING GUIDE Z=3

ART. E181 - G181

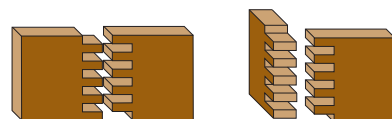
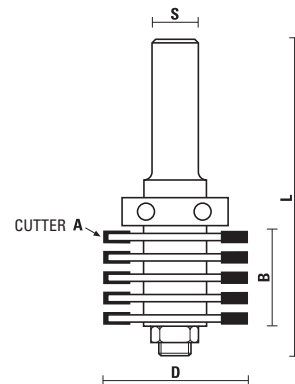

- Working height 22 to 45 mm
- Supplied with nr. 3 ball bearings for producing nr. 3 different cutting depths (E=9,8 - E=9,3 - E=6,8)



S Ø 12	S Ø 12,7 (1/2")	D	B	L	Z	E
E181.476.R	G181.476.R	47,6	36	96	3	9,8

SPARE PARTS

Arbor

S Ø 12	S Ø 12,7 (1/2")
E117.120.R	G117.120.R

Finger cutter "A" (5 pcs.) Ø 47,6/Ø 8 Z=3 Sp.=4
C118.340.R



Z050.107.N - 1 pcs.
Z050.108.N - 1 pcs.
Z050.109.N - 1 pcs.



Z057.009.N - 4 pcs.



Z057.004.N - 4 pcs.
Z057.008.N - 8 pcs.

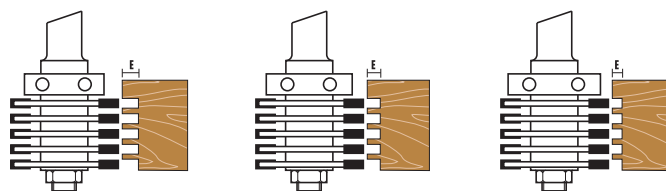

Z050.107.N
Ball bearing Ø28
E=9,8

Z050.108.N
Ball bearing Ø29
E=9,3

Z050.109.N
Ball bearing Ø34
E=6,8

HW SLOT CUTTER SET WITH BALL BEARING GUIDE Z=2

ART. E182 - G182

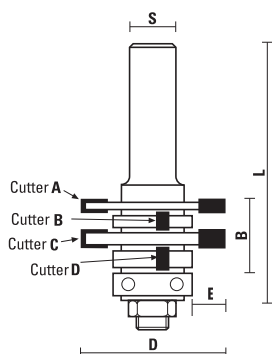

- For groovings 3,2 mm up to 18 mm
- Some possible combinations to obtain different measures of grooves
- Adding or removing the spacers included in the kit, can be obtained more measures (see drawing)



S Ø 12	S Ø 12,7 (1/2")	D	B	L	Z	E
E182.476.R	G182.476.R	47,6	3,2÷18	76	2	12,8

SPARE PARTS

Arbor

S Ø 12	S Ø 12,7 (1/2")
E117.123.R	G117.123.R

Cutter (4 pcs.)

"A" - C118.232.R	Ø 47,6/Ø 8	Z=2	Sp.=3,2
"B" - C118.240.R	Ø 47,6/Ø 8	Z=2	Sp.=4
"C" - C118.248.R	Ø 47,6/Ø 8	Z=2	Sp.=4,8
"D" - C118.264.R	Ø 47,6/Ø 8	Z=2	Sp.=6,4



Z050.008.N - 1 pcs.



Z057.006.N - 3 pcs.
Z057.002.N - 5 pcs.



Z057.003.N - 5 pcs.
Z057.004.N - 10 pcs.

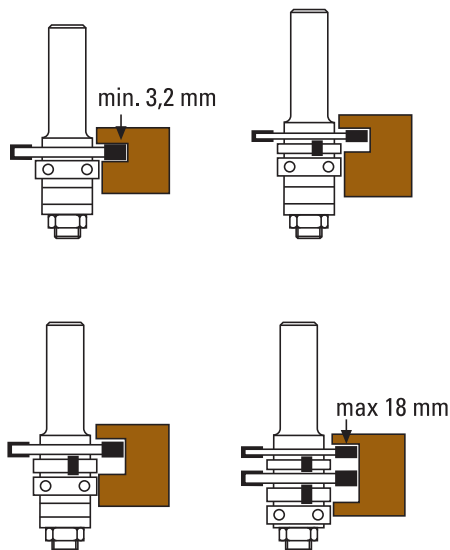

HW DOUBLE CORNER ROUND ASSEMBLY WITH BALL BEARING GUIDE Z=3

ART. E186 - G186 - C186

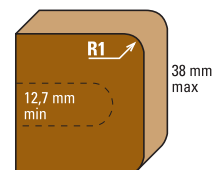
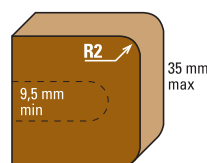
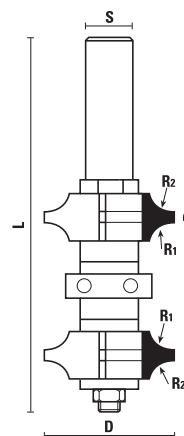

- R2 = 4,8 mm
- Working height 9,5 to 35 mm
- R1 = 6,4 mm
- Working height 12,7 to 38 mm



S Ø 12	S Ø 12,7 (1/2")	S Ø 8	D	R1	R2	B	L
E186.350.R	G186.350.R	C186.350.R	35	6,4	4,8	14	108

SPARE PARTS

Arbor

S Ø 12	S Ø 12,7 (1/2")	S Ø 8
E117.121.R	G117.121.R	C117.081.R

Top cutter	Ø 35/Ø 8	Z=3	R1=6,4	R2=4,8
C186.500.R				

Bottom cutter	Ø 35/Ø 8	Z=3	R1=6,4	R2=4,8
C186.501.R				



Z050.008.N - 1 pcs.



Z057.002.N - 2 pcs.
Z057.005.N - 2 pcs.
Z057.006.N - 2 pcs.



Z057.003.N - 1 pcs.
Z057.004.N - 4 pcs.

HW DOUBLE CHAMFER ASSEMBLY WITH BALL BEARING GUIDE Z=3

ART. E187 - G187 - C187

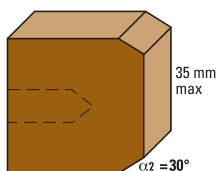
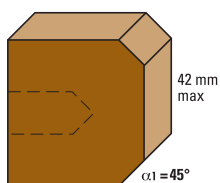
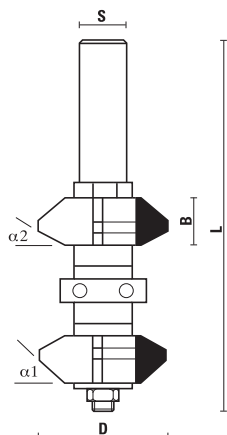

- $\alpha 1 = 45^\circ$ (Working height 0 to 42 mm)
- $\alpha 2 = 30^\circ$ (Working height 0 to 35 mm)



S Ø 12	S Ø 12,7 (1/2")	S Ø 8	D	B	$\alpha 1$	$\alpha 2$	L
E187.350.R	G187.350.R	C187.350.R	35	14	45°	30°	108

SPARE PARTS

Arbor

S Ø 12	S Ø 12,7 (1/2")	S Ø 8
E117.121.R	G117.121.R	C117.081.R

Top cutter	Ø 35/Ø 8	Z=3	$\alpha 1=45^\circ$	$\alpha 2=30^\circ$
C187.500.R				

Bottom cutter	Ø 35/Ø 8	Z=3	$\alpha 1=45^\circ$	$\alpha 2=30^\circ$
C187.501.R				



Z050.008.N - 1 pcs.



Z057.002.N - 3 pcs.
Z057.005.N - 2 pcs.
Z057.006.N - 2 pcs.



Z057.003.N - 1 pcs.
Z057.004.N - 4 pcs.

HW BEAD PANELING ASSEMBLY WITH BALL BEARING GUIDE Z=2

ART. E188 - G188 - C188

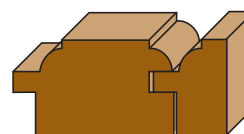
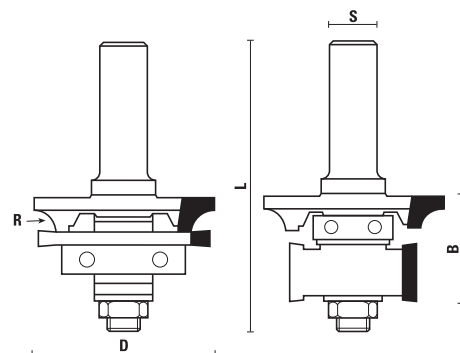

S Ø 12	S Ø 12,7 (1/2")	S Ø 8	D	R	B	L
E188.490.R	G188.490.R	C188.490.R	49	6	30	80

SPARE PARTS

Arbor

S Ø 12	S Ø 12,7 (1/2")	S Ø 8
E117.122.R	G117.122.R	C117.082.R

Profile cutter	Ø 49/Ø 8	Z=2	Sp.=9
C188.500.R			

Grooving cutter	Ø 46/Ø 8	Z=2	Sp.=4
C188.501.R			

Rabbeting cutter	Ø 33,5/Ø 8	Z=2	Sp.=17,5
C188.502.R			



Z050.008.N - 1 pcs.
Z050.016.N - 1 pcs.



Z057.002.N - 2 pcs.
Z057.005.N - 3 pcs.



Z057.003.N - 1 pcs.
Z057.007.N - 1 pcs.
Z057.004.N - 3 pcs.
Z057.008.N - 1 pcs.

HW V PANELING ASSEMBLY WITH BALL BEARING GUIDE Z=2

ART. E189 - G189 - C189

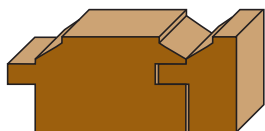
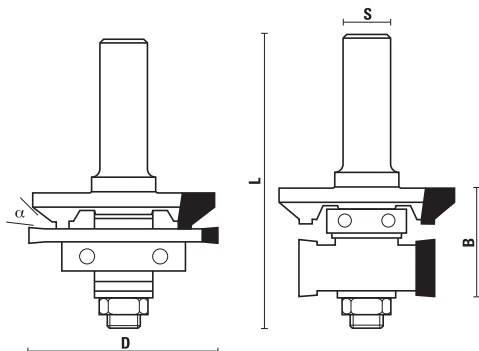

S Ø 12	S Ø 12,7 (1/2")	S Ø 8	D	α	B	L
E189.425.R	G189.425.R	C189.425.R	42,5	45°	30	80

SPARE PARTS

Arbor

S Ø 12	S Ø 12,7 (1/2")	S Ø 8
E117.122.R	G117.122.R	C117.082.R

Profile cutter 45°	Ø 42,5/Ø 8	Z=2	Sp.=9
C189.500.R			

Grooving cutter	Ø 46/Ø 8	Z=2	Sp.=4
C188.501.R			

Rabbeting cutter	Ø 33,5/Ø 8	Z=2	Sp.=17,5
C188.502.R			



Z050.008.N - 1 pcs.
Z050.016.N - 1 pcs.



Z057.002.N - 2 pcs.
Z057.005.N - 3 pcs.



Z057.003.N - 1 pcs.
Z057.007.N - 1 pcs.
Z057.004.N - 3 pcs.
Z057.008.N - 1 pcs.

HW OGEE WINDOW SASH ASSEMBLY WITH BALL BEARING GUIDE Z=2

ART. E191 - G191 - C191

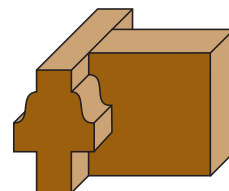
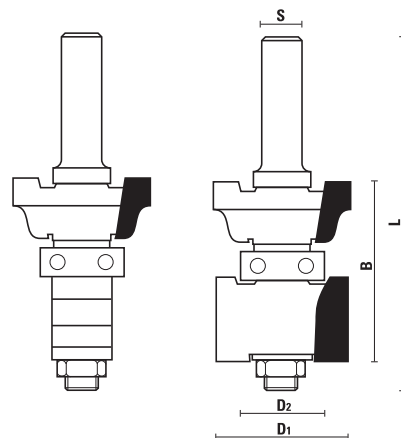

S Ø 12	S Ø 12,7 (1/2")	S Ø 8	D1	D2	B	L
E191.350.R	G191.350.R	C191.350.R	35	22	47	96

SPARE PARTS

Arbor

S Ø 12	S Ø 12,7 (1/2")	S Ø 8
E117.120.R	G117.120.R	C117.080.R

Profile cutter	Ø 35/Ø 8	Z=2	Sp.=17
C191.500.R			

Rabbeting cutter	Ø 35/Ø 8	Z=2	Sp.=22
C191.501.R			



Z050.008.N - 1 pcs.



Z057.005.N - 1 pcs.
Z057.006.N - 3 pcs.



Z057.003.N - 1 pcs.
Z057.004.N - 3 pcs.
Z057.008.N - 1 pcs.

HW TONGUE AND GROOVE ASSEMBLY WITH BALL BEARING GUIDE Z=2

ART. E193 - G193 - C193

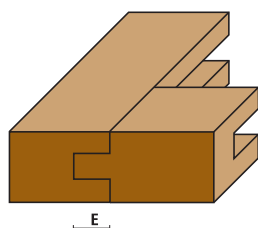
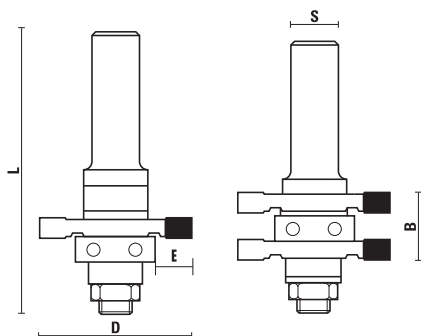

S Ø 12	S Ø 12,7 (1/2")	S Ø 8	D	B	L	E
E193.410.R	G193.410.R		41	19	76	9,5
		C193.410.R	41	19	70	9,5

SPARE PARTS

Arbor

S Ø 12	S Ø 12,7 (1/2")	S Ø 8
E117.123.R	G117.123.R	C117.079.R

Grooving cutter (2 pcs.) Ø 41/Ø 8 Z=2 Sp.=6,4
C193.500.R



Z050.008.N - 1 pcs.



Z057.002.N - 1 pcs.
Z057.006.N - 2 pcs.



Z057.004.N - 4 pcs.
Z057.008.N - 2 pcs.

HW STILE AND RAIL ASSEMBLY WITH BALL BEARING GUIDE Z=2

ART. E194 - G194 - C194

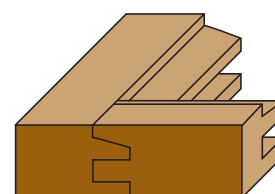
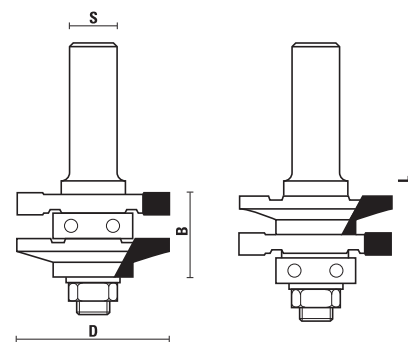

S Ø 12	S Ø 12,7 (1/2")	S Ø 8	D	B	L
E194.410.R	G194.410.R		41	22	76
		C194.410.R	41	22	70

SPARE PARTS

Arbor

S Ø 12	S Ø 12,7 (1/2")	S Ø 8
E117.123.R	G117.123.R	C117.079.R

Profile cutter Ø 41/Ø 8 Z=2 Sp.=11
C194.500.R

Grooving cutter Ø 41/Ø 8 Z=2 Sp.=6,4
C193.500.R



Z050.008.N - 1 pcs.



Z057.004.N - 3 pcs.
Z057.008.N - 1 pcs.

HW STILE AND RAIL ASSEMBLY WITH BALL BEARING GUIDE Z=2

ART. E195 - G195 - C195

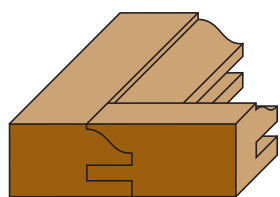
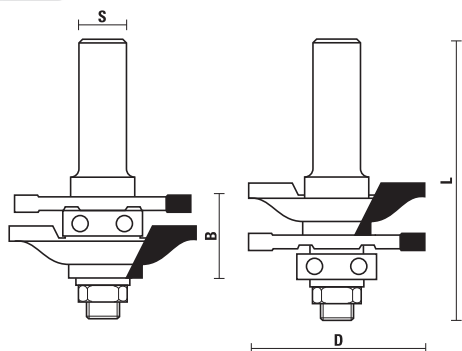

S Ø 12	S Ø 12,7 (1/2")	S Ø 8	D	B	L
E195.460.R	G195.460.R		46	22	76
		C195.460.R	46	22	70

SPARE PARTS

Arbor

S Ø 12	S Ø 12,7 (1/2")	S Ø 8
E117.123.R	G117.123.R	C117.079.R

Profile cutter	Ø 46/Ø 8	Z=2	Sp.=15
C195.500.R			

Grooving cutter	Ø 46/Ø 8	Z=2	Sp.=4
C188.501.R			



Z050.008.N - 1 pcs.



Z057.004.N - 3 pcs.
Z057.008.N - 1 pcs.

HW STILE AND RAIL ASSEMBLY WITH BALL BEARING GUIDE Z=2

ART. E196 - G196 - C196

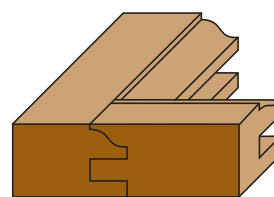
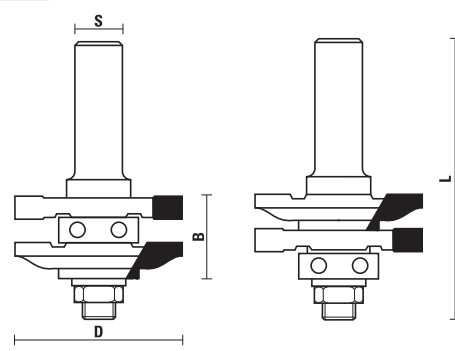

S Ø 12	S Ø 12,7 (1/2")	S Ø 8	D	B	L
E196.410.R	G196.410.R		41	22	76
		C196.410.R	41	22	70

SPARE PARTS

Arbor

S Ø 12	S Ø 12,7 (1/2")	S Ø 8
E117.123.R	G117.123.R	C117.079.R

Profile cutter	Ø 41/Ø 8	Z=2	Sp.=11
C196.500.R			

Grooving cutter	Ø 41/Ø 8	Z=2	Sp.=6,4
C193.500.R			



Z050.008.N - 1 pcs.



Z057.004.N - 2 pcs.
Z057.008.N - 2 pcs.

HW STILE AND RAIL ASSEMBLY WITH BALL BEARING GUIDE Z=2

ART. E197 - G197 - C197

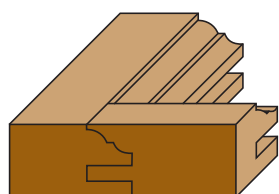
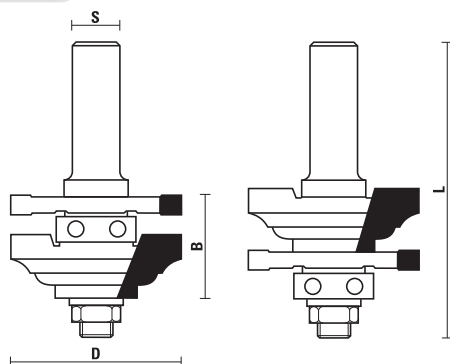

S Ø 12	S Ø 12,7 (1/2")	S Ø 8	D	B	L
E197.460.R	G197.460.R		46	22	76
		C197.460.R	46	22	70

SPARE PARTS

Arbor

S Ø 12	S Ø 12,7 (1/2")	S Ø 8
E117.123.R	G117.123.R	C117.079.R

Profile cutter Ø 46/Ø 8 Z=2 Sp.=15
C197.500.R

Grooving cutter Ø 46/Ø 8 Z=2 Sp.=4
C188.501.R

 Z050.008.N - 1 pcs.

 Z057.004.N - 2 pcs.
Z057.008.N - 2 pcs.

HW STILE AND RAIL ASSEMBLY WITH BALL BEARING GUIDE Z=2

ART. E198 - G198 - C198

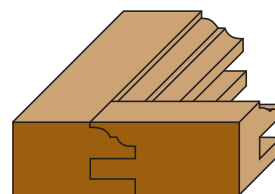
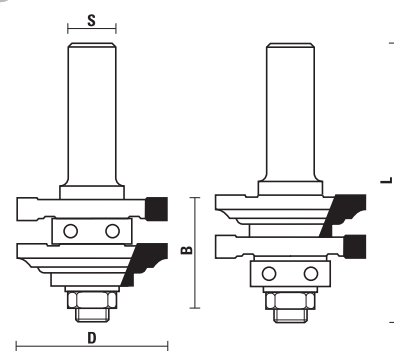

S Ø 12	S Ø 12,7 (1/2")	S Ø 8	D	B	L
E198.410.R	G198.410.R		41	22	76
		C198.410.R	41	22	70

SPARE PARTS

Arbor

S Ø 12	S Ø 12,7 (1/2")	S Ø 8
E117.123.R	G117.123.R	C117.079.R

Profile cutter Ø 41/Ø 8 Z=2 Sp.=11
C198.500.R

Grooving cutter Ø 41/Ø 8 Z=2 Sp.=6,4
C193.500.R

 Z050.008.N - 1 pcs.

 Z057.004.N - 2 pcs.
Z057.008.N - 2 pcs.

HW BEADING BITS FOR RADIUS WINDOW Z=2

ART. E199 - G199 - C199

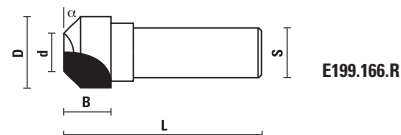
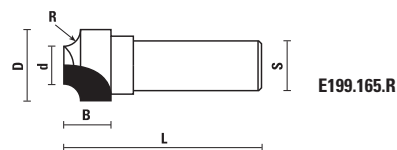
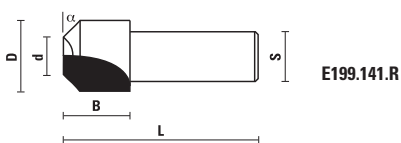
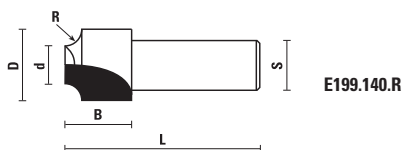
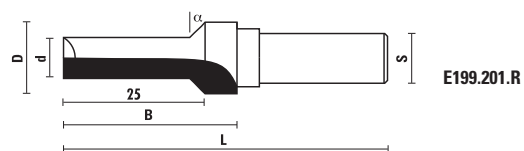
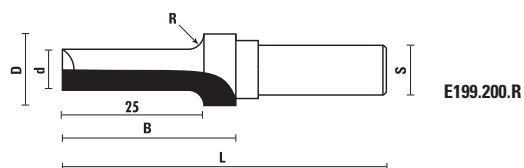
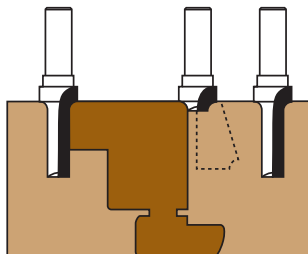

- Use on "ARKADE + ZINKEL" or on similar equipment
 - Bits for glass-fixing lath see item Art. T141.061.R (HM) page 7.38
 and Art. U211.061.R (HSS) page 8.08



S Ø 12	S Ø 12,7 (1/2")	S Ø 8	D	d	R	α	B	L
E199.140.R	G199.140.R	C199.140.R	14	6	3		16	46
E199.141.R	G199.141.R	C199.141.R	14	6		45°	16	46
E199.165.R	G199.165.R	C199.165.R	16,5	8,5	3		11	46
E199.166.R	G199.166.R	C199.166.R	16,5	8,5		45°	11	46
E199.200.R	G199.200.R	C199.200.R	20	12	3		33	68
E199.201.R	G199.201.R	C199.201.R	20	12		45°	33	68

The device for any single and double radius or elliptical frames

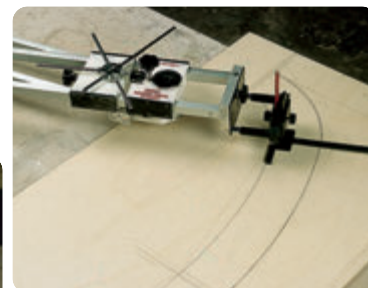
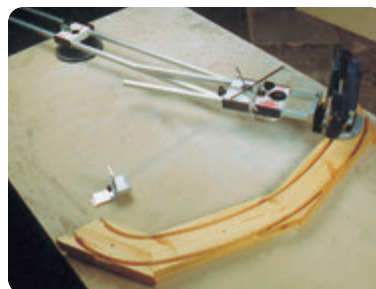

See section 16 page 16.03

2 PIECE SET FOR CABINET DOORS MAKER "TYPE 1"

ART. X021



- Set including stile and rail bit, raised panel bit and service key.
- Practical plastic case.

Item

X021.012.R (S Ø 12) NEW	X021.127.R (Ø 12,7 (1/2")) NEW
2-pcs router bit set:	2-pcs router bit set:
E178.860.R	G178.860.R
E195.460.R	G195.460.R

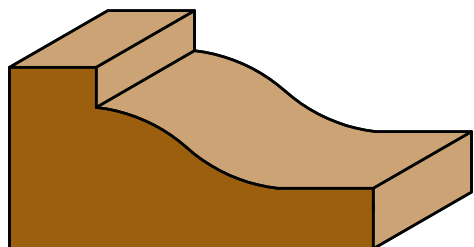

E178.860.R

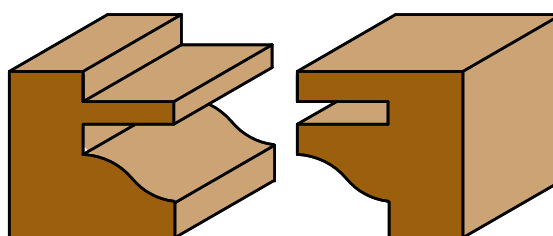

E195.460.R

Scale 1:1

2 PIECE SET FOR CABINET DOORS MAKER "TYPE 2"

ART. X022



- Set including stile and rail bit, raised panel bit and service key.
- Practical plastic case.

Item

X022.012.R (S Ø 12) NEW	X022.127.R (Ø 12,7 (1/2")) NEW
2-pcs router bit set:	2-pcs router bit set:
E178.861.R	G178.861.R
E197.460.R	G197.460.R

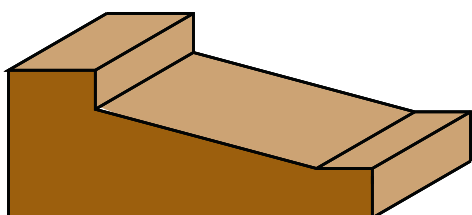

E178.861.R

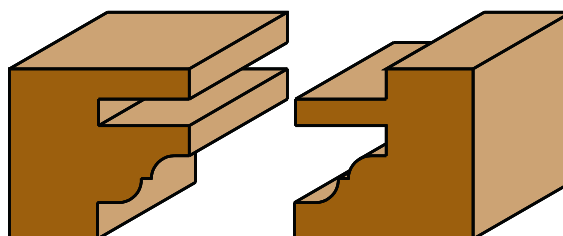

E197.460.R

Scale 1:1

2 PIECE SET FOR CABINET DOORS MAKER "TYPE 3"

ART. X023



- Set including stile and rail bit, raised panel bit and service key.
- Practical plastic case.

Item	
X023.012.R (S Ø 12) NEW	X023.127.R (Ø 12,7 (1/2")) NEW
2-pcs router bit set:	2-pcs router bit set:
E178.862.R	G178.862.R
E193.410.R	G193.410.R

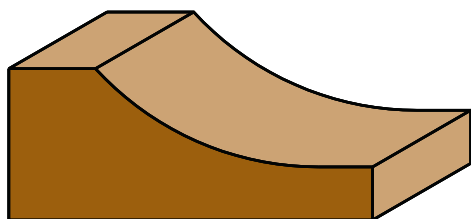

E178.862.R

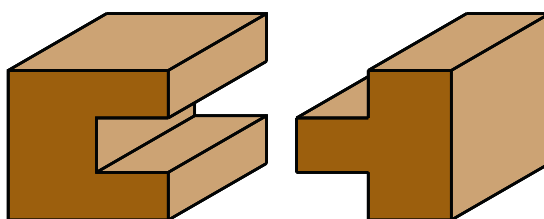

E193.410.R

Scale 1:1

3 PIECE SET FOR CABINET DOORS MAKER AND JOINTS "TYPE 1"

ART. X024



- Set including stile and rail bit, raised panel bit and slot cutter.
- Practical plastic case.

Item	
X024.012.R (S Ø 12) NEW	X024.127.R (Ø 12,7 (1/2")) NEW
3-pcs router bit set:	3-pcs router bit set:
E178.860.R	G178.860.R
E195.460.R	G195.460.R
E182.476.R	G182.476.R

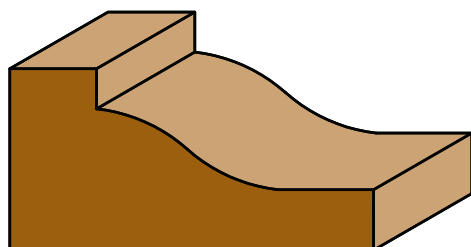

E178.860.R

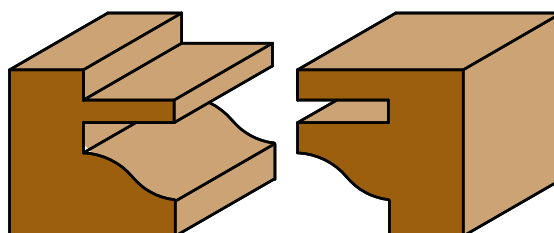

E195.460.R

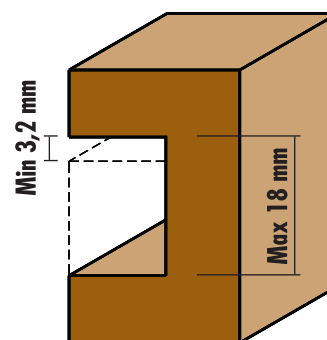

E182.476.R

Scale 1:1

3 PIECE SET FOR CABINET DOORS MAKER AND JOINTS "TYPE 2"

ART. X025



- Set including stile and rail bit, raised panel bit and slot cutter.
- Practical plastic case.

Item

X025.012.R (S Ø 12) NEW	X025.127.R (Ø 12,7 (1/2")) NEW
3-pcs router bit set:	3-pcs router bit set:
E178.861.R	G178.861.R
E197.460.R	G197.460.R
E182.476.R	G182.476.R

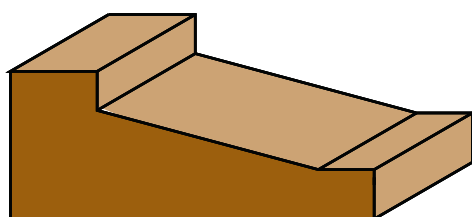

E178.861.R

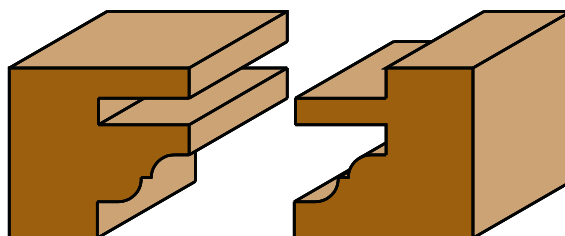

E197.460.R

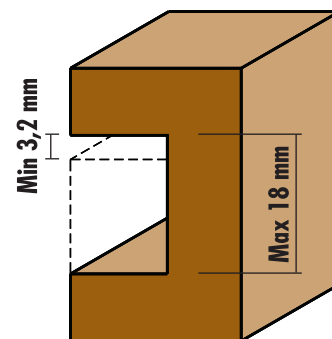

E182.476.R

Scale 1:1

3 PIECE SET FOR CABINET DOORS MAKER AND JOINTS "TYPE 3"

ART. X026



- Set including stile and rail bit, raised panel bit and slot cutter.
- Practical plastic case.

Item

X026.012.R (S Ø 12) NEW	X026.127.R (Ø 12,7 (1/2")) NEW
3-pcs router bit set:	3-pcs router bit set:
E178.862.R	G178.862.R
E193.410.R	G193.410.R
E182.476.R	G182.476.R

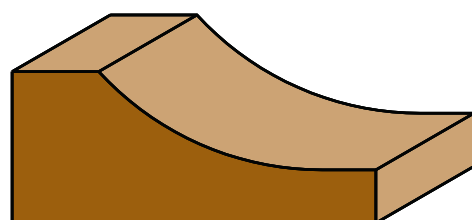

E178.862.R

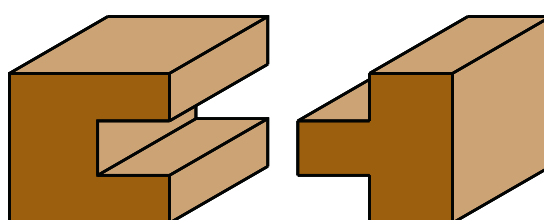

E193.410.R

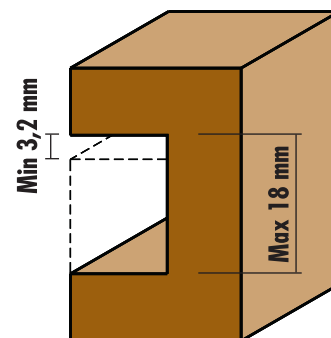

E182.476.R

Scale 1:1

Router bits for wood, chipboards and solid surface materials



3



HW ROUTER BITS WITH NEGATIVE AXIAL ANGLE Z=2
Page 3.05



HW STRAIGHT PLUNGE BITS Z=1
Page 3.05



HW STRAIGHT PLUNGE BITS WITH BALL BEARING GUIDE Z=2
Page 3.05

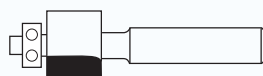

HW FACE-INLAY BITS WITH BALL BEARING GUIDE Z=2
Page 3.05



HW FLUSH TRIM BITS WITH BALL BEARING GUIDE Z=2
Page 3.06



HW FLUSH TRIM BITS WITH UPPER BALL BEARING GUIDE Z=2
Page 3.06



HW TOPMOUNT ROUTER BITS Z=2
Page 3.06



HW BEVEL HOLE ROUTER BITS Z=3
Page 3.06



HW BEVEL UNDERMOUNT BITS WITH BALL BEARING GUIDE Z=2
Page 3.06

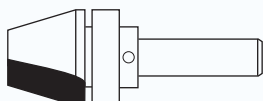

HW TOPMOUNT COUNTERTOP BITS WITH UPPER BALL BEARING GUIDE Z=2
Page 3.06

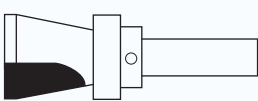

HW TOPMOUNT COUNTERTOP BITS WITH UPPER BALL BEARING GUIDE Z=2
Page 3.07

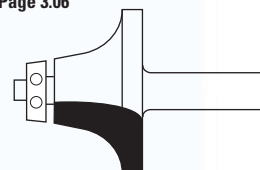

HW ROUNDOVER BITS WITH BALL BEARING GUIDE Z=2
Page 3.07

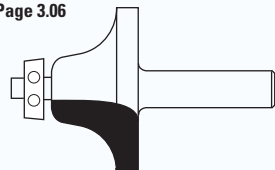

HW OGEE BITS WITH BALL BEARING GUIDE Z=2
Page 3.07



HW COUNTER-TOP BITS WITH BALL BEARING GUIDE Z=2
Page 3.07



HW CORNER TOP BITS Z=2
Page 3.07

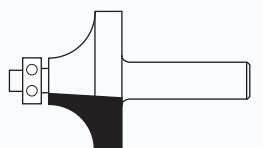

HW CORNER ROUNDING BITS WITH BALL BEARING GUIDE Z=2
Page 3.08

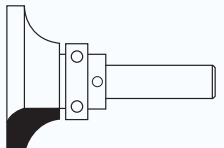

HW ROUNDING-UNDER BITS WITH UPPER BALL BEARING GUIDE Z=2
Page 3.08

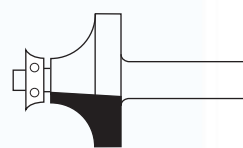

HW CORNER-ROUNDING BITS WITH BALL BEARING GUIDE Z=2
Page 3.08



HW EDGE FACE COVE BITS WITH BALL BEARING GUIDE Z=2
Page 3.08



HW UPSTAND BITS Z=2
Page 3.08

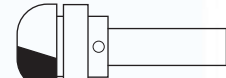

HW COVE BITS WITH UPPER BALL BEARING GUIDE Z=2
Page 3.09



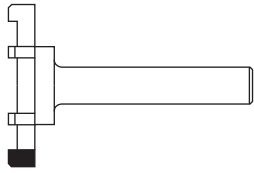

HW BOWL AND COUNTERTOP TRIM BITS Z=2
Page 3.09



HW PROFILE BITS Z=2
Page 3.09

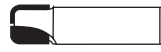

HW PROFILE BITS Z=2
Page 3.09

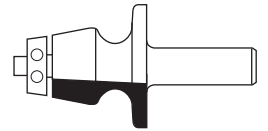

HW UNDERMOUNT PROFILE BOWL BITS WITH BALL BEARING GUIDE Z=2
Page 3.09

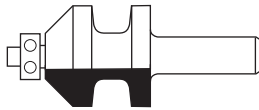

HW BEVEL HOB BITS WITH BALL BEARING GUIDE Z=2
Page 3.09

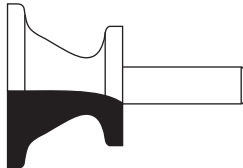

HW BEADING BITS Z=2
Page 3.10



HW TRIPLE BEADING BITS WITH BALL BEARING GUIDE Z=2
Page 3.10

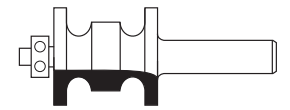

HW DOUBLE BEADING BITS WITH BALL BEARING GUIDE Z=2
Page 3.10

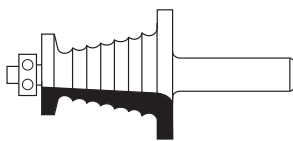

HW MULTI BEADING BITS WITH BALL BEARING GUIDE Z=2
Page 3.10

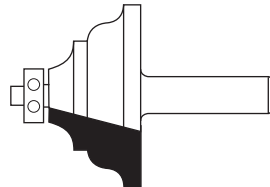

HW EDGE MOULDING BITS WITH BALL BEARING GUIDE Z=2
Page 3.10

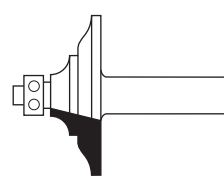

HW EDGE MOULDING BITS WITH BALL BEARING GUIDE Z=2
Page 3.10

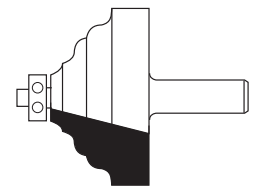

HW EDGE MOULDING BITS WITH BALL BEARING GUIDE Z=2
Page 3.11

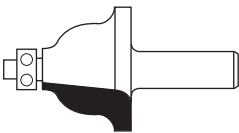

HW WAVY EDGE BITS WITH BALL BEARING GUIDE Z=2
Page 3.11

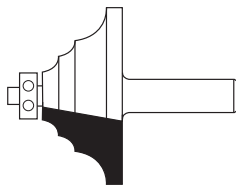

HW EDGE MOULDING BITS WITH BALL BEARING GUIDE Z=2
Page 3.11

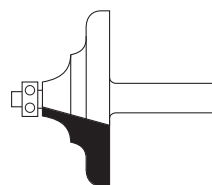

HW EDGE MOULDING BITS WITH BALL BEARING GUIDE Z=2
Page 3.11

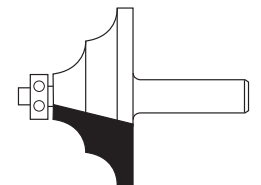

HW EDGE MOULDING BITS WITH BALL BEARING GUIDE Z=2
Page 3.11



HW ROMAN OGEE BITS WITH BALL BEARING GUIDE Z=2
Page 3.11

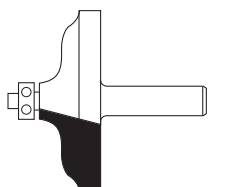

HW EDGE MOULDING BITS WITH BALL BEARING GUIDE Z=2
Page 3.12

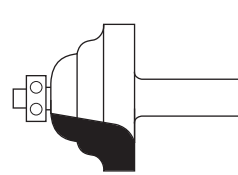

HW EDGE MOULDING BITS WITH BALL BEARING GUIDE Z=2
Page 3.12

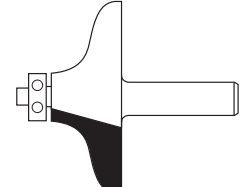

HW EDGE MOULDING BITS WITH BALL BEARING GUIDE Z=2
Page 3.12

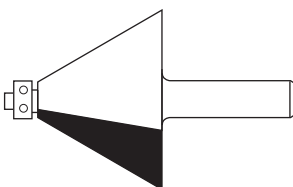

HW BEVEL BITS WITH BALL BEARING GUIDE Z=2
Page 3.12

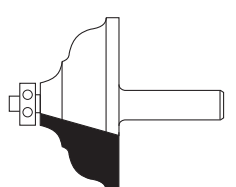

HW EDGE MOULDING BITS WITH BALL BEARING GUIDE Z=2
Page 3.12

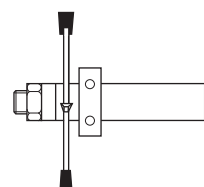

HW ROUTER BITS FOR SINK REPAIRING
Page 3.13

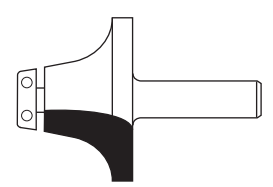

HW ROUNDING OVER UNDERMOUNT BOWL BITS WITH BALL BEARING GUIDE Z=2
Page 3.13



HW ROUNDING OVER UNDERMOUNT BOWL BITS WITH BALL BEARING GUIDE Z=2
Page 3.13



INSERT FLUSH TRIM BITS Z=2
Page 3.13



INSERT FLUSH TRIM BITS Z=2
Page 3.13



HW/HS STRAIGHT PLUNGE CUTTING BITS FOR "ELU" Z=2
Page 3.14



HS STRAIGHT PLUNGE CUTTING BITS
FOR "ELU" Z=2
Page 3.14



HW STRAIGHT PLUNGE CUTTING BITS
FOR "ELU" Z=2
Page 3.14

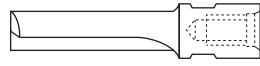

HS STRAIGHT PLUNGE CUTTING BITS FOR
"ELU" Z=2
Page 3.14



HW STRAIGHT PLUNGE CUTTING
BITS FOR "SCHEER" Z=2
Page 3.15



HW STRAIGHT PLUNGE CUTTING BITS
FOR "SCHEER" Z=2
Page 3.15

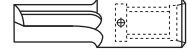

HS STRAIGHT PLUNGE CUTTING BITS
FOR "SCHEER" Z=2
Page 3.15



HS STRAIGHT PLUNGE CUTTING BITS
FOR "SCHEER" Z=2
Page 3.15



HW DRILL BITS FOR "FESTOOL"
MACHINES Z=2
Page 3.15

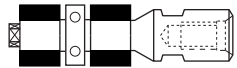

HW FLUSH TRIMMING BITS
WITH BALL BEARING GUIDE Z=2
Page 3.16

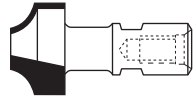

HW RADIUS BITS Z=2
Page 3.16



HW RADIUS BITS WITH
BALL BEARING GUIDE Z=2
Page 3.16



HW RADIUS BITS Z=2
Page 3.16

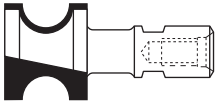

HW RADIUS BITS Z=2
Page 3.16

ROUTER BITS FOR WORKING ON SOLID SURFACE MATERIALS

The series of tools on page 3.05 to page 3.13 have been specifically designed for working Solid Surface materials (**CORIAN®**). The type of raw material, cutting angles and components used in manufacturing the router bits shown here have been carefully selected to get the best finishing. Special router bits can be manufactured on request.



HW ROUTER BITS WITH NEGATIVE AXIAL ANGLE Z=2

ART. E300 - G300

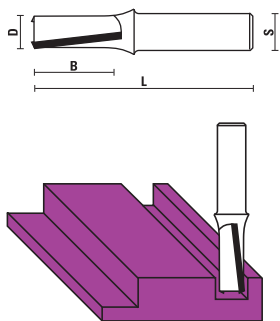

S Ø 12	S Ø 12,7 (1/2")	D	B	L
E300.095.R	G300.095.R	9,5	50	70
E300.127.R	G300.127.R	12,7	32	73
E300.128.R	G300.128.R	12,7	38	79
E300.129.R	G300.129.R	12,7	50	107,5

HW STRAIGHT PLUNGE BITS Z=1

ART. E301 - G301

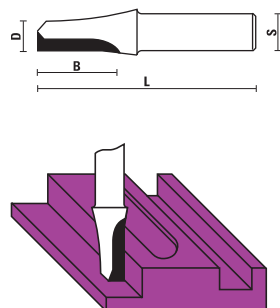

S Ø 12	S Ø 12,7 (1/2")	D	B	L
E301.095.R	G301.095.R	9,5	25	70

HW STRAIGHT PLUNGE BITS WITH BALL BEARING GUIDE Z=2

ART. E302 - G302

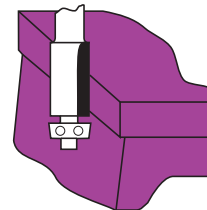
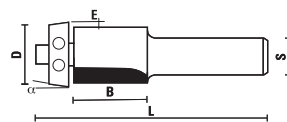

5° ball bearing with Delrin® ring

S Ø 12	S Ø 12,7 (1/2")	D	B	α	E	L
E302.190.R	G302.190.R	19	25	5°	1,6	82,5



S Ø 12	S Ø 12,7 (1/2")	D	B	α	E	L
E302.191.R	G302.191.R	19,6	25	5°	3,2	89



HW FACE-INLAY BITS WITH BALL BEARING GUIDE Z=2

ART. E305 - G305 / E306 - G306 / E307 - G307

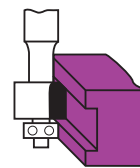
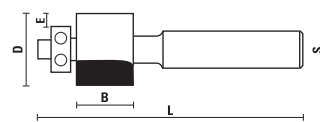

S Ø 12	S Ø 12,7 (1/2")	D	B	L	E
E305.064.R	G305.064.R	22	6,4	76	4,8
E305.095.R	G305.095.R	22	9,5	78	4,8
E305.127.R	G305.127.R	22	12,7	82	4,8
E305.190.R	G305.190.R	22	19	88	4,8



S Ø 12	S Ø 12,7 (1/2")	D	B	L	E
E306.064.R	G306.064.R	22	6,4	76	3,2
E306.095.R	G306.095.R	22	9,5	78	3,2
E306.127.R	G306.127.R	22	12,7	82	3,2
E306.190.R	G306.190.R	22	19	88	3,2



S Ø 12	S Ø 12,7 (1/2")	D	B	L	E
E307.064.R	G307.064.R	22	6,4	78	1,6
E307.095.R	G307.095.R	22	9,5	79	1,6
E307.127.R	G307.127.R	22	12,7	82	1,6
E307.190.R	G307.190.R	22	19	82	1,6



HW FLUSH TRIM BITS WITH BALL BEARING GUIDE Z=2

ART. E310 - G310

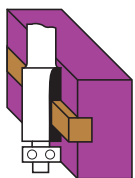
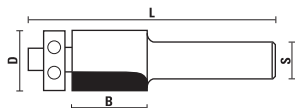

S Ø 12	S Ø 12,7 (1/2")	D	B	L
E310.190.R	G310.190.R	19	25	82



Z050.101.N



Z053.002.N



Z051.004.R

HW FLUSH TRIM BITS WITH UPPER BALL BEARING GUIDE Z=2

ART. E312 - G312

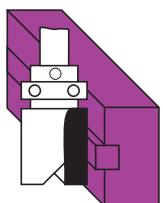
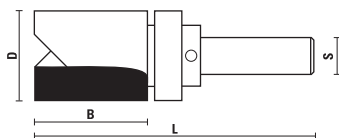

S Ø 12	S Ø 12,7 (1/2")	D	B	L
E312.286.R	G312.286.R	28,6	38	92



Z050.015.N



Z058.003.N



Z051.005.R

HW TOPMOUNT ROUTER BITS Z=2

ART. E315 - G315

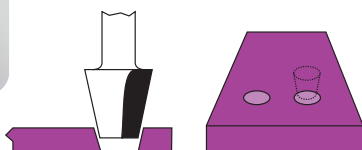
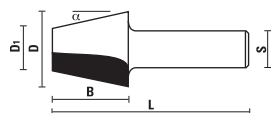

S Ø 12	S Ø 12,7 (1/2")	D	D ₁	B	L	α
E315.240.R	G315.240.R	23	12,3	25	63,1	15°
E315.340.R	G315.340.R	34	23,3	25	63,1	15°
E315.450.R	G315.450.R	45	34,3	25	63,1	15°

HW BEVEL HOLE ROUTER BITS Z=3

ART. E315 - G315

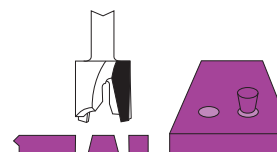
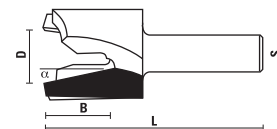

S Ø 12	S Ø 12,7 (1/2")	D	B	L	α
E315.730.R	G315.730.R	23	20	72	15°
E315.840.R	G315.840.R	34	20	72	15°
E315.950.R	G315.950.R	45	20	72	15°

HW BEVEL UNDERMOUNT BITS WITH BALL BEARING GUIDE Z=2

ART. E316 - G316

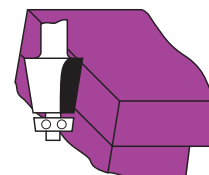
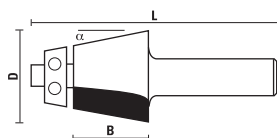

12° ball bearing with Delrin® ring

S Ø 12	S Ø 12,7 (1/2")	D	B	L	α
E316.320.R	G316.320.R	32	25	81	12°



Z050.102.N



Z053.002.N



Z051.004.R

S Ø 12	S Ø 12,7 (1/2")	D	B	L	α
E316.390.R	G316.390.R	39	32	78	12°



Z050.106.N



Z053.002.N



Z051.007.R

HW TOPMOUNT COUNTERTOP BITS WITH UPPER BALL BEARING GUIDE Z=2

ART. E317 - G317

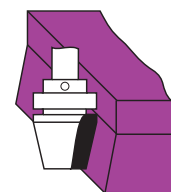
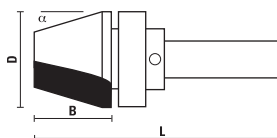

S Ø 12	S Ø 12,7 (1/2")	D	B	L	α
E317.286.R	G317.286.R	28,6	25	78	12°



Z050.015.N



Z058.003.N



Z051.005.R

HW TOPMOUNT COUNTERTOP BITS WITH UPPER BALL BEARING GUIDE Z=2

ART. E321 - G321

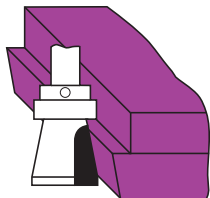
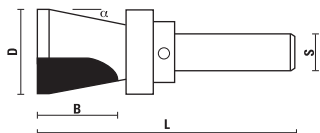

S Ø 12	S Ø 12,7 (1/2")	D	B	L	α
E321.286.R	G321.286.R	28,6	26	79	12°



Z050.015.N



Z058.003.N



Z051.005.R

HW ROUNDROVER BITS WITH BALL BEARING GUIDE Z=2

ART. E325 - G325

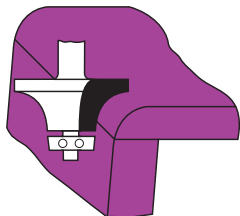
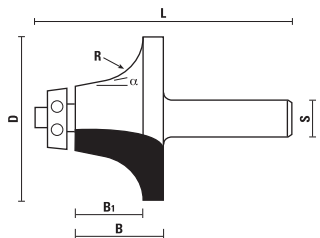

18° ball bearing with Delrin® ring

S Ø 12	S Ø 12,7 (1/2")	D	B	B1	L	R	α
E325.540.R	G325.540.R	54	25	19	79	12,7	18°
E325.570.R	G325.570.R	57	32	25	83	14	18°



Z050.102.N



Z053.002.N



Z051.004.R

HW OGEE BITS WITH BALL BEARING GUIDE Z=2

ART. E326 - G326

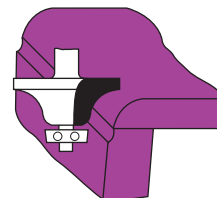
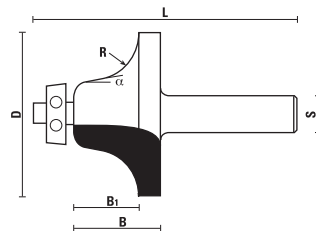

15° ball bearing with Delrin® ring

S Ø 12	S Ø 12,7 (1/2")	D	B	B1	L	R	α
E326.550.R	G326.550.R	55	25	19	75	12,7	15°
E326.610.R	G326.610.R	61	32	25	86	14	15°



Z050.102.N



Z053.002.N



Z051.004.R

HW COUNTER-TOP BITS WITH BALL BEARING GUIDE Z=2

ART. E330 - G330

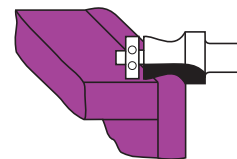
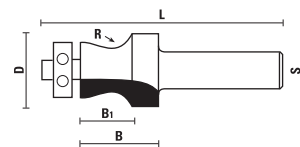

For anti-drip profile on washbasin

S Ø 12	S Ø 12,7 (1/2")	D	B	B1	L	R
E330.220.R	G330.220.R	25	22	16	79	8
E330.290.R	G330.290.R	25	29	24	85	8



Z050.101.N



Z053.002.N



Z051.004.R

HW CORNER TOP BITS Z=2

ART. E333 - G333

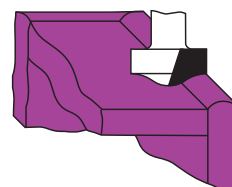
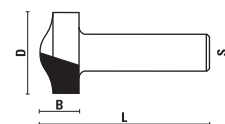

S Ø 12	S Ø 12,7 (1/2")	D	B	L
E333.254.R	G333.254.R	25,4	13	54

HW CORNER ROUNDING BITS WITH BALL BEARING GUIDE Z=2

ART. E334 - G334

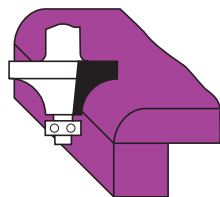
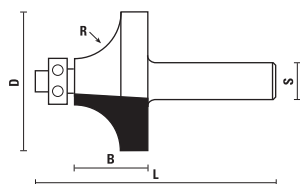
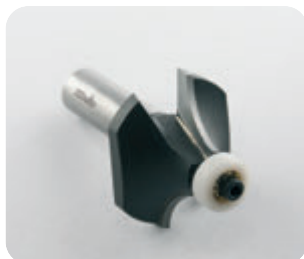

S Ø 12	S Ø 12,7 (1/2")	D	B	L	R
E334.254.R	G334.254.R	25,4	13	62	6,4
E334.286.R	G334.286.R	28,6	13,5	61	8
E334.380.R	G334.380.R	38	19	65	12,7
E334.510.R	G334.510.R	51	25	72	19



Z050.100.N



Z053.002.N



Z051.002.R

HW ROUNDING-UNDER BITS WITH UPPER BALL BEARING GUIDE Z=2

ART. E335 - G335

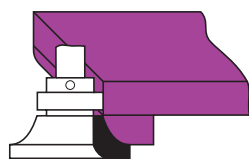
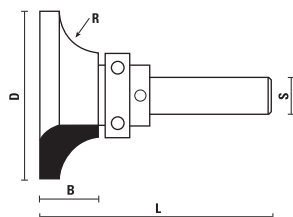

For bottom rounding

S Ø 12	S Ø 12,7 (1/2")	D	B	L	R
E335.540.R	G335.540.R	54	20	73	12,7
E335.670.R	G335.670.R	67	25	77	19



Z050.104.N



Z058.003.N



Z051.005.R

HW CORNER-ROUNDING BITS WITH BALL BEARING GUIDE Z=2

ART. E336 - G336

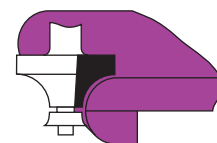
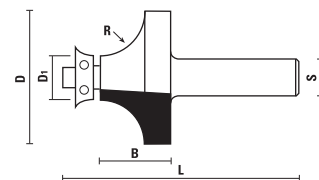
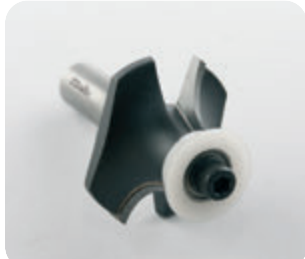

R=12,7 ball bearing

S Ø 12	S Ø 12,7 (1/2")	D	D1	R	B	L
E336.410.R	G336.410.R	41	16	13	19	68



Z050.105.N



Z053.002.N



Z051.004.R

S Ø 12	S Ø 12,7 (1/2")	D	D1	R	B	L
E336.540.R	G336.540.R	54	16	19	25	74



Z050.113.N



Z053.002.N



Z051.004.R

HW EDGE FACE COVE BITS WITH BALL BEARING GUIDE Z=2

ART. E338 - G338

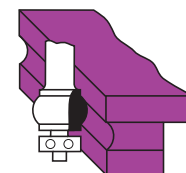
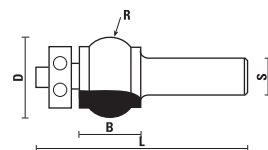

S Ø 12	S Ø 12,7 (1/2")	D	B	L	R
E338.255.R	G338.255.R	25,5	16	67	7,9



Z050.101.N



Z053.002.N



Z051.004.R

HW UPSTAND BITS Z=2

ART. E340 - G340

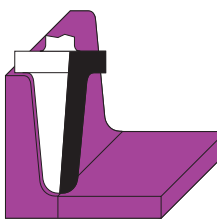
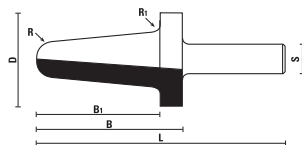

S Ø 12	S Ø 12,7 (1/2")	D	B	B1	R	R1	L
E340.390.R	G340.390.R	39	40	30	6	3	78
E340.391.R	G340.391.R	39	55	45	6	3	93

HW COVE BITS WITH UPPER BALL BEARING GUIDE Z=2

ART. E342 - G342

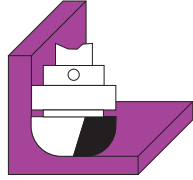
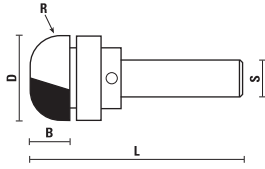

S Ø 12	S Ø 12,7 (1/2")	D	B	R	L
E342.286.R	G342.286.R	28,6	13	10	73



Z050.104.N



Z058.003.N



Z051.005.R

HW BOWL AND COUNTERTOP TRIM BITS Z=2

ART. E350 - G350

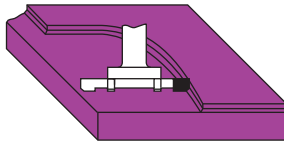
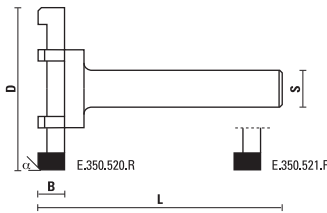

S Ø 12	S Ø 12,7 (1/2")	D	B	L	Z	α
E350.520.R	G350.520.R	52	6,5	83	6	0,5x45°
E350.521.R	G350.521.R	52	6,5	83	6	0°

HW PROFILE BITS Z=2

ART. E360 - G360

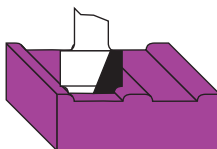
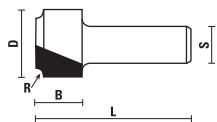

S Ø 12	S Ø 12,7 (1/2")	D	B	R	L
E360.246.R	G360.246.R	24,6	16	2	60

HW PROFILE BITS Z=2

ART. E361 - G361

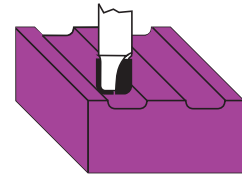
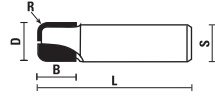

S Ø 12	S Ø 12,7 (1/2")	D	B	R	L
E361.127.R	G361.127.R	12,7	13	3,2	51
E361.160.R	G361.160.R	16	13	3,2	51
E361.190.R	G361.190.R	19	13	3,2	51
E361.254.R	G361.254.R	25,4	13	3,2	51

HW UNDERMOUNT PROFILE BOWL BITS WITH BALL BEARING GUIDE Z=2

ART. E362 - G362

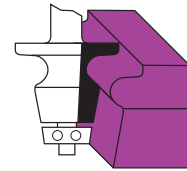
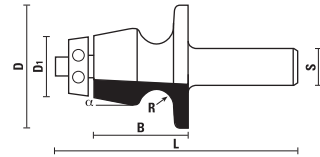
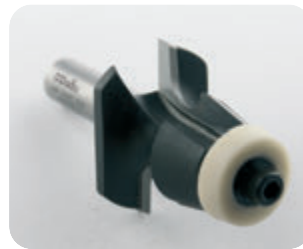

10° ball bearing with Delrin® ring

S Ø 12	S Ø 12,7 (1/2")	D	D1	B	R	L	α
E362.420.R	G362.420.R	42	22	33	6,4	84	10°



Z050.102.N



Z053.002.N



Z051.004.R

HW BEVEL HOB BITS WITH BALL BEARING GUIDE Z=2

ART. E363 - G363

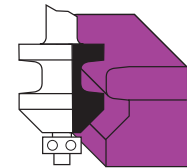
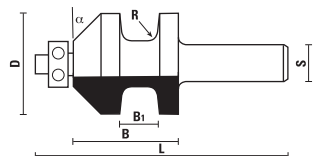

S Ø 12	S Ø 12,7 (1/2")	D	B	B1	R	L	α
E363.350.R	G363.350.R	35	36,5	12-13	3,2	89	45°



Z050.011.N



Z054.003.N



Z051.004.R

HW BEADING BITS Z=2

ART. E364 - G364

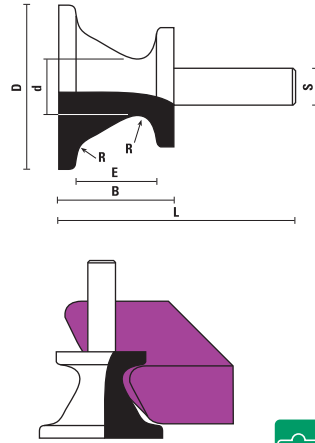

S Ø 12	S Ø 12,7 (1/2")	D	d	B	E	R	L
E364.370.R	G364.370.R	37	16	25	12-13	4,8	84
E364.540.R	G364.540.R	54	19	37	24-26	6,4	96
E364.710.R	G364.710.R	71	22	50	36-39	9,5	109

HW TRIPLE BEADING BITS WITH BALL BEARING GUIDE Z=2

ART. E365 - G365

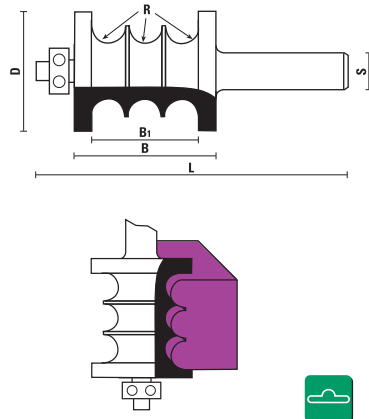

S Ø 12	S Ø 12,7 (1/2")	D	B	B1	R	L
E365.410.R	G365.410.R	41	51	39	6	101

HW DOUBLE BEADING BITS WITH BALL BEARING GUIDE Z=2

ART. E366 - G366

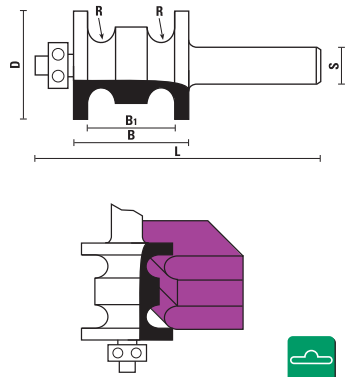

S Ø 12	S Ø 12,7 (1/2")	D	B	B1	R	L
E366.380.R	G366.380.R	38	51	38	6	79

HW MULTI BEADING BITS WITH BALL BEARING GUIDE Z=2

ART. E367 - G367

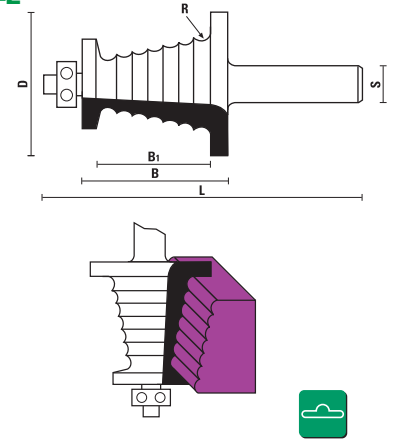

S Ø 12	S Ø 12,7 (1/2")	D	B	B1	R	L
E367.510.R	G367.510.R	51	51	38	3	99

HW EDGE Moulding BITS WITH BALL BEARING GUIDE Z=2

ART. E368 - G368

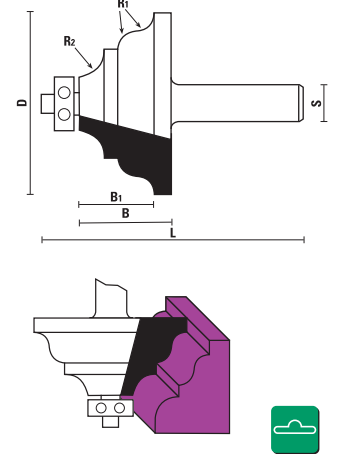

S Ø 12	S Ø 12,7 (1/2")	D	B	B1	R1	R2	L
E368.635.R	G368.635.R	63,5	32	27	6,4	9,5	81

HW EDGE Moulding BITS WITH BALL BEARING GUIDE Z=2

ART. E369 - G369

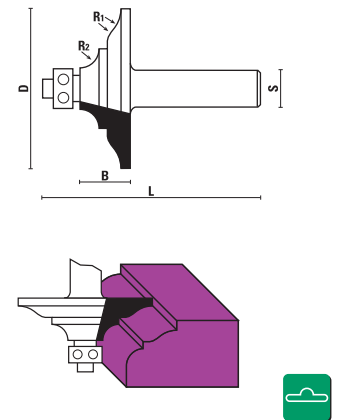

S Ø 12	S Ø 12,7 (1/2")	D	B	R1	R2	L
E369.635.R	G369.635.R	63,5	22	15	7,5	70

HW EDGE MOULDING BITS WITH BALL BEARING GUIDE Z=2

ART. E370 - G370

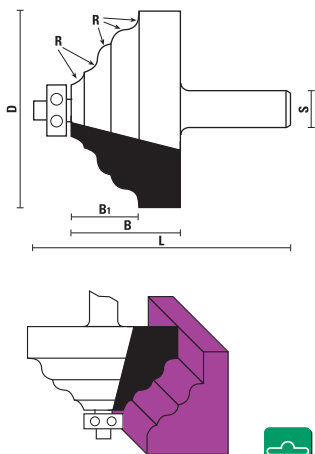

S Ø 12	S Ø 12,7 (1/2")	D	B	B1	R	L
E370.700.R	G370.700.R	70	40	33	4,8	87



Z050.101.N



Z053.002.N



Z051.004.R

HW WAVY EDGE BITS WITH BALL BEARING GUIDE Z=2

ART. E371 - G371

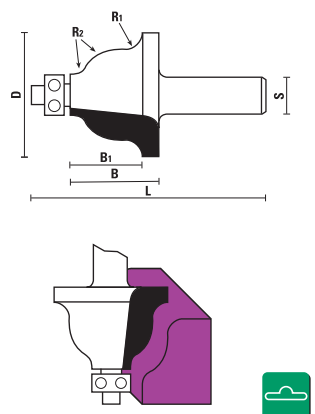

S Ø 12	S Ø 12,7 (1/2")	D	B	B1	R1	R2	L
E371.440.R	G371.440.R	44	32	25	6	13	82,5



Z050.100.N



Z053.002.N



Z051.002.R

HW EDGE MOULDING BITS WITH BALL BEARING GUIDE Z=2

ART. E372 - G372

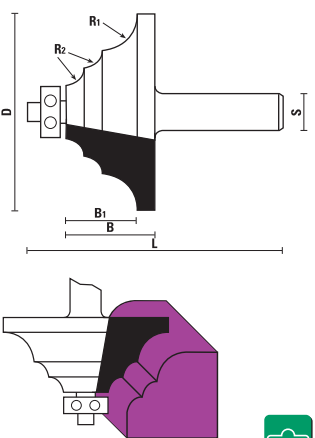

S Ø 12	S Ø 12,7 (1/2")	D	B	B1	R1	R2	L
E372.700.R	G372.700.R	70	33	25	12,7	6,4	79



Z050.101.N



Z053.002.N



Z051.004.R

HW EDGE MOULDING BITS WITH BALL BEARING GUIDE Z=2

ART. E373 - G373

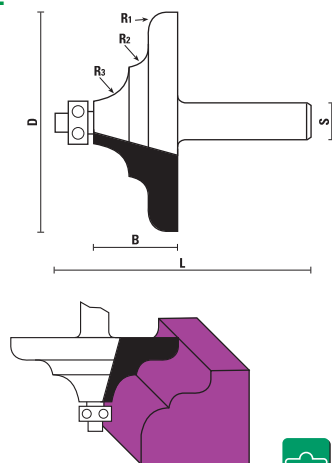

S Ø 12	S Ø 12,7 (1/2")	D	R1	R2	R3	B	L
E373.760.R	G373.760.R	76	6,4	6	12,7	30	78



Z050.100.N



Z053.002.N



Z051.002.R

HW EDGE MOULDING BITS WITH BALL BEARING GUIDE Z=2

ART. E374 - G374

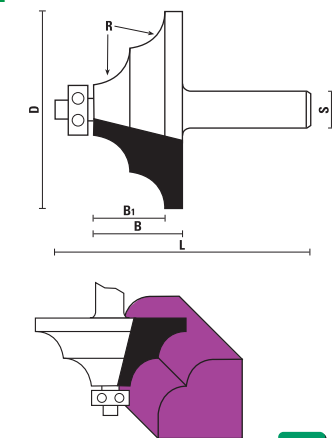

S Ø 12	S Ø 12,7 (1/2")	D	B	B1	R	L
E374.700.R	G374.700.R	70	32	25	12,7	82,5



Z050.101.N



Z053.002.N



Z051.004.R

HW ROMAN OGEE BITS WITH BALL BEARING GUIDE Z=2

ART. E375 - G375

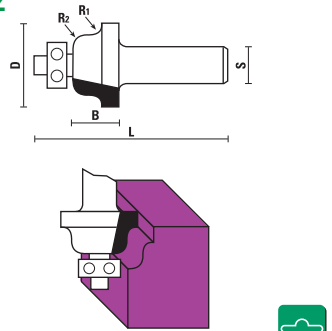

S Ø 12	S Ø 12,7 (1/2")	D	B	R1	R2	L
E375.286.R	G375.286.R	28,6	16	3,2	4	63,5



Z050.100.N



Z053.002.N



Z051.002.R

HW EDGE MOULDING BITS WITH BALL BEARING GUIDE Z=2

ART. E376 - G376

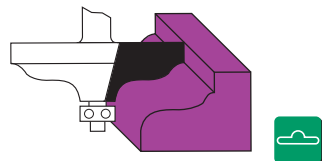
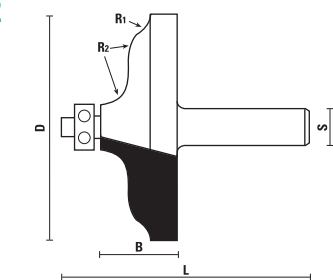

S Ø 12	S Ø 12,7 (1/2")	D	B	R1	R2	L
E376.790.R	G376.790.R	79	28	5,2	9	74,5



Z050.100.N



Z053.002.N



Z051.002.R

HW EDGE MOULDING BITS WITH BALL BEARING GUIDE Z=2

ART. E377 - G377

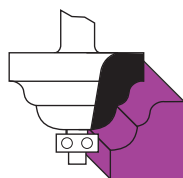
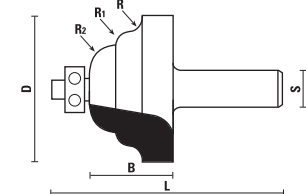

S Ø 12	S Ø 12,7 (1/2")	D	R	R1	R2	B	L
E377.510.R	G377.510.R	51	4,4	4,4	9,5	28	82,5



Z050.100.N



Z053.002.N



Z051.002.R

HW EDGE MOULDING BITS WITH BALL BEARING GUIDE Z=2

ART. E378 - G378

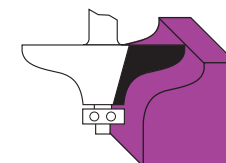
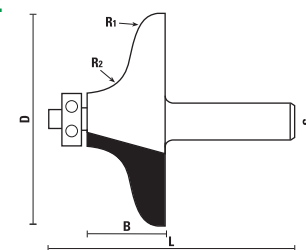

S Ø 12	S Ø 12,7 (1/2")	D	B	R1	R2	L
E378.760.R	G378.760.R	76	28	8	12,7	79



Z050.101.N



Z053.002.N



Z051.004.R

HW BEVEL BITS WITH BALL BEARING GUIDE Z=2

ART. E380 - G380

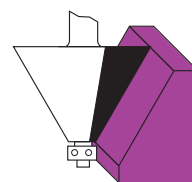
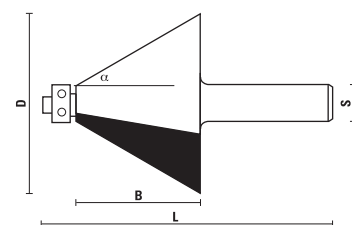
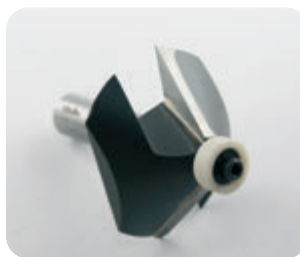

S Ø 12	S Ø 12,7 (1/2")	D	B	L	α
E380.510.R	G380.510.R	51	19	67	45°
E380.640.R	G380.640.R	64	44	93	30°



Z050.100.N



Z053.002.N



Z051.002.R

HW EDGE MOULDING BITS WITH BALL BEARING GUIDE Z=2

ART. E381 - G381

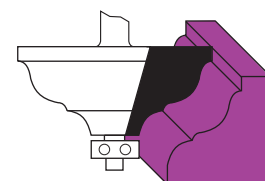
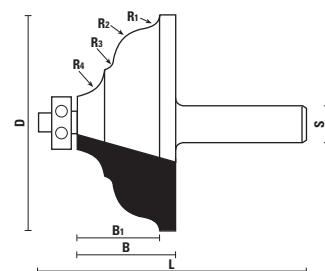

S Ø 12	S Ø 12,7 (1/2")	D	B	B1	R1	R2	R3	R4	L
E381.760.R	G381.760.R	76	34,9	29	4,8	12,7	3,2	9,5	84



Z050.101.N



Z053.002.N



Z051.004.R

HW CIRCULAR SAWBLADES

ART. MES

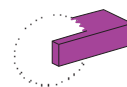

See also Art. MES section 12 page 12.34

HW ROUTER BITS FOR SINK REPAIRING

ART. E382 - G382

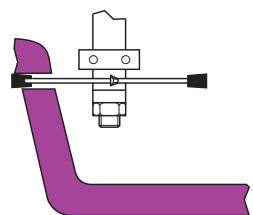
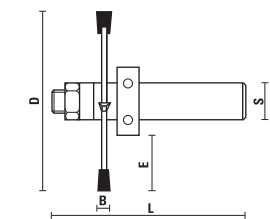

S Ø 12	S Ø 12,7 (1/2")	D	E	B	L	Z
E382.670.R	G382.670.R	80	25,7	6	96	4

Spare parts

Spare arbor

E117.120.N

Spare cutter D = Ø 80/Ø 8 Z=4

C118.980.R



Z050.112.N

HW ROUNDING OVER UNDERMOUNT BOWL BITS WITH BALL BEARING GUIDE Z=2

ART. E383 - G383

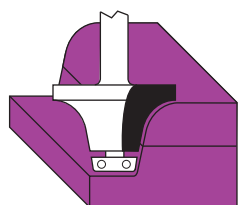
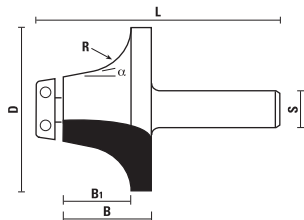
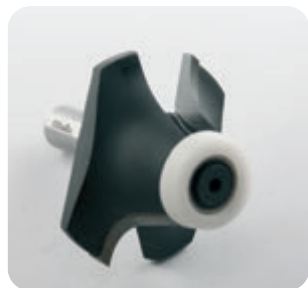

17° ball bearing with Delrin® ring

S Ø 12	S Ø 12,7 (1/2")	D	B	B1	R	L	alpha
E383.450.R	G383.450.R	45	17,5	13,5	9,5	63,5	17°
E383.510.R	G383.510.R	51	17,5	13,5	12,7	63,5	17°
E383.540.R	G383.540.R	54	25	20	12,7	73	17°
E383.570.R	G383.570.R	57	25	20	19	76	17°



Z050.120.N

HW ROUNDING OVER UNDERMOUNT BOWL BITS WITH BALL BEARING GUIDE Z=2

ART. E384 - G384

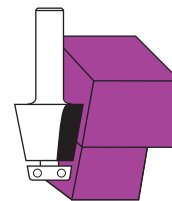
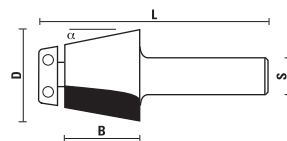

12° ball bearing with Delrin® ring

S Ø 12	S Ø 12,7 (1/2")	D	B	L	alpha
E384.320.R	G384.320.R	32	25	76	12°



Z050.102.N

INSERT FLUSH TRIM BITS Z=2

ART. W138

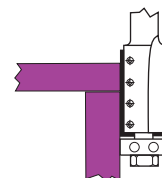
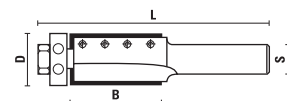

- HW knives with "Kawedur" coating
- For CORIAN®
- Ball bearing with Delrin® ring

S Ø 12	D	B	L
W138.190.R	19	30	82



Z050.111.N



Z055.230.N



Z051.101.N

INSERT FLUSH TRIM BITS Z=2

ART. W138

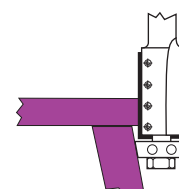
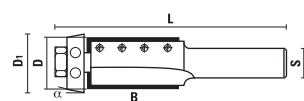

- HW knives with "Kawedur" coating
- For CORIAN®
- 11° ball bearing with Delrin® ring

S Ø 12	D	D1	B	L	alpha
W138.220.R	19	22	30	82	11°



Z050.110.N



Z055.230.N



Z051.101.N

HW/HS STRAIGHT PLUNGE CUTTING BITS FOR "ELU" Z=2

ART. F101 - F202

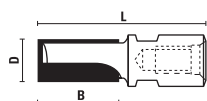

S = M12x1	D	B	L	Mat.
F101.060.R	6	18	60	HW
F101.070.R	7	20	60	HW
F101.080.R	8	25	60	HW
F101.100.R	10	25	60	HW
F101.120.R	12	25	60	HW
F101.140.R	14	25	60	HW
F101.150.R	15	25	60	HW
F101.160.R	16	25	60	HW
F101.180.R	18	25	60	HW
F101.200.R	20	25	60	HW
F101.220.R	22	25	60	HW
F101.240.R	24	25	60	HW
F101.250.R	25	25	60	HW
F101.300.R	30	25	60	HW

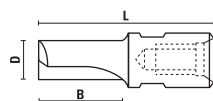

S = M12x1	D	B	L	Mat.
F202.100.R	10	25	60	HS
F202.120.R	12	25	60	HS
F202.160.R	16	25	60	HS
F202.200.R	20	25	60	HS
F202.220.R	22	25	60	HS
F202.240.R	24	25	60	HS

HW STRAIGHT PLUNGE CUTTING BITS FOR "ELU" Z=2

ART. F103 - F104 - F105

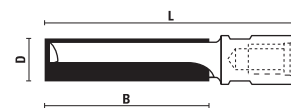

Long execution

S = M12x1	D	B	L
F103.080.R	8	35	67
F103.100.R	10	35	67
F103.120.R	12	35	67
F103.140.R	14	35	67
F103.160.R	16	35	67
F103.180.R	18	35	67
F103.200.R	20	35	67
F103.220.R	22	35	67
F104.120.R	12	45	77
F104.150.R	15	45	77
F104.160.R	16	45	77
F104.161.R	16	50	82
F104.180.R	18	45	77
F104.200.R	20	45	77
F105.140.R	14	60	92
F105.160.R	16	60	92
F105.180.R	18	60	92
F105.200.R	20	60	92
F105.220.R	22	60	92

HS STRAIGHT PLUNGE CUTTING BITS FOR "ELU" Z=2

ART. F203 - F204

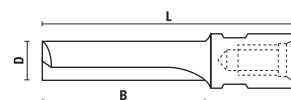

Long execution

S = M12x1	D	B	L
F203.120.R	12	45	77
F203.150.R	15	45	77
F203.160.R	16	45	77
F203.200.R	20	45	77
F204.160.R	16	60	92
F204.200.R	20	60	92
F204.240.R	24	60	92

HW STRAIGHT PLUNGE CUTTING BITS FOR "SCHEER" Z=2

ART. F152 - F153

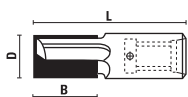

S = M10x1,5	D	B	L
F152.040.R	4	10	55
F152.050.R	5	12	55
F152.060.R	6	14	55
F152.080.R	8	20	55
F152.100.R	10	22	55
F152.120.R	12	22	55
F152.140.R	14	25	55
F152.150.R	15	25	55
F152.160.R	16	25	55
F152.180.R	18	25	55
F152.200.R	20	25	55
F152.220.R	22	25	55
F152.240.R	24	25	55
F152.250.R	25	25	55
F152.300.R	30	25	55

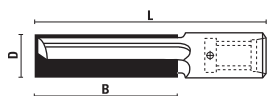

Long execution



S = M10x1,5	D	B	L
F153.060.R	6	30	65
F153.080.R	8	35	70
F153.100.R	10	35	70
F153.120.R	12	35	70
F153.140.R	14	35	70
F153.160.R	16	45	75
F153.180.R	18	45	75
F153.200.R	20	45	75
F153.220.R	22	45	75

HS STRAIGHT PLUNGE CUTTING BITS FOR "SCHEER" Z=2

ART. F252 - F253

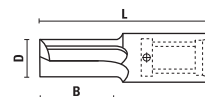

S = M10x1,5	D	B	L
F252.100.R	10	20	55
F252.120.R	12	20	55
F252.160.R	16	25	55
F252.200.R	20	27	55
F252.220.R	22	27	55

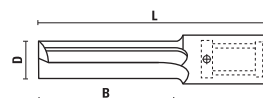

Long execution



S = M10x1,5	D	B	L
F253.120.R	12	40	70
F253.160.R	16	45	75
F253.200.R	20	45	75
F253.220.R	22	45	75

HW DRILL BITS FOR "FESTOOL" MACHINES Z=2

ART. F160

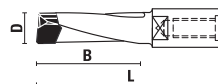

To use on router machines for "Domino" joints

S = M6x0,75	D	B	L
F160.050.R	5	20	49
F160.060.R	6	28	49
F160.080.R	8	28	49
F160.100.R	10	28	49



HW FLUSH TRIMMING BITS WITH BALL BEARING GUIDE Z=2

ART. F108

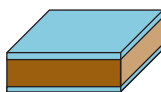
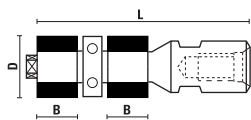

S = M12x1	D	B	L
F108.190.R	19	20	75



Z050.020.N

HW RADIUS BITS Z=2

ART. F110

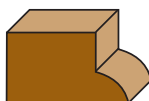
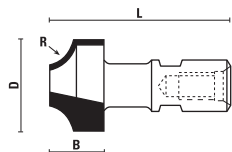

S = M12x1	D	R	B	L
F110.320.R selling out	32	10	15	60
F110.370.R selling out	37	12	18	60

HW RADIUS BITS WITH BALL BEARING GUIDE Z=2

ART. F111

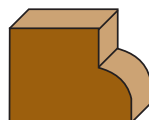
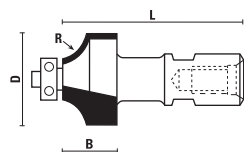

S = M12x1	D	R	B	L
F111.290.R	29	8	13	60
F111.330.R	33	10	15	60
F111.370.R	37	12	17	60
F111.430.R	43	15	20	60
F111.530.R	53	20	25	60

HW RADIUS BITS Z=2

ART. F112

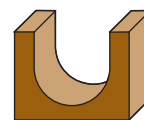
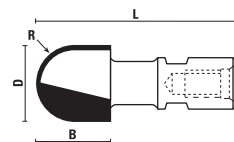

S = M12x1	D	R	B	L
F112.160.R	16	8	18	60
F112.200.R	20	10	18	60
F112.240.R	24	12	18	60
F112.300.R	30	15	18	60

HW RADIUS BITS Z=2

ART. F114

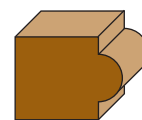
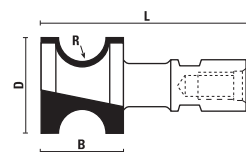

S = M12x1	D	R	B	L
F114.450.R	45	15	50	80

Router bits for handportable machines economy line



4



HW STRAIGHT BITS Z=2
Page 4.03

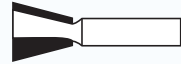

HW DOVETAIL BITS Z=2
Page 4.03

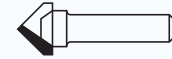

HW "V"-GROOVING BITS Z=2
Page 4.03

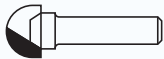

HW CORE BOX BITS Z=2
Page 4.03

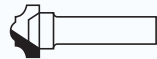

HW CLASSICAL BITS Z=2
Page 4.03

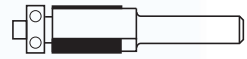

HW FLUSH TRIMMING BITS WITH BALL BEARING Z=2
Page 4.03

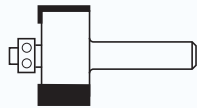

HW RABBETTING BITS WITH BALL BEARING Z=2
Page 4.03

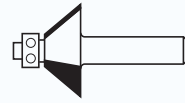

HW BEVEL TRIMMING BITS WITH BALL BEARING Z=2
Page 4.04

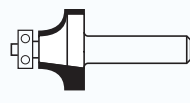

HW ROUNDING OVER BITS WITH BALL BEARING Z=2
Page 4.04

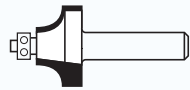

HW BEADING BITS WITH BALL BEARING Z=2
Page 4.04



HW COVE BITS WITH BALL BEARING Z=2
Page 4.04

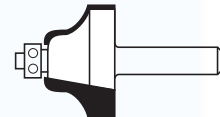

HW OGEE BITS WITH BALL BEARING Z=2
Page 4.04

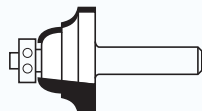

HW CLASSICAL BITS WITH BALL BEARING Z=2
Page 4.04



VHW FLUSH TRIMMER - Z=1
Page 4.05



VHW BEVEL TRIMMER - Z=1
Page 4.05



VHW COMBINATION FLUSH & BEVEL TRIMMER - Z=1
Page 4.05



VHW RIP & SLOTTING BITS - Z=1
Page 4.05



6 PIECE CLASSICAL HOBBY ROUTER BITS "STARTER SET"
Page 4.06



12 PIECE CLASSICAL HOBBY ROUTER BITS "ADVANCED SET"
Page 4.06



DISPLAY UNITS
Page 4.07



Klein®

HW STRAIGHT BITS Z=2

ART. HA101 - HB101 - HC101

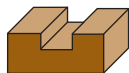
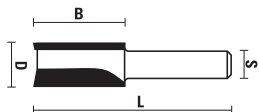

S Ø 6	S Ø 6,4 (1/4")	S Ø 8	D	B	L
HA101.050.R	HB101.050.R	HC101.050.R	5	12	48
HA101.060.R	HB101.060.R	HC101.060.R	6	20	48
HA101.080.R	HB101.080.R	HC101.080.R	8	20	48
HA101.100.R	HB101.100.R	HC101.100.R	10	20	48
HA101.120.R	HB101.120.R	HC101.120.R	12	20	48
HA101.127.R	HB101.127.R	HC101.127.R	12,7	20	48
HA101.140.R	HB101.140.R	HC101.140.R	14	20	48
HA101.160.R	HB101.160.R	HC101.160.R	16	20	48
HA101.180.R	HB101.180.R	HC101.180.R	18	20	48
HA101.190.R	HB101.190.R	HC101.190.R	19	20	48
HA101.200.R	HB101.200.R	HC101.200.R	20	20	48

HW DOVETAIL BITS Z=2

ART. HA108 - HB108 - HC108

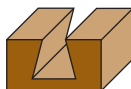
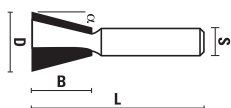

S Ø 6	S Ø 6,4 (1/4")	S Ø 8	D	B	α	L
HA108.127.R	HB108.127.R	HC108.127.R	12,7	13	14°	45

HW "V"-GROOVING BITS Z=2

ART. HA109 - HB109 - HC109
HA110 - HB110 - HC110

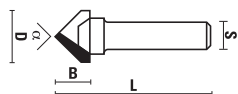

S Ø 6	S Ø 6,4 (1/4")	S Ø 8	D	B	α	L
HA109.127.R	HB109.127.R	HC109.127.R	12,7	8	90°	40
HA110.095.R	HB110.095.R	HC110.095.R	9,5	10	60°	42

HW CORE BOX BITS Z=2

ART. HA111 - HB111 - HC111

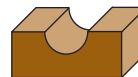
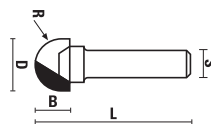

S Ø 6	S Ø 6,4 (1/4")	S Ø 8	D	B	R	L
HA111.064.R	HB111.064.R	HC111.064.R	6,4	5	3,2	47
HA111.127.R	HB111.127.R	HC111.127.R	12,7	8	6,4	47

HW CLASSICAL BITS Z=2

ART. HA115 - HB115 - HC115

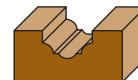
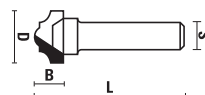

S Ø 6	S Ø 6,4 (1/4")	S Ø 8	D	B	L
HA115.127.R	HB115.127.R	HC115.127.R	12,7	8	40

HW FLUSH TRIMMING BITS WITH BALL BEARING Z=2

ART. HA119 - HB119 - HC119

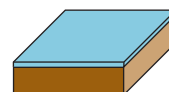
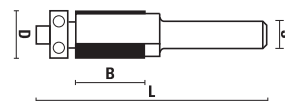

Ideal for working laminated panels

S Ø 6	S Ø 6,4 (1/4")	S Ø 8	D	B	L
HA119.127.R	HB119.127.R	HC119.127.R	12,7	13	54

HW RABBETING BITS WITH BALL BEARING Z=2

ART. HA121 - HB121 - HC121

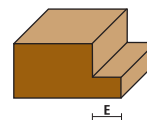
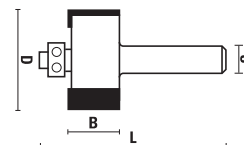

S Ø 6	S Ø 6,4 (1/4")	S Ø 8	D	B	E	L
HA121.286.R	HB121.286.R	HC121.286.R	28,6	13	9,5	47

HW BEVEL TRIMMING BITS WITH BALL BEARING Z=2

ART. HA122 - HB122 - HC122

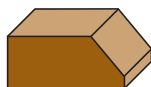
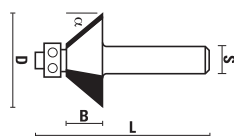

S Ø 6	S Ø 6,4 (1/4")	S Ø 8	D	B	α	L
HA122.160.R	HB122.160.R	HC122.160.R	16	6,5	25°	47
HA122.320.R	HB122.320.R	HC122.320.R	32	12,5	45°	47

HW ROUNDING OVER BITS WITH BALL BEARING Z=2

ART. HA123 - HB123 - HC123

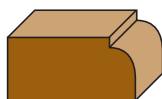
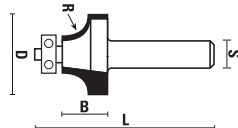

S Ø 6	S Ø 6,4 (1/4")	S Ø 8	D	B	R	L
HA123.158.R	HB123.158.R	HC123.158.R	15,8	10	3,2	44
HA123.220.R	HB123.220.R	HC123.220.R	22	13	6,3	46
HA123.250.R	HB123.250.R	HC123.250.R	25	15	8	49
HA123.286.R	HB123.286.R	HC123.286.R	28,6	17	9,5	50

HW BEADING BITS WITH BALL BEARING Z=2

ART. HA124 - HB124 - HC124

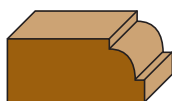
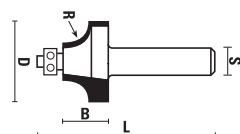

S Ø 6	S Ø 6,4 (1/4")	S Ø 8	D	B	R	L
HA124.158.R	HB124.158.R	HC124.158.R	15,8	10	3,2	44
HA124.220.R	HB124.220.R	HC124.220.R	22	13	6,3	46
HA124.250.R	HB124.250.R	HC124.250.R	25	15	8	49
HA124.286.R	HB124.286.R	HC124.286.R	28,6	17	9,5	50

HW COVE BITS WITH BALL BEARING Z=2

ART. HA125 - HB125 - HC125

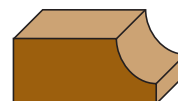
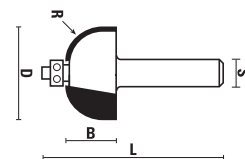

S Ø 6	S Ø 6,4 (1/4")	S Ø 8	D	B	R	L
HA125.220.R	HB125.220.R	HC125.220.R	22	13	6,3	47
HA125.286.R	HB125.286.R	HC125.286.R	28,6	14	9,5	48

HW OGEE BITS WITH BALL BEARING Z=2

ART. HA127 - HB127 - HC127

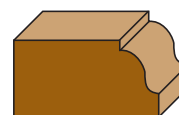
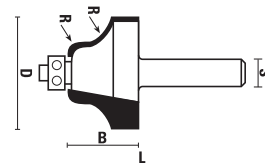

S Ø 6	S Ø 6,4 (1/4")	S Ø 8	D	B	R	L
HA127.250.R	HB127.250.R	HC127.250.R	25	16	4	50

HW CLASSICAL BITS WITH BALL BEARING Z=2

HA128 - HB128 - HC128

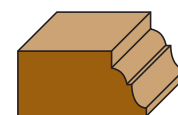
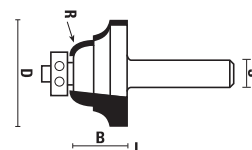

S Ø 6	S Ø 6,4 (1/4")	S Ø 8	D	B	R	L
HA128.250.R	HB128.250.R	HC128.250.R	25	16	4	50

VHW FLUSH TRIMMER - Z=1

ART. HB190

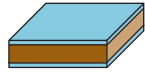

- Solid carbide
- Ideal for working laminated panels

S Ø 6,4 (1/4")	D	B	L
HB190.064.R	6,35	6,4	38
HB190.095.R	6,35	9,5	38
HB190.065.R - Testa rettificata	6,35	6,5	38
HB190.096.R - Testa rettificata	6,35	9,6	38

VHW COMBINATION FLUSH & BEVEL TRIMMER - Z=1

ART. HB192

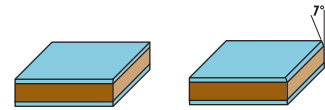
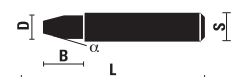

- Solid carbide
- Ideal for working laminated panels

S Ø 6,4 (1/4")	D	B	α	L
HB192.064.R	6,4	9,5	7°	38

VHW BEVEL TRIMMER - Z=1

ART. HB191

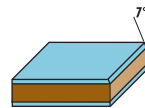
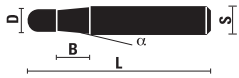

- Solid carbide
- Ideal for working laminated panels

S Ø 6,4 (1/4")	D	B	α	L
HB191.064.R	5	6,4	7°	38
HB191.065.R - top grind	5	6,5	7°	38

VHW RIP & SLOTTING BITS - Z=1

ART. HB193

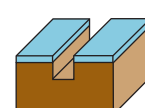

- Solid carbide
- Ideal for working laminated panels

S Ø 6,4 (1/4")	D	B	L
HB193.064.R	6,4	9,5	38

6 PIECE CLASSICAL HOBBY ROUTER BITS "STARTER SET"

ART. HX002



- Set including the 6 most popular hobby T.C.T. router bits in a robust and practical wooden box
- Ideal to have always on hand the right bit for straight cut, engraving and profiling

HX002.006.R (S Ø 6)		HX002.008.R (S Ø 8)	
HA101.060.R		HC101.060.R	
HA101.120.R		HC101.120.R	
HA109.127.R		HC109.127.R	
HA123.286.R		HC123.286.R	
HA124.220.R		HC124.220.R	
HA127.250.R		HC127.250.R	

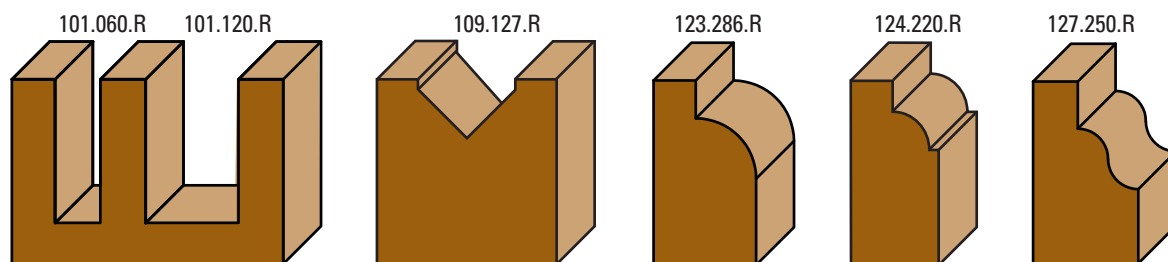

Scale 1:1

12 PIECE CLASSICAL HOBBY ROUTER BITS "ADVANCED SET"

ART. HX005



- Set including the 12 most popular hobby T.C.T. router bits in a robust and practical wooden box
- Ideal to have always on hand the right bit for straight cut, trimming, engraving, profiling and dovetail joints

HX005.006.R (S Ø 6)		HX005.008.R (S Ø 8)	
HA101.060.R	HA119.127.R	HC101.060.R	HC119.127.R
HA101.120.R	HA122.320.R	HC101.120.R	HC122.320.R
HA101.160.R	HA123.220.R	HC101.160.R	HC123.220.R
HA108.127.R	HA123.286.R	HC108.127.R	HC123.286.R
HA109.127.R	HA125.220.R	HC109.127.R	HC125.220.R
HA111.127.R	HA127.250.R	HC111.127.R	HC127.250.R

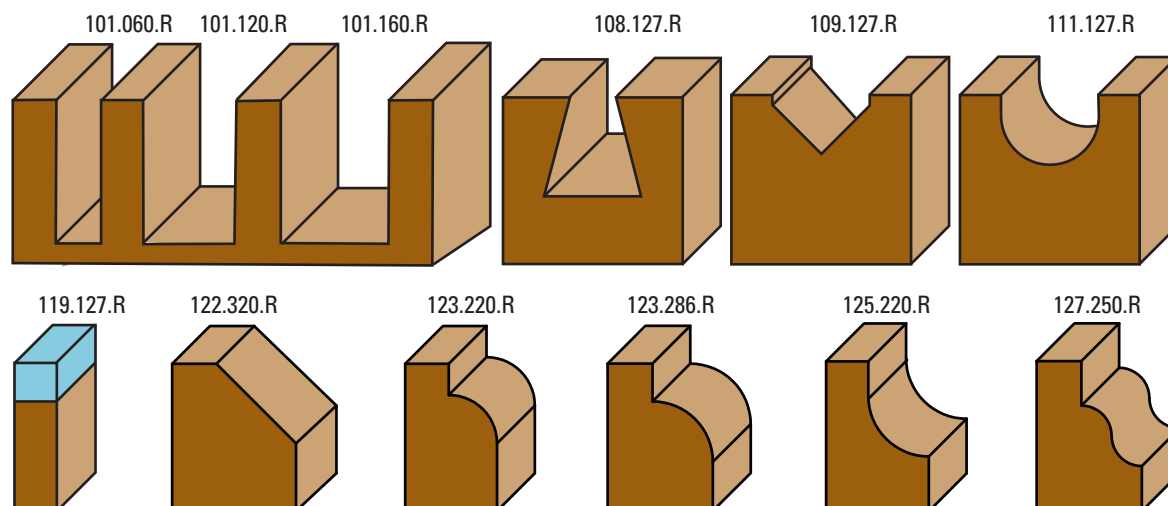

Scale 1:1

DISPLAY UNITS

BASE
1 modular panel

Little display unit, suitable for those who mean to start with a sufficient choice for a small number of customers.

Dimensions (cm): 110 (L) x 90 (H) x 30 (P)

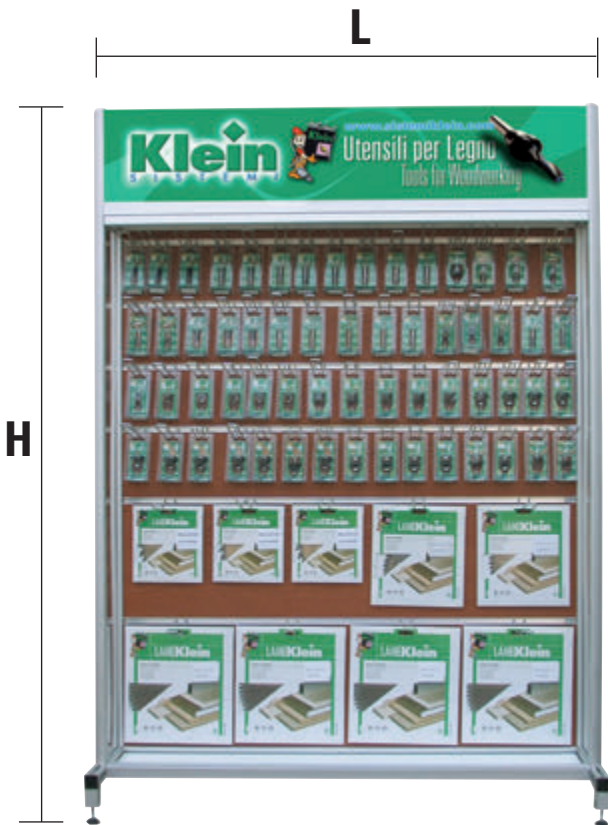

STANDARD
2 modular panels

Consisting of two "Basic model" displays, can be composed according to the customer's requirements. It is suitable for anyone who wants to have a good choice of items in view of improving his offer.

Dimensions (cm): 110 (L) x 145 (H) x 36 (P)

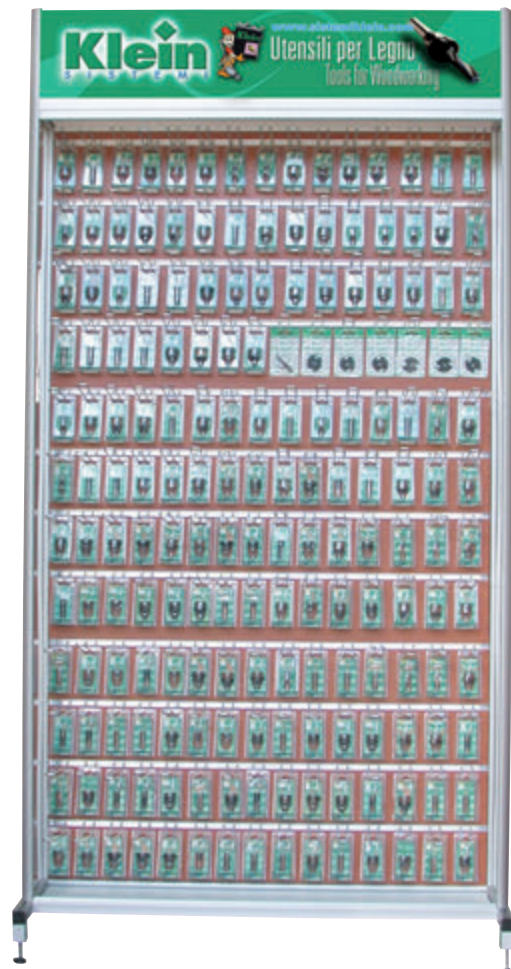

PROFESSIONAL
3 modular panels

Large display, consisting of three "Basic model" units allows you to show a wide choice of items.

By the combination of two or more displays, you can equip a wall and meet all professional woodworkers' requirements.

Dimensions (cm): 110 (L) x 200 (H) x 36 (P)

Dowel drills, boring bits for automatic boring machines



5

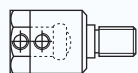

DRILL ADAPTORS
Page 5.04

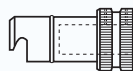

QUICK CHANGE DRILL HOLDERS
Page 5.05, 5.06

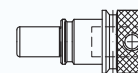

CHUCKS FOR MACHINES "BIESSE" WITH AUTOMATIC CHANGE
Page 5.06

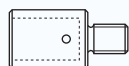

QUICK CHANGE CHUCKS
Page 5.06 - 5.07



HW DOWEL DRILLS Z=2
Page 5.07



HW THROUGH HOLE DRILL BITS Z=2
Page 5.07



HW DOWEL DRILLS Z=2
Page 5.08



HW DOWEL DRILLS Z=2
Page 5.08



HW DOWEL DRILLS Z=2
Page 5.09



HW DOWEL DRILLS EXTRA FINE Z=2
Page 5.10



HW DOWEL DRILLS EXTRA TIME Z=2
Page 5.11



VHW DOWEL DRILLS EXTRA TIME Z=2
Page 5.11



VHW DOWEL DRILLS Z=2
Page 5.12



DRILL HOLDER-SLEEVES
Page 5.12



VHW TWIST DRILLS Z=2
Page 5.12

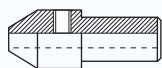

DRILL HOLDERS
Page 5.12

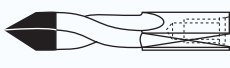

HW THROUGH HOLE DRILL BITS Z=2
Page 5.13



HW THROUGH HOLE DRILL BITS Z=2
Page 5.13



VHW THROUGH HOLE DRILL BITS Z=2
Page 5.14



HW COUNTERSINKS Z=2 - 90°
Page 5.14



VHW DOWEL DRILLS FOR BOTH RIGHT HAND AND LEFT HAND ROTATION Z=1
Page 5.14

Klein®



HW DOWEL DRILLS WITH
COUNTERSINK Z=2
Page 5.14



HW THROUGH HOLE DRILL BITS "E.T."
LINE Z=2
Page 5.15



VHW THROUGH HOLE DRILL BITS "E.T."
LINE Z=2
Page 5.15

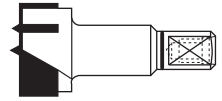

HW HINGE BORING BITS Z=2+2
Page 5.16

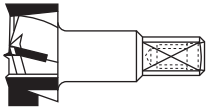

HW HINGE BORING BITS Z=3+3
Page 5.17

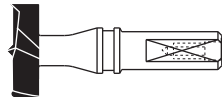

VHW HINGE BORING BITS Z=2+2
Page 5.17

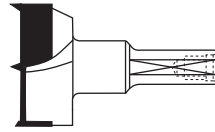

HW HINGE BORING BITS Z=2+2
Page 5.18

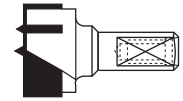

HW HINGE BORING BITS Z=2+2
Page 5.18



HW DOWEL DRILLS Z=2
Page 5.18

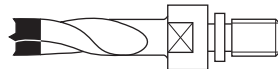

HW DOWEL DRILLS WITH THREADED
SHANK Z=2
Page 5.19



HW DOWEL DRILLS WITH COUNTERSINK
THREADED SHANK Z=2
Page 5.19



HW DOWEL DRILLS WITH THREADED
SHANK Z=2
Page 5.20



HW DOWEL DRILLS WITH COUNTERSINK
THREADED SHANK Z=2
Page 5.20

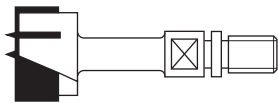

HW HINGE BORING BITS WITH THREADED
SHANK Z=2+2
Page 5.20



HW HINGE BORING BITS WITH THREADED
SHANK Z=2+2
Page 5.20

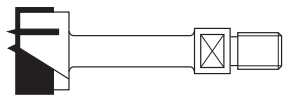

HW HINGE BORING BITS WITH
THREADED SHANK Z=2+2
Page 5.20

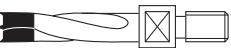

HW DOWEL DRILLS WITH THREADED
SHANK Z=2
Page 5.21



HW DOWEL DRILLS WITH THREADED
SHANK Z=2
Page 5.21



HW/HS COUNTERBORE BITS
Page 5.21



MODULAR DRAWER UNIT
Page 5.22

DRILLING

The experience of **SISTEMI** is being always available to its customers in choosing the right tool for the desired processing. In this regard, a wide range of factors must be taken into consideration. Here is a summary list:

- 1) In addition to the traditional drilling bits with brazed carbide tips sometimes it is important to evaluate the use of **solid carbide drills** (Art. L116/L117/L118/L129/L134/L135) **that can ensure performance benefits**, longer life, higher number of resharpening times and higher resistance to breakage of tool body;
- 2) Choosing the drill bit according to the working material by properly setting RPM and feed speed as indicated in the following tables help to optimize the process;
- 3) To reduce the time of assembly and align the drills, **we recommend using our quick change drill chucks** (Art. L030 ÷ L060);
- 4) **Regular cleaning and maintenance** of the drills and adaptors **improve the performance and life of tools**, reducing the risk of breakage and increasing the quality of the worked pieces;
- 5) To improve the chips flow, the boring bits are coated with a **PTFE-based heat treatment** (Polytetrafluoroethylene) in black for Right Rotation and orange for Left Rotation.



How to choose the right Boring Bits

Types of material Items	Softwood (Cider, Poplar, Pine, etc.)	Hardwood (Ash, Walnut, Beech, Oak, Teak, etc.)	Pressed Wood (Plywood, Blockboard)	Chipboard	Laminated Wood (Veneered, melamine coated panels, HPL, etc.)	MDF	Trespa®
L101/L102/L103/L104 - Page 5.07, 5.08	XX	XX	XX	XX	X	XX	
L105/L106/L107/L108 - Page 5.08	XX	XX	XX	XX	X	XX	
L109/L110 - Page 5.09	XX	XX	XX	XX	X	XX	
L112/L113 - Page 5.10	XX	XX	XXX	XXX	XXX	XXX	
L114/L115/L116/L117 - Page 5.11	XX	XX	XXX	XXX	XXX	XXX	X
L118 - Page 5.12	X	X	X	X	X	XX	XXX
L132/L133 - Page 5.15	XXX	XXX	XXX	XXX	XXX	XXX	XX
L134/L135 - Page 5.15	XXX	XXX	XXX	XXX	XXX	XXX	XX
L120 - Page 5.12	XX	XX	XX	XX	XX	XX	X
L121/L122/L123/L124 - Page 5.07, 5.13	XX	XX	XX	XX	X	XX	
L125/L126/L127 - Page 5.13	XX	XX	XX	XX	X	XX	
L129 - Page 5.14	XXX	XXX	XXX	XXX	XX	XXX	X
L140/L141/L142 - Page 5.16	XX	XX	XXX	XXX	XX	XX	
L143/L144/L150/L151 - Page 5.17	XX	XX	XXX	XXX	X	XX	
L155 - Page 5.17	XXX	XXX	XXX	XXX	XXX	XXX	XX
L160/L170 - Page 5.18	XX	XX	XXX	XXX	XX	XX	

X = Satisfactory - **XX** = Good - **XXX** = Excellent

Technical data and images are just an indication. **SISTEMI** srl reserves the right to modify the above information at any time and without notice.

DRILL ADAPTORS

ART. L001 - M10/11x4

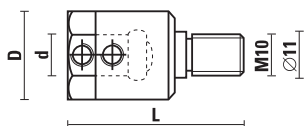

For: MORBIDELLI, BIESSE, WEEKE

RH rotation	LH rotation	d	D	L
L001.080.R	L001.080.L	8	15,5	41
L001.100.R	L001.100.L	10	19,5	41



Z051.301.R

DRILL ADAPTORS

ART. L004 - M8/9x3

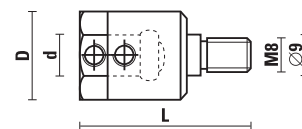

For: MORBIDELLI, NOTTMEYER

RH rotation	LH rotation	d	D	L
L004.080.R	L004.080.L	8	15,5	41
L004.100.R	L004.100.L	10	19,5	41
L004.101.R	L004.101.L	10	15	41



Z051.301.R

DRILL ADAPTORS

ART. L002 - M10/Taper 30°

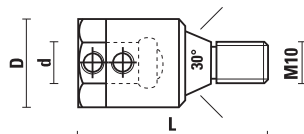

For: VITAP, BUSELLATO, SCHLEICHER

RH rotation	LH rotation	d	D	L
L002.080.R	L002.080.L	8	15,5	46
L002.100.R	L002.100.L	10	19,5	46



Z051.301.R

DRILL ADAPTORS

ART. L005 - M8

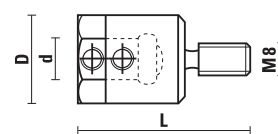

For: NOTTMEYER

RH rotation	LH rotation	d	D	L
L005.080.R	L005.080.L	8	15,5	40
L005.100.R	L005.100.L	10	19,5	40



Z051.301.R

DRILL ADAPTORS

ART. L003 - M10

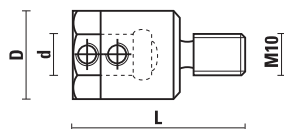

For: AYEN, HOLZMA, MAYER

RH rotation	LH rotation	d	D	L
L003.080.R	L003.080.L	8	15,5	40
L003.100.R	L003.100.L	10	19,5	40



Z051.301.R

DRILL ADAPTORS

ART. L006 - M8 - 20°48'

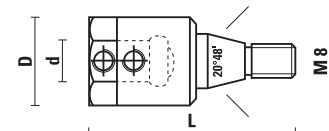

For: BILEK

RH rotation	LH rotation	d	D	L
L006.080.R	L006.080.L	8	15,5	51
L006.100.R	L006.100.L	10	19,5	51



Z051.301.R

QUICK CHANGE DRILL HOLDERS

ART. L030

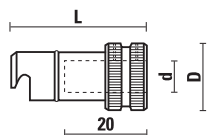

For: **BIESSE**

RH rotation	LH rotation	d	D	L
L030.100.R	L030.100.L	10	20	37
L030.101.R	L030.101.L lowered	10	20	30
L030.102.R	L030.102.L threaded	M10	20	37



Z051.314.R

QUICK CHANGE DRILL HOLDERS

ART. L031

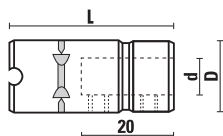

For: **MORBIDELLI**

RH rotation	LH rotation	d	D	L
L031.100.R		10	20	43
L031.101.R lowered		10	16	43
L031.102.R	L031.102.L threaded	M10	20	43



Z051.314.R
(L031.100.R)



Z051.313.R
(L031.101.R)

QUICK CHANGE DRILL HOLDERS

ART. L031

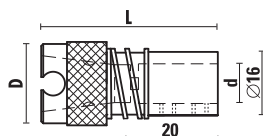

For: **MORBIDELLI** machines, with pull out spring

Item	d	D	L
L031.500.R	10	20	44



Z051.301.R

ADAPTORS

ART. L031

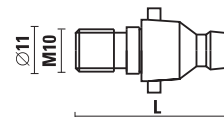

- Adaptor for quick change chucks
- For: **MORBIDELLI, SCM** with shank M10/11
- Use with: **Art. L031.100.R** and/or **Art. L031.500.R**

RH rotation	LH rotation	L
L031.600.R	L031.600.L	37

QUICK CHANGE DRILL HOLDERS

ART. L032

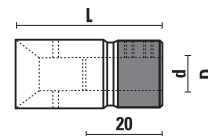

For: **MASTERWOOD, MAGGI, GRIGGIO**

Item	d	D	L
L032.100.R	10	20	40

For: **MINIMAX**

Item	d	D	L
L032.200.R NEW	10	20	40



Z051.301.R

QUICK CHANGE DRILL HOLDERS

ART. L033

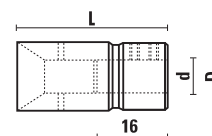

For: **VITAP**

Item	d	D	L
L033.100.R	10	18	42



Z051.313.R

QUICK CHANGE DRILL HOLDERS

ART. L034

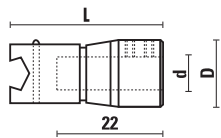

For: **BUSELLATO**

Item	d	D	L
L034.100.R	10	19	34,5



Z051.313.R

QUICK CHANGE DRILL HOLDERS

ART. L035

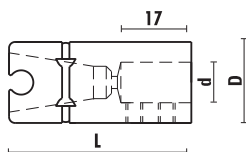

For: **DETEL**

Item	d	D	L
L035.100.R	10	20	45



Z051.314.R

QUICK CHANGE DRILL HOLDER

ART. L036

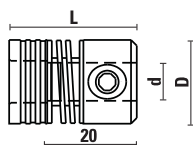

For: **GRASS**

Item	d	D	L
L036.100.R	10	22	38,5



Z051.304.R

CHUCKS FOR MACHINES "BIESSE" WITH AUTOMATIC CHANGE

ART. L060

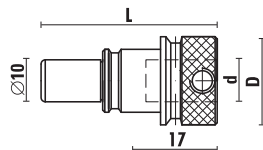

Item	d	D	L
L060.100.N	10	21	42



Z051.314.R

QUICK CHANGE DRILL HOLDERS

ART. L040

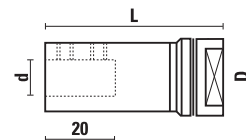

For: **WEEKE**

Item	d	D	L
L040.100.R	10	20	46
L040.101.R	10	20	56
L040.102.R	10	20	66



Z051.314.R

QUICK CHANGE CHUCKS

ART. L050

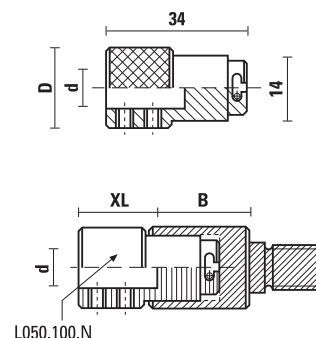

For art.: **L051 - L052 - L053 - L054**

Item	d	D	XL
L050.100.N	10	18	17,5



Z051.301.R

QUICK CHANGE CHUCKS

ART. L051

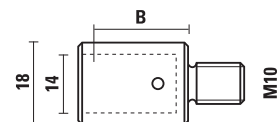

For: **AYEN, HOLZMA**

RH rotation	LH rotation	B
L051.100.R	L051.100.L	22,5

QUICK CHANGE CHUCKS

ART. L052

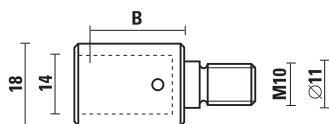

For: MORBIDELLI, BIESSE, WEEKE, BUSELLATO, TORWEGGE

RH rotation	LH rotation	B
L052.100.R	L052.100.L	22,5

QUICK CHANGE CHUCKS

ART. L053

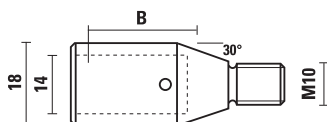

For: VITAP, ALBERTI

RH rotation	LH rotation	B
L053.100.R	L053.100.L	25,5

QUICK CHANGE CHUCKS

ART. L054

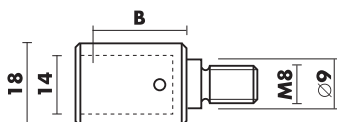

For: NOTTMEYER

RH rotation	LH rotation	B
L054.100.R	L054.100.L	25,5

HW DOWEL DRILLS Z=2

ART. L101 - L102

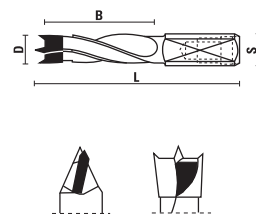

- 4-flutes
- Spurs ground with negative cutting angle for a good finish
- PTFE-Based coating for a better chip flow
- For natural wood, pressed wood, veneered, chipboard, laminated and MDF
- Can be used on **Mafell** drilling machines

RH rotation	LH rotation	D	B	L	S
L101.050.R	L101.050.L	5	30	55,5	8X20
L101.060.R	L101.060.L	6	30	55,5	8X20
L101.070.R	L101.070.L	7	30	55,5	8X20
L101.080.R	L101.080.L	8	30	55,5	8X20
L101.090.R	L101.090.L	9	30	55,5	8X20
L101.100.R	L101.100.L	10	30	55,5	8X20
L101.120.R	L101.120.L	12	30	55,5	8X20
L102.050.R	L102.050.L	5	40	67	8X20
L102.060.R	L102.060.L	6	40	67	8X20
L102.070.R	L102.070.L	7	40	67	8X20
L102.080.R	L102.080.L	8	40	67	8X20
L102.090.R	L102.090.L	9	40	67	8X20
L102.100.R	L102.100.L	10	40	67	8X20
L102.120.R	L102.120.L	12	40	67	8X20



Z051.302.R

HW THROUGH HOLES DRILL BITS Z=2

ART. L121 - L122

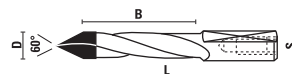

- 2-flutes
- PTFE-Based coating for a better chip flow
- For natural wood, pressed wood, veneered, chipboard, laminated and MDF

RH rotation	LH rotation	D	B	L	S
L121.050.R	L121.050.L	5	25	55,5	8X20
L121.080.R	L121.080.L	8	25	55,5	8X20
L122.050.R	L122.050.L	5	35	67	8X20
L122.080.R	L122.080.L	8	35	67	8X20



Z051.302.R

HW DOWEL DRILLS Z=2

ART. L103 - L104

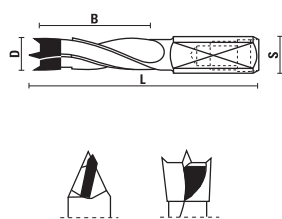

- 4-flutes (∅4 with 2 flutes)
- Spurs ground with negative cutting angle for a good finish
- PTFE-Based coating for a better chip flow
- For natural wood, pressed wood, veneered, chipboard, laminated and MDF

RH rotation	LH rotation	D	B	L	S
L103.040.R	L103.040.L	4	30	57,5	10X20
L103.050.R	L103.050.L	5	30	57,5	10X20
L103.055.R	L103.055.L	5,5	30	57,5	10X20
L103.060.R	L103.060.L	6	30	57,5	10X20
L103.064.R	L103.064.L	6,4	30	57,5	10X20
L103.070.R	L103.070.L	7	30	57,5	10X20
L103.075.R	L103.075.L	7,5	30	57,5	10X20
L103.080.R	L103.080.L	8	30	57,5	10X20
L103.085.R	L103.085.L	8,5	30	57,5	10X20
L103.090.R	L103.090.L	9	30	57,5	10X20
L103.095.R	L103.095.L	9,5	30	57,5	10X20
L103.100.R	L103.100.L	10	30	57,5	10X20
L103.105.R	L103.105.L	10,5	30	57,5	10X20
L103.110.R	L103.110.L	11	30	57,5	10X20
L103.120.R	L103.120.L	12	30	57,5	10X20
L103.127.R	L103.127.L	12,7	30	57,5	10X20
L103.130.R	L103.130.L	13	30	57,5	10X20
L103.140.R	L103.140.L	14	30	57,5	10X20
L103.150.R	L103.150.L	15	30	57,5	10X20
L103.160.R	L103.160.L	16	30	57,5	10X20
L104.040.R	L104.040.L	4	43	70	10X20
L104.050.R	L104.050.L	5	43	70	10X20
L104.055.R	L104.055.L	5,5	43	70	10X20
L104.060.R	L104.060.L	6	43	70	10X20
L104.064.R	L104.064.L	6,4	43	70	10X20
L104.070.R	L104.070.L	7	43	70	10X20
L104.075.R	L104.075.L	7,5	43	70	10X20
L104.080.R	L104.080.L	8	43	70	10X20
L104.082.R	L104.082.L	8,2	43	70	10X20
L104.085.R	L104.085.L	8,5	43	70	10X20
L104.090.R	L104.090.L	9	43	70	10X20
L104.095.R	L104.095.L	9,5	43	70	10X20
L104.100.R	L104.100.L	10	43	70	10X20
L104.105.R	L104.105.L	10,5	43	70	10X20
L104.110.R	L104.110.L	11	43	70	10X20
L104.120.R	L104.120.L	12	43	70	10X20
L104.127.R	L104.127.L	12,7	43	70	10X20
L104.130.R	L104.130.L	13	43	70	10X20
L104.140.R	L104.140.L	14	43	70	10X20
L104.150.R	L104.150.L	15	43	70	10X20



Z051.302.R

On request



Z051.505.R

HW DOWEL DRILLS Z=2

ART. L105 - L106 - L107 - L108

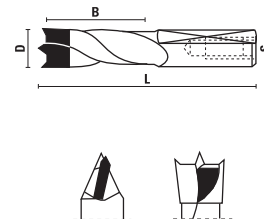

- 2-flutes
- Spurs ground with negative cutting angle for a good finish
- PTFE-Based coating for a better chip flow
- For natural wood, pressed wood, veneered, chipboard, laminated and MDF

RH rotation	LH rotation	D	B	L	S
L105.040.R	L105.040.L	4	27	57,5	10x27
L105.045.R	L105.045.L	4,5	27	57,5	10x27
L105.050.R	L105.050.L	5	27	57,5	10x27
L105.052.R	L105.052.L	5,2	27	57,5	10x27
L105.060.R	L105.060.L	6	27	57,5	10x27
L105.064.R	L105.064.L	6,4	27	57,5	10x27
L105.070.R	L105.070.L	7	27	57,5	10x27
L105.080.R	L105.080.L	8	27	57,5	10x27
L105.082.R	L105.082.L	8,2	27	57,5	10x27
L105.090.R	L105.090.L	9	27	57,5	10x27
L105.095.R	L105.095.L	9,5	27	57,5	10x27
L105.100.R	L105.100.L	10	27	57,5	10x27
L105.110.R	L105.110.L	11	27	57,5	10x27
L105.120.R	L105.120.L	12	27	57,5	10x27
L105.127.R	L105.127.L	12,7	27	57,5	10x27
L105.140.R	L105.140.L	14	27	57,5	10x27
L105.150.R	L105.150.L	15	27	57,5	10x27
L106.050.R	L106.050.L	5	18	57,5	10x34
L106.060.R	L106.060.L	6	18	57,5	10x34
L106.080.R	L106.080.L	8	18	57,5	10x34
L106.100.R	L106.100.L	10	18	57,5	10x34
L107.040.R	L107.040.L	4	35	70	10x30
L107.045.R	L107.045.L	4,5	35	70	10x30
L107.050.R	L107.050.L	5	35	70	10x30
L107.060.R	L107.060.L	6	35	70	10x30
L107.064.R	L107.064.L	6,4	35	70	10x30
L107.070.R	L107.070.L	7	35	70	10x30
L107.080.R	L107.080.L	8	35	70	10x30
L107.090.R	L107.090.L	9	35	70	10x30
L107.095.R	L107.095.L	9,5	35	70	10x30
L107.100.R	L107.100.L	10	35	70	10x30
L107.110.R	L107.110.L	11	35	70	10x30
L107.120.R	L107.120.L	12	35	70	10x30
L107.127.R	L107.127.L	12,7	35	70	10x30
L107.130.R	L107.130.L	13	35	70	10x30
L107.140.R	L107.140.L	14	35	70	10x30
L107.160.R	L107.160.L	16	35	70	10x30
L108.050.R	L108.050.L	5	44	77	10X30
L108.060.R	L108.060.L	6	44	77	10X30
L108.070.R	L108.070.L	7	44	77	10X30
L108.080.R	L108.080.L	8	44	77	10X30
L108.100.R	L108.100.L	10	44	77	10X30
L108.120.R	L108.120.L	12	44	77	10X30



Z051.302.R

On request



Z051.505.R

HW DOWEL DRILLS Z=2

ART. L109

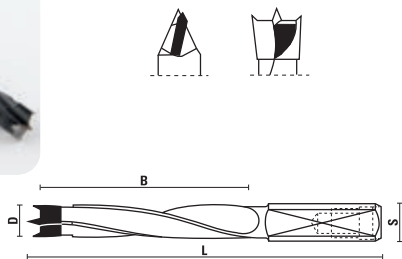

- 4-flutes
- Spurs ground with negative cutting angle for a good finish
- PTFE-Based coating for a better chip flow
- For natural wood, pressed wood, veneered, chipboard, laminated and MDF

RH rotation	LH rotation	D	B	L	S
L109.050.R	L109.050.L	5	45	85	10X30
L109.060.R	L109.060.L	6	45	85	10X30
L109.070.R	L109.070.L	7	45	85	10X30
L109.080.R	L109.080.L	8	45	85	10X30
L109.100.R	L109.100.L	10	45	85	10X30
L109.120.R	L109.120.L	12	45	85	10X30



Z051.302.R



On request

Z051.505.R

HW DOWEL DRILLS Z=2

ART. L110

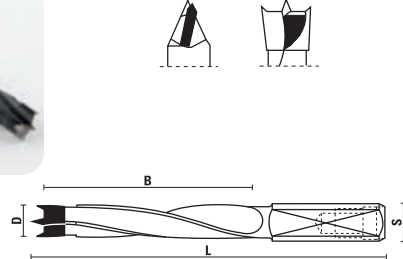

- 4-flutes
- Spurs ground with negative cutting angle for a good finish
- PTFE-Based coating for a better chip flow
- For natural wood, pressed wood, veneered, chipboard, laminated and MDF

RH rotation	LH rotation	D	B	L	S
L110.050.R	L110.050.L	5	65	105	10x30
L110.060.R	L110.060.L	6	65	105	10x30
L110.070.R	L110.070.L	7	65	105	10x30
L110.080.R	L110.080.L	8	65	105	10x30
L110.100.R	L110.100.L	10	65	105	10x30
L110.120.R	L110.120.L	12	65	105	10x30



Z051.302.R



On request

Z051.505.R

HW DOWEL DRILLS WITH 2 AND 4 FLUTES (from art. L101 to L110)

How to determine the feeding speed according to the machine (RPM):

- Referred to a standard common diameter

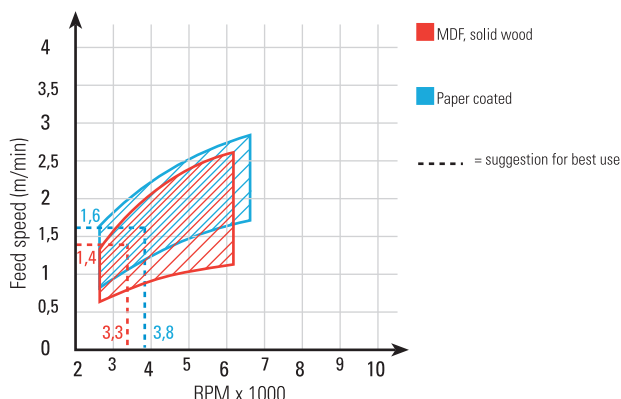
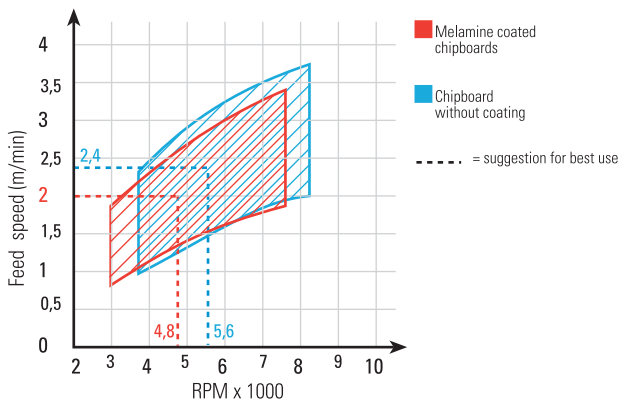

2 flutes version art. L105/L106/L107/L108

Recommended for panel machining due to less friction because of reduced tool body diameter. Countersink (art. L131) fixed on the tool shank

4 flutes version art. L101/L102/L103/L104/L109/L110

Countersink (art. L130) fixed on the tool flute

All drills (Art. L101÷L135) and hinge boring bits (Art. L140÷L142) are produced with tolerances according to instructions of Weeke Machines

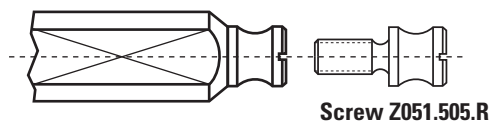

Screw Z051.505.R

HW DOWEL DRILLS EXTRA FINE Z=2

ART. L112 - L113

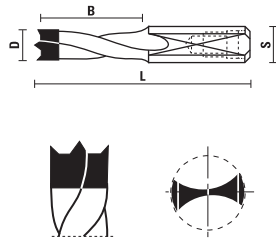

- 2-flutes
- Rounded spurs and special HW for a better finish and longer lasting tool performance
- PTFE-Based coating for a better chip flow
- For natural wood, pressed wood, veneered, chipboard, laminated and MDF

RH rotation	LH rotation	D	B	L	S
L112.050.R NEW	L112.050.L NEW	5	27	57,5	10X27
L112.060.R NEW	L112.060.L NEW	6	27	57,5	10X27
L112.064.R NEW	L112.064.L NEW	6,4	27	57,5	10X27
L112.070.R NEW	L112.070.L NEW	7	27	57,5	10X27
L112.080.R NEW	L112.080.L NEW	8	27	57,5	10X27
L112.100.R NEW	L112.100.L NEW	10	27	57,5	10X27
L112.120.R NEW	L112.120.L NEW	12	27	57,5	10x27
L113.050.R NEW	L113.050.L NEW	5	35	70	10x30
L113.060.R NEW	L113.060.L NEW	6	35	70	10x30
L113.064.R NEW	L113.064.L NEW	6,4	35	70	10x30
L113.070.R NEW	L113.070.L NEW	7	35	70	10x30
L113.080.R NEW	L113.080.L NEW	8	35	70	10x30
L113.100.R NEW	L113.100.L NEW	10	35	70	10x30
L113.120.R NEW	L113.120.L NEW	12	35	70	10x30



Z051.302.R

On request Z051.505.R

HW AND SOLID CARBIDE DOWEL DRILLS (art. L112 - L113)

How to determine the feeding speed according to the machine (RPM):

- Referred to a standard common diameter

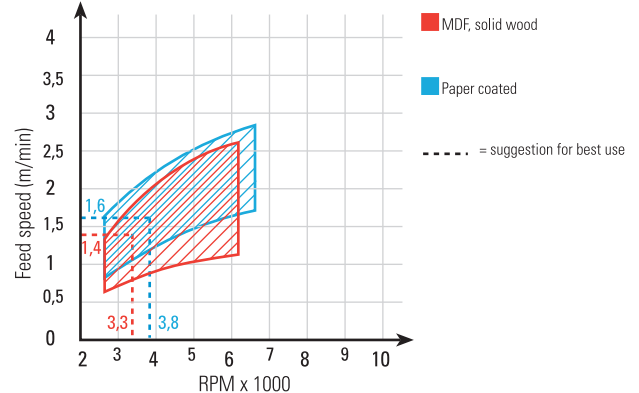
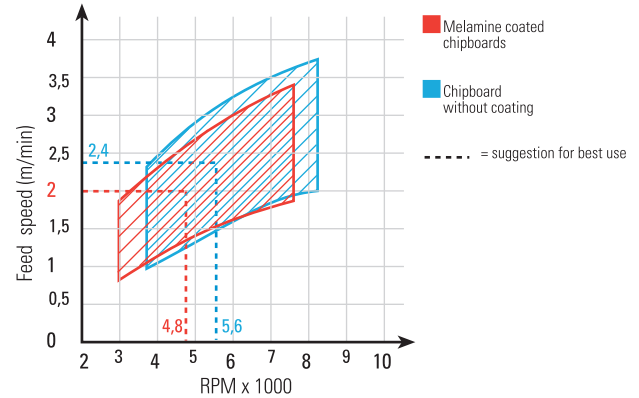

- High performance drills thanks to the special spur geometry;
- Suitable for working all materials with very good result;
- Suitable to work at higher feed speed and RPM.

SPURS GEOMETRY OF THE DOWEL DRILLS:

Negative spurs and center point
ART. L101 ÷ L110

STANDARD

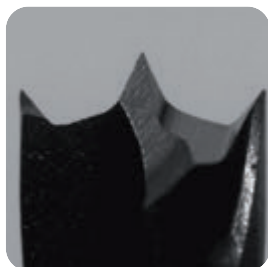

Front

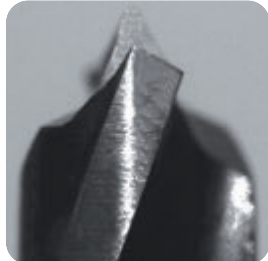

Side

- Good finish and tool life
- Lower price

Rounded spurs and center point
ART. L112 ÷ L113

EXTRA FINE

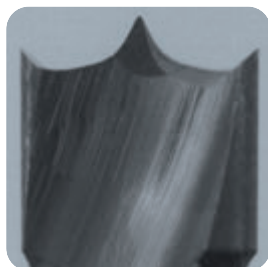

Front

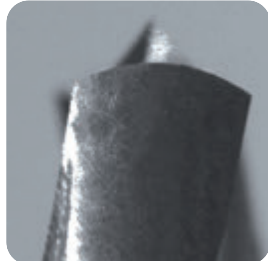

Side

- HW more resistant to wear
- Better finish
- Longer tool life

Rounded spurs and reinforced center point
ART. L114 ÷ L117

EXTRA TIME

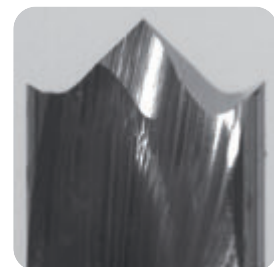

Front



Side

- HW more resistant to wear
- Excellent finish
- Longer tool life
- Easier to sharpen
- Excellent performance in any working conditions
- Best price/quality ratio

Images taken with PRE SET LEADER

HW DOWEL DRILLS EXTRA TIME Z=2

ART. L114 - L115

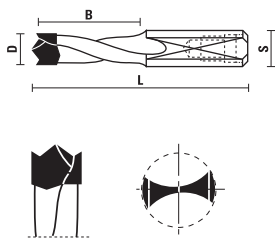

- 2-flutes
- Rounded spurs and reinforced centre point
- Special HW
- Excellent finish and longer tool life
- PTFE-Based coating for a better chip flow
- For natural wood, pressed wood, veneered, chipboard, laminated and MDF
- Suggested also for working trespa and melamine panels

RH rotation	LH rotation	D	B	L	S
L114.050.R	L114.050.L	5	27	57,5	10X27
L114.060.R	L114.060.L	6	27	57,5	10x27
L114.064.R	L114.064.L	6,4	27	57,5	10x27
L114.070.R	L114.070.L	7	27	57,5	10x27
L114.080.R	L114.080.L	8	27	57,5	10x27
L114.100.R	L114.100.L	10	27	57,5	10x27
L114.120.R	L114.120.L	12	27	57,5	10x27
L115.050.R	L115.050.L	5	35	70	10x30
L115.060.R	L115.060.L	6	35	70	10x30
L115.064.R	L115.064.L	6,4	35	70	10x30
L115.070.R	L115.070.L	7	35	70	10x30
L115.080.R	L115.080.L	8	35	70	10x30
L115.100.R	L115.100.L	10	35	70	10x30
L115.120.R	L115.120.L	12	35	70	10x30



Z051.302.R

On request



Z051.505.R

VHW DOWEL DRILLS EXTRA TIME Z=2

ART. L116 - L117

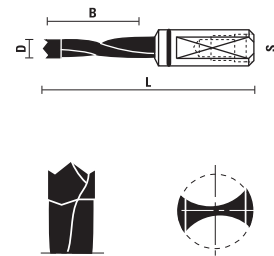

- Solid carbide spiral portion
- 2-flutes
- Rounded spurs and reinforced centre point
- Special HW
- Excellent finish and longer tool life
- For natural wood, pressed wood, veneered, chipboard, laminated and MDF
- Suggested also for working trespa and melamine panels

RH rotation	LH rotation	D	B	L	S
L116.030.R	L116.030.L	3	20	57,5	10X32
L116.040.R	L116.040.L	4	23	57,5	10X27
L116.050.R	L116.050.L	5	23	57,5	10X27
L116.060.R	L116.060.L	6	23	57,5	10X27
L116.064.R	L116.064.L	6,4	23	57,5	10X27
L116.070.R	L116.070.L	7	23	57,5	10X27
L116.080.R	L116.080.L	8	23	57,5	10X27
L117.030.R	L117.030.L	3	20	70	10x38
L117.040.R	L117.040.L	4	30	70	10x30
L117.050.R	L117.050.L	5	30	70	10x30
L117.060.R	L117.060.L	6	30	70	10x30
L117.064.R	L117.064.L	6,4	30	70	10x30
L117.070.R	L117.070.L	7	30	70	10x30
L117.080.R	L117.080.L	8	30	70	10x30



Z051.302.R



Z059.001.L



Z059.001.R

On request



Z051.505.R

HW AND SOLID CARBIDE DOWEL DRILLS (art. L114 - L115 - L116 - L117)

How to determine the feeding speed according to the machine (RPM):

- Referred to a standard common diameter

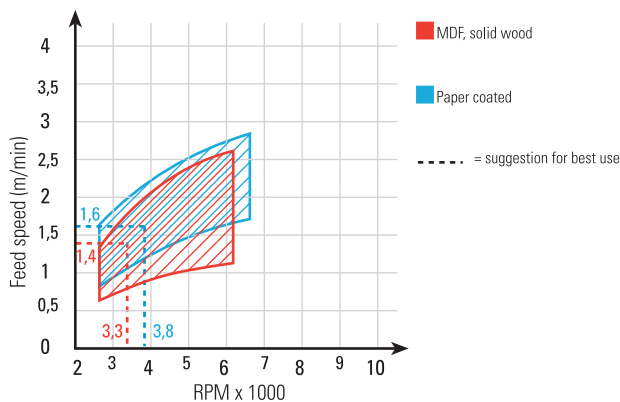
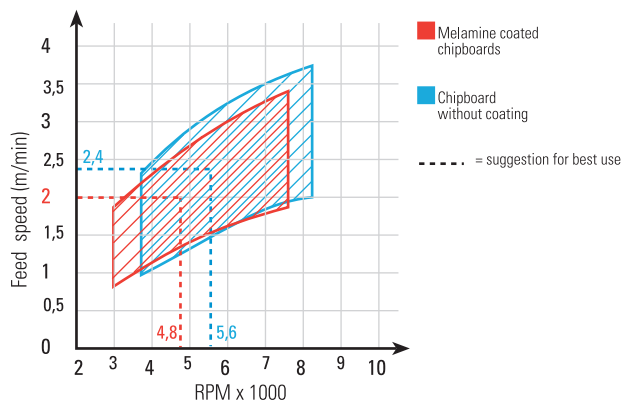

- Special spur geometry with reinforced centre point for excellent performance
- Recommended also for working problematic materials, like panels coated with paper
- Suitable to work at higher feed speed and RPM

VHW DOWEL DRILLS Z=2

ART. L118



- Solid carbide spiral portion
- 2-flutes
- For natural wood, pressed wood, veneered, chipboard, laminated and MDF
- Ideal for **Trespa**

RH rotation	LH rotation	D	B	L	S
L118.040.R	L118.040.L	4	32	70	10X30
L118.050.R	L118.050.L	5	32	70	10X30
L118.060.R	L118.060.L	6	32	70	10X30
L118.064.R	L118.064.L	6,4	32	70	10X30
L118.070.R	L118.070.L	7	32	70	10X30
L118.080.R	L118.080.L	8	32	70	10X30



Z051.302.R



Z059.001.L



Z059.001.R



On request

Z051.505.R

VHW TWIST DRILLS Z=2

ART. L120



- Solid carbide
- 2-flutes
- For natural wood, pressed wood, veneered, chipboard, laminated and MDF
- Ideal for **Trespa**
- To use with adaptor bushes Art. Z010/Z011

RH rotation	LH rotation	D	B	L
L120.020.R	L120.020.L	2	18	49
L120.025.R	L120.025.L	2,5	22	55
L120.030.R	L120.030.L	3	22	55
L120.032.R	L120.032.L	3,2	22	55
L120.035.R	L120.035.L	3,5	25	55
L120.040.R	L120.040.L	4	25	55
L120.045.R	L120.045.L	4,5	28	58
L120.050.R	L120.050.L	5	28	58
L120.060.R	L120.060.L	6	28	58

VHW TWIST DRILLS (art. L120)

How to determine the feeding speed according to the machine (RPM):

- Referred to a standard common diameter

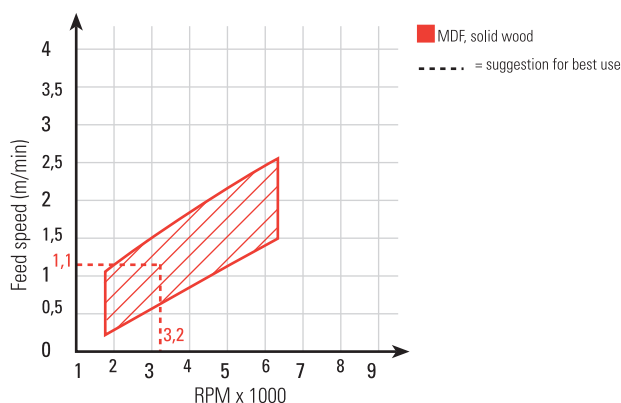
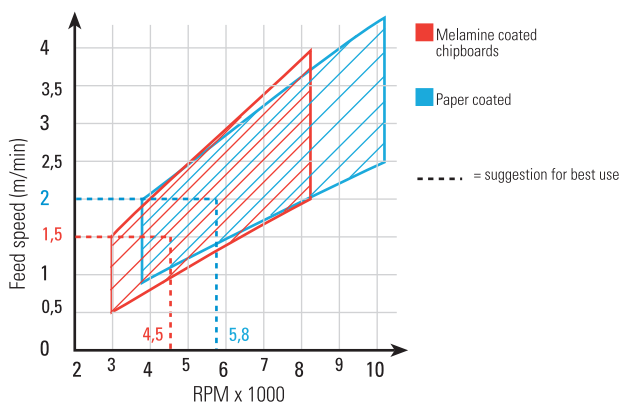

DRILL HOLDER-SLEEVES

ART. Z010

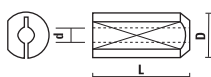

For Art. L120



Item	d	D	L
Z010.020.N	2	10	24
Z010.025.N	2,5	10	24
Z010.030.N	3	10	24
Z010.032.N	3,2	10	24
Z010.035.N	3,5	10	24
Z010.040.N	4	10	24
Z010.045.N	4,5	10	24
Z010.050.N	5	10	24
Z010.060.N	6	10	24

DRILL HOLDERS

ART. Z011

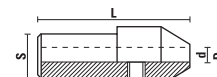

For Art. L120



Item	d	D	L	S
Z011.020.N	2	15	35	10x19
Z011.025.N	2,5	15	35	10x19
Z011.030.N	3	15	35	10x19
Z011.032.N	3,2	15	35	10x19
Z011.035.N	3,5	15	35	10x19
Z011.040.N	4	15	35	10x19
Z011.045.N	4,5	15	35	10x19
Z011.050.N	5	15	35	10x19
Z011.060.N	6	15	35	10x19

HW THROUGH HOLE DRILL BITS Z=2

ART. L123 - L124 - L125

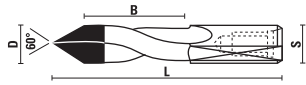

- 2-flutes
- PTFE-Based coating for a better chip flow
- For natural wood, pressed wood, veneered, chipboard, laminated and MDF

RH rotation	LH rotation	D	B	L	S
L123.040.R	L123.040.L	4	27	57,5	10X24
L123.050.R	L123.050.L	5	27	57,5	10X24
L123.060.R	L123.060.L	6	27	57,5	10X24
L123.070.R	L123.070.L	7	27	57,5	10X24
L123.080.R	L123.080.L	8	27	57,5	10X24
L123.090.R	L123.090.L	9	27	57,5	10X24
L123.100.R	L123.100.L	10	27	57,5	10X24
L124.040.R	L124.040.L	4	37	70	10X24
L124.050.R	L124.050.L	5	37	70	10X24
L124.060.R	L124.060.L	6	37	70	10X24
L124.064.R	L124.064.L	6,4	37	70	10X24
L124.070.R	L124.070.L	7	37	70	10X24
L124.080.R	L124.080.L	8	37	70	10X24
L124.090.R	L124.090.L	9	37	70	10X24
L124.095.R	L124.095.L	9,5	37	70	10X24
L124.100.R	L124.100.L	10	37	70	10X24
L124.120.R	L124.120.L	12	37	70	10X24
L125.050.R	L125.050.L	5	45	77	10X24
L125.060.R	L125.060.L	6	45	77	10X24
L125.070.R	L125.070.L	7	45	77	10X24
L125.080.R	L125.080.L	8	45	77	10X24
L125.100.R	L125.100.L	10	45	77	10X24



Z051.302.R



Z051.505.R

HW THROUGH HOLE DRILL BITS Z=2

ART. L126 - L127

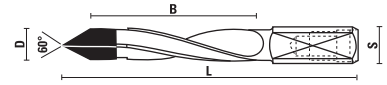

- 4-flutes
- PTFE-Based coating for a better chip flow
- For natural wood, pressed wood, veneered, chipboard, laminated and MDF

RH rotation	LH rotation	D	B	L	S
L126.050.R	L126.050.L	5	27	57,5	10X20
L126.060.R	L126.060.L	6	27	57,5	10X20
L126.080.R	L126.080.L	8	27	57,5	10X20
L127.045.R	L127.045.L	4,5	40	70	10X20
L127.050.R	L127.050.L	5	40	70	10X20
L127.055.R	L127.055.L	5,5	40	70	10X20
L127.060.R	L127.060.L	6	40	70	10X20
L127.070.R	L127.070.L	7	40	70	10X20
L127.080.R	L127.080.L	8	40	70	10X20
L127.090.R	L127.090.L	9	40	70	10X20
L127.100.R	L127.100.L	10	40	70	10X20
L127.120.R	L127.120.L	12	40	70	10X20



Z051.302.R



Z051.505.R

HW THROUGH HOLE DOWEL DRILLS WITH 2 AND 4 FLUTES (from art. L121 to L127)

How to determine the feeding speed according to the machine (RPM):

- Referred to a standard common diameter

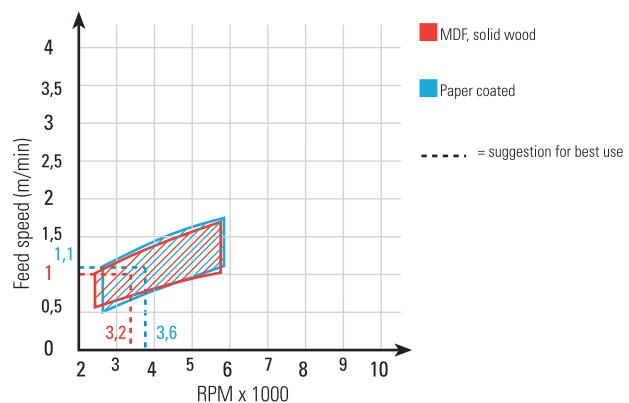
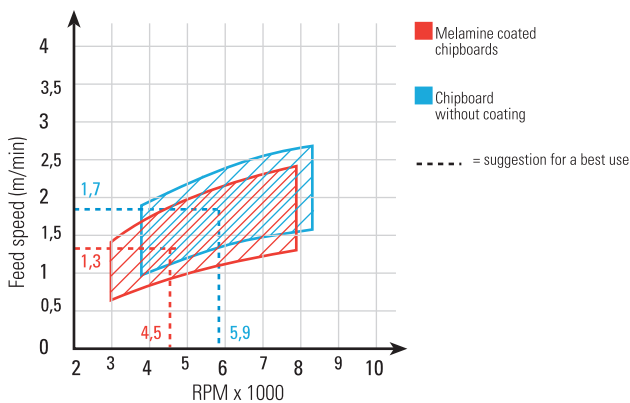

- Finish quality will be improved reducing the feed before the drill exit from the panel bottom side
- The solid carbide drills art. L129 allow the same results at higher feed speed and RPM

VHW THROUGH HOLE DRILL BITS Z=2

ART. L129

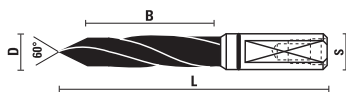

- Solid carbide spiral portion
- 2-flutes
- For natural wood, pressed wood, veneered, chipboard, laminated and MDF
- Best choice when working panels with special coating

RH rotation	LH rotation	D	B	L	S
L129.050.R	L129.050.L	5	30	70	10x30
L129.060.R	L129.060.L	6	30	70	10x30
L129.080.R	L129.080.L	8	30	70	10x30



Z051.302.R



Z059.001.L



Z059.001.R

On request



Z051.505.R

HW COUNTERSINKS Z=2 - 90°

ART. L130

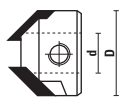

- For 4 Flutes drills:
Articles L103, L104, M101, M102, M103, M121, M122, M123, N101, N111, N135, N136
- Adjustable on the cutting length

RH rotation	LH rotation	d	D
L130.040.R	L130.040.L	4	15,5
L130.050.R	L130.050.L	5	15,5



Z051.303.R

L130.060.R	L130.060.L	6	15,5
L130.064.R	L130.064.L	6,4	15,5
L130.070.R	L130.070.L	7	18
L130.080.R	L130.080.L	8	18
L130.090.R	L130.090.L	9	18
L130.100.R	L130.100.L	10	20
L130.120.R	L130.120.L	12	22



Z051.300.R

HW COUNTERSINKS Z=2 - 90°

ART. L131

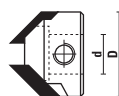

- For Articles L105, L106, L107, L108
- To be mounted on the shank \varnothing 10

RH rotation	LH rotation	d	D
L131.100.R	L131.100.L	5/10	20
L131.120.R	L131.120.L	11/12	22



Z051.304.R

VHW DOWEL DRILLS FOR BOTH RIGHT HAND AND LEFT HAND ROTATION Z=1

ART. L136 - L137

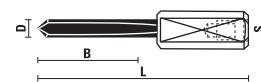

- Solid carbide spiral portion
- Straight cutting edges
- Can be used on either right and left rotation chucks
- Ideal for drilling highly **abrasive material**

Item	D	B	L	S
L136.020.N	2	12	57,5	10x33
L136.025.N	2,5	15	57,5	10x33
L136.030.N	3	16	57,5	10x30
L136.035.N	3,5	18	57,5	10x30
L136.040.N	4	20	57,5	10x30
L136.050.N	5	25	57,5	10x25
L136.060.N	6	25	57,5	10x25
L136.080.N	8	25	57,5	10x25

L137.020.N	2	12	70	10x33
L137.025.N	2,5	12	70	10x33
L137.030.N	3	24	70	10x30
L137.035.N	3,5	30	70	10x30
L137.040.N	4	32	70	10x30
L137.050.N	5	35	70	10x25
L137.060.N	6	35	70	10x25
L137.080.N	8	35	70	10x25



Z051.302.R

On request



Z051.505.R

HW DOWEL DRILLS WITH COUNTERSINK Z=2

ART. L138 - L139

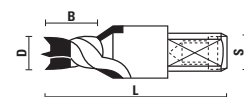

- Spurs ground with negative cutting angle for a good finish
- Cylindrical shank with flat/screw

RH rotation	LH rotation	D	B	L	S
L138.080.R	L138.080.L	8	12	57,5	10x20
L138.081.R	L138.081.L	8	15	57,5	10x20
L138.082.R	L138.082.L	8	20	57,5	10x20
L138.100.R	L138.100.L	10	12	57,5	10x20
L138.101.R	L138.101.L	10	15	57,5	10x20
L138.102.R	L138.102.L	10	20	57,5	10x20

L139.080.R	L139.080.L	8	12	70	10x20
L139.081.R	L139.081.L	8	15	70	10x20
L139.082.R	L139.082.L	8	20	70	10x20
L139.100.R	L139.100.L	10	12	70	10x20
L139.101.R	L139.101.L	10	15	70	10x20
L139.102.R	L139.102.L	10	20	70	10x20



Z051.302.R

HW THROUGH HOLE DRILL BITS "E.T." LINE Z=2

ART. L132 - L133

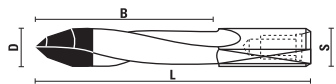

- **High performance**, double angle geometry
- PTFE-Based coating for a better chip flow
- For natural wood, pressed wood, veneered, chipboard, laminated and MDF

RH rotation	LH rotation	D	B	L	S
L132.050.R	L132.050.L	5	30	58	10x24
L132.060.R	L132.060.L	6	30	58	10x24
L132.080.R	L132.080.L	8	30	58	10x24
L133.040.R	L133.040.L	4	36	70	10x24
L133.050.R	L133.050.L	5	36	70	10x24
L133.060.R	L133.060.L	6	36	70	10x24
L133.064.R	L133.064.L	6,4	36	70	10x24
L133.070.R	L133.070.L	7	36	70	10x24
L133.080.R	L133.080.L	8	36	70	10x24
L133.100.R	L133.100.L	10	36	70	10x24
L133.120.R	L133.120.L	12	36	70	10x24



Z051.302.R



Z051.505.R

On request

VHW THROUGH HOLE DRILL BITS "E.T." LINE Z=2

ART. L134 - L135



- **Solid carbide spiral portion**
- **High performance**, double angle geometry
- For natural wood, pressed wood, veneered, chipboard, laminated and MDF

RH rotation	LH rotation	D	B	L	S
L134.050.R	L134.050.L	5	28	58	10x20
L134.060.R	L134.060.L	6	28	58	10x20
L134.080.R	L134.080.L	8	28	58	10x20
L135.040.R	L135.040.L	4	40	70	10x20
L135.050.R	L135.050.L	5	40	70	10x20
L135.060.R	L135.060.L	6	40	70	10x20
L135.064.R	L135.064.L	6,4	40	70	10x20
L135.070.R	L135.070.L	7	40	70	10x20
L135.080.R	L135.080.L	8	40	70	10x20



Z051.302.R



Z059.001.L



Z059.001.R

On request



Z051.505.R

HW AND VHW THROUGH HOLE DOWEL DRILLS "E.T." EXTRA TIME (art. L132 - L133)

How to determine the feeding speed according to the machine (RPM):

- Referred to a standard common diameter

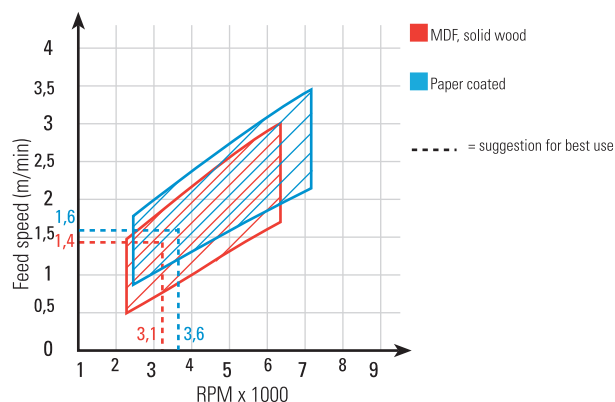
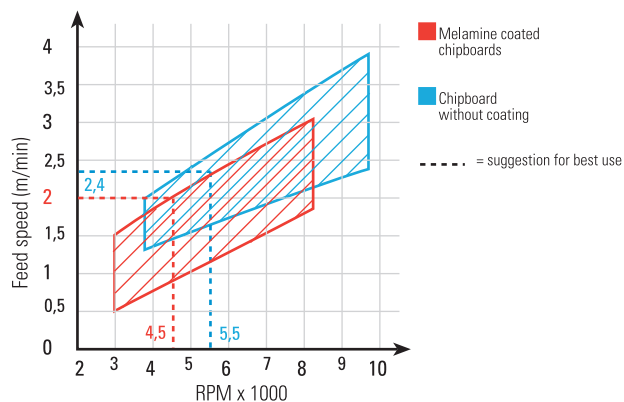

- Excellent finish result at high feed speed
- Use the solid carbide drills art. L134-L135 for the same result at higher feed speed and RPM

HW HINGE BORING BITS Z=2+2

ART. L140 - L141

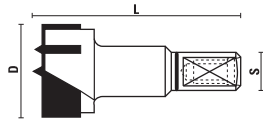

For natural and pressed woods, chipboards, veneered and laminate coated panels and MDF

RH rotation	LH rotation	D	L	S
L140.150.R	L140.150.L	15	57	10X26
L140.160.R	L140.160.L	16	57	10X26
L140.170.R	L140.170.L	17	57	10X26
L140.180.R	L140.180.L	18	57	10X26
L140.190.R	L140.190.L	19	57	10X26
L140.200.R	L140.200.L	20	57	10X26
L140.220.R	L140.220.L	22	57	10X26
L140.240.R	L140.240.L	24	57	10X26
L140.250.R	L140.250.L	25	57	10X26
L140.260.R	L140.260.L	26	57	10X26
L140.280.R	L140.280.L	28	57	10X26
L140.300.R	L140.300.L	30	57	10X26
L140.320.R	L140.320.L	32	57	10X26
L140.340.R	L140.340.L	34	57	10X26
L140.350.R	L140.350.L	35	57	10X26
L140.360.R	L140.360.L	36	57	10X26
L140.380.R	L140.380.L	38	57	10X26
L140.400.R	L140.400.L	40	57	10X26

L141.150.R	L141.150.L	15	70	10X26
L141.160.R	L141.160.L	16	70	10X26
L141.180.R	L141.180.L	18	70	10X26
L141.200.R	L141.200.L	20	70	10X26
L141.220.R	L141.220.L	22	70	10X26
L141.250.R	L141.250.L	25	70	10X26
L141.260.R	L141.260.L	26	70	10X26
L141.300.R	L141.300.L	30	70	10X26
L141.340.R	L141.340.L	34	70	10X26
L141.350.R	L141.350.L	35	70	10X26
L141.400.R	L141.400.L	40	70	10X26



HW HINGE BORING BITS Z=2+2

ART. L142

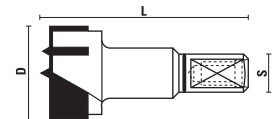

For natural and pressed woods, chipboards, veneered and laminate coated panels and MDF

RH rotation	LH rotation	D	L	S
L142.200.R	L142.200.L	20	77	10X26
L142.250.R	L142.250.L	25	77	10X26
L142.300.R	L142.300.L	30	77	10X26
L142.350.R	L142.350.L	35	77	10X26



HW HINGE BORING BITS Z=2+2

ART. L150 - L151

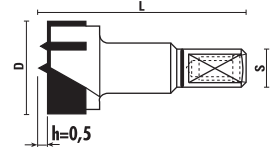

- Centerpoint H=0,5 mm for thin boards (16 mm)
- For natural and pressed woods, chipboards, veneered and laminate coated panels and MDF

RH rotation	LH rotation	D	L	S
L150.150.R	L150.150.L	15	56	10X26
L150.200.R	L150.200.L	20	56	10X26
L150.250.R	L150.250.L	25	56	10X26
L150.260.R	L150.260.L	26	56	10X26
L150.300.R	L150.300.L	30	56	10X26
L150.350.R	L150.350.L	35	56	10X26
L150.400.R	L150.400.L	40	56	10X26

L151.150.R	L151.150.L	15	70	10X26
L151.200.R NEW	L151.200.L NEW	20	70	10X26
L151.350.R NEW	L151.350.L NEW	35	70	10X26



HW HINGE BORING BITS Z=2+2 (ART. L140-L141-L142-L150-L151)

How to determine the feeding speed according to the machine (RPM):

- Referred to a standard common diameter

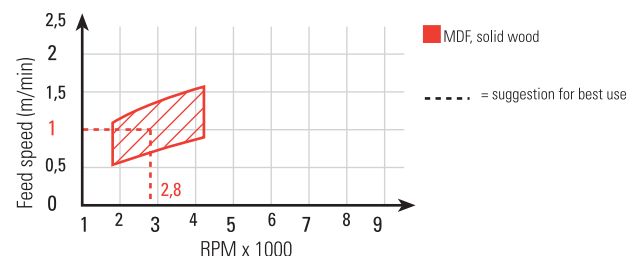
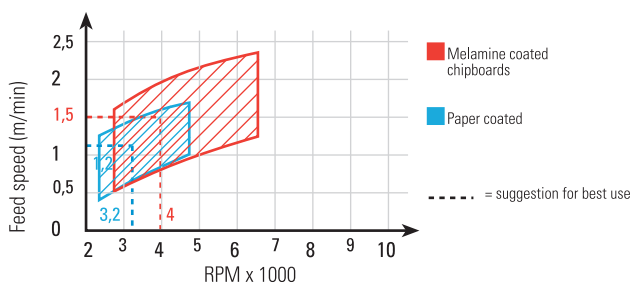

HW HINGE BORING BITS Z=3+3

ART. L143 - L144

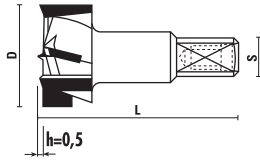

Centerpoint H=0,5 mm

RH rotation	LH rotation	D	L	S
L143.250.R	L143.250.L	25	57,5	10x26
L143.260.R	L143.260.L	26	57,5	10x26
L143.300.R	L143.300.L	30	57,5	10x26
L143.350.R	L143.350.L	35	57,5	10x26
L143.400.R	L143.400.L	40	57,5	10x26



Z051.302.R



Without centerpoint

RH rotation	LH rotation	D	L	S
L144.250.R	L144.250.L	25	57,5	10x26
L144.260.R	L144.260.L	26	57,5	10x26
L144.300.R	L144.300.L	30	57,5	10x26
L144.350.R	L144.350.L	35	57,5	10x26



Z051.302.R

HW HINGE BORING BITS Z=3+3 (art. L143-L144)

How to determine the feeding speed according to the machine (RPM):

- Referred to a standard common diameter

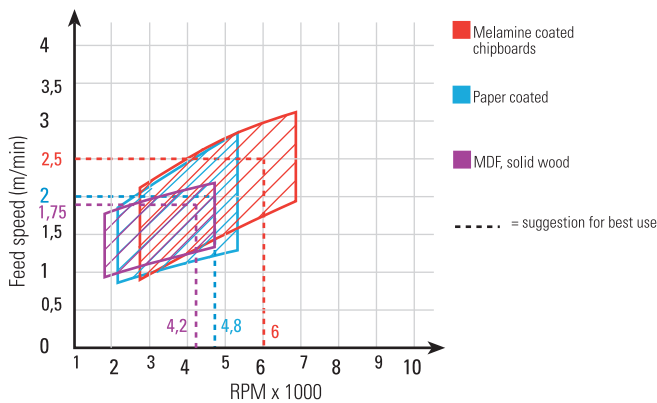

VHW HINGE BORING BITS Z=2+2

ART. L155 - L156

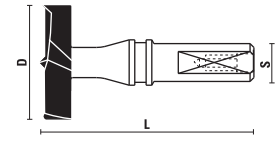

- Solid carbide
- Rounded spurs for an **excellente finish**
- **Highest performance** also in extreme conditions
- For high precision bores for hinges
- Ideal for **hard and soft wood, chipboard, MDF, veneered and plastic coated boards**

RH rotation	LH rotation	D	L	S
L155.150.R NEW	L155.150.L NEW	15	57	10x26
L155.200.R NEW	L155.200.L NEW	20	57	10x26
L155.250.R NEW	L155.250.L NEW	25	57	10x26
L155.300.R NEW	L155.300.L NEW	30	57	10x26
L155.350.R NEW	L155.350.L NEW	35	57	10x26

L156.150.R NEW	L156.150.L NEW	15	70	10x26
L156.200.R NEW	L156.200.L NEW	20	70	10x26
L156.250.R NEW	L156.250.L NEW	25	70	10x26
L156.300.R NEW	L156.300.L NEW	30	70	10x26
L156.350.R NEW	L156.350.L NEW	35	70	10x26



Z051.302.R

VHW HINGE BORING BITS Z=2+2 (art. L155-L156)

How to determine the feeding speed according to the machine (RPM):

- Referred to a standard common diameter

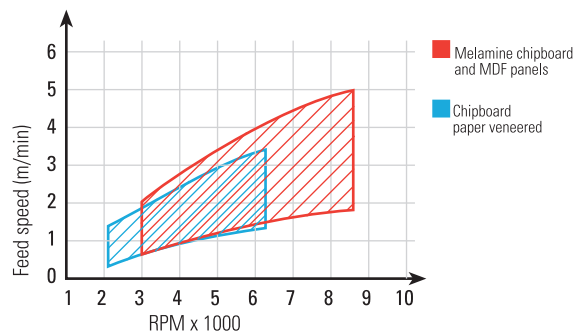

HW HINGE BORING BITS Z=2+2

ART. L160

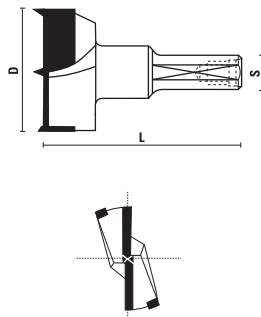

To be used on Trimatic 22-25-28

RH rotation	LH rotation	D	L	S
L160.300.R NEW	L160.300.L NEW	30	57	10X26
L160.340.R	L160.340.L	34	57	10X26



Z051.302.R

HW HINGE BORING BITS Z=2+2

ART. L170

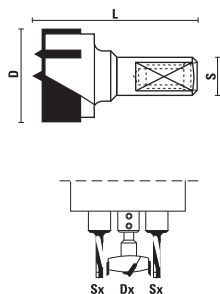

To be used on Trimatic Super

RH rotation	LH rotation	D	L	S
L170.200.R NEW	L170.200.L NEW	20	38,5	10X22
L170.260.R		26	38,5	10X22
L170.350.R	L170.350.L	35	38,5	10X22
L170.400.R		40	38,5	10X22



Z051.302.R

HW DOWEL DRILLS Z=2

ART. L171

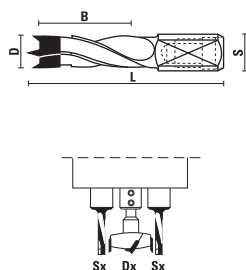

- To be used on Trimatic Super
- PTFE-Based coating for a better chip flow
- For natural and pressed woods, chipboards and laminate coated panels

RH rotation	LH rotation	D	B	L	S
L171.050.R NEW	L171.050.L	5	18	38,5	10X18
L171.080.R	L171.080.L	8	18	38,5	10X18
L171.100.R	L171.100.L	10	18	38,5	10X18



Z051.302.R

TRIMATIC 22 - 25 - 28 SPECIAL DEVICES FOR ANGULAR HINGES INSERTING

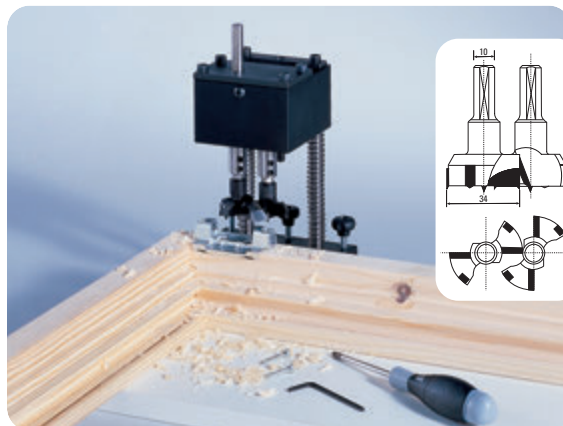

Fixing of edge hinge

Item

TRIMATIC 22
for angular hinges "Siegenia" with a distance between centres of 22 mm

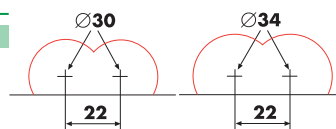

Item

TRIMATIC 25
for angular hinges "Gu" with a distance between centres of 25 mm

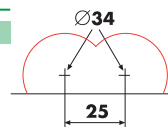

Item

TRIMATIC 28
for angular hinges "Trend" and AGB with a distance between centres of 28 mm

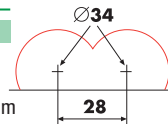

See catalogue section 16 at page 16.10

Drilling jig for making holes for hinge inserting

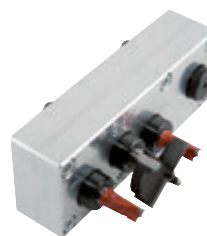

See catalogue section 16 at page 16.12

HW DOWEL DRILLS WITH THREADED SHANK Z=2

ART. M101 - M102 - M103

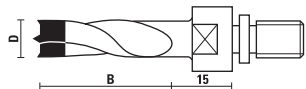

- 4-flutes
- M10/11x4 for: MORBIDELLI - BIESSE - WEEKE

RH rotation	LH rotation	D	B
M101.050.R	M101.050.L	5	30
M101.060.R	M101.060.L	6	30
M101.080.R	M101.080.L	8	30
M101.100.R	M101.100.L	10	30
M101.120.R	M101.120.L	12	30
M101.140.R	M101.140.L	14	30
M102.050.R	M102.050.L	5	40
M102.060.R	M102.060.L	6	40
M102.080.R	M102.080.L	8	40
M102.100.R	M102.100.L	10	40
M102.120.R	M102.120.L	12	40
M102.140.R	M102.140.L	14	40
M103.050.R	M103.050.L	5	50
M103.060.R	M103.060.L	6	50
M103.080.R	M103.080.L	8	50
M103.100.R	M103.100.L	10	50
M103.120.R	M103.120.L	12	50
M103.140.R	M103.140.L	14	50

HW DOWEL DRILLS WITH COUNTERSINK THREADED SHANK Z=2

ART. M111 - M112 - M113

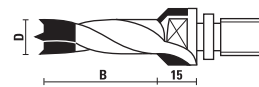

- 2-flutes
- M10/11x4 for: MORBIDELLI - BIESSE - WEEKE

RH rotation	LH rotation	D	B
M111.050.R	M111.050.L	5	30
M111.060.R	M111.060.L	6	30
M111.080.R	M111.080.L	8	30
M111.100.R	M111.100.L	10	30
M111.120.R	M111.120.L	12	30
M111.140.R	M111.140.L	14	30
M111.160.R	M111.160.L	16	30
M112.050.R	M112.050.L	5	40
M112.060.R	M112.060.L	6	40
M112.080.R	M112.080.L	8	40
M112.100.R	M112.100.L	10	40
M112.120.R	M112.120.L	12	40
M112.140.R	M112.140.L	14	40
M112.160.R	M112.160.L	16	40
M113.050.R	M113.050.L	5	50
M113.060.R	M113.060.L	6	50
M113.080.R	M113.080.L	8	50
M113.100.R	M113.100.L	10	50
M113.120.R	M113.120.L	12	50
M113.140.R	M113.140.L	14	50
M113.160.R	M113.160.L	16	50

HW DOWEL DRILLS WITH THREADED SHANK Z=2

ART. M121 - M122 - M123

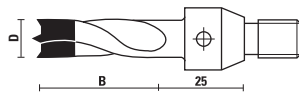

- 4-flutes
- M10/30° for: VITAP - BUSELLATO - SCHLEICHER

RH rotation	LH rotation	D	B
M121.050.R	M121.050.L	5	30
M121.060.R	M121.060.L	6	30
M121.080.R	M121.080.L	8	30
M121.100.R	M121.100.L	10	30
M121.120.R	M121.120.L	12	30
M121.140.R	M121.140.L	14	30
M122.050.R	M122.050.L	5	40
M122.060.R	M122.060.L	6	40
M122.080.R	M122.080.L	8	40
M122.100.R	M122.100.L	10	40
M122.120.R	M122.120.L	12	40
M122.140.R	M122.140.L	14	40
M123.050.R	M123.050.L	5	50
M123.060.R	M123.060.L	6	50
M123.080.R	M123.080.L	8	50
M123.100.R	M123.100.L	10	50
M123.120.R	M123.120.L	12	50
M123.140.R	M123.140.L	14	50

HW DOWEL DRILLS WITH COUNTERSINK THREADED SHANK Z=2

ART. M131 - M132 - M133

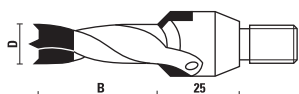

- 2-flutes
- M10/30° for: VITAP - BUSELLATO - SCHLEICHER

RH rotation	LH rotation	D	B
M131.050.R	M131.050.L	5	30
M131.060.R	M131.060.L	6	30
M131.080.R	M131.080.L	8	30
M131.100.R	M131.100.L	10	30
M131.120.R	M131.120.L	12	30
M131.140.R	M131.140.L	14	30
M131.160.R	M131.160.L	16	30
M132.050.R	M132.050.L	5	40
M132.060.R	M132.060.L	6	40
M132.080.R	M132.080.L	8	40
M132.100.R	M132.100.L	10	40
M132.120.R	M132.120.L	12	40
M132.140.R	M132.140.L	14	40
M132.160.R	M132.160.L	16	40

HW HINGE BORING BITS WITH THREADED SHANK Z=2

ART. M141 - M142

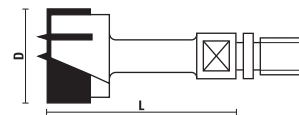

M10/11x4 for: MORBIDELLI - BIESSE - WEEKE

RH rotation	LH rotation	D	L
M141.200.R	M141.200.L	20	40
M141.250.R	M141.250.L	25	40
M141.350.R	M141.350.L	35	40
M141.400.R	M141.400.L	40	40
M142.200.R	M142.200.L	20	55
M142.250.R	M142.250.L	25	55
M142.260.R	M142.260.L	26	55
M142.300.R	M142.300.L	30	55
M142.350.R	M142.350.L	35	55
M142.400.R	M142.400.L	40	55

HW HINGE BORING BITS WITH THREADED SHANK Z=2+2

ART. M151

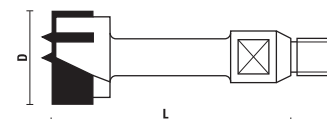

M10/30° for: VITAP - BUSELLATO - SCHLEICHER

RH rotation	LH rotation	D	L
M151.250.R	M151.250.L	25	65
M151.260.R	M151.260.L	26	65
M151.350.R	M151.350.L	35	65
M151.400.R	M151.400.L	40	65

HW HINGE BORING BITS WITH THREADED SHANK Z=2+2

ART. N121 - N131



M8 for: NOTTMAYER - M10 for: AYEN

RH rotation	LH rotation	D	L	S
N121.250.R	N121.250.L	25	63	M8
N121.350.R	N121.350.L	35	63	M8
N131.200.R	N131.200.L	20	63	M10
N131.250.R	N131.250.L	25	63	M10
N131.350.R	N131.350.L	35	63	M10

HW DOWEL DRILLS WITH THREADED SHANK Z=2

ART. N101 - N102

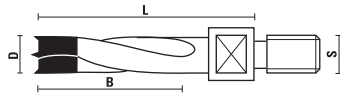

- 4-flutes
- M8 for: **NOTTMEYER** - M10 for: **AYEN**

RH rotation	LH rotation	D	B	L	S
N101.050.R	N101.050.L	5	43	63	M8
N101.060.R	N101.060.L	6	43	63	M8
N101.080.R	N101.080.L	8	43	63	M8
N101.100.R	N101.100.L	10	43	63	M8
N101.120.R	N101.120.L	12	43	63	M8
N111.050.R	N111.050.L	5	43	63	M10
N111.060.R	N111.060.L	6	43	63	M10
N111.080.R	N111.080.L	8	43	63	M10
N111.100.R	N111.100.L	10	43	63	M10
N111.120.R	N111.120.L	12	43	63	M10

HW DOWEL DRILLS WITH THREADED SHANK Z=2

ART. N135 - N136

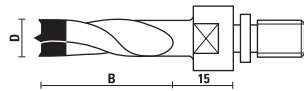

- 4-flutes
- M8/9x4 for: **MORBIDELLI, NOTTMEYER, MASTERWOOD**

RH rotation	LH rotation	D	B
N135.050.R	N135.050.L	5	40
N135.060.R	N135.060.L	6	40
N135.080.R	N135.080.L	8	40
N135.100.R	N135.100.L	10	40
N135.120.R	N135.120.L	12	40
N136.050.R	N136.050.L	5	60
N136.060.R	N136.060.L	6	60
N136.080.R	N136.080.L	8	60
N136.100.R	N136.100.L	10	60
N136.120.R	N136.120.L	12	60

HW/HS COUNTERBORE BITS

ART. N150 - N250

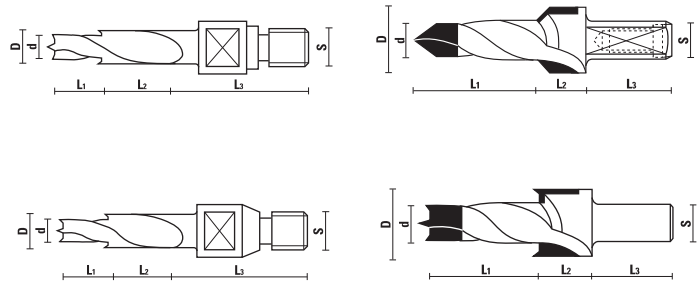

Features requested: dxL1 - DxL2 - SxL3

RH rotation	LH rotation	D	B
N150.000.R	N150.000.L	10	HW
N150.000.R	N150.000.L	12	HW
N150.000.R	N150.000.L	15	HW
N150.000.R	N150.000.L	20	HW
N150.000.R	N150.000.L	25	HW
N150.000.R	N150.000.L	30	HW
N150.000.R	N150.000.L	35	HW
N150.000.R	N150.000.L	40	HW
N250.000.R	N250.000.L	10	HS
N250.000.R	N250.000.L	12	HS
N250.000.R	N250.000.L	15	HS
N250.000.R	N250.000.L	20	HS
N250.000.R	N250.000.L	25	HS
N250.000.R	N250.000.L	30	HS
N250.000.R	N250.000.L	35	HS
N250.000.R	N250.000.L	40	HS

MODULAR DRAWER UNIT

Drawer unit

“Elegant, sturdy **Klein** drawer unit with an innovative, modern design and great modularity, where you can keep all your **Klein** tools in a clean, secure, well-organized place. Say good-bye to messiness and damaged tools. Now, with the new **Klein** drawer unit, you can put your storeroom in order in a convenient, functional way.



SMALL OUTSIDE BUT LARGE INSIDE
the **Klein** drawer unit takes up little space but can contain countless articles in its 10 drawers and 80 containers (8 containers per drawer).

- **STURDY**
since each drawer can hold around 8 kg.
- **LIGHT**
since it's made of a high-strength polypropylene co-polymer.
- **SECURE**
since each drawer has its own key.
- **PRACTICAL**
since it can be equipped with 4 casters for convenient movement or with slip-resistant feet.
- **CONVENIENT**
since it features a wooden top which acts as a practical surface for taking notes or keeping tools.
- **VERSATILE**
since the tubs in the drawers can be removed easily as desired.

Whether it's placed next to a **CNC router**, or close to a **point-to-point boring machine**, along the **panel production line** or in any **carpentry shop**, the new **Klein** drawer unit can be a real help in keeping the tools you use every day in perfect order and in good condition.



The new **Klein** drawer unit can hold a wide range of tools.
Ask our customer service how to receive it.

Modular drawer unit "Boring Machine"

Ideal to store dowel drills and boring bits beside your boring machine



1st Drawer

Drill holders

- Art. L001.100.R
- L001.100.L
- L002.100.R
- L002.100.L
- L030.100.R
- L030.100.L
- L031.100.R
- L032.100.R

2nd Drawer

Drills L=57,5

- Art. L103.040.R
- L103.040.L
- L103.050.R
- L103.050.L
- L103.060.R
- L103.060.L
- L103.070.R
- L103.070.L

3rd Drawer

Drills L=57,5

- Art. L103.080.R
- L103.080.L
- L103.100.R
- L103.100.L
- L103.120.R
- L103.120.L
- L103.140.R
- L103.140.L

4th Drawer

Drills L=70

- Art. L104.040.R
- L104.040.L
- L104.050.R
- L104.050.L
- L104.060.R
- L104.060.L
- L104.070.R
- L104.070.L

5th Drawer

Drills L=70

- Art. L104.080.R
- L104.080.L
- L104.100.R
- L104.100.L
- L104.120.R
- L104.120.L
- L104.140.R
- L104.140.L

6th Drawer

Through hole drills

- Art. L124.050.R
- L124.050.L
- L124.060.R
- L124.060.L
- L124.080.R
- L124.080.L
- L124.100.R
- L124.100.L

7th Drawer

Hinge boring bits

- Art. L140.150.R
- L140.150.L
- L140.180.R
- L140.180.L
- L140.200.R
- L140.200.L
- L140.250.R
- L140.250.L

8th Drawer

Hinge boring bits

- Art. L140.260.R
- L140.260.L
- L140.300.R
- L140.300.L
- L140.350.R
- L140.350.L
- L140.400.R
- L140.400.L

9th Drawer

High performance drills L=57,5

- Art. L114.050.R
- L114.050.L
- L114.060.R
- L114.060.L
- L114.080.R
- L114.080.L
- L114.100.R
- L114.100.L

10th Drawer

High performance drills L=70

- Art. L115.050.R
- L115.050.L
- L115.060.R
- L115.060.L
- L115.080.R
- L115.080.L
- L115.100.R
- L115.100.L

Borin bits, slot mortising bits



6



HW FLAT COUNTERSINKS Z=2
Page 6.03



HW SPIRAL BITS Z=2
Page 6.03



HW COUNTERSINK Z=2 - 30°
Page 6.03



HW SPIRAL BITS Z=2
Page 6.03



HS COUNTERSINKS Z=2
Page 6.03



HS BRAD POINT DRILLS Z=2
Page 6.04



SP BRAD POINT DRILLS Z=2
Page 6.04

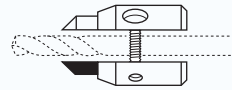

HW ADJUSTABLE COUNTERSINK
Ø 3 TO Ø 7 Z=2
Page 6.04



SP BRAD POINT DRILLS Z=2
Page 6.04



SP SINGLE FLUTE DRILLS "LEWIS"
TYPE Z=1
Page 6.05



HS SPIRAL BITS Z=2
Page 6.05



HS SPIRAL BITS Z=2
Page 6.05



HS STEP DRILLS Z=2
Page 6.05



HS STEP DRILLS Z=2
Page 6.06



HW/HS 3-DIAMETER BITS
"CONFIRMAT" Z=2
Page 6.06



3-DIAMETER HW DRILLS,
ADJUSTABLE Z=2
Page 6.06



HS TWIST DRILLS Z=2
Page 6.06



HW ADJUSTABLE DIAMETER
BORING BITS 30/60 MM
Page 6.07

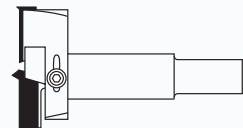

HW ADJUSTABLE DIAMETER BORING
BITS 60/80 MM
Page 6.07

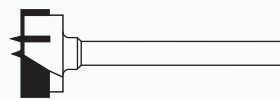

HW HINGE BORING BITS Z=2+2
Page 6.07

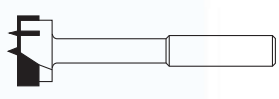

HW HINGE BORING BITS Z=2+2
Page 6.08

Klein®



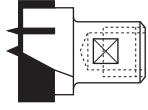

HW INTERCHANGEABLE HINGE BORING BITS Z=2+2
Page 6.08

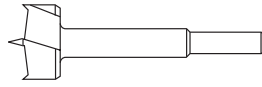

HS HINGE BORING BITS Z=2+2
Page 6.09

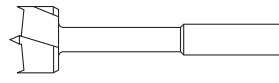

HS HINGE BORING BITS Z=2+2
Page 6.09



SP "FORSTNER" BITS Z=2+2
Page 6.09

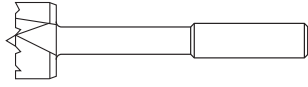

SP "FORSTNER" BITS Z=2+2
Page 6.10

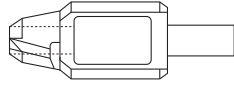

SP PLUG CUTTERS Z=2
Page 6.10

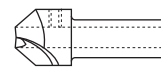

HW/HS COUNTERSINKS Z=2
Page 6.10

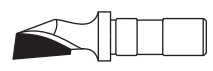

HW/HS DOVETAIL BITS 9° - Z=1
Page 6.10



VHW DOVETAIL BITS Z=2
Page 6.11

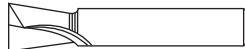

HW/HS DOVETAIL BITS Z=2
Page 6.11

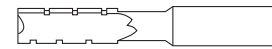

SP SLOT MORTISING BITS WITH CHIPBREAKER Z=2
Page 6.11



HL RECIPROCATING SLOT MORTISING BITS
Page 6.12

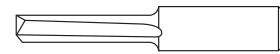

HL RECIPROCATING SLOT MORTISING BITS Z=3
Page 6.12



HW RECIPROCATING SLOT MORTISING BITS
Page 6.12



HW/KS GROOVING CUTTERS Z=2
Page 6.12



HW/KS SLOT MORTISING CUTTERS Z=2
Page 6.13

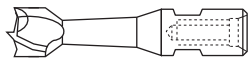

HW/KS BORING BITS Z=2
Page 6.13

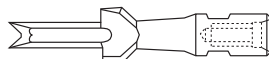

HW/KS SLOT BORING BITS Z=2
Page 6.13

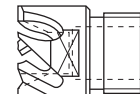

HS DOWEL CUTTERS
Page 6.13



HW HOLE SAWS
Page 6.14

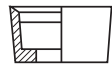

HS CUTTERS FOR COPYING LATHES
Page 6.15

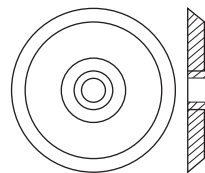

HS CUTTERS FOR COPYING LATHES
Page 6.15

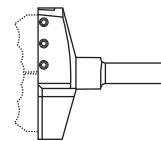

ROUTER BITS FOR DECORATIVE ROSETTES Z=2
Page 6.15



MODULAR DRAWER UNIT
Page 6.16

HW FLAT COUNTERSINKS Z=2

ART. R100

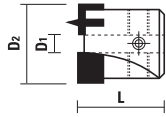

- Use with Art. R101 and with T.C.T. dowel drills Art. L103 - L104 - L109 - L110 and with all dowel drills with 4 flutes

RH rotation	LH rotation	D1	D2	L
R100.050.R	R100.050.L	5	16	20
R100.060.R	R100.060.L	6	16	20
R100.061.R	R100.061.L	6	20	20
R100.070.R	R100.070.L	7	20	20
R100.080.R	R100.080.L	8	16	20
R100.081.R	R100.081.L	8	19	20
R100.082.R	R100.082.L	8	20	20
R100.090.R	R100.090.L	9	19	20
R100.091.R	R100.091.L	9	20	20
R100.100.R	R100.100.L	10	20	20
R100.101.R	R100.101.L	10	25	20
R100.102.R	R100.102.L	10	30	20
R100.120.R	R100.120.L	12	25	20
R100.121.R	R100.121.L	12	30	20

HW SPIRAL BITS Z=2

ART. R101

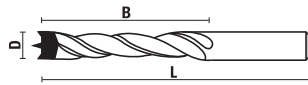

- 4-flutes
- Use rings Art. Z003 a page 10.03

RH rotation	D	B	L
R101.050.R	5	50	85
R101.060.R	6	55	90
R101.070.R	7	65	105
R101.080.R	8	75	115
R101.090.R	9	80	125
R101.100.R	10	90	135
R101.120.R	12	100	150

HW COUNTERSINKS Z=2 - 30°

ART. R102



- Use with T.C.T. dowel drills Art. L103 - L104 - L109 - L110 and with all dowel drills with 4 flutes

RH rotation	LH Rotation	D1	D2	α
R102.080.R NEW	R102.080.L NEW	8	19	30°

HW SPIRAL BITS Z=2

ART. R125



- 4-flutes
- Use rings Art. Z003 page 10.03

RH rotation	D	B	L	S
R125.060.R	6	75	140	13x50
R125.080.R	8	85	150	13x50
R125.100.R	10	95	160	13x50
R125.120.R	12	105	170	13x50
R125.130.R	13	110	175	13x50
R125.140.R	14	115	180	13x50
R125.150.R	15	120	185	13x50
R125.160.R	16	125	190	16x50
R125.180.R	18	130	200	16x50
R125.200.R	20	140	210	16x50

HS COUNTERSINKS Z=2

ART. R200

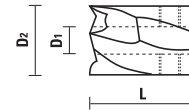

For Art. R201

RH rotation	D1	D2	L
R200.040.R	4	10	22
R200.050.R	5	12	22
R200.051.R	5	15	22
R200.060.R	6	15	22
R200.061.R	6	16	22
R200.062.R	6	20	22
R200.080.R	8	16	22
R200.081.R	8	20	22
R200.082.R	8	22	22
R200.083.R	8	25	22
R200.100.R	10	20	22
R200.101.R	10	25	25
R200.102.R	10	30	25
R200.120.R	12	25	25
R200.121.R	12	30	25

R200.910.R Set with 6 countersinks \varnothing 5/15 - 6/15 - 6/20 - 8/20 - 8/25 - 10/25 + 4 brad point drills \varnothing 5 - 6 - 8 - 10



HS BRAD POINT DRILLS Z=2

ART. R201

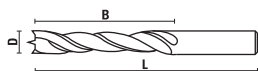

- 4-flutes
- Use rings Art. Z003 page 10.03

RH rotation	D	B	L
R201.060.R	6	55	95
R201.065.R	6,5	65	105
R201.070.R	7	70	110
R201.075.R	7,5	70	115
R201.080.R	8	75	120
R201.090.R	9	80	130
R201.100.R	10	90	140
R201.110.R	11	95	150
R201.120.R	12	100	155

SP BRAD POINT DRILLS Z=2

ART. R205



2-flutes

RH rotation	D	B	L	S
R205.030.R	3	33	60	3
R205.040.R	4	43	75	4
R205.050.R	5	52	85	5
R205.060.R	6	57	93	6
R205.070.R	7	69	109	7
R205.080.R	8	75	117	8
R205.090.R	9	81	125	9
R205.100.R	10	87	133	10
R205.111.R	11	94	150	10
R205.120.R	12	101	155	10
R205.130.R	13	101	155	10
R205.140.R	14	108	170	10
R205.150.R	15	114	170	10
R205.160.R	16	120	180	10
R205.180.R	18	130	200	10
R205.200.R	20	130	200	10
R205.220.R	22	140	210	13
R205.240.R	24	140	215	13
R205.260.R	26	140	215	13
R205.280.R	28	140	220	13
R205.300.R	30	140	220	13

R205.505.R 5 drills set \varnothing 4 -5 -6 -8 -10
R205.508.R 8 drills set \varnothing 3 -4 -5 -6 -7 -8 -9 -10

HW ADJUSTABLE COUNTERSINKS \varnothing 3 TO \varnothing 7 Z=2

ART. A199

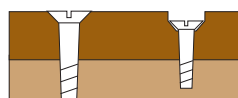
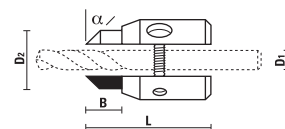

- Spare key supplied; single packed

Item	D1	D2	α	B	L
A199.030.R	3/7	11/15	45°	12	32



Insert the tool



Adjust the boring depth

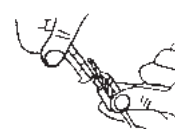

Line up the cutting edges of countersink and tool

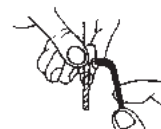

Tighten the screws



On request display free of charge by min order 10 pcs.

SP BRAD POINT DRILLS Z=2

ART. R206



- 2-flutes
- For wall brackets, girders

RH rotation	D	B	L	S
R206.080.R	8	160	245	8
R206.090.R	9	160	245	9
R206.100.R	10	160	245	10
R206.120.R	12	160	245	10
R206.121.R	12	250	400	10
R206.140.R	14	160	245	10
R206.141.R	14	250	400	10
R206.160.R	16	160	245	10
R206.161.R	16	250	400	10
R206.180.R	18	160	245	10
R206.181.R	18	250	400	10
R206.200.R	20	160	245	10
R206.201.R	20	250	400	10

SP SINGLE FLUTE DRILLS "LEWIS" TYPE Z=1

ART. R207

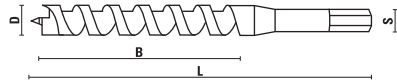

Hex shank

RH rotation	D	B	L	S
R207.080.R	8	220	300	8
R207.100.R	10	220	300	10
R207.120.R	12	220	300	10
R207.140.R	14	220	300	10
R207.150.R	15	220	300	10
R207.160.R	16	220	300	10
R207.180.R	18	220	300	13
R207.200.R	20	220	300	13
R207.220.R	22	220	300	13
R207.240.R	24	220	300	13
R207.250.R	25	220	300	13
R207.260.R	26	220	300	13
R207.280.R	28	220	300	13
R207.300.R	30	220	300	13

HS SPIRAL BITS Z=2

ART. R225

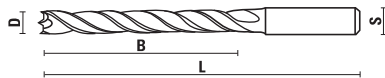

4-flutes

RH rotation	D	B	L	S
R225.060.R	6	75	140	13x50
R225.080.R	8	85	150	13x50
R225.100.R	10	95	160	13x50
R225.120.R	12	105	170	13x50
R225.130.R	13	110	175	13x50
R225.140.R	14	115	180	13x50
R225.160.R	16	125	190	16x50
R225.180.R	18	130	200	16x50
R225.200.R	20	140	210	16x50
R225.220.R	22	150	220	16x50
R225.240.R	24	160	235	16x50
R225.250.R	25	170	250	20x50
R225.300.R	30	190	270	20x50

HS SPIRAL BITS Z=2

ART. R226

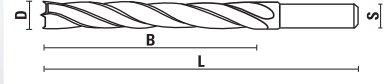

4-flutes

RH rotation	D	B	L	S
R226.110.R	11	100	140	10x30
R226.120.R	12	100	140	10x30
R226.130.R	13	100	140	10x30
R226.140.R	14	100	140	10x30
R226.150.R	15	100	140	10x30
R226.160.R	16	100	140	10x30
R226.180.R	18	100	140	10x30
R226.200.R	20	100	140	10x30

HS STEP DRILLS Z=2

ART. R202

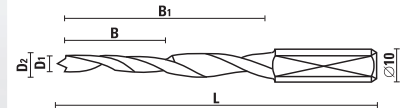

- Flat on the shank
- For **Masterwood** machines

RH rotation	D1	D2	B	B1	L	Anuba
R202.090.R	3,8	5	20	40	75	9
R202.110.R	4,2	5,7	20	45	80	11
R202.130.R	5,2	6,5	15	50	85	13
R202.140.R	5,5	7	15	55	90	14
R202.160.R	6	7,7	15	60	95	16
R202.180.R	6,6	8,2	20	70	105	18
R202.200.R	7,2	8,7	20	80	115	20



HS STEP DRILLS Z=2

ART. R203

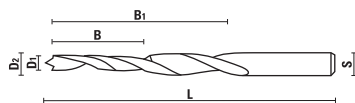

Shank throughout cylindrical

RH rotation	D1	D2	B	B1	L	S	Anuba
R203.130.R	5,4	6,5	20	50	80	6,5	13
R203.131.R	5,7	6,75	20	65	105	6,75	13
R203.140.R	6	7	20	50	80	7	14
R203.141.R	6,25	7,25	25	60	90	7,25	14
R203.142.R	6,25	7,25	20	65	105	7,25	14
R203.160.R	6,5	7,75	25	60	90	7,75	16
R203.161.R	6,5	7,75	20	70	110	7,75	16
R203.180.R	6,7	8,5	25	60	90	8,5	18
R203.181.R	6,7	8,5	25	70	110	8,5	18

HW/HS 3-DIAMETER BITS "CONFIRMAT" Z=2

ART. R104 - R204

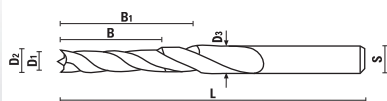

- For "Confirmat" joints
 - R104 = HW
 - R204 = HS

RH rotation	D1	D2	D3	B	B1	L	Mat.	S
R104.100.R	5,5	7,3	10	35	56	138	HW	10x50
R204.100.R	5,5	7,3	10	35	56	138	HS	10x50
R204.101.R	5,5	7,3	10	40	60	120	HS	10x40

3-DIAMETER HW DRILLS, ADJUSTABLE Z=2

ART. R108

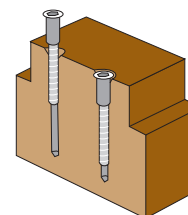
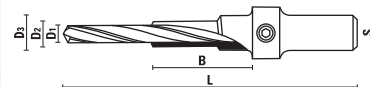

- For mounting joints screws
 - HS spare drills

RH rotation	D1	D2	D3	B	L	S
R108.050.R	5	8,5	11,5	25	100	10
SPARE KNIFE	D					
R108.051.R	5					

HS TWIST DRILLS Z=2

ART. R208

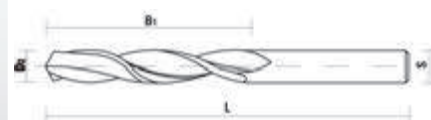

Ø 9÷11 No step drills



Ø 13÷22 Step drills

For Anuba SFS INTECK

RH rotation	D2	D1	B1	B	L	S	Anuba
R208.090.R	5,2		52		132	5,2	9
R208.110.R	5,7		57		139	5,7	11
R208.130.R	6,7	5,3	63	12	148	6,7	13
R208.140.R	7,2	5,8	69	13	156	7,2	14
R208.160.R	7,7	6,3	75	14	165	7,7	16
R208.180.R	8,6	7,2	81	14	175	8,6	18
R208.200.R	8,8	7,4	81	16	175	8,8	20
R208.220.R	10,2	8,8	87	23	184	10,2	22

HW ADJUSTABLE DIAMETER BORING BITS 30/60 MM

ART. R110

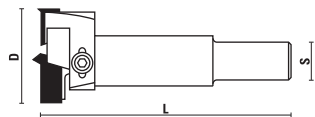

Complete with 1 knife \varnothing 30÷45 mm + 1 knife \varnothing 45÷60 + key

RH rotation	D	L	S
R110.600.R	30÷60	90	10x30

SPARE KNIFE

R110.300.R	30÷45
R110.450.R	45÷60



Z051.012.R

HW ADJUSTABLE DIAMETER BORING BITS 60/80 MM

ART. R110

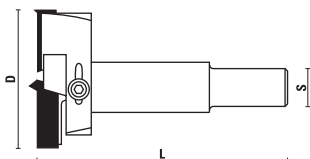

Complete with 1 knife \varnothing 60÷80 + key

RH rotation	D	L	S
R110.800.R	60÷80	100	12x40

SPARE KNIFE

R110.801.R	60÷80
------------	-------



Z051.013.R



HW HINGE BORING BITS Z=2+2

ART. R111



For soft and hard wood, plywood and laminated chipboard



RH rotation	D	L	S
R111.140.R	14	90	10x60
R111.141.R	14	120	10x100
R111.150.R	15	90	10x60
R111.151.R	15	120	10x100
R111.160.R	16	90	10x60
R111.161.R	16	120	10x100
R111.170.R	17	90	10x60
R111.180.R	18	90	10x60
R111.181.R	18	120	10x100
R111.190.R	19	90	10x60
R111.200.R	20	90	10x60
R111.201.R	20	120	10x100
R111.210.R	21	90	10x60
R111.220.R	22	90	10x60
R111.221.R	22	120	10x100
R111.230.R	23	90	10x60
R111.240.R	24	90	10x60
R111.250.R	25	90	10x60
R111.251.R	25	120	10x100
R111.260.R	26	90	10x60
R111.261.R	26	120	10x100
R111.270.R	27	90	10x60
R111.280.R	28	90	10x60
R111.300.R	30	90	10x60
R111.301.R	30	120	10x100
R111.320.R	32	90	10x60
R111.340.R	34	90	10x60
R111.350.R	35	90	10x60
R111.351.R	35	120	10x100
R111.360.R	36	90	10x60
R111.380.R	38	90	10x60
R111.400.R	40	90	10x60
R111.401.R	40	120	10x100
R111.420.R	42	90	10x60
R111.450.R	45	90	10x60
R111.480.R	48	90	10x60
R111.500.R	50	90	10x60
R111.550.R	55	90	10x60
R111.600.R	60	90	10x60

R111.905.R 5 drills set \varnothing 15 -20 -25 -30 -35



HW HINGE BORING BITS Z=2+2

ART. R112

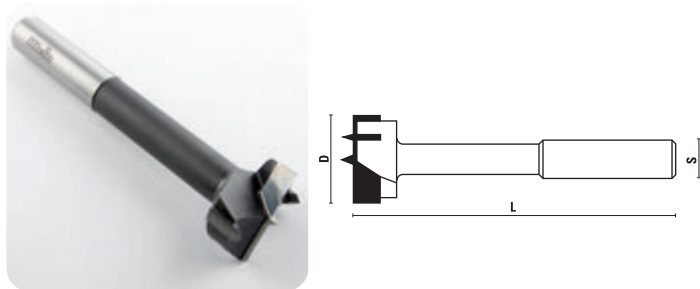

For soft and hard wood, plywood and laminated chipboard

RH rotation	D	L	S
R112.150.R	16	120	13x50
R112.160.R	16	120	13x50
R112.200.R	20	120	13x50
R112.220.R	22	130	13x50
R112.240.R	24	130	13x50
R112.250.R	25	130	13x50
R112.260.R	26	130	13x50
R112.280.R	28	130	13x50
R112.300.R	30	130	13x50
R112.320.R	32	130	16x50
R112.350.R	35	130	16x50
R112.400.R	40	130	16x50
R112.450.R	45	130	16x50
R112.500.R	50	130	16x50
R112.550.R	55	140	16x50
R112.600.R	60	140	16x50
R112.650.R	65	140	16x50
R112.700.R	70	140	16x50
R112.800.R	80	140	20x50
R112.900.R	90	140	20x50

T.C.T. HINGE BORING BITS Z=2+2 (art. R111-R112)

How to determine the feeding speed according to the machine (RPM):

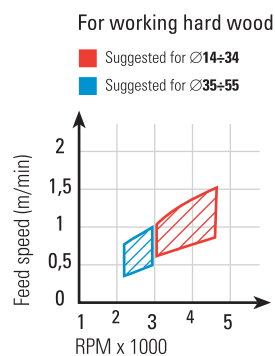

HW INTERCHANGEABLE HINGE BORING BITS Z=2+2

ART. R130

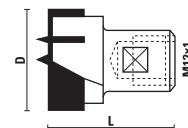

Use with Art. Z021

RH rotation	LH rotation	D	L
R130.200.R	R130.200.L	20	30
R130.250.R	R130.250.L	25	30
R130.260.R	R130.260.L	26	30
R130.280.R	R130.280.L	28	30
R130.300.R	R130.300.L	30	30
R130.320.R	R130.320.L	32	30
R130.340.R	R130.340.L	34	30
R130.350.R	R130.350.L	35	30
R130.360.R	R130.360.L	36	30
R130.380.R	R130.380.L	38	30
R130.400.R	R130.400.L	40	30
R130.450.R		45	30
R130.480.R		48	30
R130.500.R		50	30
R130.550.R		55	30
R130.600.R		60	30
R130.650.R		65	30
R130.700.R		70	30

Art. Z021 see section spare part page 10.04, 10.05

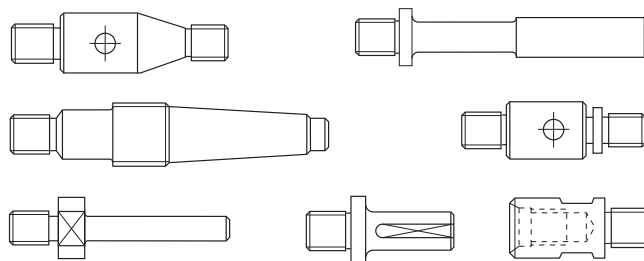

HS HINGE BORING BITS Z=2+2

ART. R211

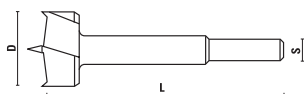

For soft and hard wood



RH rotation	D	L	S
R211.100.R	10	90	10x30
R211.120.R	12	90	10x30
R211.140.R	14	90	10x30
R211.150.R	15	90	10x30
R211.160.R	16	90	10x30
R211.180.R	18	90	10x30
R211.200.R	20	90	10x30
R211.220.R	22	90	10x30
R211.240.R	24	90	10x30
R211.250.R	25	90	10x30
R211.260.R	26	90	10x30
R211.300.R	30	90	10x30
R211.350.R	35	90	10x30
R211.400.R	40	90	10x30
R211.500.R	50	90	10x30

HS HINGE BORING BITS Z=2+2

ART. R212

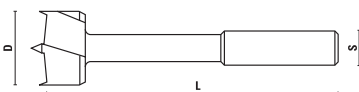

For soft and hard wood

RH rotation	D	L	S
R212.150.R	15	120	13x50
R212.200.R	20	120	13x50
R212.250.R	25	130	13x50
R212.300.R	30	130	13x50
R212.350.R	35	130	16x50
R212.400.R	40	130	16x50
R212.500.R	50	130	16x50
R212.600.R	60	140	16x50

SP "FORSTNER" BITS Z=2+2

ART. R213



For soft and hard wood



RH rotation	D	L	S
R213.100.R	10	90	8x30
R213.120.R	12	90	8x30
R213.140.R	14	90	8x30
R213.150.R	15	90	8x30
R213.160.R	16	90	8x30
R213.180.R	18	90	8x30
R213.200.R	20	90	8x30
R213.220.R	22	90	8x30
R213.240.R	24	90	8x30
R213.250.R	25	90	8x30
R213.260.R	26	90	8x30
R213.280.R	28	90	8x30
R213.300.R	30	90	8x30
R213.320.R	32	90	10x30
R213.340.R	34	90	10x30
R213.350.R	35	90	10x30
R213.360.R	36	90	10x30
R213.380.R	38	90	10x30
R213.400.R	40	90	10x30
R213.450.R	45	90	10x30
R213.500.R	50	90	10x30

R213.905.R 5 boring bits set Ø 15 - 20 - 25 - 30 - 35

R213.915.R 15 boring bits set Ø 10 - 12 - 15 - 16 - 18 - 20 - 22 - 25 - 26 - 28 - 30 - 35 - 40 - 45 - 50



R213.905.R



R213.915.R

SP "FORSTNER" BITS Z=2+2

ART. R214

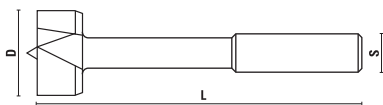

For soft and hard wood

RH rotation	D	L	S
R214.150.R	15	125	13x50
R214.200.R	20	130	13x50
R214.220.R	22	130	13x50
R214.250.R	25	135	13x50
R214.300.R	30	140	13x50
R214.350.R	35	140	16x50
R214.400.R	40	140	16x50
R214.500.R	50	140	16x50

SP PLUG CUTTERS Z=2

ART. R220

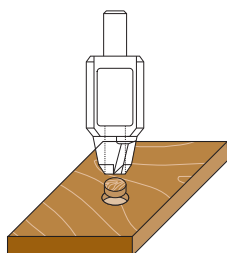
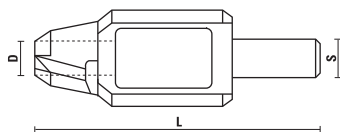

For soft and hard wood

RH rotation	D	L	S
R220.080.R	8	140	13x50
R220.100.R	10	140	13x50
R220.120.R	12	140	13x50
R220.150.R	15	140	13x50
R220.200.R	20	140	13x50
R220.250.R	25	140	13x50
R220.300.R	30	140	13x50
R220.350.R	35	140	16x50
R220.400.R	40	140	16x50

HW/HS COUNTERSINKS Z=2

ART. R150 - R250

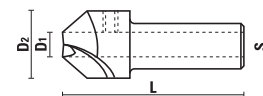

RH rotation	LH rotation	D1	D2	L	S	Mat.
R150.030.R	R150.030.L	3	15	40	10x25	HW
R150.040.R	R150.040.L	4	15	40	10x25	HW
R150.050.R	R150.050.L	5	15	40	10x25	HW
R150.060.R	R150.060.L	6	15	40	10x25	HW
R250.030.R	R250.030.L	3	15	40	10x25	HS
R250.040.R	R250.040.L	4	15	40	10x25	HS
R250.050.R	R250.050.L	5	15	40	10x25	HS
R250.060.R	R250.060.L	6	15	40	10x25	HS

HW/HS DOVETAIL BITS 9° - Z=1

ART. R151 - R251

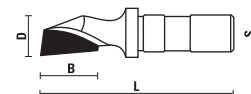

For OMEC machines

RH rotation	D	B	L	S	Z	Mat.
R151.140.R	14	18	60	12x30	1	HW
R251.140.R	14	18	60	12x30	1	HS

VHW DOVETAIL BITS Z=2

ART. R152

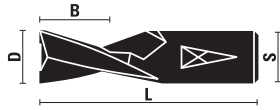

- For OMEC machines
- Solid carbide

RH rotation	D	B	L
R152.140.R	14	16	60

HW/HS DOVETAIL BITS Z=2

ART. R160 - R260



RH rotation	D	B	S	Mat.
R160.120.R	12	13	10x40	HW
R160.140.R	14	15	10x40	HW
R160.150.R	15	16	10x40	HW
R160.160.R	16	17	10x40	HW
R160.180.R	18	20	10x40	HW
R260.120.R	12	13	10x40	HS
R260.140.R	14	15	10x40	HS
R260.150.R	15	16	10x40	HS
R260.160.R	16	17	10x40	HS
R260.180.R	18	20	10x40	HS

- Add. charge for threaded shank
- Add. charge for inside threaded shank

SP SLOT MORTISING BITS WITH CHIPBREAKER Z=2

ART. S201- S202

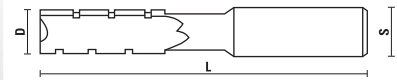

Chipbreaker execution



RH rotation	LH rotation	D	L	S
S201.060.R	S201.060.L	6	105	13x50
S201.061.R	S201.061.L	6	120	13x50 Long execution
S201.070.R	S201.070.L	7	110	13x50
S201.080.R	S201.080.L	8	115	13x50
S201.081.R	S201.081.L	8	130	13x50 Long execution
S201.090.R	S201.090.L	9	120	13x50
S201.100.R	S201.100.L	10	125	13x50
S201.101.R	S201.101.L	10	140	13x50 Long execution
S201.110.R	S201.110.L	11	130	13x50
S201.120.R	S201.120.L	12	135	13x50
S201.121.R	S201.121.L	12	150	13x50 Long execution
S201.130.R	S201.130.L	13	140	13x50
S201.140.R	S201.140.L	14	145	13x50
S201.141.R	S201.141.L	14	160	13x50 Long execution
S201.150.R	S201.150.L	15	150	13x50
S201.160.R	S201.160.L	16	155	13x50

S202.060.R	S202.060.L	6	105	16x50
S202.061.R	S202.061.L	6	120	16x50 Long execution
S202.070.R	S202.070.L	7	110	16x50
S202.080.R	S202.080.L	8	115	16x50
S202.081.R	S202.081.L	8	130	16x50 Long execution
S202.090.R	S202.090.L	9	120	16x50
S202.100.R	S202.100.L	10	125	16x50
S202.101.R	S202.101.L	10	140	16x50 Long execution
S202.110.R	S202.110.L	11	130	16x50
S202.120.R	S202.120.L	12	135	16x50
S202.121.R	S202.121.L	12	150	16x50 Long execution
S202.130.R	S202.130.L	13	140	16x50
S202.140.R	S202.140.L	14	145	16x50
S202.141.R	S202.141.L	14	160	16x50 Long execution
S202.150.R	S202.150.L	15	150	16x50
S202.160.R	S202.160.L	16	155	16x50
S202.161.R	S202.161.L	16	170	16x50 Long execution
S202.180.R	S202.180.L	18	165	16x50
S202.181.R	S202.181.L	18	180	16x50 Long execution
S202.200.R	S202.200.L	20	175	16x50
S202.220.R	S202.220.L	22	180	16x50
S202.240.R	S202.240.L	24	180	16x50

X100.006.R 6 mortising bits set Ø 6 - 8 - 10 - 12 - 14 - 16 Rh rotation

X100.006.L 6 mortising bits set Ø 6 - 8 - 10 - 12 - 14 - 16 Lh rotation

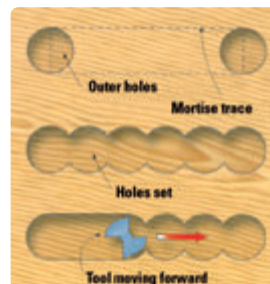

HL RECIPROCATING SLOT MORTISING BITS

ART. S210 - S211 - S212 - S213

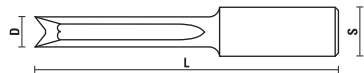

Item	D	L	S	Z
S210.060.N	6	100	16x50	2
S210.070.N	7	100	16x50	2
S210.080.N	8	100	16x50	2
S210.090.N	9	100	16x50	2
S210.100.N	10	110	16x50	2
S210.120.N	12	110	16x50	2
S210.140.N	14	110	16x50	2
S210.160.N	16	110	16x50	2
S211.060.N	6	100	13x50	4
S211.070.N	7	100	13x50	4
S211.080.N	8	100	13x50	4
S211.090.N	9	100	13x50	4
S211.100.N	10	110	13x50	4
S211.120.N	12	110	13x50	4
S211.140.N	14	110	13x50	4
S211.160.N	16	110	13x50	4
S212.060.N	6	60	12x30	2
S212.070.N	7	60	12x30	2
S212.080.N	8	60	12x30	2
S212.100.N	10	60	12x30	4
S212.120.N	12	60	12x30	4
S213.060.N	6	73	10x40	4
S213.070.N	7	73	10x40	4
S213.080.N	8	73	10x40	4
S213.100.N	10	73	10x40	4
S213.120.N	12	73	10x40	4

HL RECIPROCATING SLOT MORTISING BITS Z=3

ART. S214

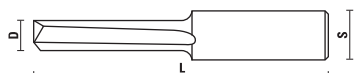

RH rotation	LH rotation	D	L	S	Z
S214.060.R	S214.060.L	6	110	16x50	3
S214.080.R	S214.080.L	8	110	16x50	3
S214.100.R	S214.100.L	10	110	16x50	3
S214.120.R	S214.120.L	12	110	16x50	3
S214.140.R	S214.140.L	14	115	16x50	3
S214.160.R	S214.160.L	16	115	16x50	3
S214.180.R	S214.180.L	18	115	16x50	3
S214.200.R	S214.200.L	20	115	16x50	3

HW RECIPROCATING SLOT MORTISING BITS

ART. S110 - S111

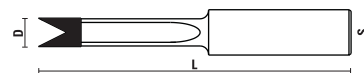

Item	D	L	S	Z
S110.060.N NEW	6	100	16x50	2
S110.080.N NEW	8	100	16x50	2
S110.100.N NEW	10	110	16x50	2
S110.120.N NEW	12	110	16x50	2
S110.140.N NEW	14	110	16x50	2
S110.160.N NEW	16	110	16x50	2
S111.060.N NEW	6	100	13x50	2
S111.080.N NEW	8	100	13x50	2
S111.100.N NEW	10	110	13x50	2
S111.120.N NEW	12	110	13x50	2
S111.140.N NEW	14	110	13x50	2
S111.160.N NEW	16	110	13x50	2

HW/KS GROOVING CUTTERS Z=2

ART. S120 - S220



For the lock housing

RH rotation	D	L	Mat.
S120.200.R	20	60	HM
S120.220.R	22	60	HM
S220.200.R	20	60	SP
S220.220.R	22	60	SP

HW/KS SLOT MORTISING CUTTERS Z=2

ART. S121 - S221

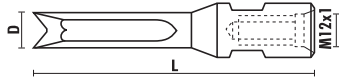

For cutting slots

RH rotation	D	L	Mat.
S121.120.R	12	100	HW
S121.140.R	14	100	HW
S221.120.R	12	100	SP
S221.140.R	14	100	SP

HW/KS BORING BITS Z=2

ART. S122 - S222

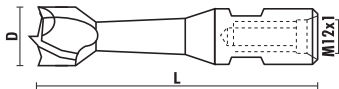

For boring

RH rotation	D	L	Mat.
S122.180.R	18	100	HW
S122.200.R	20	100	HW
S222.180.R	18	100	SP
S222.200.R	20	100	SP

HW/KS SLOT BORING BITS Z=2

ART. S123 - S223

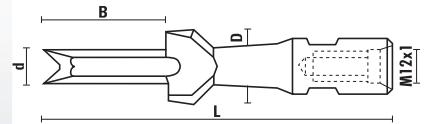

To produce slots and holes

RH rotation	d	D	B	L	Mat.
S123.110.R	11	19	62	155	HW
S123.120.R	12	19	62	155	HW
S223.110.R	11	19	62	155	SP
S223.120.R	12	19	62	155	SP

HS DOWEL CUTTERS

ART. S250

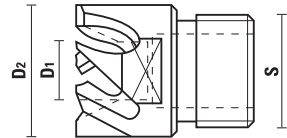

RH rotation	D1	D2	Z	S
S250.080.R	8	25	4	21/14x1"
S250.082.R	8,2	25	4	21/14x1"
S250.100.R	10	25	4	21/14x1"
S250.102.R	10,2	25	4	21/14x1"
S250.120.R	12	25	4	21/14x1"
S250.122.R	12,2	25	4	21/14x1"
S250.162.R	16,2	32	5	26/14x1"

HW HOLE SAWS

ART. S180

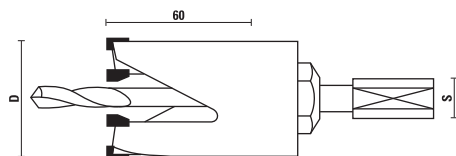

- For large boring depth, suitable for wood, chipboard, plastic materials, glass fibers ecc.
- Bore depth 60 mm
- Right hand rotation
- Single packed



Item	D	S	Z	RPM
S180.220.R	22	10	2	2.800
S180.250.R	25	10	2	2.800
S180.270.R	27	10	2	2.800
S180.300.R	30	10	2	2.300
S180.320.R NEW	32	12	2	2.300
S180.350.R	35	12	3	2.300
S180.380.R	38	12	3	2.300
S180.400.R	40	12	3	1.800
S180.450.R	45	12	3	1.800
S180.480.R	48	12	3	1.800
S180.500.R	50	12	3	1.800
S180.550.R	55	12	4	1.500
S180.600.R	60	12	4	1.500
S180.650.R	65	12	4	1.200
S180.680.R	68	12	4	1.200
S180.700.R	70	12	4	1.200
S180.750.R NEW	75	12	5	1.000
S180.800.R	80	12	5	1.000
S180.850.R NEW	85	12	5	1.000
S180.900.R	90	12	5	1.000
S180.999.R	100	12	5	700
S180.999.R127 NEW	127	12	5	500

11 pcs. display

S180.011.N (Ø22, Ø25, Ø27, Ø30, Ø35, Ø38, Ø40, Ø45, Ø50, Ø55, Ø60)



S180.011.N

Spare parts

Arbor

S181.100.R	S=10
S181.120.R	S=12

HS centering drill

S182.063.R D=6,3 L=100

Application table

WOOD		
Hard	Chipboard	Composites
XXX	XXX	XXX

PLASTIC			
Fiberglass	Acrylic	PVC	Rubber
XXX	XX	XX	XX

17 pcs. display

S180.017.N (Ø22, Ø25, Ø27, Ø30, Ø35, Ø38, Ø40, Ø45, Ø50, Ø55, Ø60, Ø65, Ø68, Ø70, Ø80, Ø90, Ø100)

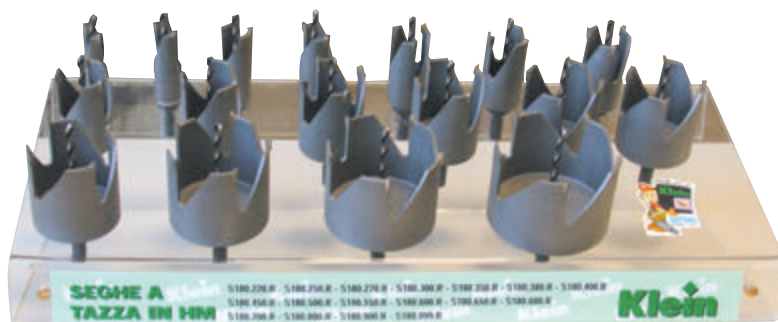

S180.017.N

HS CUTTERS FOR COPYING LATHES

ART. S260

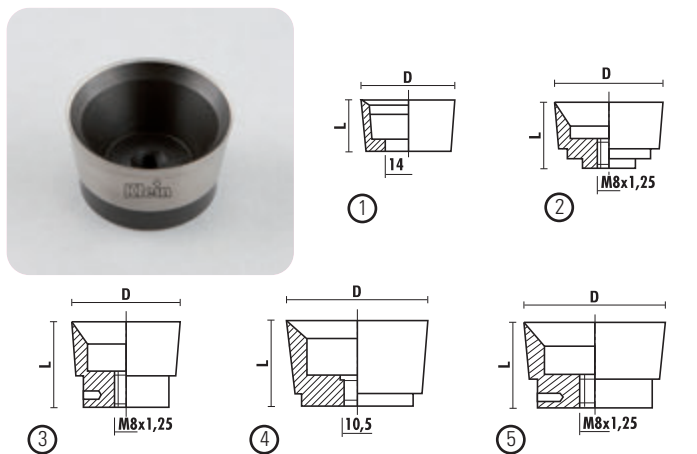

Item	Drawing	D	L
S260.320.N	1	32	15
S260.350.N	2	35	20
S260.360.N	3	36	26
S260.400.N	4	40	25
S260.450.N	5	45	26

HS CUTTERS FOR COPYING LATHES

ART. S270

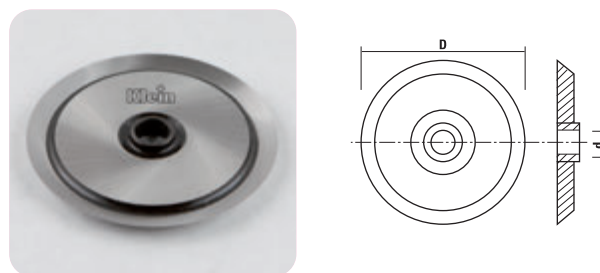

Item	D	d
S270.750.N	75	10,3

ROUTER BITS FOR DECORATIVE ROSETTES Z=2

ART. SB

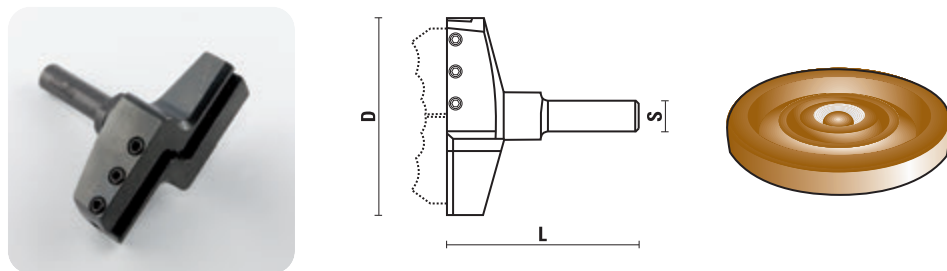

- To use on drilling machines and/or router machines
- Right hand rotation
- Supplied without knives, complete with screws and key

Item	D	L	S
SB080.000	80	81	12



Z051.407.R



Z052.406.N

Suggested RPM:

Hardwood	1.500÷2.000
Softwood	3.000÷6.000
MDF	3.000÷6.000

AVAILABLE PROFILED KNIVES FOR ROSETTE BITS

Item SB080.010÷SB080.150 T.C.T. PROFILE KNIFE

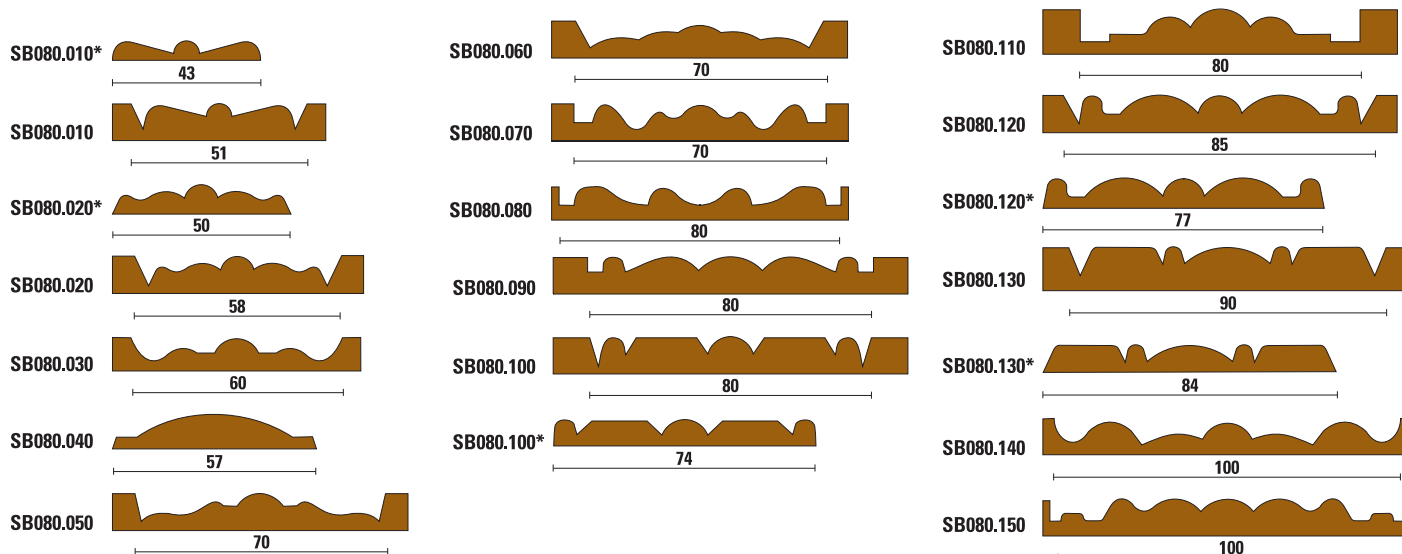

Items marked with asterisk can produce a protruding rosette for gluing

MODULAR DRAWER UNIT

Drawer unit

"Elegant, sturdy **Klein** drawer unit with an innovative, modern design and great modularity, where you can keep all your **Klein** tools in a clean, secure, well-organized place. Say good-bye to messiness and damaged tools. Now, with the new **Klein** drawer unit, you can put your storeroom in order in a convenient, functional way.



SMALL OUTSIDE BUT LARGE INSIDE
the **Klein** drawer unit takes up little space but can contain countless articles in its 10 drawers and 80 containers (8 containers per drawer).

- **STURDY**
since each drawer can hold around 8 kg.
- **LIGHT**
since it's made of a high-strength polypropylene co-polymer.
- **SECURE**
since each drawer has its own key.
- **PRACTICAL**
since it can be equipped with 4 casters for convenient movement or with slip-resistant feet.
- **CONVENIENT**
since it features a wooden top which acts as a practical surface for taking notes or keeping tools.
- **VERSATILE**
since the tubs in the drawers can be removed easily as desired.

Whether it's placed next to a CNC router, or close to a point-to-point boring machine, along the panel production line or in any carpentry shop, the new **Klein** drawer unit can be a real help in keeping the tools you use every day in perfect order and in good condition.



The new **Klein** drawer unit can hold a wide range of tools.
Ask our customer service how to receive it.

Modular drawer unit "Craftsman"

Ideal to store the most common tools in a workshop



1st Drawer

Router bits S=M12x1

- Art. F101.080.R
- F101.100.R
- F101.120.R
- F101.160.R
- F101.180.R
- F101.200.R
- F101.220.R
- F101.250.R

2nd Drawer

Router bits S=M12x1

- Art. F103.120.R
- F103.160.R
- F103.180.R
- F103.200.R
- F104.120.R
- F104.160.R
- F104.200.R
- F105.160.R

3rd Drawer

Hinge boring bits L=90

- Art. R111.150.R
- R111.180.R
- R111.200.R
- R111.250.R
- R111.260.R
- R111.300.R
- R111.350.R
- R111.400.R

4th Drawer

Forstner bits

- Art. R213.150.R
- R213.160.R
- R213.180.R
- R213.200.R
- R213.250.R
- R213.300.R
- R213.350.R
- R213.400.R

5th Drawer

Interchangeable hinge boring bits

- Art. R130.200.R
- R130.250.R
- R130.260.R
- R130.300.R
- R130.340.R
- R130.350.R
- R130.400.R
- Z021.408+410+412

6th Drawer

Interchangeable hinge boring bits

- Art. R130.450.R
- R130.480.R
- R130.500.R
- R130.550.R
- R130.600.R
- R130.650.R
- R130.700.R
- Z021.213+216+500

7th Drawer

Mortising bits R

- Art. S202.060.R
- S202.080.R
- S202.100.R
- S202.120.R
- S202.140.R
- S202.160.R
- S202.180.R
- S202.200.R

8th Drawer

Mortising bits L

- Art. S202.060.L
- S202.080.L
- S202.100.L
- S202.120.L
- S202.140.L
- S202.160.L
- S202.180.L
- S202.200.L

9th Drawer

Plug cutters

- Art. R220.080.R
- R220.100.R
- R220.120.R
- R220.150.R
- R220.200.R
- R220.250.R
- R220.300.R
- R220.350.R

10th Drawer

Reversible knives

- Art. Z055.000.N
- Z055.001.N
- Z055.003.N
- Z055.007.N
- Z055.008.N
- Z055.009.N
- Z055.010.N
- Z055.011.N

Router bits and chucks for CNC routers



7



HW ROUTER BITS Z=2
Page 7.09



VHW ROUTER BITS Z=2
Page 7.09

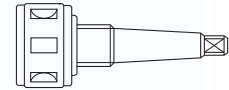

CONCENTRIC CHUCKS S=MK2
Page 7.09

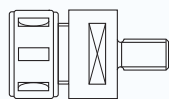

CONCENTRIC CHUCKS
Page 7.09

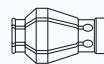

SPRING COLLETS
Page 7.09

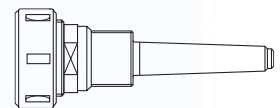

COLLET CHUCKS MORSE TAPER
Page 7.10

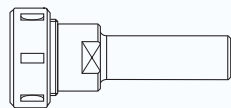

COLLET CHUCKS CYL SHANK Ø 20
Page 7.10

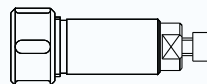

COLLET CHUCKS CYL SHANK Ø 25
Page 7.10

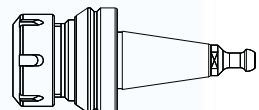

**COLLET CHUCKS ISO 30
TAPERED FLANGE**
Page 7.10

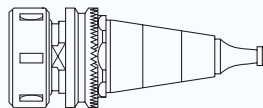

COLLET CHUCKS ISO 30
Page 7.11

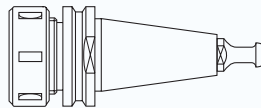

COLLET CHUCKS ISO 30
Page 7.11

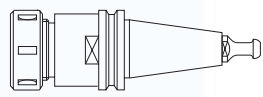

COLLET CHUCKS ISO 30
Page 7.11

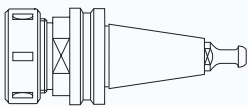

COLLET CHUCKS ISO 30
Page 7.12

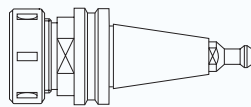

COLLET CHUCKS ISO 30
Page 7.12

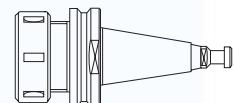

COLLET CHUCKS ISO 30
Page 7.13

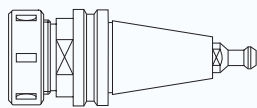

COLLET CHUCKS ISO 40
Page 7.13

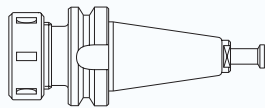

COLLET CHUCKS BT 30 - BT 35 - BT 40
Page 7.13

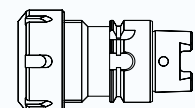

COLLET CHUCKS HSK40A
Page 7.14

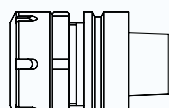

COLLET CHUCKS HSK63F
Page 7.14

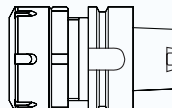

COLLET CHUCKS HSK63A
Page 7.14

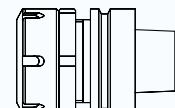

COLLET CHUCKS HSK63F
Page 7.14

Klein®



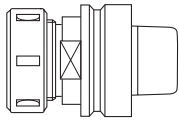

COLLET CHUCKS HSK TYPE "F"
Page 7.15

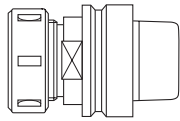

COLLET CHUCKS HSK63E
Page 7.15

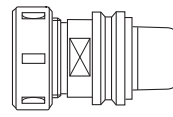

COLLET CHUCKS HSK50E 40
Page 7.15

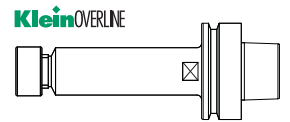

Klein OVERLINE
COLLET CHUCKS HSK63F ER16 - G 2.5
BALANCING
Page 7.16

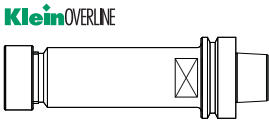

Klein OVERLINE
COLLET CHUCKS HSK63F ER32 - G 2.5
BALANCING
Page 7.17

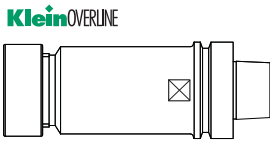

Klein OVERLINE
COLLET CHUCKS HSK63F
DIN6388/EOC25 - G 2.5 BALANCING
Page 7.17

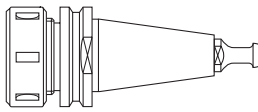

COLLET CHUCKS ISO 30 INOX
Page 7.18

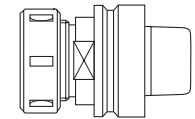

COLLET CHUCKS HSK63F INOX
Page 7.18

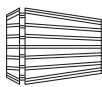

SPRING COLLETS ER 32 - DIN 6499
Page 7.20

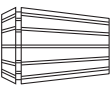

SPRING COLLETS ER 40 - DIN 6499
Page 7.20



SPRING COLLET SET ER 32 - DIN 6499
Page 7.20



SPRING COLLET SET ER 40 - DIN 6499
Page 7.20

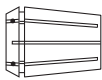

WATER-TIGHT
SPRING COLLETS ER 32 - DIN 6499
Page 7.21

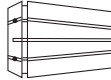

WATER-TIGHT
SPRING COLLETS ER 40 - DIN 6499
Page 7.21



WATER-TIGHT
SPRING COLLET SET ER 32 - DIN 6499
Page 7.21



WATER-TIGHT
SPRING COLLET SET ER 40 - DIN 6499
Page 7.21

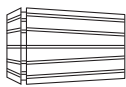

SPRING COLLETS EOC25 - DIN 6388 (462 E)
Page 7.22



SPRING COLLETS ER 20 - DIN 6499
Page 7.22



SPRING COLLETS ER 25 - DIN 6499
Page 7.22



SPRING COLLET SET ER25 - DIN 6499
Page 7.22



SPRING COLLETS ER 16 - DIN 6499
Page 7.23



SPRING COLLETS ER 11 - DIN 6499
Page 7.23



SPRING COLLETS ETS 32 - DIN 6499
Page 7.23

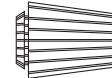

SPRING COLLETS ETS 40 - DIN 6499
Page 7.23



SPRING COLLETS EOC12 - DIN 6388 (407E)
Page 7.24



SPRING COLLETS EOC16 - DIN 6388 (415E)
Page 7.24



SPRING COLLET SET + WIPE OFF KIT
Page 7.24



SET IN WOODEN BOX
Page 7.25



SET IN PLASTIC BOX
Page 7.25

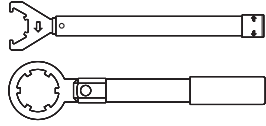

TORQUE WRENCHES
Page 7.26

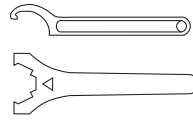

KEYS
Page 7.26

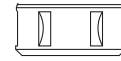

COLLET NUTS
"NO-NOISE" COLLET NUTS
Page 7.26

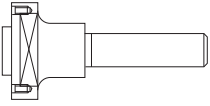

ADAPTERS FOR CIRCULAR SAWBLADES
Page 7.27

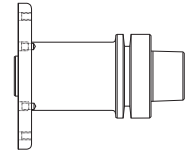

HSK63F ADAPTERS FOR CIRCULAR SAWBLADES
Page 7.27

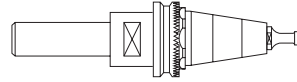

CUTTER ARBORS WITH ISO 30 TAPER
Page 7.28

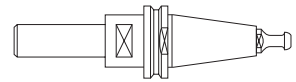

CUTTER ARBORS WITH ISO 30 - ISO 40 TAPER
Page 7.28

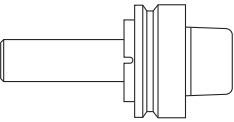

CUTTER ARBORS WITH HSK63F TAPER
CUTTER ARBORS WITH HSK63E
Page 7.29

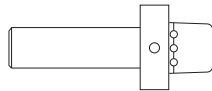

CUTTER ARBORS WITH HSK85 TAPER
Page 7.30

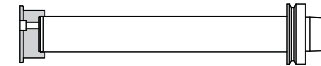

CUTTER ARBORS WITH HSK85S TAPER
Page 7.30

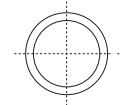

SPACERS 2-SIDES GRINDED
Page 7.31



RETAINING PAWLS FOR CONCENTRIC CHUCK
Page 7.32

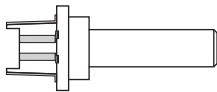

CONE WIPERS
Page 7.33

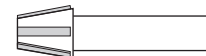

COLLET WIPERS
Page 7.33



BRUSHES FOR COLLET BORE
Page 7.33



WIPE OFF KIT
Page 7.33

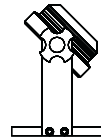

ADJUSTABLE DEMOUNT DEVICES
Page 7.34



DEMOUNT DEVICES FOR FLANGE Ø80 - Ø85
Page 7.34

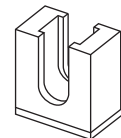

DEMOUNT DEVICES
Page 7.34

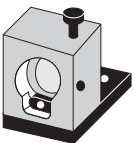

ISO 30 DEMOUNT DEVICES
Page 7.34



PROFILE CUTTERS, GROUP 1
Page 7.35



PROFILE CUTTERS, GROUP 2
Page 7.35



SOLID CARBIDE SPIRAL CUTTERS, FINISH STYLE Z=1
Page 7.38



SOLID CARBIDE SPIRAL CUTTERS, FINISH STYLE Z=1
Page 7.38



SOLID CARBIDE SPIRAL CUTTERS, FINISH STYLE Z=2
Page 7.39



SOLID CARBIDE SPIRAL CUTTERS, FINISH STYLE Z=2
Page 7.39



SOLID CARBIDE SPIRAL CUTTERS, FINISH STYLE Z=3
Page 7.40



SOLID CARBIDE SPIRAL CUTTERS,
FINISH STYLE Z=3
Page 7.40



SOLID CARBIDE SPIRAL CUTTERS,
ROUGHING STYLE Z=3
Page 7.41



SOLID CARBIDE SPIRAL CUTTERS,
ROUGHING STYLE Z=3
Page 7.41



SOLID CARBIDE SPIRAL CUTTERS Z=3
RH ROTATION
Page 7.42



SOLID CARBIDE SPIRAL CUTTERS Z=3
LH ROTATION
Page 7.42



SOLID CARBIDE SPIRAL CUTTERS,
FINISH STYLE Z=1
Page 7.42



SOLID CARBIDE SPIRAL CUTTERS,
FINISH STYLE Z=1
Page 7.41



SOLID CARBIDE SPIRAL CUTTERS,
FINISH STYLE Z=2
Page 7.43



SOLID CARBIDE SPIRAL CUTTERS,
FINISH STYLE Z=2
Page 7.43



SOLID CARBIDE SPIRAL CUTTERS,
FINISH STYLE Z=3
Page 7.43



SOLID CARBIDE SPIRAL CUTTERS,
FINISH STYLE Z=3
Page 7.43



SOLID CARBIDE SPIRAL CUTTERS,
ROUGHING STYLE Z=3
Page 7.44



SOLID CARBIDE SPIRAL CUTTERS,
ROUGHING STYLE Z=3
Page 7.44



SOLID CARBIDE COMPRESSION
CUTTERS Z=1+1
Page 7.44



SOLID CARBIDE COMPRESSION CUTTERS
Z=1+1
Page 7.44



SOLID CARBIDE COMPRESSION
CUTTERS Z=2+2
Page 7.45



SOLID CARBIDE COMPRESSION
CUTTERS Z=2+2
Page 7.45



SOLID CARBIDE SPIRAL CUTTERS Z=2 - Z=3
Page 7.46



SOLID CARBIDE SPIRAL CUTTERS Z=3
FOR LOCKS
Page 7.46



SOLID CARBIDE SPIRAL
CUTTERS Z=2
Page 7.46



SOLID CARBIDE SPIRAL CUTTERS Z=2
Page 7.46



SOLID CARBIDE SPIRAL CUTTERS,
FINISH STYLE S=6 Z=2
Page 7.47



SOLID CARBIDE SPIRAL CUTTERS,
FINISH STYLE S=6 Z=2
Page 7.47



SOLID CARBIDE SPIRAL CUTTERS,
FINISH STYLE S=8 Z=2
Page 7.47



SOLID CARBIDE SPIRAL CUTTERS,
FINISH STYLE S=8 Z=2
Page 7.47



SOLID CARBIDE SPIRAL CUTTERS,
ROUGHING STYLE Z=2
Page 7.47



SOLID CARBIDE SPIRAL CUTTERS,
ROUGHING STYLE Z=2
Page 7.47



SOLID CARBIDE SPIRAL CUTTERS
RADIUS STYLE Z=2
Page 7.48



HS ROUTER BITS FOR "HUNDEGGER"
MACHINES
Page 7.48



HS CARVING BITS, PLANE STYLE
Page 7.48

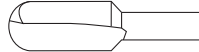

HS CARVING BITS, ROUND STYLE
Page 7.48



KleinDIA
SOLID CARBIDE SPIRAL ROUTER
BITS FINISH/ROUGHING STYLE
Page 7.49, 7.50



MODULAR DRAWER UNIT
Page 7.51

TOOL HOLDERS

Useful information:

SISTEMI has always been known for the high quality of the products offered. Keywords of this success are the **attention to production materials** and the use of the most modern construction techniques together with more accurate controls and the continuous research of innovative products.

A large complete stock helps even more our customers to be more competitive in the market.

The tool holders made of stainless steel (see page 7.18) allow to solve permanently any possibility of oxidation.

All our standard collet chucks are balanced at G 6.3 (24.000 RPM) and, on request, can be also at G 2.5 (36.000 RPM).

The new collet chucks Klein^{OVERLINE} (see page 7.16) are balanced at G 2.5 36.000 RPM for performing special executions.



Use instructions:

- 1) The collect chuck may be used only on router machines and machining centers for processing wood and wood-based material with comparable cutting characteristics.
- 2) The instructions of the machine manufacturer regarding the suitability of the clamping device have to be observed.
- 3) The direction of rotation marked on the clamping device has to be observed and followed. The direction of rotation of the tool and the collet chuck have to be the same.
- 4) Do not exceed the maximum RPM "n max" marked on the collet chuck. The maximum RPM of the system is determined by the tool, if the RPM of the tool is lower than that of the chuck.

Safety regulations:

- 1) All European and national safety regulations shall be adhered to include the safety requirements as set out in **EN 847-1, EN 847-2 e EN 847-3**.
- 2) The clamping device has to be mounted, secured and started up as per instructions of the machine manufacturer. Check the machine set-up and the direction of the rotation.

Maintenance:

A regular and **proper cleaning** of mechanical components is critical to avoid jamming during processing operations and the consequent risk of a poor finishing of the piece or even tool breakage.

The worked pieces leave impurities and debris in the collets holes, in the seats of tool holders or electro-spindles. These should be therefore cleaned daily using the **right wipers** (see items T137 and X137 at the page 7.33)



In order to avoid the risk of tool breakage during the job, make sure you answered the following questions:

- 1- Are you using the proper tool for the desired job?
- 2- Collets and tool holders are clean and the tool is inserted properly?
- 3- RPM and feed speed are correct?
- 4- Is the depth cut not too excessive for the material processed?
- 5- Are there any evident vibrations of the mechanical parts?
- 6- No right answer to your problem? Stop running parts and check with your "**Klein**" distributor.

If you have to contact your distributor of technical support, have ready the following information:

- a- Type of machine being used
- b- Type of material being cut
- c- Part number of tool, "**Klein**" item
- d- RPM/feed speed/depth of cut
- e- How long did the tool worked before it broke/damaged?
- f- Have you done this operation in the past using the same tool?

SAFETY NORMS

Table 1.1: Calculation of the minimum clamping length (Safety regulation EN847-1).

On the tool shank the minimum clamping length is marked.
 The shank has to be clamped as far as possible, but at least up to the marking of the minimum clamping length (K).
 The free shank length (Lo) should be as short as possible, granting a higher rigidity and smaller risk of tool breakage.

Shank diameter S (mm)	Min. clamping length K (mm)
$S \leq 10$	$K \geq 20$
$10 < S < 25$	$K = S \times 2$
$S \geq 25$	$K = S \times 1,8$

WRONG ASSEMBLING

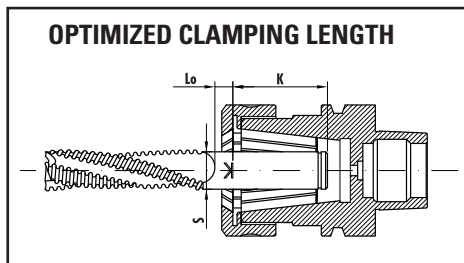
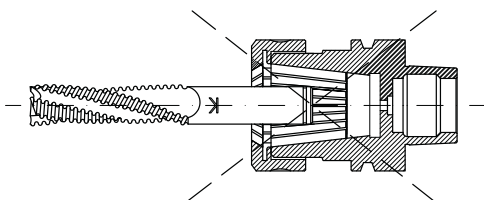

WRONG ASSEMBLING

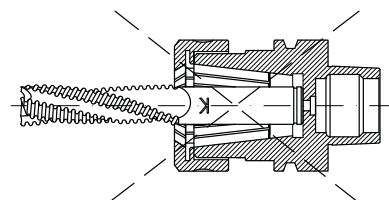

Safety norm for the calculation of the minimum clamping length

- D = Tool diameter
- B = Maximum safe length of the tool
- S = Shank diameter

COLLET CHUCKS ISO30

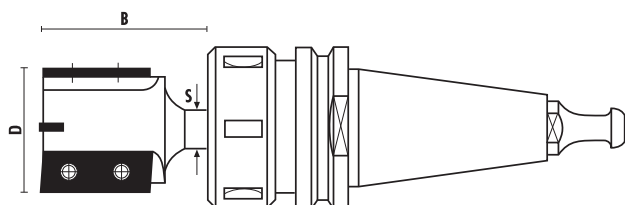

COLLET CHUCKS HSK63F

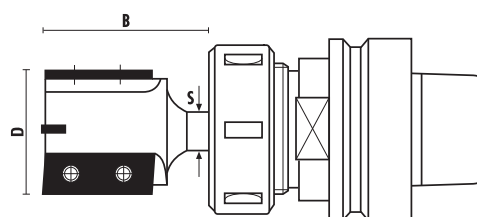

Table 2.1: Method for the calculation of the measure B for collet chucks ISO30

D (mm)	S (mm)								
	Ø 6	Ø 8	Ø 10	Ø 12	Ø 14	Ø 16	Ø 18	Ø 20	Ø 25
6	81								
8	66	94							
10	59	82	105						
12	53	73	94	115					
14	48	66	85	105	124				
16	44	61	78	96	114	133			
18	41	57	73	89	106	123	140		
20	38	53	68	84	99	115	132	148	
25		45	59	72	86	100	114	129	153
30		40	52	64	77	89	102	115	125
35			47	58	69	81	92	104	106
40			43	53	64	74	85	91	92
45				49	59	68	78	80	81
50				46	55	64	71	71	73
55					51	60	64	64	66
60					48	56	58	59	60
65					46	52	53	54	56
70						48	49	50	52
75						46	47	49	51
80							47	47	51
85								47	51
90								47	50
95								47	50
100								47	50
105									49
110									49

Table 2.2: Method for the calculation of the measure B for collet chucks HSK63F

D (mm)	S (mm)									
	Ø 6	Ø 8	Ø 10	Ø 12	Ø 14	Ø 16	Ø 18	Ø 20	Ø 25	
6	81									
8	68	94								
10	59	82	105							
12	53	73	94	115						
14	48	66	85	105	124					
16	44	61	78	96	114	133				
18	41	57	73	89	106	123	140			
20	38	53	68	84	99	115	132	148		
25		45	59	72	86	100	114	129	165	
30		40	52	64	77	89	102	115	147	
35			47	58	69	81	92	104	133	
40				43	53	64	74	85	95	123
45					49	59	68	78	88	114
50					46	55	64	73	83	106
55						51	60	69	78	100
60						48	56	65	73	94
65						46	53	61	69	90
70							51	59	66	85
75							48	55	63	82
80								53	60	78
85								51	58	75
90								49	56	72
95									56	70
100									52	68
105										65
110										64

HW ROUTER BITS Z=2

ART. T110

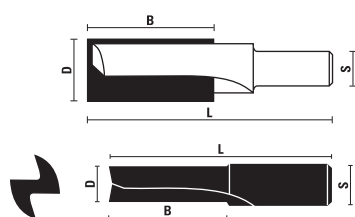

RH rotation	D	B	L	S
T110.030.R ▲	3	8	38	9,5x20
T110.040.R ▲	4	10	39	9,5x20
T110.050.R ▲	5	12	41	9,5x20
T110.060.R ▲	6	16	43	9,5x20
T110.070.R ▲	7	18	45	9,5x20
T110.080.R ▲	8	20	48	9,5x20
T110.081.R ▲	8	30	60	9,5x20
T110.090.R ▲	9	22	52	9,5x20
T110.100.R ▲	10	24	52	9,5x20
T110.101.R ▲	10	35	65	9,5x20
T110.110.R	11	30	60	9,5x20
T110.120.R	12	30	60	12x20
T110.121.R ▲	12	40	70	12x20
T110.130.R	13	30	60	12x20
T110.140.R	14	40	65	12x20
T110.150.R	15	40	65	12x20
T110.160.R	16	40	65	12x20
T110.180.R	18	40	70	12x20
T110.200.R	20	40	70	12x20
T110.220.R	22	40	70	12x20
T110.240.R	24	40	70	12x20
T110.250.R	25	40	70	12x20
T110.260.R	26	42	70	12x20
T110.280.R	28	42	70	12x20
T110.300.R	30	42	70	12x20

▲ Solid carbide

VHW ROUTER BITS Z=2

ART. T112

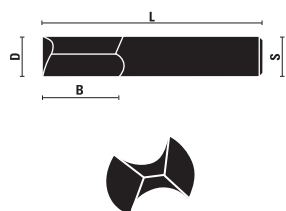

- Solid carbide
- Indicated for plastic and acrylic material, plexiglass, polypropylene etc.
- "O" flute straight

RH rotation	D	B	L	S
T112.050.R	5	12	48	5
T112.060.R	6	14	50	6
T112.080.R	8	18	55	8
T112.100.R	10	20	58	10
T112.120.R	12	26	64	12

CONCENTRIC CHUCKS S=MK2

ART. T116

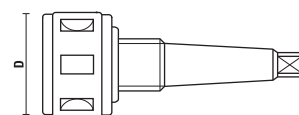

- Wrench art. Z052.301.N
- Spare parts see page 10.07

Supplied with nut (without collet)

Item	D	Shank	Clamping nut
T116.100.R	40	C.M. 2/FIL M20	Z091.000.R
T116.100.L	40	C.M. 2/FIL M20	Z091.000.L

CONCENTRIC CHUCKS

ART. T116

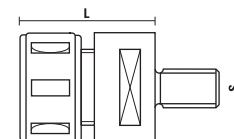

- Wrench art. Z052.301.N
- Spare parts see page 10.07

- With spare collets Art. T117
- To use on spindle moulder
- Supplied with nut (without collet)

RH rotation	S	L	Clamping nut
T116.500.R	M16	42	Z091.000.R
T116.501.R	M14	42	Z091.000.R
T116.502.R	M18	42	Z091.000.R
T116.503.R	M20	42	Z091.000.R

X116.500.R Set with chuck M16 + 3 spring collets Ø 6/8/12

X116.501.R Set with chuck M14 + 3 spring collets Ø 6/8/12

X116.502.R Set with chuck M18 + 3 spring collets Ø 6/8/12

X116.503.R Set with chuck M20 + 3 spring collets Ø 6/8/12

SPRING COLLETS

ART. T117

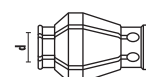

For Art. T116

Item	D
T117.060.N	6
T117.064.N	6,4
T117.080.N	8
T117.090.N	9
T117.095.N	9,5
T117.100.N	10
T117.110.N	11
T117.120.N	12
T117.127.N	12,7
T117.130.N	13
T117.140.N	14

COLLET CHUCKS MORSE TAPER

ART. T118

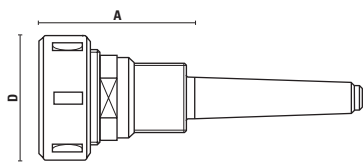

- Supplied with nut (without collet)
- Threaded nut and wrenches see page 7.26, spring collets see page 7.20
- Threaded nut DIN 6499

Item	Shank	A	D	Spring collets	Clamping nut	Rot.
T118.200.R	MK2 / FIL. M30	70	50	∅ 2÷20 (Art. T119/ER32)	Z091.001.R	RH
T118.200.L	MK2 / FIL. M30	70	50	∅ 2÷20 (Art. T119/ER32)	Z091.001.L	LH
T118.202.R	MK2 / FIL. M30	70	50	∅ 2÷20 (Art. T119/ER32)	Z091.101.R ball bearing nut	RH
T118.300.R	MK3 / FIL. M30	70	50	∅ 2÷20 (Art. T119/ER32)	Z091.001.R	RH
T118.300.L	MK3 / FIL. M30	70	50	∅ 2÷20 (Art. T119/ER32)	Z091.001.L	LH
T118.302.R	MK3 / FIL. M30	70	50	∅ 2÷20 (Art. T119/ER32)	Z091.101.R ball bearing nut	RH

COLLET CHUCKS CYL SHANK ∅ 20

ART. T118

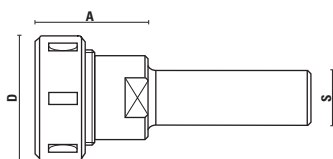

- Supplied with nut (without collet)
- Threaded nut and wrenches see page 7.26, spring collets see page 7.20
- Threaded nut DIN 6499

Item	S	A	D	Spring collets	Clamping nut	Rot.
T118.400.R	∅ 20	51	50	∅ 2÷20 (Art. T119/ER32)	Z091.001.R	RH
T118.402.R	∅ 20	51	50	∅ 2÷20 (Art. T119/ER32)	Z091.101.R ball bearing nut	RH

COLLET CHUCKS CYL SHANK ∅ 25

ART. T118

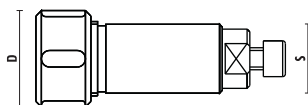

- Supplied with nut (without collet)
- Threaded nut and wrenches see page 7.26, spring collets see page 7.20
- Threaded nut DIN 6388/EOC12

- For: **Weeke**

Item	S	D	Spring collets	Clamping nut	Rot.
T118.580.R NEW	∅ 25	35	∅ 1÷12,7 (Art. T136/EOC12)	Z091.205.R	RH

COLLET CHUCKS ISO 30 TAPERED FLANGE

ART. T118

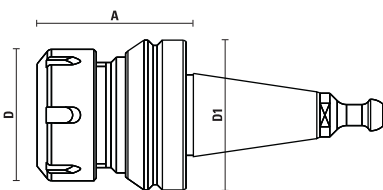

- Supplied with nut (without collet) and retaining pawl
- Threaded nut and wrenches see page 7.26, spring collets see page 7.20
- Threaded nut DIN 6499

- Retaining pawl T118.891.R for: **Thermwood**

Item	A	D	D1	Spring collets	Clamping nut	Rot.
T118.680.R NEW	58	50	57	∅ 2÷20 (Art. T119/ER32)	Z091.001.R	RH

COLLET CHUCKS ISO 30

ART. T118

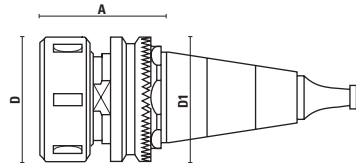

- Supplied with nut (without collet) and retaining pawl
- Threaded nut and wrenches see page 7.26, spring collets see page 7.20, 7.22
- Threaded nut DIN 6499
- Threaded nut DIN 6388/EOC25

With anti-adherent surface treatment "Impreglon"

- Retaining pawl T118.790.R for:
Morbidelli, SCM

Item	A	D	D1	Spring collets	Clamping nut	Rot.
T118.700.R	55	50	49	∅ 2÷20 (Art. T119/ER32)	Z091.001.R	RH
T118.702.R	55	50	49	∅ 2÷20 (Art. T119/ER32)	Z091.101.R ball bearing nut	RH
T118.701.R	71	60	49	∅ 3÷25 (Art. T124/EOC25)	Z091.203.R ball bearing nut	RH
T118.711.R	71	60	49	∅ 3÷25 (Art. T124/EOC25)	Z091.202.R	RH
T118.711.L selling out	71	60	49	∅ 3÷25 (Art. T124/EOC25)	Z091.202.L	LH

COLLET CHUCKS ISO 30

ART. T118

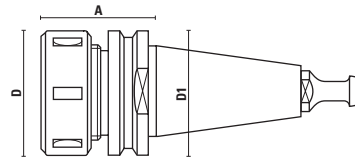

- Supplied with nut (without collet) and retaining pawl
- Threaded nut and wrenches see page 7.26, spring collets see page 7.20
- Threaded nut DIN 6499

- Retaining pawl T118.891.R for:
Biesse (after 09/09/92), **Masterwood - Bulleri** (motor H.S.D.)

Item	A	D	D1	Spring collets	Clamping nut	Rot.
T118.800.R	50	50	50	∅ 2÷20 (Art. T119/ER32)	Z091.001.R	RH
T118.800.L	50	50	50	∅ 2÷20 (Art. T119/ER32)	Z091.001.L	LH
T118.802.R	50	50	50	∅ 2÷20 (Art. T119/ER32)	Z091.101.R ball bearing nut	RH
T118.830.R	60	63	50	∅ 2÷30 (Art. T123/ER40)	Z091.002.R	RH
T118.830.L	60	63	50	∅ 2÷30 (Art. T123/ER40)	Z091.002.L	LH
T118.832.R	60	63	50	∅ 2÷30 (Art. T123/ER40)	Z091.102.R ball bearing nut	RH

COLLET CHUCKS ISO 30

ART. T118

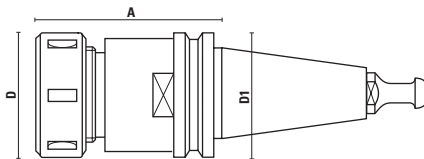

- Supplied with nut (without collet) and retaining pawl
- Threaded nut and wrenches see page 7.26, spring collets see page 7.20
- Threaded nut DIN 6499

- Retaining pawl T118.891.R for:
Biesse (after 09/09/92), **Masterwood - Bulleri** (motor H.S.D.)

Item	A	D	D1	Spring collets	Clamping nut	Rot.
T118.804.R	68	50	50	∅ 2÷20 (Art. T119/ER32)	Z091.001.R	RH
T118.804.L	68	50	50	∅ 2÷20 (Art. T119/ER32)	Z091.001.L	LH
T118.806.R	68	50	50	∅ 2÷20 (Art. T119/ER32)	Z091.101.R ball bearing nut	RH
T118.834.R	68	63	50	∅ 2÷30 (Art. T123/ER40)	Z091.002.R	RH
T118.834.L	68	63	50	∅ 2÷30 (Art. T123/ER40)	Z091.002.L	LH
T118.836.R	68	63	50	∅ 2÷30 (Art. T123/ER40)	Z091.102.R ball bearing nut	RH

COLLET CHUCKS ISO 30

ART. T118

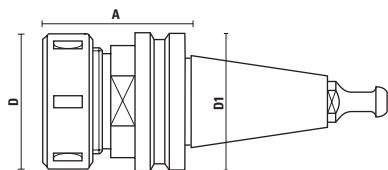

- Supplied with nut (without collet) and retaining pawl
- Threaded nut and wrenches see page 7.26, spring collets see page 7.22
- Threaded nut DIN 6388 (EOC25)

- Retaining pawl T118.791.R (DIN 69872) for:
Busellato, Weeke, Ima, Bulleri, Maka, Cosmec, Reichenbacher

Item	A	D	D ₁	Spring collets	Clamping nut	Rot.
T118.828.R NEW	68	60	50	∅ 3÷25 (Art. T124/EOC25)	Z091.202.R	RH
T118.829.R NEW	68	60	50	∅ 3÷25 (Art. T124/EOC25)	Z091.203.R ball bearing nut	RH

- Retaining pawl T118.891.R for:
Biesse (after 09/09/92), **Masterwood - Bulleri** (motor H.S.D.)

Item	A	D	D ₁	Spring collets	Clamping nut	Rot.
T118.838.R NEW	68	60	50	∅ 3÷25 (Art. T124/EOC25)	Z091.202.R	RH
T118.839.R NEW	68	60	50	∅ 3÷25 (Art. T124/EOC25)	Z091.203.R ball bearing nut	RH

COLLET CHUCKS ISO 30

ART. T118

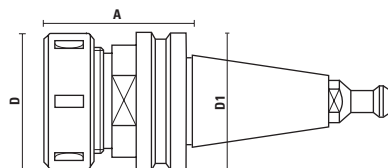

- Supplied with nut (without collet) and retaining pawl
- Threaded nut and wrenches see page 7.26, spring collets see page 7.20, 7.23
- Threaded nut DIN 6499

- Retaining pawl T118.792.R for:
Alberti, Vitap, Masterwood (motor G. Colombo)

Item	A	D	D ₁	Spring collets	Clamping nut	Rot.
T118.810.R	68	50	50	∅ 2÷20 (Art. T119/ER32)	Z091.001.R	RH
T118.810.L	68	50	50	∅ 2÷20 (Art. T119/ER32)	Z091.001.L	LH
T118.812.R	68	50	50	∅ 2÷20 (Art. T119/ER32)	Z091.101.R ball bearing nut	RH
T118.814.R	68	63	50	∅ 2÷30 (Art. T123/ER40)	Z091.002.R	RH
T118.814.L	68	63	50	∅ 2÷30 (Art. T123/ER40)	Z091.002.L	LH
T118.816.R	68	63	50	∅ 2÷30 (Art. T123/ER40)	Z091.102.R ball bearing nut	RH

- Retaining pawl T118.791.R (DIN 69872) for:
Busellato, Weeke, Ima, Bulleri, Maka, Cosmec, Reichenbacher

Item	A	D	D ₁	Spring collets	Clamping nut	Rot.
T118.820.R	68	50	50	∅ 2÷20 (Art. T119/ER32)	Z091.001.R	RH
T118.820.L	68	50	50	∅ 2÷20 (Art. T119/ER32)	Z091.001.L	LH
T118.822.R	68	50	50	∅ 2÷20 (Art. T119/ER32)	Z091.101.R ball bearing nut	RH
T118.824.R	68	63	50	∅ 2÷30 (Art. T123/ER40)	Z091.002.R	RH
T118.824.L	68	63	50	∅ 2÷30 (Art. T123/ER40)	Z091.002.L	LH
T118.826.R	68	63	50	∅ 2÷30 (Art. T123/ER40)	Z091.102.R ball bearing nut	RH

- Retaining pawl T118.794.R for:
CMS (flange ∅ 46)

Item	A	D	D ₁	Spring collets	Clamping nut	Rot.
T118.880.R	52	50	46	∅ 3÷20 (Art. T134/ETS32)	Z091.301.R	RH
T118.881.R	52	50	46	∅ 3÷20 (Art. T119/ER32)	Z091.001.R	RH
T118.882.R	57	63	46	∅ 4÷25 (Art. T135/ETS40)	Z091.302.R	RH
T118.883.R	57	63	46	∅ 4÷25 (Art. T123/ER40)	Z091.002.R	RH

COLLET CHUCKS ISO 30

ART. T118

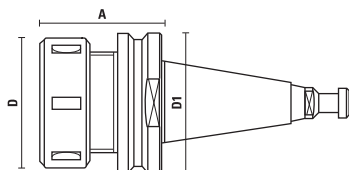

- Supplied with nut (without collet) and retaining pawl
- Threaded nut and wrenches see page 7.26, spring collets see page 7.20
- Threaded nut DIN 6499

- Retaining pawl T118.791.R for electrospindles **Elte**

Item	A	D	D1	Spring collets	Clamping nut	Rot.
T118.845.R	50	50	58	∅ 2÷20 (Art. T119/ER32)	Z091.001.R	RH
T118.846.R	50	50	58	∅ 2÷20 (Art. T119/ER32)	Z091.101.R ball bearing nut	RH
T118.847.R	56	63	58	∅ 2÷30 (Art. T123/ER40)	Z091.002.R	RH
T118.848.R	56	63	58	∅ 2÷30 (Art. T123/ER40)	Z091.102.R ball bearing nut	RH

- Retaining pawl T118.793.R for: **Esseteam** (solid flange)

Item	A	D	D1	Spring collets	Clamping nut	Rot.
T118.861.R	50	50	58	∅ 2÷20 (Art. T119/ER32)	Z091.001.R	RH
T118.862.R	50	50	58	∅ 2÷20 (Art. T119/ER32)	Z091.101.R ball bearing nut	RH
T118.864.R	56	63	58	∅ 2÷30 (Art. T123/ER40)	Z091.002.R	RH
T118.866.R	56	63	58	∅ 2÷30 (Art. T123/ER40)	Z091.102.R ball bearing nut	RH

COLLET CHUCKS ISO 40

ART. T118

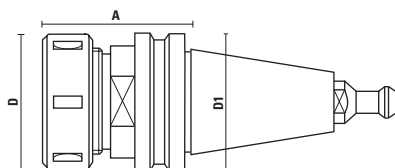

- Supplied with nut (without collet) and retaining pawl
- Threaded nut and wrenches see page 7.26, spring collets see page 7.20
- Threaded nut DIN 6499

- Retaining pawl T118.893.R for:
IMA, Weeke, Maka, Reichenbacher, Stegherr

Item	A	D	D1	Spring collets	Clamping nut	Rot.
T118.850.R	73	50	63,5	∅ 2÷20 (Art. T119/ER32)	Z091.001.R	RH
T118.852.R	73	50	63,5	∅ 2÷20 (Art. T119/ER32)	Z091.101.R ball bearing nut	RH
T118.870.R	73	63	63,5	∅ 2÷30 (Art. T123/ER40)	Z091.002.R	RH
T118.872.R	73	63	63,5	∅ 2÷30 (Art. T123/ER40)	Z091.102.R ball bearing nut	RH

COLLET CHUCKS BT 30 - BT 35 - BT 40

ART. T118

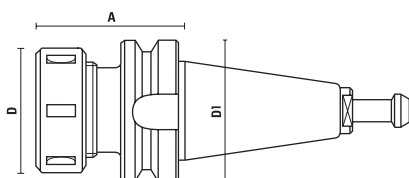

- Supplied with nut (without collet) and retaining pawl
- Threaded nut and wrenches see page 7.26, spring collets see page 7.20
- Threaded nut DIN 6499

- Retaining pawl T118.895.R for: BT 30 **Shoda**
- Retaining pawl T118.896.R for: BT 35 **Heian**
- Retaining pawl T118.897.R for: BT 40 **Shoda**

Item	Tipo	A	D	D1	Spring collets	Clamping nut	Rot.
T118.910.R	BT 30	60	50	46	∅ 2÷20 (Art. T119/ER32)	Z091.101.R ball bearing nut	RH
T118.912.R	BT 30	70	63	46	∅ 2÷30 (Art. T123/ER40)	Z091.102.R ball bearing nut	RH
T118.920.R	BT 35	69	50	53	∅ 2÷20 (Art. T119/ER32)	Z091.101.R ball bearing nut	RH
T118.922.R	BT 35	60	63	53	∅ 2÷30 (Art. T123/ER40)	Z091.102.R ball bearing nut	RH
T118.930.R	BT 40	65	50	63	∅ 2÷20 (Art. T119/ER32)	Z091.101.R ball bearing nut	RH

COLLET CHUCKS HSK40A

ART. T118

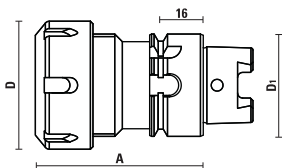

- Supplied with nut (without collet)
- Threaded nut and wrenches see page 7.26, spring collets see page 7.20
- Threaded nut DIN 6499

- For "Centauro"

Item	A	D	D1	Spring collets	Clamping nut	Rot.
T118.950.R NEW	65	50	40	Ø 2÷20 (Art. T119/ER32)	Z091.001.R	RH

COLLET CHUCKS HSK63F

ART. T118

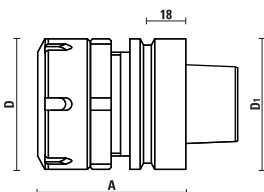

- Supplied with nut (without collet) and return ring nut
- Threaded nut and wrenches see page 7.26, spring collets see page 7.20
- Threaded nut DIN 6499

- For "Essetre"

Item	A	D	D1	Spring collets	Clamping nut	Return ring nut	Rot.
T118.953.R NEW	71	63	63	Ø 2÷30 (Art. T123/ER40)	Z091.002.R	Z091.902.R	RH

COLLET CHUCKS HSK63A

ART. T118

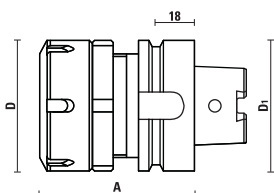

- Supplied with nut (without collet) and return ring nut
- Threaded nut and wrenches see page 7.26, spring collets see page 7.20
- Threaded nut DIN 6499

- For "Essetre"

Item	A	D	D1	Spring collets	Clamping nut	Return ring nut	Rot.
T118.956.R NEW	71	63	63	Ø 2÷30 (Art. T123/ER40)	Z091.002.R	Z091.902.R	RH

COLLET CHUCKS HSK63F

ART. T118

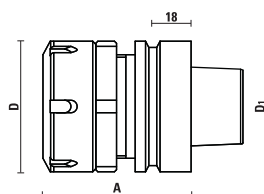

- Supplied with nut (without collet) and return ring nut
- Threaded nut and wrenches see page 7.26, spring collets see page 7.20
- Threaded nut DIN 6499

- For "Uniteam"

Item	A	D	D1	Spring collets	Clamping nut	Return ring nut	Rot.
T118.959.R NEW	79	63	63	Ø 2÷30 (Art. T123/ER40)	Z091.002.R	Z091.902.R	RH

COLLET CHUCKS HSK TYPE "F"

ART. T118

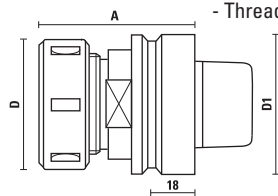

- Supplied with nut (without collet)
- Threaded nut and wrenches see page 7.26, spring collets see page 7.20, 7.22
- Threaded nut DIN 6499
- Threaded nut DIN 6388 (EOC25)

Item		A	D	D1	Spring collets	Clamping nut	Rot.
T118.966.R	HSK 50 F	73	50	50	∅ 2÷20 (Art. T119/ER32)	Z091.001.R	RH
T118.968.R	HSK 50 F	76	50	50	∅ 2÷20 (Art. T119/ER32)	Z091.101.R ball bearing nut	RH
T118.974.R	HSK 50 F	78	60	50	∅ 3÷26 (Art. T124/EOC25)	Z091.203.R	RH
T118.975.R NEW	HSK 63 F	70	42	63	∅ 3÷16 (Art. T125/ER25)	Z091.103.R	RH
T118.976.R	HSK 63 F	75	50	63	∅ 2÷20 (Art. T119/ER32)	Z091.001.R	RH
T118.976.L	HSK 63 F	75	50	63	∅ 2÷20 (Art. T119/ER32)	Z091.001.L	LH
T118.978.R	HSK 63 F	76	50	63	∅ 2÷20 (Art. T119/ER32)	Z091.101.R ball bearing nut	RH
T118.980.R	HSK 63 F	75	63	63	∅ 2÷30 (Art. T123/ER40)	Z091.002.R	RH
T118.980.L	HSK 63 F	75	63	63	∅ 2÷30 (Art. T123/ER40)	Z091.002.L	LH
T118.982.R	HSK 63 F	78	63	63	∅ 2÷30 (Art. T123/ER40)	Z091.102.R ball bearing nut	RH
T118.983.R	HSK 63 F	78	60	63	∅ 3÷26 (Art. T124/EOC25)	Z091.202.R	RH
T118.984.R	HSK 63 F	78	60	63	∅ 3÷26 (Art. T124/EOC25)	Z091.203.R ball bearing nut	RH
T118.994.R NEW	HSK 63 F	115	60	63	∅ 2÷30 (Art. T124/EOC25)	Z091.203.R ball bearing nut	RH

COLLET CHUCKS HSK63E

ART. T118

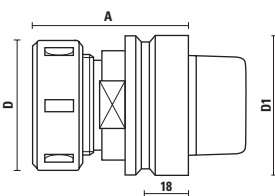

- Supplied with nut (without collet)
- Threaded nut and wrenches see page 7.26, spring collets see page 7.20, 7.23
- Threaded nut DIN 6499

Item		A	D	D1	Spring collets	Clamping nut	Rot.
T118.985.R		76	50	63	∅ 2÷20 (Art. T119/ER32)	Z091.001.R	RH
T118.986.R		76	50	63	∅ 2÷30 (Art. T134/ETS32)	Z091.301.R	RH
T118.987.R		76	63	63	∅ 2÷30 (Art. T123/ER40)	Z091.002.R	RH
T118.988.R		76	63	63	∅ 4÷25 (Art. T135/ETS40)	Z091.302.R	RH

COLLET CHUCKS HSK50E 40

ART. T118

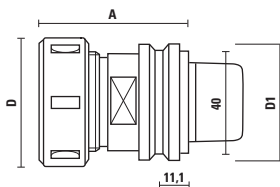

- Supplied with nut (without collet)
- Threaded nut and wrenches see page 7.26, spring collets see page 7.22
- Threaded nut DIN 6388 (EOC25)

- For ALBERTI "Polar"

Item		A	D	D1	Spring collets	Clamping nut	Rot.
T118.996.R		75	60	50	∅ 3÷26 (Art. T124/EOC25)	Z091.203.R ball bearing nut	RH

COLLET CHUCKS HSK63F HIGH SPEED LOW NOISE KleinOVERLINE

The increasing use of 5-axis machines has enabled to the step up the possible workings and with it the need to perform operations in tight and hard to reach spaces.

In order to meet these needs with the utmost precision and excellent finishes we offer a range of special HSK63F tool holders for collets **ER16**, **ER32** and **DIN6388/EOC25**, balanced at grade **G 2.5 at 36,000 RPM**.

Main features KleinOVERLINE

- | | |
|---------------------------|--|
| x - Accessibility | ✓ - Extended length tool holders, reaching 200 mm. |
| x - Balance | ✓ - G 2.5 balancing grade |
| x - Rotation speed | ✓ - 36.000 RPM |
| x - Noiselessness | ✓ - No-noise nuts, with ground contours |

These nuts should be tightened with a torque wrench (our item Z052 see page 10.08) on a proper demount device (our item T139 see page 7.34), as shown in the pictures.

The toolholders are supplied with a special design nut, with no lengthwise cuts, suitable for machining at high speed. A remarkable noise decrease is also achieved.



Adjustable demount devices Art. T139 page 7.34



Insert the collet chuck in the demount devices



Tighten the nut using the torque wrench Art Z052 page 10.13

COLLET CHUCKS HSK63F ER16 - G 2.5 BALANCING

ART. TK118

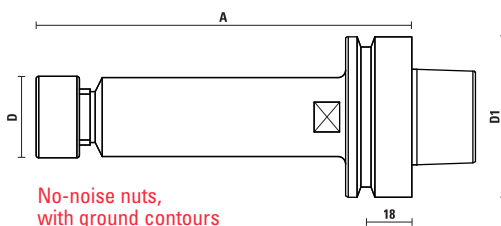

- Balanced at grade G 2.5 at 36.000 RPM
- Noise and vibrations reduction
- Supplied with nut (without collet)
- Threaded nut and wrenches see page 7.26, spring collets see page 7.23
- Threaded nut DIN 6499

On request can be supplied the standard clamping nuts (Items Z091 see page 7.26, 10.13)

Item	A	D	D1	Spring collets	Clamping nut	Rot.
TK118.900.R150 NEW	150	32	63	∅ 2÷10 (Art. T127/ER16)	Z091.505.R	Rh

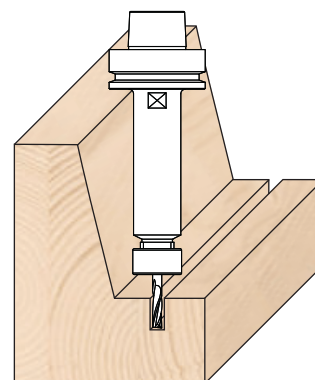
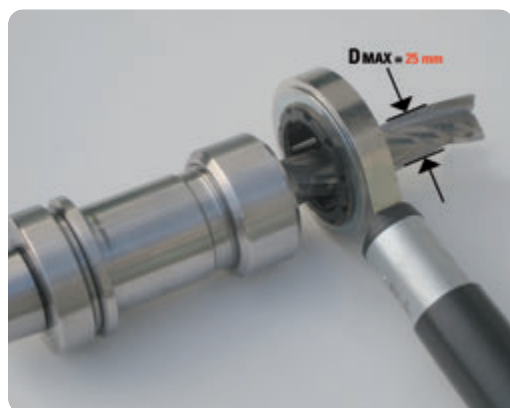

COLLET CHUCKS HSK63F ER32 - G 2.5 BALANCING

ART. TK118

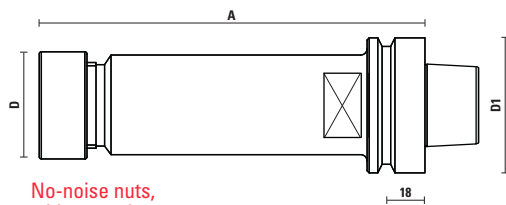

No-noise nuts,
with ground contours

- Balanced at grade G 2.5 at 36.000 RPM
- Noise and vibrations reduction
- Supplied with nut (without collet)
- Threaded nut and wrenches see page 7.26, spring collets see page 7.20
- Threaded nut DIN 6499

On request can be supplied the standard clamping nuts (Items Z091 see page 7.26, 10.13)

Item	A	D	D1	Spring collets	Clamping nut	Rot.
TK118.976.R075 NEW	75	50	63	∅ 2÷20 (Art. T119/ER32)	Z091.501.R	Rh
TK118.976.R125 NEW	125	50	63	∅ 2÷20 (Art. T119/ER32)	Z091.501.R	Rh
TK118.976.R180 NEW	180	50	63	∅ 2÷20 (Art. T119/ER32)	Z091.501.R	Rh

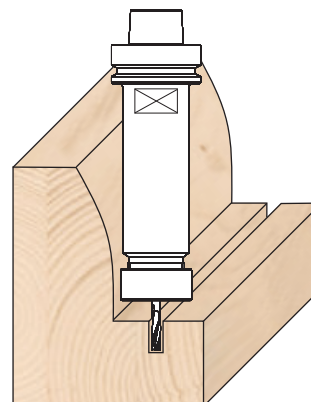
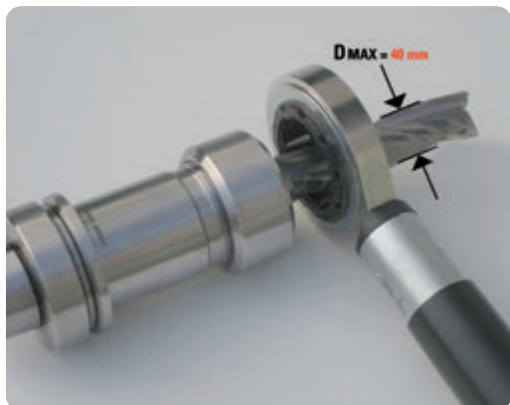

COLLET CHUCKS HSK63F DIN6388/EOC25 - G 2.5 BALANCING

ART. TK118

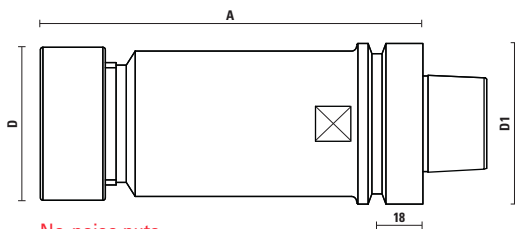

No-noise nuts,
with ground contours

- Balanced at grade G 2.5 at 36.000 RPM
- Noise and vibrations reduction
- Supplied with nut (without collet)
- Threaded nut and wrenches see page 7.26, spring collets see page 7.22
- Threaded nut DIN 6388 (EOC25)

On request can be supplied the standard clamping nuts (Items Z091 see page 7.26, 10.13)

Item	A	D	D1	Spring collets	Clamping nut	Rot.
TK118.984.R078 NEW	78	60	63	∅ 3÷26 (Art. T124/ER25)	Z091.522.R	Rh
TK118.984.R115 NEW	115	60	63	∅ 3÷26 (Art. T124/ER25)	Z091.522.R	Rh
TK118.984.R150 NEW	150	60	63	∅ 3÷26 (Art. T124/ER25)	Z091.522.R	Rh
TK118.984.R200 NEW	200	60	63	∅ 3÷26 (Art. T124/ER25)	Z091.522.R	Rh

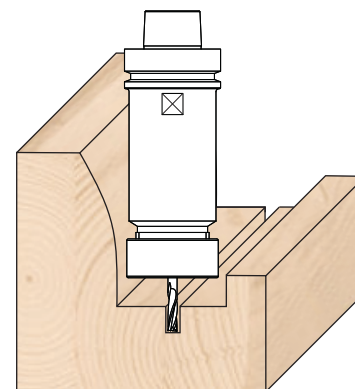
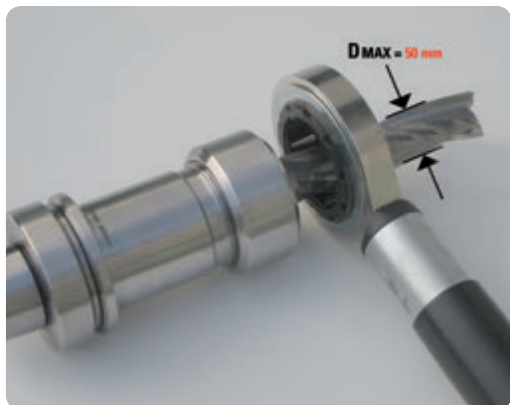

STAINLESS STEEL COLLET CHUCKS

Useful information:

- Solid stainless steel collet chucks are more resistant and have a longer life span;
- The micro-shot peening treatment guarantees an excellent resistance to corrosion and an aesthetic pleasing;
- No problems of peeling compared to coated chucks.
- Better working performances and longer life of the electrospindles.

COLLET CHUCKS ISO 30 INOX

ART. T118

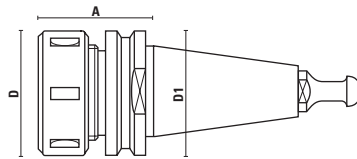

- Produced in stainless steel AISI 420
- Special micro-shot peening treatment;
- Supplied with nut (without collet) and retaining pawl;
- Needed when working with coolant: machines for marble, glass, aluminium working and others;
- Highly recommended when processing resinoid wood and composite materials
- Suggested when working in "humid" environment.
- Extremely low maintenance costs, easy to clean;
- When used with coolant our water-tight spring collets are suggested

Retaining pawl T118.891.R For: **Biesse** (after 09/09/92), **Masterwood - Bulleri** (motor H.S.D.)

Item	A	D	D1	Spring collets	Clamping nut	Rot.
T118.800.RAI	50	50	50	Ø 2÷20 (Art. T119/ER32)	Z091.001.R	RH
T118.802.RAI	50	50	50	Ø 2÷20 (Art. T119/ER32)	Z091.101.R ball bearing nut	RH
T118.830.RAI	55	63	50	Ø 2÷30 (Art. T123/ER40)	Z091.002.R	RH
T118.832.RAI	55	63	50	Ø 2÷30 (Art. T123/ER40)	Z091.102.R ball bearing nut	RH

Retaining pawl T118.792.R For: **Alberti, Vitap, Masterwood** (motor G. Colombo)

Item	A	D	D1	Spring collets	Clamping nut	Rot.
T118.811.RAI	50	50	50	Ø 2÷20 (Art. T119/ER32)	Z091.001.R	RH
T118.813.RAI	50	50	50	Ø 2÷20 (Art. T119/ER32)	Z091.101.R ball bearing nut	RH
T118.815.RAI	55	63	50	Ø 2÷30 (Art. T123/ER40)	Z091.002.R	RH
T118.817.RAI	55	63	50	Ø 2÷30 (Art. T123/ER40)	Z091.102.R ball bearing nut	RH

Retaining pawl T118.791.R (DIN 69872) For: **Busellato, Weeke, Ima, Bulleri, Maka, Cosmec, Reichenbacher, Elte**

Item	A	D	D1	Spring collets	Clamping nut	Rot.
T118.821.RAI	50	50	50	Ø 2÷20 (Art. T119/ER32)	Z091.001.R	RH
T118.823.RAI	50	50	50	Ø 2÷20 (Art. T119/ER32)	Z091.101.R ball bearing nut	RH
T118.825.RAI	55	63	50	Ø 2÷30 (Art. T123/ER40)	Z091.002.R	RH
T118.827.RAI	55	63	50	Ø 2÷30 (Art. T123/ER40)	Z091.102.R ball bearing nut	RH

COLLET CHUCKS HSK63F INOX

ART. T118

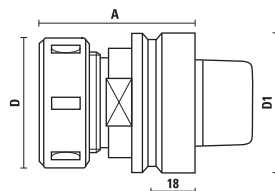

- Produced in stainless steel AISI 420
- Special micro-shot peening treatment;
- Supplied with nut (without collet) and retaining pawl;
- Needed when working with coolant: machines for marble, glass, aluminium working and others;
- Highly recommended when processing resinoid wood and composite materials
- Suggested when working in "humid" environment.
- Extremely low maintenance costs, easy to clean;
- When used with coolant our water-tight spring collets are suggested

Item	A	D	D1	Spring collets	Clamping nut	Rot.
T118.976.RAI	74	50	63	Ø 2÷20 (Art. T119/ER32)	Z091.001.R	RH
T118.978.RAI	74	50	63	Ø 2÷20 (Art. T119/ER32)	Z091.101.R ball bearing nut	RH
T118.980.RAI	77	63	63	Ø 2÷30 (Art. T123/ER40)	Z091.002.R	RH
T118.982.RAI	77	63	63	Ø 2÷30 (Art. T123/ER40)	Z091.102.R ball bearing nut	RH
T118.983.RAI	78	60	63	Ø 3÷26 (Art. T124/EOC25)	Z091.203.R	RH
T118.984.RAI	78	60	63	Ø 3÷26 (Art. T124/EOC25)	Z091.203.R ball bearing nut	RH

SPRING COLLETS

HOW TO INSERT THE SPRING COLLET IN THE NUT

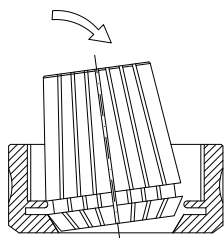

Right procedure to assemble the collet in the nut:

- place the collet diagonal to the clamping nut and lock it from the side by pressing it from top
- screw the nut and be sure the shank is correctly inserted in the spring collet (see table 1.1).
- Tighten the nut using the apposite key on the proper demount device (Art. T139, see page 7.34)
- Do not place the spring collet in the collet chuck before you have it properly inserted in the nut.**

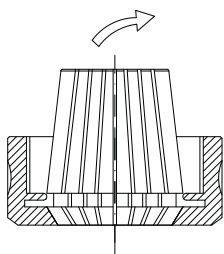

Correct procedure for tool and spring collet change:

- place the collet chuck in the mounting device
- untighten the clamping nut
- open the clamping nut and pull the cutting tool out holding it on the shank
- release the collet from the clamping nut by lateral pressure

Klein OFFERS ONLY HIGH PRECISION SPRING COLLETS:

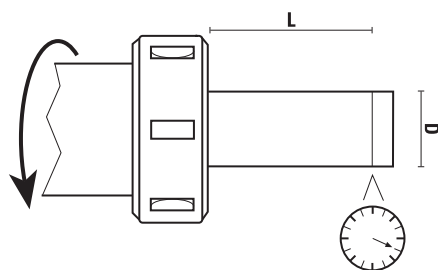

		Standard Precision	High Precision Klein
D	L		
Ø3 - Ø4 - Ø5	16	0,015	> 0,010
Ø6 ÷ Ø9,5	25	0,015	> 0,010
Ø10 ÷ Ø17	40	0,020	> 0,010
Ø18 ÷ Ø26	50	0,020	> 0,010

Using high precision spring collets vibrations on the tools and motors are reduced, assuring better results and a longer life of the tools and electrospindles.

COLLET LIFE SPAN:

Spring collets have a life span of approximately 3 months if used 8 hours a day. Replacing the collets will ensure your operation runs consistency and prevents from tool breakage.

MAINTENANCE:

Keeping spring collets and tools clean is essential for a longer life. The worked material produces chips and dirt which can cause an elliptical tool rotation. The seats of collet chucks and electrospindles should be cleaned daily with the correct tapers (see our items **T137** and **X137** at the page 7.33)



SPRING COLLETS ER 32 - DIN 6499

ART. T119

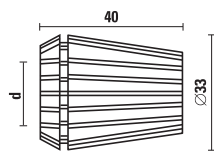

Precision= 0,01

Item	d
T119.020.N	Ø 2 - 1
T119.030.N	Ø 3 - 2
T119.032.N	Ø 3,2 - (1/8")
T119.040.N	Ø 4 - 3
T119.048.N	Ø 4,8 - (3/16")
T119.050.N	Ø 5 - 4
T119.060.N	Ø 6 - 5
T119.064.N	Ø 6,4 - (1/4")
T119.070.N	Ø 7 - 6
T119.079.N	Ø 7,9 - (5/16")
T119.080.N	Ø 8 - 7
T119.090.N	Ø 9 - 8
T119.095.N	Ø 9,5 - (3/8")
T119.100.N	Ø 10 - 9
T119.110.N	Ø 11 - 10
T119.120.N	Ø 12 - 11
T119.127.N	Ø 12,7 (1/2")
T119.130.N	Ø 13 - 12
T119.140.N	Ø 14 - 13
T119.150.N	Ø 15 - 14
T119.159.N	Ø 15,9 - (5/8")
T119.160.N	Ø 16 - 15
T119.170.N	Ø 17 - 16
T119.180.N	Ø 18 - 17
T119.190.N	Ø 19 - 18
T119.191.N	Ø 19,1 - (3/4")
T119.200.N	Ø 20 - 19

SPRING COLLET SET ER 32 - DIN 6499

ART. X119



- Complete with 18 pcs
- In carton Box

Item	Diameters:
X119.118.N	Ø3 - Ø4 - Ø5 - Ø6 - Ø7 - Ø8
	Ø9 - Ø10 - Ø11 - Ø12 - Ø13 - Ø14
	Ø15 - Ø16 - Ø17 - Ø18 - Ø19 - Ø20

SPRING COLLETS ER 40 - DIN 6499

ART. T123

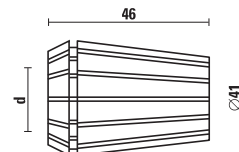

Precision= 0,01

Item	d
T123.030.N	Ø 3 - 2
T123.040.N	Ø 4 - 3
T123.048.N	Ø 4,8 - (3/16")
T123.050.N	Ø 5 - 4
T123.060.N	Ø 6 - 5
T123.064.N	Ø 6,4 - (1/4")
T123.070.N	Ø 7 - 6
T123.079.N	Ø 7,9 - (5/16")
T123.080.N	Ø 8 - 7
T123.090.N	Ø 9 - 8
T123.095.N	Ø 9,5 - (3/8")
T123.100.N	Ø 10 - 9
T123.110.N	Ø 11 - 10
T123.120.N	Ø 12 - 11
T123.127.N	Ø 12,7 - (1/2")
T123.130.N	Ø 13 - 12
T123.140.N	Ø 14 - 13
T123.150.N	Ø 15 - 14
T123.159.N	Ø 15,9 - (5/8")
T123.160.N	Ø 16 - 15
T123.170.N	Ø 17 - 16
T123.180.N	Ø 18 - 17
T123.190.N	Ø 19 - 18
T123.191.N	Ø 19,1 - (3/4")
T123.200.N	Ø 20 - 19
T123.210.N	Ø 21 - 20
T123.220.N	Ø 22 - 21
T123.230.N	Ø 23 - 22
T123.240.N	Ø 24 - 23
T123.250.N	Ø 25 - 24
T123.254.N	Ø 25,4 - (1")
T123.260.N	Ø 26 - 25
T123.300.N NEW	Ø 30 - 29

SPRING COLLET SET ER 40 - DIN 6499

ART. X123



- Complete with 23 pcs
- In carton Box

Item	Diameters:
X123.023.N	Ø3 - Ø4 - Ø5 - Ø6 - Ø7 - Ø8
	Ø9 - Ø10 - Ø11 - Ø12 - Ø13 - Ø14
	Ø15 - Ø16 - Ø17 - Ø18 - Ø19 - Ø20
	Ø21 - Ø22 - Ø23 - Ø24 - Ø25

WATER-TIGHT SPRING COLLETS ER 32 - DIN 6499

ART. T119

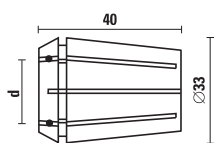

- Precision= 0,01
- Highly recommended when working with lubricant
- Indicated for working aluminium, marble, glass and others

Item	d
T119.020.NTS	Ø 2 - 1
T119.030.NTS	Ø 3 - 2
T119.040.NTS	Ø 4 - 3
T119.050.NTS	Ø 5 - 4
T119.060.NTS	Ø 6 - 5
T119.070.NTS	Ø 7 - 6
T119.080.NTS	Ø 8 - 7
T119.090.NTS	Ø 9 - 8
T119.100.NTS	Ø 10 - 9
T119.110.NTS	Ø 11 - 10
T119.120.NTS	Ø 12 - 11
T119.130.NTS	Ø 13 - 12
T119.140.NTS	Ø 14 - 13
T119.150.NTS	Ø 15 - 14
T119.160.NTS	Ø 16 - 15
T119.170.NTS	Ø 17 - 16
T119.180.NTS	Ø 18 - 17
T119.190.NTS	Ø 19 - 18
T119.200.NTS	Ø 20 - 19

WATER-TIGHT SPRING COLLET SET ER 32 - DIN 6499

ART. X119



- Complete with 18 pcs
- In carton Box

Item	Diameters:
X119.118.NTS	Ø3 - Ø4 - Ø5 - Ø6 - Ø7 - Ø8 Ø9 - Ø10 - Ø11 - Ø12 - Ø13 - Ø14 Ø15 - Ø16 - Ø17 - Ø18 - Ø19 - Ø20

WATER-TIGHT SPRING COLLETS ER 40 - DIN 6499

ART. T123

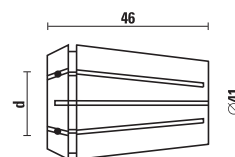
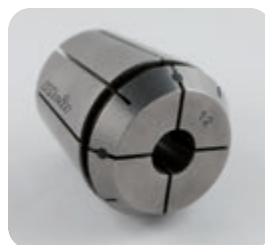

- Precision= 0,01
- Highly recommended when working with lubricant
- Indicated for working aluminium, marble, glass and others

Item	d
T123.030.NTS	Ø 3 - 2
T123.040.NTS	Ø 4 - 3
T123.050.NTS	Ø 5 - 4
T123.060.NTS	Ø 6 - 5
T123.070.NTS	Ø 7 - 6
T123.080.NTS	Ø 8 - 7
T123.090.NTS	Ø 9 - 8
T123.100.NTS	Ø 10 - 9
T123.110.NTS	Ø 11 - 10
T123.120.NTS	Ø 12 - 11
T123.130.NTS	Ø 13 - 12
T123.140.NTS	Ø 14 - 13
T123.150.NTS	Ø 15 - 14
T123.160.NTS	Ø 16 - 15
T123.170.NTS	Ø 17 - 16
T123.180.NTS	Ø 18 - 17
T123.190.NTS	Ø 19 - 18
T123.200.NTS	Ø 20 - 19
T123.210.NTS	Ø 21 - 20
T123.220.NTS	Ø 22 - 21
T123.230.NTS	Ø 23 - 22
T123.240.NTS	Ø 24 - 23
T123.250.NTS	Ø 25 - 24
T123.260.NTS	Ø 26 - 25

WATER-TIGHT SPRING COLLET SET ER 40 - DIN 6499

ART. X123



- Complete with 23 pcs
- In carton Box

Item	Diameters:
X123.023.NTS	Ø3 - Ø4 - Ø5 - Ø6 - Ø7 - Ø8 Ø9 - Ø10 - Ø11 - Ø12 - Ø13 - Ø14 Ø15 - Ø16 - Ø17 - Ø18 - Ø19 - Ø20 Ø21 - Ø22 - Ø23 - Ø24 - Ø25

SPRING COLLETS EOC25 - DIN 6388 (462 E)

ART. T124

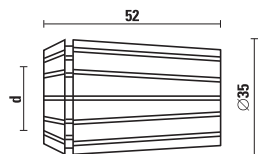

Precision= 0,01

Item	d
T124.020.N	Ø 2 - 1,5
T124.030.N	Ø 3 - 2,5
T124.040.N	Ø 4 - 3,5
T124.050.N	Ø 5 - 4,5
T124.060.N	Ø 6 - 5,5
T124.064.N	Ø 6,4 - (1/4")
T124.070.N	Ø 7 - 6,5
T124.080.N	Ø 8 - 7,5
T124.095.N	Ø 9,5 - (3/8")
T124.100.N	Ø 10 - 9,5
T124.110.N	Ø 11 - 10,5
T124.120.N	Ø 12 - 11,5
T124.130.N	Ø 13 - 12,5 - (1/2")
T124.140.N	Ø 14 - 13,5
T124.159.N	Ø 15,9 - (5/8")
T124.160.N	Ø 16 - 15,5
T124.180.N	Ø 18 - 17,5
T124.191.N	Ø 19,1 - (3/4")
T124.200.N	Ø 20 - 19,5
T124.220.N	Ø 22 - 21,5
T124.250.N	Ø 25 - 24,5
T124.254.N	Ø 25,4 - (1")

SPRING COLLETS ER 20 - DIN 6499

ART. T126

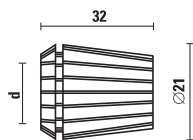

Precision= 0,01

Item	d
T126.030.N	Ø 3 - 2
T126.032.N	Ø 3,2 - (1/8")
T126.040.N	Ø 4 - 3
T126.050.N	Ø 5 - 4
T126.060.N	Ø 6 - 5
T126.064.N	Ø 6,4 - (1/4")
T126.080.N	Ø 8 - 7
T126.090.N	Ø 9 - 8
T126.095.N	Ø 9,5 - (3/8")
T126.100.N	Ø 10 - 9
T126.110.N	Ø 11 - 10
T126.120.N	Ø 12 - 11
T126.127.N	Ø 12,7 - (1/2")
T126.130.N	Ø 13 - 12

SPRING COLLETS ER 25 - DIN 6499

ART. T125

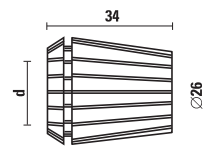

Precision= 0,01

Item	d
T125.030.N	Ø 3 - 2
T125.032.N	Ø 3,2 - (1/8")
T125.040.N	Ø 4 - 3
T125.048.N	Ø 4,8 - (3/16")
T125.050.N	Ø 5 - 4
T125.060.N	Ø 6 - 5
T125.064.N	Ø 6,4 - (1/4")
T125.070.N	Ø 7 - 6
T125.079.N	Ø 7,9 - (5/16")
T125.080.N	Ø 8 - 7
T125.090.N	Ø 9 - 8
T125.095.N	Ø 9,5 - (3/8")
T125.100.N	Ø 10 - 9
T125.110.N	Ø 11 - 10
T125.120.N	Ø 12 - 11
T125.127.N	Ø 12,7 - (1/2")
T125.130.N	Ø 13 - 12
T125.140.N	Ø 14 - 13
T125.159.N	Ø 15,9 - (5/8")
T125.160.N	Ø 16 - 15

SPRING COLLET SET ER25 - DIN 6499

ART. X125



- Complete with 14 pcs
- In wooden Box

Item	Diameters:
X125.014.N	Ø3 - Ø4 - Ø5 - Ø6 - Ø7 - Ø8 - Ø9 Ø10 - Ø11 - Ø12 - Ø13 - Ø14 - Ø15 - Ø16

SPRING COLLETS ER 16 - DIN 6499

ART. T127

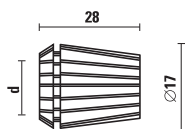

Precision= 0,01

Item	d
T127.020.N	Ø 2 - 1
T127.030.N	Ø 3 - 2
T127.032.N	Ø 3,2 - (1/8")
T127.040.N	Ø 4 - 3
T127.050.N	Ø 5 - 4
T127.060.N	Ø 6 - 5
T127.064.N	Ø 6,4 - (1/4")
T127.070.N	Ø 7 - 6
T127.080.N	Ø 8 - 7
T127.090.N	Ø 9 - 8
T127.095.N	Ø 9,5 - (3/8")
T127.100.N	Ø 10 - 9

SPRING COLLETS ETS 32 - DIN 6499

ART. T134

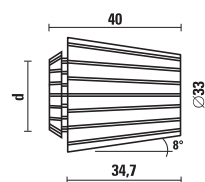

Precision= 0,01

Item	d
T134.030.N	Ø 3 - 2
T134.040.N	Ø 4 - 3
T134.050.N	Ø 5 - 4
T134.060.N	Ø 6 - 5
T134.070.N	Ø 7 - 6
T134.080.N	Ø 8 - 7
T134.100.N	Ø 10 - 9
T134.120.N	Ø 12 - 11
T134.130.N	Ø 13 - 12
T134.140.N	Ø 14 - 13
T134.160.N	Ø 16 - 15
T134.180.N	Ø 18 - 17
T134.200.N	Ø 20 - 19

SPRING COLLETS ER 11 - DIN 6499

ART. T129

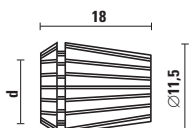

Precision= 0,01

Item	d
T129.010.N	Ø 1-0,5
T129.015.N	Ø 1,5-1
T129.020.N	Ø 2-1,5
T129.025.N	Ø 2,5-2
T129.030.N	Ø 3-2,5
T129.035.N	Ø 3,5-3
T129.040.N	Ø 4-3,5
T129.045.N	Ø 4,5-4
T129.050.N	Ø 5-4,5
T129.055.N	Ø 5,5-5
T129.060.N	Ø 6-5,5
T129.065.N	Ø 6,5-6
T129.070.N	Ø 7-6,5

SPRING COLLETS ETS 40 - DIN 6499

ART. T135

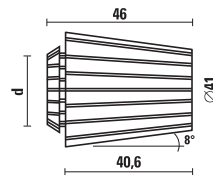

Precision= 0,01

Item	d
T135.040.N	Ø 4 - 3
T135.050.N	Ø 5 - 4
T135.060.N	Ø 6 - 5
T135.070.N	Ø 7 - 6
T135.080.N	Ø 8 - 7
T135.100.N	Ø 10 - 9
T135.120.N	Ø 12 - 11
T135.130.N	Ø 13 - 12
T135.140.N	Ø 14 - 13
T135.160.N	Ø 16 - 15
T135.180.N	Ø 18 - 17
T135.200.N	Ø 20 - 19
T135.250.N	Ø 25 - 24

SPRING COLLETS EOC12 - DIN 6388 (407E)

ART. T136

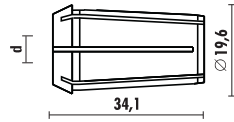

- To be used with Art. T118.580.R
- Precision= 0,01

Item	d
T136.040.N NEW	∅ 4 - 3
T136.060.N NEW	∅ 6 - 5
T136.064.N NEW	∅ 6,4 - (1/4")
T136.080.N NEW	∅ 8 - 7
T136.095.N NEW	∅ 9,5 - (3/8")
T136.100.N NEW	∅ 10 - 9
T136.120.N NEW	∅ 12 - 11
T136.127.N NEW	∅ 12,7 - (1/2")

SPRING COLLETS EOC16 - DIN 6388 (415E)

ART. T138

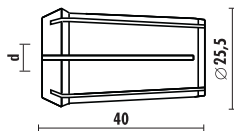

- Precision= 0,01

Item	d
T138.040.N NEW	∅ 4 - 3
T138.060.N NEW	∅ 6 - 5
T138.064.N NEW	∅ 6,4 - (1/4")
T138.080.N NEW	∅ 8 - 7
T138.095.N NEW	∅ 9,5 - (3/8")
T138.100.N NEW	∅ 10 - 9
T138.120.N NEW	∅ 12 - 11
T138.127.N NEW	∅ 12,7 - (1/2")

SPRING COLLET SET + WIPE OFF KIT



The **wipe off set** allows maintaining the inside as well as the seat of the spring collet on the chuck clean, helps increasing cutting efficiency and reduce vibrations for a longer tool life. No more risk of wrong positioning of both the collet and the tool due to chips and resin.

- In plastic box

- Set complete with:
nr. 10 spring collets
Collet wipers
Brushes for collet bore



Item
X125.515.N

Set complete with **10 spring collets ER25:**
∅3 - ∅4 - ∅5 - ∅6 - ∅7 ∅8 - ∅10 - ∅12 - ∅14 - ∅16



T137.525.N - Collet wipers ER25



X137.004.N - nr. 4 brushes for collet bore ER25



Item
X119.515.N

Set complete with **10 spring collets ER32:**
∅4 - ∅5 - ∅6 - ∅8 - ∅10 - ∅12 - ∅14 - ∅16 - ∅18 - ∅20



T137.532N - Collet wipers ER32



X137.004.N - nr. 4 brushes for collet bore ER32



Item
X123.515.N

Set complete with **10 spring collets ER40:**
∅4 - ∅6 - ∅8 - ∅10 - ∅12 - ∅14 - ∅16 - ∅18 - ∅20 - ∅25



T137.540N - Collet wipers ER40



X137.004.N - nr. 4 brushes for collet bore ER40



Item
X124.515.N

Set complete with **10 spring collets DIN6388:**
∅4 - ∅6 - ∅8 - ∅10 - ∅12 - ∅14 - ∅16 - ∅18 - ∅20 - ∅25

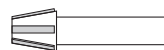

T137.662N - Collet wipers DIN6388-EOC25



X137.004.N - nr. 4 brushes for collet bore DIN6388-EOC25

SET IN WOODEN BOX

ART. X118



Complete with concentric chuck ISO30 + 8 spring collets ER32

Item X118.700.R	Item X118.800.R
complete with: concentric chuck ISO 30/ER32 T118.700.R	complete with: concentric chuck ISO 30/ER32 T118.800.R
spring collets	spring collets
∅6 T119.060.N	∅6 T119.060.N
∅8 T119.080.N	∅8 T119.080.N
∅10 T119.100.N	∅10 T119.100.N
∅12 T119.120.N	∅12 T119.120.N
∅14 T119.140.N	∅14 T119.140.N
∅16 T119.160.N	∅16 T119.160.N
∅18 T119.180.N	∅18 T119.180.N
∅20 T119.200.N	∅20 T119.200.N

SET IN PLASTIC BOX

ART. X118



- Complete with concentric chuck HSK63F + 8 spring collets ER40

Item X118.980.R NEW
complete with: concentric chuck HSK63F/ER40 T118.980.R
spring collets
∅6 T123.060.N
∅8 T123.080.N
∅10 T123.100.N
∅12 T123.120.N
∅16 T123.160.N
∅18 T123.180.N
∅20 T123.200.N
∅25 T123.250.N

SET IN PLASTIC BOX

ART. X118



- Complete with concentric chuck HSK63F + 8 spring collets ER32

Item X118.976.R NEW
complete with: concentric chuck HSK63F/ER32 T118.976.R
spring collets
∅6 T119.060.N
∅8 T119.080.N
∅10 T119.100.N
∅12 T119.120.N
∅14 T119.140.N
∅16 T119.160.N
∅18 T119.180.N
∅20 T119.200.N

SET IN PLASTIC BOX

ART. X118



- Complete with concentric chuck HSK63F with ball bearing nut + 8 spring collets EOC25

Item X118.984.R NEW
complete with: concentric chuck HSK63F/EOC25 T118.984.R
spring collets
∅6 T124.060.N
∅8 T124.080.N
∅10 T124.100.N
∅12 T124.120.N
∅16 T124.160.N
∅18 T124.180.N
∅20 T124.200.N
∅25 T124.250.N

TORQUE WRENCHES

While setting a tool it is extremely important to tighten it appropriately.

If not effectively tight indeed a cutting tool could slide away from the tool holder during the working process.

On the other side, an excessive tightening can cause damages to the tool holder or spring collet or the tool itself.

The wrench indicates when the torque (Nm) is reached according to the value in the corresponding table.

TORQUE WRENCHES FOR "MINI" NUTS

ART. Z052

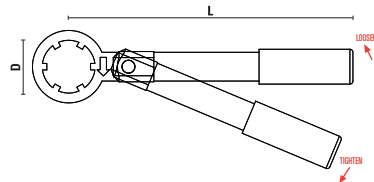

Item	D	L	Nm	Threaded nut
Z052.704.N	35	185	40	ER25

TORQUE WRENCHES FOR "STANDARD" NUTS

ART. Z052

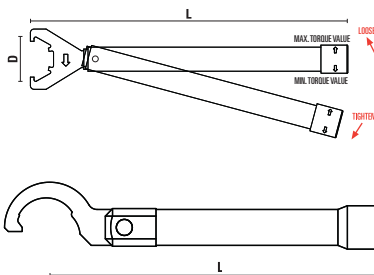

Dr. ① Collets as per drawing n. 1 must be tightened by setting the minimum torque value and rotating the handle counterclockwise.

Dr. ② Collets as per drawing n. 2 must be tightened by setting the maximum torque value and rotating the handle clockwise.

Item	D	L	Nm (Dr. 1)	Nm (Dr. 2)	Threaded nut
Z052.712.N	40	400	40-55	80-90	ER25
Z052.713.N	50	400	66-70	120-130	ER32
Z052.714.N	63	450	110-120	190-200	ER40
Z052.732.N	58-62	380	110-120	190-200	DIN6388

TORQUE WRENCHES FOR "NO-NOISE" NUTS

ART. Z052

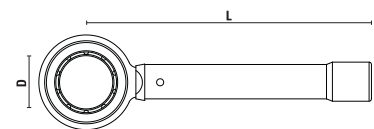

Item	D	L	Nm (dis. 1)	Nm (dis. 2)	Threaded nut
Z052.790.N NEW	32	400	25-35	45-55	ER 16
Z052.793.N NEW	50	400	65-70	120-130	ER 32
Z052.795.N NEW	60	400	110-120	190-200	DIN 6388/EOC25

KEYS

ART. Z052

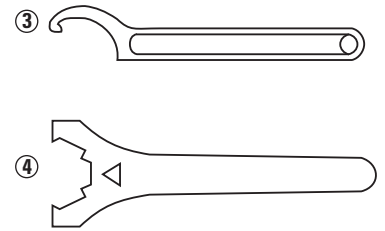

Item	Draw.	Description	Threaded nut
Z052.300.N	3	Wrench 34/38	DIN6388/EOC12
Z052.301.N	3	Wrench 40/42	Z091.000.R
Z052.310.N	3	Wrench 58/62	DIN6388/EOC25
Z052.401.N	4	Wrench for collet nut ER 32 "standard" type	
Z052.402.N	4	Wrench for collet nut ER 40 "standard" type	
Z052.407.N	4	Wrench for collet nut ER 25 "standard" type	

COLLET NUTS

ART. Z091

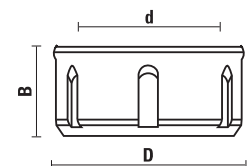

Item	Type	D	B	d	Rot.
Z091.001.R	DIN 6499 (ER 32)	50	23	M 40x1,5	RH
Z091.001.L	DIN 6499 (ER 32)	50	23	M 40x1,5	LH
Z091.002.R	DIN 6499 (ER 40)	63	25	M 50x1,5	RH
Z091.002.L	DIN 6499 (ER 40)	63	25	M 50x1,5	LH
Z091.100.R	DIN 6499 (ER 25) ball bearing	42	20	M 32x1,5	RH
Z091.101.R	DIN 6499 (ER 32) ball bearing	50	26	M 40x1,5	RH
Z091.102.R	DIN 6499 (ER 40) ball bearing	63	29	M 50x1,5	RH
Z091.103.R	DIN 6499 (ER 25)	42	20	M 32x1,5	RH
Z091.104.R	DIN 6499 (ER 20)	35	19	M 25x1,5	RH
Z091.105.R	DIN 6499 (ER 16)	32	17,5	M 22x1,5	RH
Z091.202.R	DIN 6388 (EOC25)	60	30	M 48x2	RH
Z091.203.R	DIN 6388 (EOC25) ball bearing	60	30	M 48x2	RH
Z091.301.R	ETS 32	50	23	M 40x1,5	RH
Z091.302.R	ETS 40	63	25	M 50x1,5	RH

"NO-NOISE" COLLET NUTS

ART. Z091

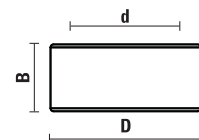

- Recommended when using router bits working at higher RPM
- Threaded nut with ground contours, remarkable reduction of noise

Item	D	B	d	Rot.
Z091.501.R NEW	DIN 6499 (ER 32)	50	23	M 40x1,5 RH
Z091.505.R NEW	DIN 6499 (ER 16)	32	17,5	M 22x1,5 RH
Z091.522.R NEW	DIN 6499 (EOC 25)	60	30	M 48x2 RH

You can find all spare parts in the section n. 10

ADAPTERS FOR CIRCULAR SAWBLADES

ART. T128

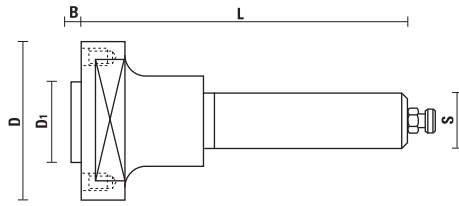

- Nr. 4 pin holes with M6/90° and 48 mm pitch circle diameter
- Complete with nr. 4 screws to fix the sawblade
- For mounting of sawblades with 30 mm bore
- Recommended to use sawblades with diameters between 150 and 200 mm

Item	D	D1	B	S	L
T128.140.R	60	30	3,5	Ø20x60	90



Z051.014.R



Z051.506.R

HSK63F ADAPTERS FOR CIRCULAR SAWBLADES

ART. T128

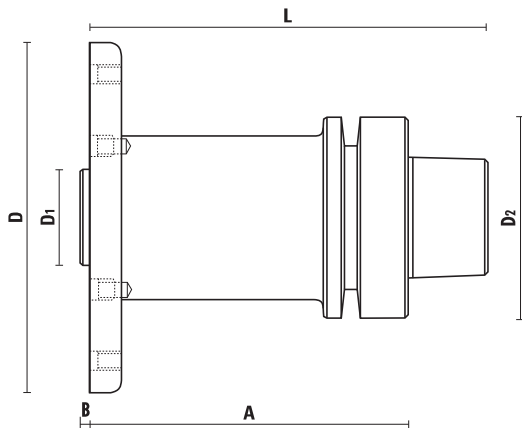
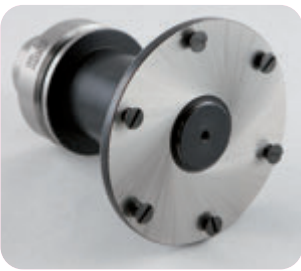

- For mounting Saws with 30 mm bore
- 6 screws M6/60° at 90 mm distance
- For mounting Saw Blades with diameter between 200 and 300 mm.

Item	A	D	D1	D2	B	L
T128.160.R	40	110	30	63	2,5	65
T128.165.R	100	110	30	63	2,5	125



Z051.014.R

EXAMPLE OF USE:
HSK63F adapter with mounted Saw Blade

TECHNICAL DATA OF SAW BLADE PIN HOLES:
6 Pin holes with 6 mm. diameter at 60° degrees and 90mm. pitch circle diameter

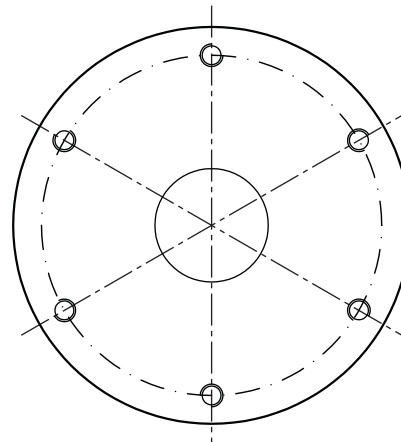
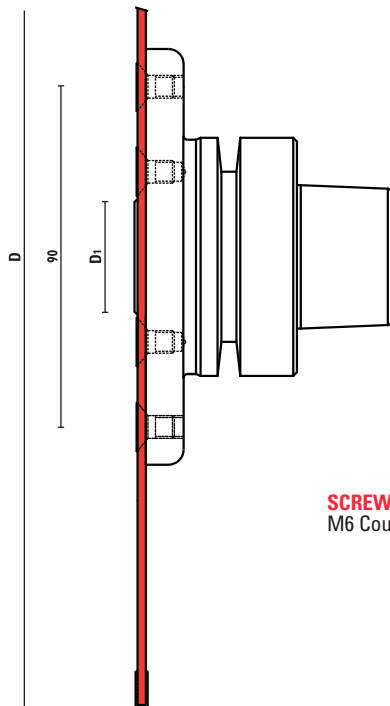

SCREW:
M6 Countersunk flat head screw

CUTTER ARBORS WITH ISO 30 TAPER

ART. T128

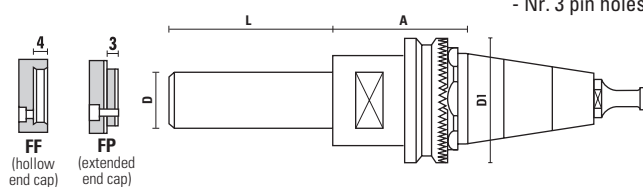

- Complete with retaining pawl page 7.33 and end cap page 10.14

- Nr. 3 pin holes to 120°

- Retaining pawl T118.790.R for: **Morbidelli, SCM**

Item		A	D	D1	L	End cap
T128.690.N	ISO 30	39	30	49	70	FF - Z092.001.R
T128.700.N	ISO 30	39	30	49	100	FF - Z092.001.R
T128.690.NM NEW	ISO 30	39	30	49	70	FP - Z092.002.R
T128.700.NM NEW	ISO 30	39	30	49	100	FP - Z092.002.R



Z051.016.R

CUTTER ARBORS WITH ISO 30 - ISO 40 TAPER

ART. T128

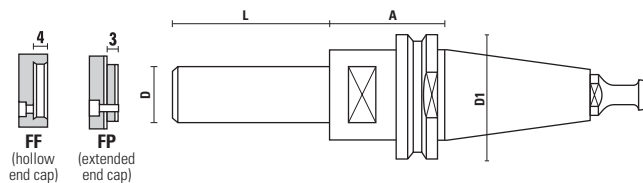

- Complete with retaining pawl page 7.33 and end cap page 10.14

- **Other retaining pawl on request**

Retaining pawl T118.891.R for: **Biesse, Masterwood - Bulleri (motor H.S.D.)**

Item		A	D	D1	L	End cap
T128.790.N	ISO 30	35	30	50	70	FF - Z092.001.R
T128.800.N	ISO 30	35	30	50	100	FF - Z092.001.R
T128.790.NM NEW	ISO 30	35	30	50	70	FP - Z092.002.R
T128.800.NM NEW	ISO 30	35	30	50	100	FP - Z092.002.R
T128.800.N120 NEW	ISO 30	35	30	50	120	FF - Z092.001.R
T128.800.N120M NEW	ISO 30	35	30	50	120	FP - Z092.002.R

Retaining pawl T118.792.R for: **Alberti, Vitap, Masterwood (motor G. Colombo)**

Item		A	D	D1	L	End cap
T128.791.N	ISO 30	35	30	50	70	FF - Z092.001.R
T128.801.N	ISO 30	35	30	50	100	FF - Z092.001.R
T128.791.NM NEW	ISO 30	35	30	50	70	FP - Z092.002.R
T128.801.NM NEW	ISO 30	35	30	50	100	FP - Z092.002.R

Retaining pawl T118.791.R (DIN 69872) for: **Busellato, Weeke, Ima, Bulleri, Maka, Cosmec, Reichenbacher, Elte**

Item		A	D	D1	L	End cap
T128.792.N	ISO 30	35	30	50	70	FF - Z092.001.R
T128.802.N	ISO 30	35	30	50	100	FF - Z092.001.R
T128.792.NM NEW	ISO 30	35	30	50	70	FP - Z092.002.R
T128.802.NM NEW	ISO 30	35	30	50	100	FP - Z092.002.R

Retaining pawl T118.893.R for: **Ima, Weeke, Maka, Reichenbacher, Stegherr**

Item		A	D	D1	L	End cap
T128.850.N	ISO 40	35	30	63,5	100	FF - Z092.001.R
T128.850.NM NEW	ISO 40	35	30	63,5	100	FP - Z092.002.R



Z051.016.R

CUTTER ARBORS WITH HSK63F TAPER

ART. T128

- Complete with end cap page 10.14

- Nr. 3 pin holes to 120°

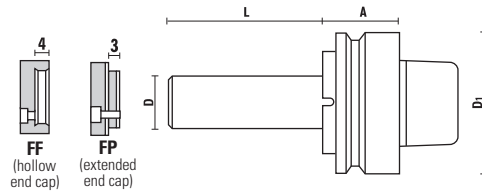

Item		A	D	D1	L	End cap
T128.970.R	HSK 63 F	33	30	63	70	FF - Z092.001.R
T128.970.RM NEW	HSK 63 F	33	30	63	70	FP - Z092.002.R
T128.980.R	HSK 63 F	33	30	63	100	FF - Z092.001.R
T128.980.RM NEW	HSK 63 F	33	30	63	100	FP - Z092.002.R
T128.980.R060M	HSK 63 F	33	30	63	60	FP - Z092.002.R
T128.980.R075M	HSK 63 F	33	30	63	75	FP - Z092.002.R
T128.980.R080M	HSK 63 F	33	30	63	80	FP - Z092.002.R
T128.980.R090M	HSK 63 F	33	30	63	90	FP - Z092.002.R
T128.980.R095M	HSK 63 F	33	30	63	95	FP - Z092.002.R
T128.980.R105M	HSK 63 F	33	30	63	105	FP - Z092.002.R
T128.980.R110M	HSK 63 F	33	30	63	110	FP - Z092.002.R
T128.980.R115M	HSK 63 F	33	30	63	115	FP - Z092.002.R
T128.980.R120M	HSK 63 F	33	30	63	120	FP - Z092.002.R
T128.980.R125M	HSK 63 F	33	30	63	125	FP - Z092.002.R
T128.980.R130M	HSK 63 F	33	30	63	130	FP - Z092.002.R
T128.980.R135M	HSK 63 F	33	30	63	135	FP - Z092.002.R
T128.980.R140M	HSK 63 F	33	30	63	140	FP - Z092.002.R
T128.980.R145M	HSK 63 F	33	30	63	145	FP - Z092.002.R
T128.980.R150M	HSK 63 F	33	30	63	150	FP - Z092.002.R
T128.980.R180M	HSK 63 F	33	30	63	180	FP - Z092.002.R
T128.980.1x125M NEW	HSK 63 F	33	1"	63	125	FP - Z092.008.R
T128.980.1,25x125M NEW	HSK 63 F	33	1-1/4"	63	125	FP - Z092.010.R
T128.980.35x100 NEW	HSK 63 F	33	35	63	100	FF - Z092.003.R
T128.980.35x100M NEW	HSK 63 F	33	35	63	100	FP - Z092.004.R
T128.980.40x100 NEW	HSK 63 F	33	40	63	100	FF - Z092.005.R
T128.980.40x100M NEW	HSK 63 F	33	40	63	100	FP - Z092.006.R
Item		A	D	D1	L	End cap
T128.972.R	HSK 63 F	42	30	63	70	FF - Z092.001.R
T128.972.RM NEW	HSK 63 F	42	30	63	70	FP - Z092.002.R
T128.982.R	HSK 63 F	42	30	63	80	FF - Z092.001.R
T128.982.RM NEW	HSK 63 F	42	30	63	80	FP - Z092.002.R
T128.982.R080 NEW	HSK 63 F	42	30	63	80	FF - Z092.001.R
T128.982.R080M NEW	HSK 63 F	42	30	63	80	FP - Z092.002.R
T128.982.R125 NEW	HSK 63 F	42	30	63	125	FF - Z092.001.R
T128.982.R125M NEW	HSK 63 F	42	30	63	125	FP - Z092.002.R
T128.982.1,25x125M NEW	HSK 63 F	42	1-1/4"	63	125	FP - Z092.010.R
T128.982.35x100 NEW	HSK 63 F	42	35	63	100	FF - Z092.003.R
T128.982.35x100M NEW	HSK 63 F	42	35	63	100	FP - Z092.004.R
T128.988.R	HSK 63 E	42	30	63	100	FF - Z092.001.R

CUTTER ARBORS WITH HSK63E



Z051.016.R

CUTTER ARBORS WITH HSK85 TAPER

ART. T130 - T131 - T132

- Complete with end cap page 10.14

- Nr. 3 pin holes to 120°

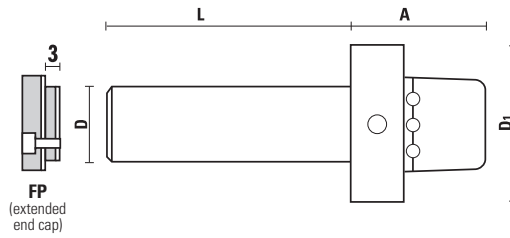

for: **Weinig Powerlock system**

Item	A	D	D1	L	End cap
T130.060.N	58	30	85	60	FP - Z092.002.R
T130.080.N	58	30	85	80	FP - Z092.002.R
T130.100.N	58	30	85	100	FP - Z092.002.R
T130.130.N	58	30	85	130	FP - Z092.002.R
T130.150.N	58	30	85	150	FP - Z092.002.R
T130.180.N	58	30	85	180	FP - Z092.002.R
T130.200.N	58	30	85	200	FP - Z092.002.R
T130.230.N	58	30	85	230	FP - Z092.002.R
T130.240.N	58	30	85	240	FP - Z092.002.R
T131.080.N	58	35	85	80	FP - Z092.004.R
T131.100.N	58	35	85	100	FP - Z092.004.R
T131.120.N	58	35	85	120	FP - Z092.004.R
T131.150.N	58	35	85	150	FP - Z092.004.R
T131.200.N	58	35	85	200	FP - Z092.004.R
T132.060.N	58	40	85	60	FP - Z092.006.R
T132.080.N	58	40	85	80	FP - Z092.006.R
T132.100.N	58	40	85	100	FP - Z092.006.R
T132.150.N	58	40	85	150	FP - Z092.006.R
T132.180.N	58	40	85	180	FP - Z092.006.R
T132.200.N	58	40	85	200	FP - Z092.006.R
T132.240.N	58	40	85	240	FP - Z092.006.R



Z051.016.R

CUTTER ARBORS WITH HSK85S TAPER

ART. T132

- Complete with end cap page 10.14

- Nr. 3 pin holes to 120°

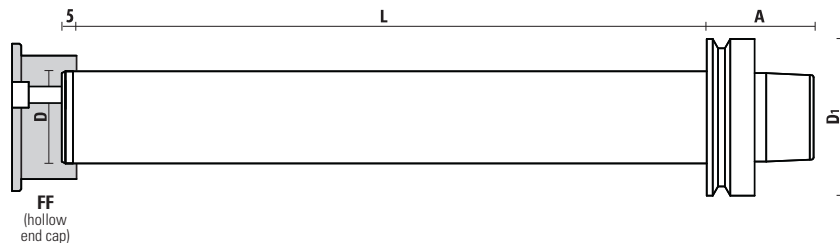

for: **SCM**

Item	A	D	D1	L	End cap
T132.320.NS NEW	58	50	85	320	FF - Z092.050.R



Z051.016.R

SPACERS 2-SIDES GRINDED

ART. YD300 - YD350 - YD400

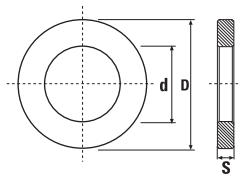
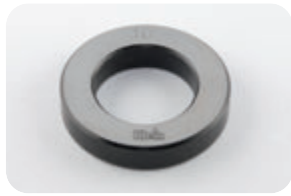

- For arbors Art. T128 - Art. T130 - Art. T131 - Art. T132
- Burnished
- Spacer rings fine-blanking processed for thickness 0,1±1 mm (tolerance ± 0,02)
- Spacer rings grinded on two sides for thickness 2±50 mm (tolerance ± 0,01)

Item	D	D1	S
YD300.001 NEW	30	50	0,1
YD300.002 NEW	30	50	0,2
YD300.005 NEW	30	50	0,5
YD300.010 NEW	30	50	1
YD300.020	30	50	2
YD300.030	30	50	3
YD300.040	30	50	4
YD300.050	30	50	5
YD300.060	30	50	6
YD300.080	30	50	8
YD300.100	30	50	10
YD300.120	30	50	12
YD300.150 NEW	30	50	15
YD300.200	30	50	20
YD300.250	30	50	25
YD300.300	30	50	30
YD300.400 NEW	30	50	40
YD300.500 NEW	30	50	50
YD350.001 NEW	35	55	0,1
YD350.002 NEW	35	55	0,2
YD350.005 NEW	35	55	0,5
YD350.010 NEW	35	55	1
YD350.020	35	55	2
YD350.030	35	55	3
YD350.040	35	55	4
YD350.050	35	55	5
YD350.060	35	55	6
YD350.080	35	55	8
YD350.100	35	55	10
YD350.120	35	55	12
YD350.150 NEW	35	55	15
YD350.200	35	55	20
YD350.250	35	55	25
YD350.300	35	55	30
YD350.400 NEW	35	55	40
YD350.500 NEW	35	55	50

Item	D	D1	S
YD400.001 NEW	40	60	0,1
YD400.002 NEW	40	60	0,2
YD400.005 NEW	40	60	0,5
YD400.010 NEW	40	60	1
YD400.020	40	60	2
YD400.030	40	60	3
YD400.040	40	60	4
YD400.050	40	60	5
YD400.060	40	60	6
YD400.080	40	60	8
YD400.100	40	60	10
YD400.120	40	60	12
YD400.150 NEW	40	60	15
YD400.200	40	60	20
YD400.250	40	60	25
YD400.300	40	60	30
YD400.400 NEW	40	60	40
YD400.500 NEW	40	60	50
YD500.001 NEW	50	70	0,1
YD500.002 NEW	50	70	0,2
YD500.005 NEW	50	70	0,5
YD500.010 NEW	50	70	1
YD500.020 NEW	50	70	2
YD500.030 NEW	50	70	3
YD500.040 NEW	50	70	4
YD500.050 NEW	50	70	5
YD500.060 NEW	50	70	6
YD500.080 NEW	50	70	8
YD500.100 NEW	50	70	10
YD500.120 NEW	50	70	12
YD500.150 NEW	50	70	15
YD500.200 NEW	50	70	20
YD500.250 NEW	50	70	25
YD500.300 NEW	50	70	30
YD500.400 NEW	50	70	40
YD500.500 NEW	50	70	50
YD600.001 NEW	60	80	0,1
YD600.002 NEW	60	80	0,2
YD600.005 NEW	60	80	0,5
YD600.010 NEW	60	80	1
YD600.020 NEW	60	80	2
YD600.030 NEW	60	80	3
YD600.040 NEW	60	80	4
YD600.050 NEW	60	80	5
YD600.060 NEW	60	80	6
YD600.080 NEW	60	80	8
YD600.100 NEW	60	80	10
YD600.120 NEW	60	80	12
YD600.150 NEW	60	80	15
YD600.200 NEW	60	80	20
YD600.250 NEW	60	80	25
YD600.300 NEW	60	80	30
YD600.400 NEW	60	80	40
YD600.500 NEW	60	80	50



SPACERS SET

ART. YD300 - YD350 - YD400 - YD500 - YD600

Item	D	D1
YD300.990	30	50
YD350.990	35	55
YD400.990	40	60
YD500.990 NEW	50	70
YD600.990 NEW	60	80

Complete with:

- nr. 4 sp. 2 mm - nr. 3 sp. 4 mm - nr. 2 sp. 5 mm
- nr. 2 sp. 10 mm - nr. 1 sp. 20 mm - nr. 1 sp. 30 mm

RETAINING PAWLS FOR CONCENTRIC CHUCK

ART. T118

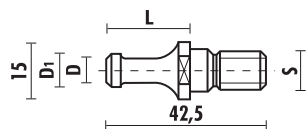

For: **Morbidelli, SCM**

Item		D1	D	L	S
T118.790.R	ISO 30	8,5	6,5	22	M10

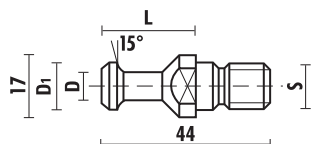

DIN 69872 for:
Busellato, Weeke, Ima, Bulleri, Maka, Cosmec, Reichenbacher, Elte

Item		D1	D2	D	L	LT	S
T118.791.R	ISO 30	13	17	9	24	44	M12
T118.893.R	ISO 40	19	23	14	26	54	M16

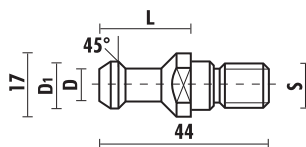

For: **Alberti, Vitap, Masterwood** (motor G. Colombo)

Item		D1	D	L	S
T118.792.R	ISO 30	12,8	9	24	M12

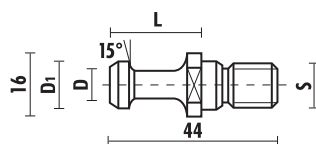

For: **Esseteam**

Item		D1	D	L	S
T118.793.R	ISO 30	12	8	24	M12

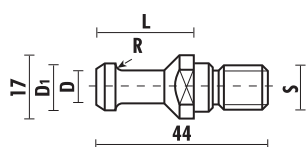

For: **CMS**

Item		D1	D	L	R	S
T118.794.R	ISO 30	12,8	9	24	2,4	M12

RETAINING PAWLS FOR CONCENTRIC CHUCK

ART. T118

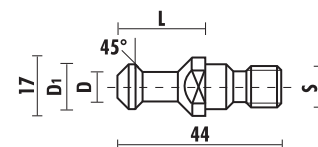

For: **Belotti**

Item		D1	D	L	S
T118.795.R	ISO 30	13	9	23	M12

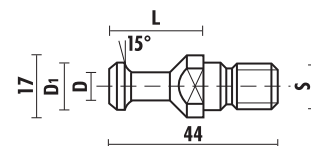

For: **Biesse** (until 9/9/92)

Item		D1	D	L	S
T118.890.R	ISO 30	13	9	24	M12

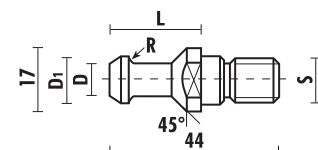

For: **Biesse** (after 9/9/92), **Masterwood** (motor H.S.D.), **Bulleri** and **Thermwood**

Item		D1	D	L	R	S
T118.891.R	ISO 30	12	8	24	3,2	M12

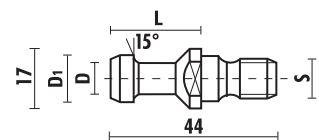

For: **Komo**

Item		D1	D	L	S
T118.894.R	BT 30	13	9	24	M12

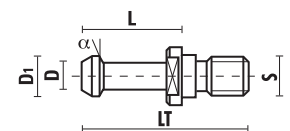

For: **BT 30 - BT 40 Shoda, BT 35 Heian**

Item		D1	D	L	LT	α	S
T118.895.R	BT 30	11	7	23,5	43	30°	M12
T118.896.R	BT 35	13	8,5	28	48	45°	M12
T118.897.R	BT 40	15	10	35	60	45°	M16

MACHINES AND TOOLS MAINTENANCE:

Coupling seats in the electrospindles, in the collet chucks or in the spring collets should be always clean and spotless in order to avoid a wrong position of the tool causing bad finishing results or even tool breakage.

By using regularly the tapers **Klein** these risks are reduced and the tool life span is highly increased.

CONE WIPERS

ART. T137



Drawing 1

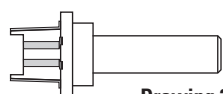

Drawing 2

- To maintain the inside of the cone clean
- To avoid wrong positioning of the cone and ensure best contact between tool and tool holder
- Suitable for all tool holder types

Item	Concentric chuck	Drawing
T137.002.N	Cono Morse 2 (MK2)	1
T137.003.N	Cono Morse 3 (MK3)	1
T137.030.N	ISO 30/BT 30	1
T137.040.N	ISO 40/BT 40	1
T137.163.N	HSK 63 A-C-E	2
T137.263.N	HSK 63 B-D-F	2

COLLET WIPERS

ART. T137

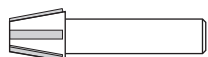

- To maintain the inside of the collet clean
- To avoid wrong positioning of the collet due to resin
- For all collet types

Item	Collet type
T137.525.N	ER 25-ETS 25-DIN6499
T137.532.N	ER 32-ETS 32-DIN6499
T137.540.N	ER 40-ETS 40-DIN6499
T137.662.N	EOC 25-DIN 6388

BRUSHES FOR COLLET BORE

ART. T137



- To clean the collet bore
- To avoid wrong tool positioning caused by resin

Item	Collet bore
T137.906.N	3÷6
T137.911.N	6,4÷11
T137.918.N	12÷18
T137.925.N	19÷25

X137.004.N Collet brush set 3÷25



WIPE OFF KIT

ART. X137

- For boring machines and CNC router machines
- Carton box



Item	Description
X137.000.N	HSK63F/ER32 T137.263.N + T137.532.N + X137.004.N
X137.001.N	ISO30/ER32 T137.030.N + T137.532.N + X137.004.N
X137.002.N	HSK63F/DIN6388 T137.263.N + T137.662.N + X137.004.N
X137.005.N	HSK63F/ER40 T137.263.N + T137.540.N + X137.004.N
X137.006.N	ISO30/ER40 T137.030.N + T137.540.N + X137.004.N

ADJUSTABLE DEMOUNT DEVICES

ART. T139

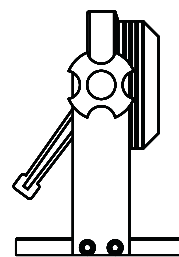
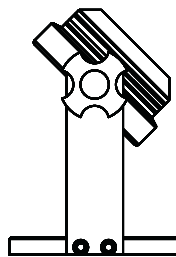
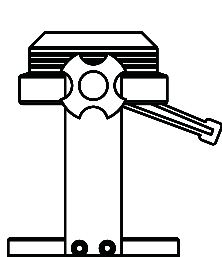

- Tool holder to be blocked on the flange diameter
- It is adjustable from 0° to 90°

Item	Machine
T139.150.N	For ISO 30 tool holder Ø 50 mm
T139.158.N	For ISO 30 tool holder Ø 58 (Motor ELTE/ESSETEAM)
T139.163.N	For HSK63 tool holder Ø 63
T139.164.N NEW	For ISO 40 tool holder Ø 63,5

DEMOUNT DEVICES FOR FLANGE Ø80 - Ø85

ART. T139

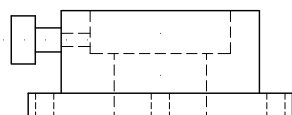

Tool holder to be blocked on the flange diameter

Item	Machine
T139.180.N NEW	For tool holder Ø 80 mm
T139.185.N	For tool holder Ø 85 mm (Weinig, SCM)

DEMOUNT DEVICES

ART. T139

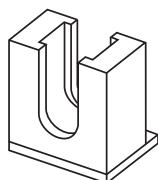

Suitable for toolholders with key seat 41 mm

Item	Machine
T139.000.N selling out	For HSK 63 F tool holder Ø 63
T139.003.N selling out	For ISO 40 tool holder Ø 63,5

ISO 30 DEMOUNT DEVICES

ART. T139

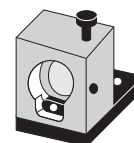

- For ISO30 special
- Horizontal and vertical type

Item	Machine
T139.001.N selling out	Morbidelli - SCM

PROFILE CUTTERS, GROUP 1

ART. T130

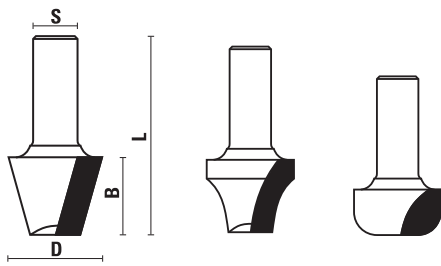

- HW and HS
- Z=2
- RH rotation

D	B
11÷20	20
11÷20	30
11÷20	40
11÷20	50
21÷30	20
21÷30	30
21÷30	40
21÷30	50
21÷30	60
31÷40	20
31÷40	30
31÷40	40
31÷40	50
31÷40	60
41÷50	20
41÷50	30
41÷50	40
41÷50	50
41÷50	60
51÷60	30
51÷60	40
51÷60	50
51÷60	60
61÷70	30
61÷70	40
61÷70	50
71÷80	30
71÷80	40
81÷90	30
81÷90	40
91÷100	30
91÷100	40
101÷120	30

Price depends on the diameter and length of the cutters.
For a specific quote a detailed drawing or a sample are required.

Insert router bits see page 9.09

PROFILE CUTTERS, GROUP 2

ART. T130

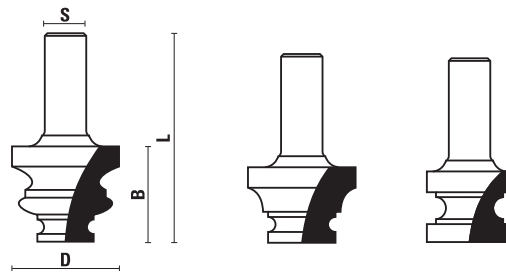

- HW and HS
- Z=2
- RH rotation

D	B
11÷20	20
11÷20	30
11÷20	40
11÷20	50
21÷30	20
21÷30	30
21÷30	40
21÷30	50
21÷30	60
31÷40	20
31÷40	30
31÷40	40
31÷40	50
31÷40	60
41÷50	20
41÷50	30
41÷50	40
41÷50	50
41÷50	60
51÷60	30
51÷60	40
51÷60	50
51÷60	60
61÷70	30
61÷70	40
61÷70	50
71÷80	30
71÷80	40
81÷90	30
81÷90	40
91÷100	30
91÷100	40
101÷120	30

Price depends on the diameter and length of the cutters.
For a specific quote a detailed drawing or a sample are required.

Insert router bits see page 9.09

SOLID CARBIDE ROUTER BITS:

Useful information:

Klein offers a very wide range of solid carbide router bits which can satisfy almost all exigencies by using a CNC machine.

TECHNICAL DATA:

• Tungsten-carbide (Widia): is the most suitable material to use on CNC machines assuring the best performances.

• FLUTE GEOMETRY:

- Up Cut style, for a better finish on the bottom of the material

Good finish on bottom side



- Down Cut Style, for a better finish on the top surface

Good finish on panel top side



- Compression Style, for a good finish on either top and bottom surface, particularly on laminated materials

Excellent finish on both upper and lower side

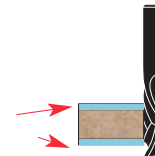

- NUMBER OF TEETH: **Z=1:** allow heavy duties on soft materials and an excellent chip evacuation
- Z=2:** allow a better finish on hard materials and a good chip evacuation
- Z=3:** allow an excellent finish on all types of materials
- Z=2/Z=3:** with chipbreaker, ideal for heavy duties

N.B.: Increasing the number of teeth should increase also the feed speed in order to preserve the tool from burning or early wearing out.

Minimum clamping tool length	
Shank diameter S (mm)	Minimum length K (mm)
S ≤ 10	K ≥ 20
10 < S < 25	K = S x 2
S ≥ 25	K = S x 1,8

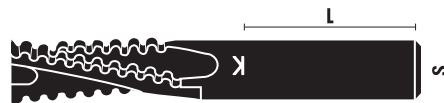

N.B.:

All **Klein** spiral router bits have technical data, dimensions and type of material marked on the shank. Moreover the sign **K** indicates the minimum clamping length according to the standard EN847-2

The following reference tables are provided just as a guide, while various other conditions must be always taken in consideration, such as the characteristics of the wood piece (humidity, veins, etc.), the machine and tooling conditions, etc.

HOW TO CHOSE THE RIGHT SOLID CARBIDE SPIRAL BIT FOR ROUTING ON A CNC MACHINE

Router Bits Klein	Softwood (Cider, Poplar, Pine, etc.)	Hardwood (Ash, Walnut, Beech, Oak, Teak, etc.)	Pressed Wood (Plywood, Blockboard)	Laminated Wood (Veneered, melamine coated panels, HPL, etc.)
T141/T151 - Z=1 - Page 7.38/7.42	XXX	XXX	X	-
T142/T152 - Z=2 - Page 7.39/7.43	XXX	XXX	X	XX
T143/T153 - Z=3 - Page 7.40/7.43	XX	XX	XXX	XXX
T144/T154 - Z=3 With chipbreaker Page 7.41/7.44	XXX	XXX	XXX	XX
T155 - Z=1+1 - Page 7.44	XX	XX	X	X
T156 - Z=2+2 - Page 7.45	X	XX	XXX	XXX
T170/T171 - Z=2 With chipbreaker Page 7.47	X	X	XX	XX

- X = Satisfactory
- XX = Good
- XXX = Excellent
- = not suggested

Technical data and images are just an indication. **SISTEMI** srl reserves the right to modify the above information at any time and without notice

REFERENCE TABLE FOR CALCULATING FEEDING RATES IN THE WOODWORKING

Reference table for calculating feeding rates (mt/min ⁻¹)					
DIAMETER	ITEM	SOFTWOOD	HARDWOOD	MDF	LAMINATED WOOD
Ø 3	T141	2,40	2,40	2,40	-
	T142	3,20	2,60	3,00	-
	T143	-	-	-	-
	T144	-	-	-	-
	T156	-	-	-	-
Ø 6	T141	3,70	3,60	3,40	-
	T142	4,00	3,70	3,90	-
	T143	-	-	-	-
	T144	-	-	-	-
	T156	-	-	-	-
Ø 8	T141	4,30	4,00	3,80	-
	T142	5,00	4,30	4,90	-
	T143	6,00	4,60	5,20	5,80
	T144	8,20	6,60	6,80	-
	T156	6,60	5,20	5,70	6,50
Ø 10	T141	4,90	4,90	3,80	-
	T142	6,20	4,60	5,40	-
	T143	7,30	5,00	6,10	6,80
	T144	9,10	6,60	7,40	-
	T156	6,70	5,10	6,00	6,60
Ø 12	T141	5,10	4,90	4,20	-
	T142	6,50	5,20	5,40	-
	T143	7,90	6,30	6,80	7,40
	T144	10,20	8,10	8,30	-
	T156	6,90	5,10	6,00	6,70
Ø 16	T141	-	-	-	-
	T142	7,70	6,10	6,90	-
	T143	9,50	7,90	8,10	9,10
	T144	11,80	9,00	9,50	-
	T156	7,30	6,00	6,30	6,80
Ø 20	T141	-	-	-	-
	T142	8,60	7,30	7,90	-
	T143	10,80	8,50	8,90	10,00
	T144	15,00	11,00	11,90	-
	T156	8,00	6,90	7,20	7,00

Technical data and images are just an indication. **SISTEMI** srl reserves the right to modify the above information at any time and without notice.

THE RECOMMENDED FEED RATES WERE CALCULATED TAKING IN CONSIDERATION THE FOLLOWING PARAMETERS:

- **efficient machinery** in excellent conditions;
- **wood piece** perfectly clamped;
- **working solid material** (if not, parameters can be increased)
- **wood piece dry;**
- RPM 18.000 (working at a different rotation speed the feed rate should change accordingly)
- cutting depth two times the router bit diameter (the feed rate increases by 25% when the cutting depth is like the tool diameter – the feed rate decreases by 25% when the cutting depth is three times the tool diameter)
- router bits up flute style
- better use down cut router bits if the vacuum clamping is not strong enough
- using down cut style bits we suggest a maximum cutting depth like the half of the tool diameter, otherwise there is not enough chip flow

SISTEMI suggest:

for working softwood

	Good	Excellent
Single pass	T155+T141/T151	T142/T152
Roughing	T144/T154	T144/T154
Finishing	T142/T152	T143/T153

for working hardwood

	Good	Excellent
Single pass	T142/T152	T142/T152
Roughing	T144/T154	T144/T154
Finishing	T142/T152	T143/T153

for working MDF

	Good	Excellent
Single pass	T142	T145
Roughing	T170	T144
Finishing	T145	T143

for working laminated and veneered chipboard

	Good	Excellent
Single pass	T156	T156

for working hard plastic (nylon, corian®, acrylic)

	Good	Excellent
Single pass	T141	T142
Roughing	T170	T144
Finishing	T156/T142	T156/T142

SOLID CARBIDE SPIRAL CUTTERS, FINISH STYLE Z=1

ART. T141

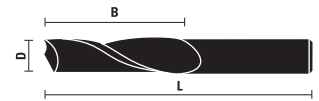

- Right-hand rotation with "UP CUT SPIRAL"

- To be used on machining centres, CNC routers and point to point machines

RH rotation	D	B	L	Z
T141.030.R	3	12	50	1
T141.040.R	4	12	50	1
T141.050.R	5	17	50	1
T141.060.R	6	17	60	1
T141.061.R	6	27	60	1
T141.064.R	6,4	28	60	1
T141.080.R	8	22	80	1
T141.081.R	8	32	80	1
T141.100.R	10	32	80	1
T141.101.R	10	42	100	1
T141.120.R	12	32	80	1
T141.121.R	12	42	100	1

Router bits with diameter from 12 mm, are produced with shank for Seeger retaining rings



SOLID CARBIDE SPIRAL CUTTERS, FINISH STYLE Z=1

ART. T141

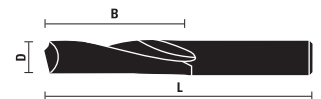

Good finish on panel top side

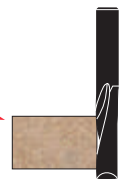

- Left-hand rotation with "DOWN CUT SPIRAL"

- To be used on machining centres, CNC routers and point to point machines

LH rotation	D	B	L	Z
T141.061.L	6	27	60	1
T141.080.L	8	22	80	1
T141.081.L	8	32	80	1
T141.100.L	10	32	100	1

SOLID CARBIDE SPIRAL CUTTERS, FINISH STYLE Z=2

ART. T142

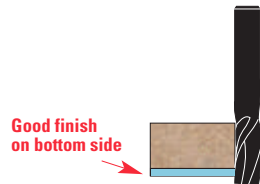
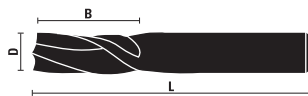

- Right-hand rotation with "UP CUT SPIRAL"

- To be used on machining centres, CNC routers and point to point machines

RH rotation	D	B	L	Z
T142.030.R	3	12	50	2
T142.040.R	4	12	50	2
T142.050.R	5	17	50	2
T142.060.R	6	17	60	2
T142.061.R	6	27	60	2
T142.080.R	8	22	80	2
T142.081.R	8	35	80	2
T142.100.R	10	35	80	2
T142.101.R	10	45	100	2
T142.110.R	11	35	80	2
T142.111.R	11	45	100	2
T142.120.R	12	35	80	2
T142.121.R	12	45	100	2
T142.122.R	12	55	100	2
T142.140.R	14	45	100	2
T142.141.R	14	55	100	2
T142.142.R	14	80	140	2
T142.160.R	16	45	100	2
T142.161.R	16	55	100	2
T142.162.R	16	72	120	2
T142.180.R	18	55	100	2
T142.181.R	18	72	120	2
T142.182.R	18	102	150	2
T142.200.R	20	55	100	2
T142.201.R	20	72	120	2
T142.202.R	20	102	150	2

Router bits with diameter from 12 mm to 20 mm, are produced with shank for Seeger retaining rings



SOLID CARBIDE SPIRAL CUTTERS, FINISH STYLE Z=2

ART. T142

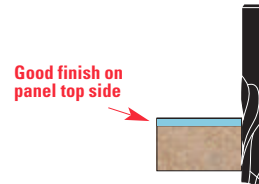
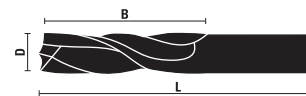

- Left-hand rotation with "DOWN CUT SPIRAL"

- To be used on machining centres, CNC routers and point to point machines

LH rotation	D	B	L	Z
T142.030.L	3	12	50	2
T142.040.L	4	12	50	2
T142.060.L	6	17	60	2
T142.081.L	8	35	80	2
T142.100.L	10	35	80	2
T142.120.L	12	35	90	2
T142.140.L	14	45	100	2
T142.160.L	16	45	100	2
T142.161.L	16	55	100	2
T142.180.L	18	55	115	2
T142.182.L	18	102	165	2
T142.200.L	20	55	120	2

Router bits with diameter from 12 mm to 20 mm, are produced with shank for Seeger retaining rings



HOW TO DETERMINE THE FEEDING SPEED RELATING TO THE DIAMETER:

- Referring to item T142 with right hand rotation (UP CUT STYLE), Z=2
- RPM 18.000

Hard wood

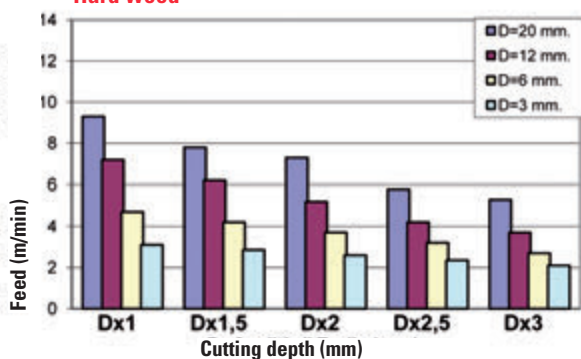

Soft wood

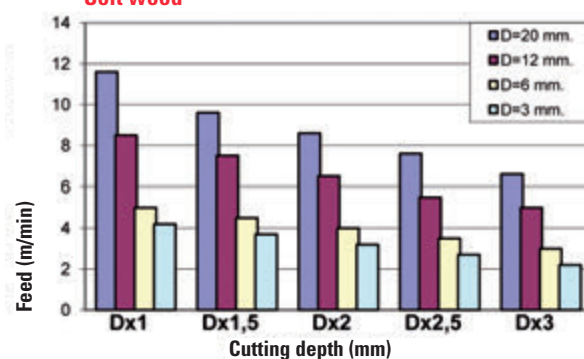

SOLID CARBIDE SPIRAL CUTTERS, FINISH STYLE Z=3

ART. T143

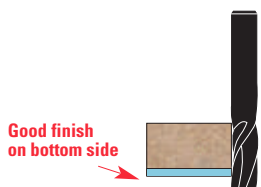
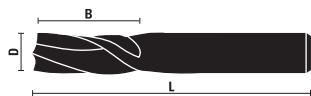

- Right-hand rotation with "UP CUT SPIRAL"
 - To be used on machining centres, CNC routers and point to point machines

RH rotation	D	B	L	Z
T143.080.R	8	22	80	3
T143.081.R	8	35	80	3
T143.100.R	10	35	80	3
T143.101.R	10	45	100	3
T143.120.R	12	35	80	3
T143.121.R	12	45	100	3
T143.122.R	12	55	100	3
T143.140.R	14	45	100	3
T143.141.R	14	55	100	3
T143.160.R	16	45	100	3
T143.161.R	16	55	100	3
T143.162.R	16	72	120	3
T143.180.R	18	55	100	3
T143.181.R	18	72	120	3
T143.182.R	18	102	150	3
T143.200.R	20	55	100	3
T143.201.R	20	72	120	3
T143.202.R	20	102	150	3
T143.250.R	25	102	150	3

Router bits with diameter from 12 mm to 25 mm, are produced with shank for Seeger retaining rings



SOLID CARBIDE SPIRAL CUTTERS, FINISH STYLE Z=3

ART. T143

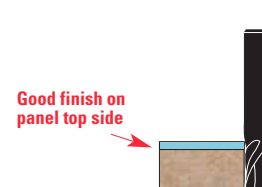
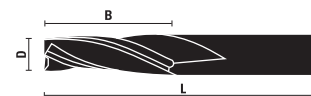

- Left-hand rotation with "DOWN CUT SPIRAL"
 - To be used on machining centres, CNC routers and point to point machines

LH rotation	D	B	L	Z
T143.081.L	8	35	80	3
T143.101.L	10	45	100	3
T143.120.L	12	35	85	3
T143.160.L	16	45	100	3
T143.180.L	18	55	115	3
T143.200.L	20	55	115	3
T143.201.L	20	72	130	3

Router bits with diameter from 12 mm to 20 mm, are produced with shank for Seeger retaining rings



THREE POINT DIGITAL CALIPER

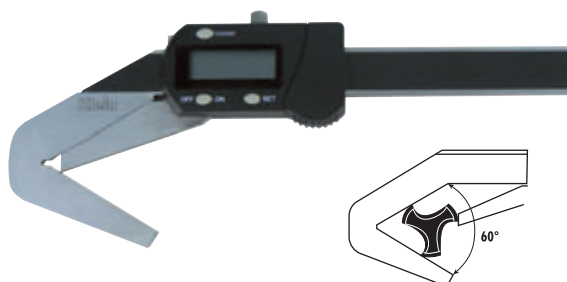

See page 15.03 for further information

HOW TO DETERMINE THE FEEDING SPEED RELATING TO THE DIAMETER:

- Referring to item T143 with right hand rotation (UP CUT STYLE), Z=3
 - RPM 18.000

Hard wood

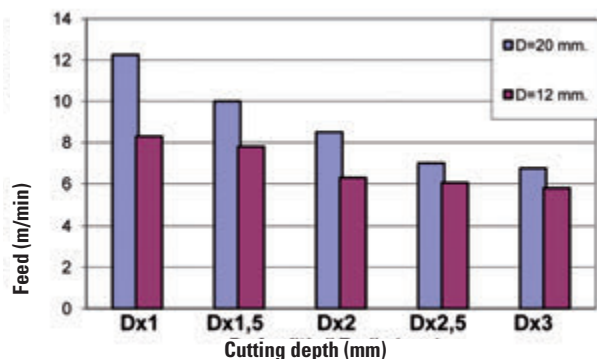

Soft wood

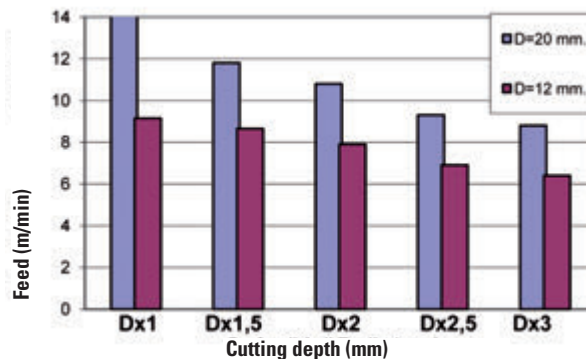

**SOLID CARBIDE SPIRAL CUTTERS,
ROUGHING STYLE Z=3**

ART. T144

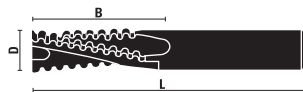

- Right-hand rotation with "UP-CUT STYLE"
- Chip-breaker execution
- To be used on machining centres, CNC routers and point to point machines
- Suitable for roughing, they guarantee a high feed rate

RH rotation	D	B	L	Z
T144.080.R	8	22	80	3
T144.081.R	8	35	80	3
T144.100.R	10	35	80	3
T144.101.R	10	45	100	3
T144.120.R	12	35	80	3
T144.121.R	12	45	100	3
T144.122.R	12	55	100	3
T144.123.R	12	42	90	3
T144.140.R	14	45	100	3
T144.141.R	14	55	100	3
T144.142.R	14	58	110	3
T144.160.R	16	45	100	3
T144.161.R	16	55	100	3
T144.162.R	16	72	120	3
T144.163.R	16	62	110	3
T144.180.R	18	55	100	3
T144.181.R	18	72	120	3
T144.182.R	18	102	150	3
T144.200.R	20	55	100	3
T144.201.R	20	72	120	3
T144.202.R	20	102	150	3
T144.250.R	25	102	150	3

**SOLID CARBIDE SPIRAL CUTTERS,
ROUGHING STYLE Z=3**

ART. T144

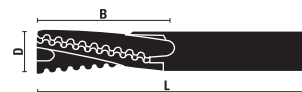

- Left-hand rotation with "DOWN-CUT STYLE"
- Chip-breaker execution
- To be used on machining centres, CNC routers and point to point machines
- Suitable for roughing, they guarantee a high feed rate

LH rotation	D	B	L	Z
T144.081.L	8	35	80	3
T144.100.L	10	35	80	3
T144.121.L	12	45	100	3
T144.122.L	12	55	105	3
T144.141.L	14	55	110	3
T144.160.L	16	45	100	3
T144.161.L	16	55	110	3
T144.162.L	16	72	125	3
T144.180.L	18	55	115	3
T144.200.L	20	55	115	3

Router bits with diameter from 12 mm to 20 mm, are produced with shank for Seeger retaining rings



Router bits with diameter from 12 mm to 25 mm, are produced with shank for Seeger retaining rings



**HOW TO DETERMINE THE FEEDING SPEED
RELATING TO THE DIAMETER:**

- Referring to item T144 with right hand rotation (UP CUT STYLE), Z=3
- RPM 18.000

Hard wood

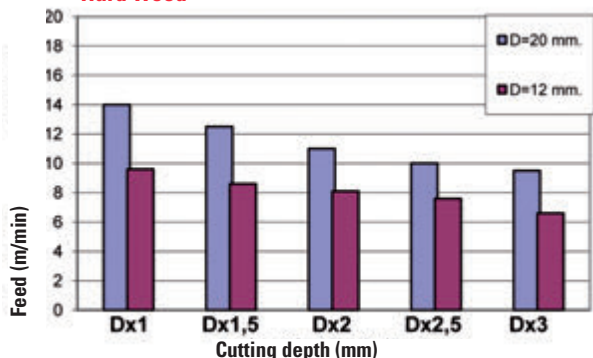

Soft wood

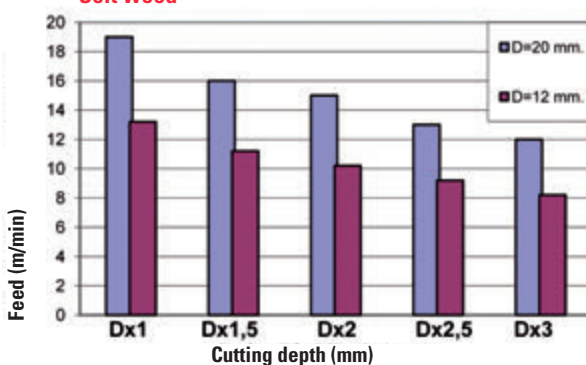

MDF

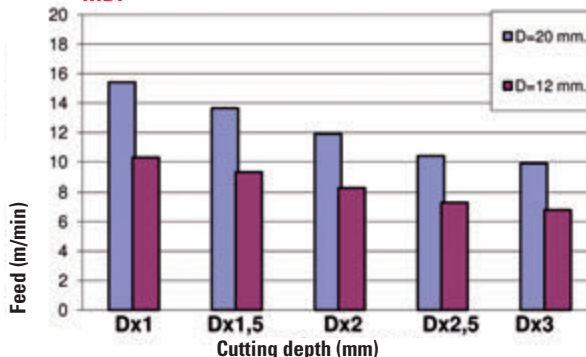

SOLID CARBIDE SPIRAL CUTTERS Z=3

ART. T146 - T147

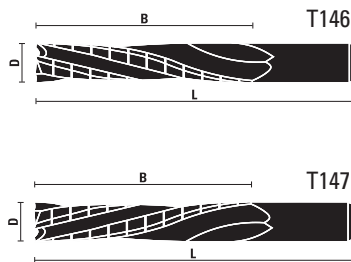

- Right-hand rotation with "UP CUT SPIRAL" (art. T146)
- Left-hand rotation with "UP CUT SPIRAL" (art. T147)
- Discontinuous cutting edge
- To be used on machining centres, CNC routers and point to point machines

RH rotation	D	B	L	Z
T146.250.R NEW	25	140	200	3

LH rotation	D	B	L	Z
T147.250.L NEW	25	140	200	3

Router bits with diameter from 25 mm, are produced with shank for Seeger retaining rings



THREE POINT DIGITAL CALIPER

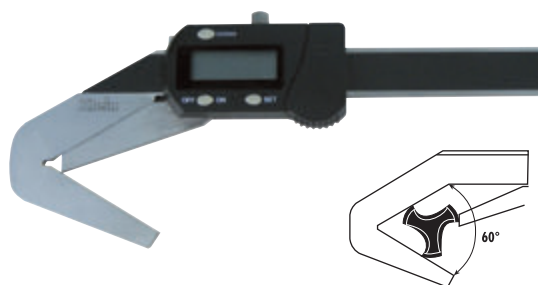

See page 15.03 for further information

SOLID CARBIDE SPIRAL CUTTERS, FINISH STYLE Z=1

ART. T151

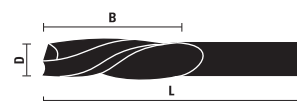

- Right-hand rotation with "DOWN CUT SPIRAL"
- To be used on machining centres, CNC routers and point to point machines

RH rotation	D	B	L	Z
T151.030.R	3	12	50	1
T151.040.R	4	12	50	1
T151.050.R	5	17	50	1
T151.060.R	6	17	70	1
T151.061.R	6	27	70	1
T151.080.R	8	22	80	1
T151.081.R	8	32	80	1
T151.100.R	10	32	80	1
T151.101.R	10	42	100	1
T151.120.R	12	32	90	1
T151.121.R	12	42	100	1
T151.122.R	12	52	110	1

Router bits with diameter from 12 mm to 20 mm, are produced with shank for Seeger retaining rings



SOLID CARBIDE SPIRAL CUTTERS, FINISH STYLE Z=1

ART. T151

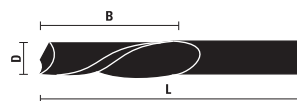

- Left-hand rotation with "UP CUT SPIRAL"
- To be used on machining centres, CNC routers and point to point machines

LH rotation	D	B	L	Z
T151.040.L	4	12	50	1
T151.061.L	6	27	60	1

SOLID CARBIDE SPIRAL CUTTERS, FINISH STYLE Z=2

ART. T152

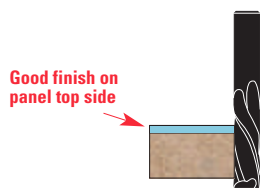

- Right-hand rotation with "DOWN CUT SPIRAL"

- To be used on machining centres, CNC routers and point to point machines

RH rotation	D	B	L	Z
T152.030.R	3	12	50	2
T152.040.R	4	12	50	2
T152.050.R	5	17	50	2
T152.060.R	6	17	70	2
T152.061.R	6	27	70	2
T152.080.R	8	22	80	2
T152.081.R	8	35	80	2
T152.100.R	10	35	80	2
T152.101.R	10	45	100	2
T152.110.R	11	35	80	2
T152.111.R	11	45	100	2
T152.120.R	12	35	90	2
T152.121.R	12	45	100	2
T152.122.R	12	55	110	2
T152.141.R	14	55	110	2
T152.160.R	16	45	100	2
T152.161.R	16	55	110	2
T152.180.R	18	55	115	2
T152.181.R	18	72	130	2
T152.200.R	20	55	115	2
T152.201.R	20	72	130	2

SOLID CARBIDE SPIRAL CUTTERS, FINISH STYLE Z=2

ART. T152

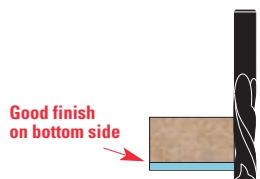
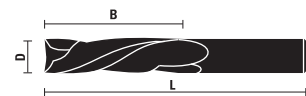

- Left-hand rotation with "UP CUT SPIRAL"

- To be used on machining centres, CNC routers and point to point machines

LH rotation	D	B	L	Z
T152.040.L	4	12	50	2
T152.060.L	6	17	60	2
T152.061.L	6	27	60	2
T152.080.L	8	22	80	2
T152.100.L	10	35	80	2
T152.120.L	12	35	80	2
T152.121.L	12	45	100	2
T152.141.L	14	55	110	2
T152.161.L	16	55	110	2
T152.181.L	18	72	120	2
T152.200.L	20	55	100	2
T152.201.L	20	72	120	2

Router bits with diameter from 12 mm to 20 mm, are produced with shank for Seeger retaining rings



SOLID CARBIDE SPIRAL CUTTERS, FINISH STYLE Z=3

ART. T153

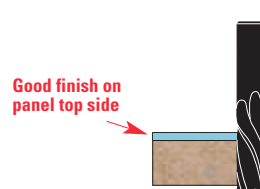

- Right-hand rotation with "DOWN CUT SPIRAL"

- To be used on machining centres, CNC routers and point to point machines

RH rotation	D	B	L	Z
T153.081.R	8	35	80	3
T153.100.R	10	35	80	3
T153.101.R	10	45	100	3
T153.120.R	12	35	85	3
T153.122.R	12	55	105	3
T153.140.R	14	45	100	3
T153.160.R	16	45	100	3
T153.161.R	16	55	110	3
T153.162.R	16	72	125	3
T153.180.R	18	55	115	3
T153.181.R	18	72	130	3
T153.200.R	20	55	115	3
T153.201.R	20	72	130	3

Router bits with diameter from 12 mm to 20 mm, are produced with shank for Seeger retaining rings



SOLID CARBIDE SPIRAL CUTTERS, FINISH STYLE Z=3

ART. T153

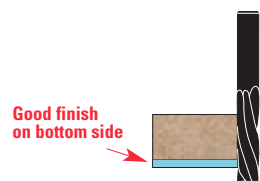
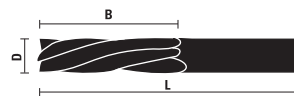

- Left-hand rotation with "UP CUT SPIRAL"

- To be used on machining centres, CNC routers and point to point machines

LH rotation	D	B	L	Z
T153.081.L	8	35	80	3
T153.100.L	10	35	80	3
T153.101.L	10	45	100	3
T153.120.L	12	35	80	3
T153.122.L	12	55	100	3
T153.140.L	14	45	100	3
T153.160.L	16	45	100	3
T153.161.L	16	55	100	3
T153.200.L	20	55	100	3
T153.201.L	20	72	120	3

Router bits with diameter from 12 mm to 20 mm, are produced with shank for Seeger retaining rings



SOLID CARBIDE SPIRAL CUTTERS, ROUGHING STYLE Z=3

ART. T154

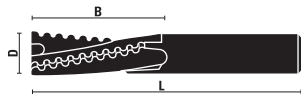

- Right-hand rotation with "DOWN CUT SPIRAL"
- Chip-breaker execution
- To be used on machining centres, CNC routers and point to point machines
- Suitable for roughing, they guarantee a high feed rate

RH rotation	D	B	L	Z
T154.080.R	8	22	80	3
T154.081.R	8	35	80	3
T154.100.R	10	35	80	3
T154.101.R	10	45	100	3
T154.120.R	12	35	83	3
T154.121.R	12	45	100	3
T154.122.R	12	55	105	3
T154.140.R	14	45	100	3
T154.160.R	16	45	100	3
T154.161.R	16	55	110	3
T154.162.R	16	72	125	3
T154.180.R	18	55	115	3
T154.181.R	18	72	130	3
T154.200.R	20	55	115	3
T154.201.R	20	72	130	3
T154.202.R	20	102	160	3

Router bits with diameter from 12 mm to 20 mm, are produced with shank for Seeger retaining rings 

SOLID CARBIDE SPIRAL CUTTERS, ROUGHING STYLE Z=3

ART. T154



- Left-hand rotation with "UP CUT SPIRAL"
- Chip-breaker execution
- To be used on machining centres, CNC routers and point to point machines
- Suitable for roughing, they guarantee a high feed rate

LH rotation	D	B	L	Z
T154.081.L	8	35	80	3
T154.100.L	10	35	80	3
T154.120.L	12	35	80	3
T154.122.L	12	55	100	3
T154.140.L	14	45	100	3
T154.160.L	16	45	100	3
T154.161.L	16	55	100	3
T154.180.L	18	55	100	3
T154.200.L	20	55	100	3
T154.201.L	20	72	120	3
T154.250.L NEW	25	155	220	3

Router bits with diameter from 12 mm to 25 mm, are produced with shank for Seeger retaining rings 

SOLID CARBIDE COMPRESSION CUTTERS Z=1+1

ART. T155

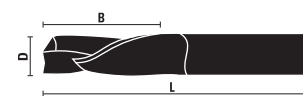

Excellent finish on both upper and lower side 

- Right-hand rotation with double flute, compression spiral
- To be used on machining centres, CNC routers and point to point machines

RH rotation	D	B	L	Z
T155.061.R	6	27	60	1+1
T155.080.R	8	22	80	1+1
T155.081.R	8	32	80	1+1
T155.100.R	10	32	80	1+1
T155.101.R	10	42	100	1+1
T155.120.R	12	42	100	1+1
T155.121.R	12	52	100	1+1
T155.127.R	12,7	32	78	1+1
T155.161.R	16	52	100	1+1

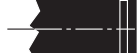
Router bits with diameter from 12 mm to 16 mm, are produced with shank for Seeger retaining rings 

SOLID CARBIDE COMPRESSION CUTTERS Z=1+1

ART. T155

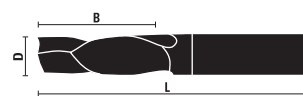

Excellent finish on both upper and lower side 

- Right-hand rotation with double flute, compression spiral
- To be used on machining centres, CNC routers and point to point machines

LH rotation	D	B	L	Z
T155.061.L	6	27	60	1+1
T155.081.L	8	32	80	1+1
T155.100.L	10	32	80	1+1
T155.120.L	12	42	100	1+1

Router bits with diameter from 12 mm, are produced with shank for Seeger retaining rings 

SOLID CARBIDE COMPRESSION CUTTERS Z=2+2

ART. T156

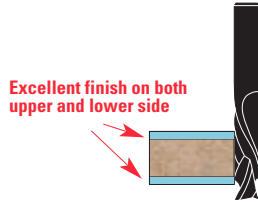
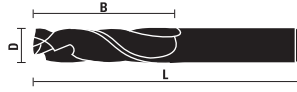

- Left-hand rotation with double flute, compression spiral
- To be used on machining centres, CNC routers and point to point machines

RH rotation	D	B	L	Z
T156.080.L	8	22	80	2+2
T156.081.L	8	32	80	2+2
T156.101.L	10	42	100	2+2
T156.120.L	12	42	100	2+2
T156.121.L	12	52	105	2+2
T156.161.L	16	52	110	2+2
T156.180.L	18	52	115	2+2
T156.200.L	20	52	115	2+2
T156.201.L	20	72	135	2+2

Router bits with diameter from 12 mm to 20 mm, are produced with shank for Seeger retaining rings



SOLID CARBIDE COMPRESSION CUTTERS Z=2+2

ART. T156

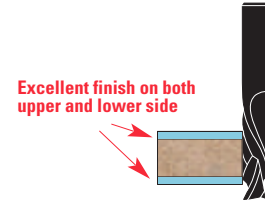
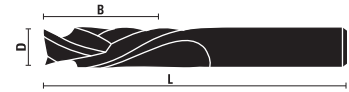

- Right-hand rotation with double flute, compression spiral
- To be used on machining centres, CNC routers and point to point machines

RH rotation	D	B	L	Z
T156.080.R	8	22	80	2+2
T156.081.R	8	32	80	2+2
T156.100.R	10	32	80	2+2
T156.101.R	10	42	100	2+2
T156.120.R	12	42	100	2+2
T156.121.R	12	52	110	2+2
T156.127.R	12,7	32	78	2+2
T156.140.R	14	42	100	2+2
T156.141.R	14	52	110	2+2
T156.160.R	16	42	100	2+2
T156.161.R	16	52	110	2+2
T156.162.R	16	72	130	2+2
T156.180.R	18	52	115	2+2
T156.181.R	18	72	135	2+2
T156.182.R	18	102	165	2+2
T156.200.R	20	52	115	2+2
T156.201.R	20	72	135	2+2

Router bits with diameter from 12 mm to 20 mm, are produced with shank for Seeger retaining rings



HOW TO DETERMINE THE FEEDING SPEED RELATING TO THE DIAMETER:

- Referring to item T156 with double flute, compression spiral, Z=2+2.
- RPM 18.000

Hard wood

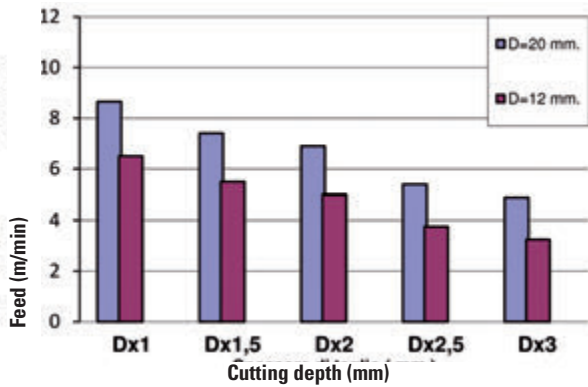

Soft wood

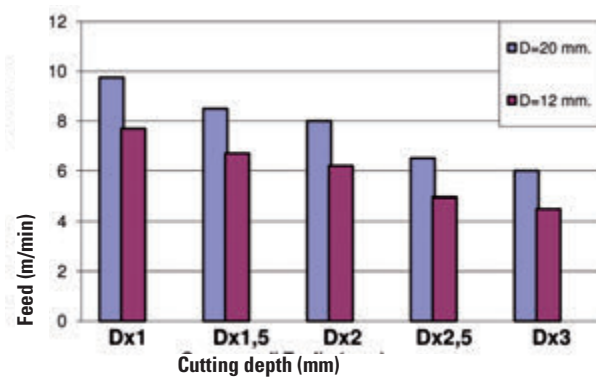

SOLID CARBIDE SPIRAL CUTTERS Z=2 - Z=3

ART. T157

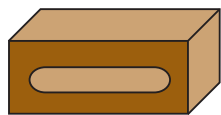

- Right-hand rotation with "UP CUT SPIRAL"
- Chip-breaker execution
- For locks and slot mortising

RH rotation	D	B1	B	L	S	Z
T157.140.R	14	20	95	155	14x45	2
T157.141.R	14	45	95	150	14x45	3
T157.160.R	16	25	115	175	16x45	2
T157.161.R	16	45	95	140	16x45	2
T157.162.R	16	50	100	150	16x45	3
T157.180.R	18	25	115	175	18x45	2
T157.181.R	18	50	100	150	18x45	3

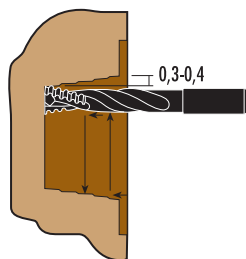

USE EXAMPLE

- Z=2/Z=3
- D= 14÷18 mm: RPM 12.000-20.000
- Stepwise processing 0,3-0,4 mm
- Can work deeply and have excellent chip evacuation

Router bits with diameter from 14 mm to 18 mm, are produced with shank for Seeger retaining rings



SOLID CARBIDE SPIRAL CUTTERS Z=3 FOR LOCKS

ART. T177 - T178

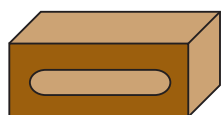

- Without chip-breaker
- For locks and slot mortising
- T177.160.R right rotation and right hand twist (positive/up cut style)
- T177.160.L left rotation and left hand twist (positive/up cut style)
- T178.160.R right rotation and left hand twist (negative/down cut style)

RH rotation	LH rotation	D	B1	B	L	S	Z
T177.160.R	T177.160.L	16	50	100	150	16x45	3
T178.160.R		16	50	100	150	16x45	3

Router bits with diameter from 16 mm, are produced with shank for Seeger retaining rings



SOLID CARBIDE SPIRAL CUTTERS Z=2

ART. T158

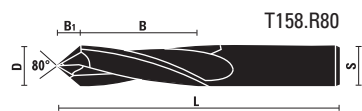
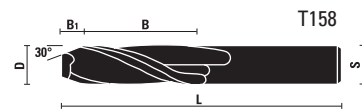

- Right-hand rotation with "UP CUT SPIRAL"
- For spy holes
- For boring and routing

RH rotation	D	B1	B	L	S	Z
T158.140.R	14	8	42	100	14	2
T158.160.R	16	9	52	120	16	2
T158.180.R	18	10	52	120	18	2
T158.200.R	20	11	52	120	20	2
T158.080.R80 NEW	8	4,8	38	80	8	2
T158.100.R80 NEW	10	6	46	100	10	2
T158.120.R80 NEW	12	7,2	50	110	12	2
T158.160.R80 NEW	16	9,6	52	120	16	2

Router bits with diameter from 12 mm to 20 mm, are produced with shank for Seeger retaining rings



SOLID CARBIDE SPIRAL CUTTERS Z=2

ART. T159

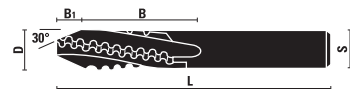

- Right-hand rotation with "UP CUT SPIRAL"
- Chip-breaker execution
- For spyholes on doors
- Through holes cutting

RH rotation	D	B1	B	L	S	Z
T159.160.R	16	9	52	120	16	2
T159.200.R	20	11	52	120	20	2

Router bits with diameter from 16 mm to 20 mm, are produced with shank for Seeger retaining rings



SOLID CARBIDE SPIRAL CUTTERS, FINISH STYLE S=6 Z=2

ART. T160



- Can also be used on portable routers
- Right-hand rotation with "UP CUT SPIRAL"

RH rotation	D	B	L	S	Z
T160.030.R	3	12	60	6	2
T160.035.R	3,5	14	60	6	2
T160.040.R	4	14	60	6	2
T160.045.R	4,5	16	60	6	2
T160.050.R	5	17	60	6	2

SOLID CARBIDE SPIRAL CUTTERS, FINISH STYLE S=6 Z=2

ART. T161

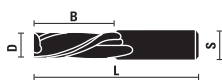

- Can also be used on portable routers
- Right-hand rotation with "DOWN CUT SPIRAL"

RH rotation	D	B	L	S	Z
T161.030.R	3	12	60	6	2
T161.035.R	3,5	14	60	6	2
T161.040.R	4	14	60	6	2
T161.045.R	4,5	16	60	6	2
T161.050.R	5	17	60	6	2

SOLID CARBIDE SPIRAL CUTTERS, FINISH STYLE S=8 Z=2

ART. T162



- Can also be used on portable routers
- Right-hand rotation with "UP CUT SPIRAL"

RH rotation	D	B	L	S	Z
T162.030.R	3	12	60	8	2
T162.040.R	4	14	60	8	2
T162.050.R	5	17	60	8	2
T162.060.R	6	22	70	8	2
T162.070.R	7	32	80	8	2

SOLID CARBIDE SPIRAL CUTTERS, FINISH STYLE S=8 Z=2

ART. T163

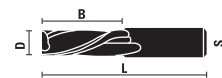

- Can also be used on portable routers
- Right-hand rotation with "DOWN CUT SPIRAL"

RH rotation	D	B	L	S	Z
T163.030.R	3	12	60	8	2
T163.040.R	4	14	60	8	2
T163.050.R	5	17	60	8	2
T163.060.R	6	22	70	8	2
T163.070.R	7	32	80	8	2

SOLID CARBIDE SPIRAL CUTTERS, ROUGHING STYLE Z=2

ART. T170



- Right-hand rotation with "UP CUT SPIRAL"
- Chip-breaker execution
- Z= 2 for the best chip removal

RH rotation	D	B	L	S	Z
T170.080.R	8	35	80	8	2
T170.100.R	10	35	80	10	2
T170.120.R	12	35	80	12	2
T170.121.R	12	45	90	12	2

Router bits with diameter from 12 mm, are produced with shank for Seeger retaining rings



SOLID CARBIDE SPIRAL CUTTERS, ROUGHING STYLE Z=2

ART. T171



- Right-hand rotation with "DOWN CUT SPIRAL"
- Chip-breaker execution
- Z= 2 for the best chip removal

RH rotation	D	B	L	S	Z
T171.080.R	8	35	80	8	2
T171.100.R	10	35	80	10	2
T171.120.R	12	35	80	12	2

Router bits with diameter from 12 mm, are produced with shank for Seeger retaining rings



SOLID CARBIDE SPIRAL CUTTERS RADIUS STYLE Z=2

ART. T175

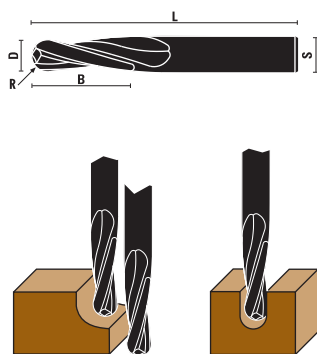

- Suitable for working plastic materials
- Right-hand rotation with "UP CUT SPIRAL"

RH rotation	D	R	B	L	Z
T175.030.R NEW	3	1,5	12	50	2
T175.040.R NEW	4	2	12	50	2
T175.060.R NEW	6	3	22	60	2
T175.080.R NEW	8	4	22	80	2
T175.100.R NEW	10	5	35	80	2
T175.120.R NEW	12	6	35	80	2
T175.160.R NEW	16	8	55	100	2
T175.180.R NEW	18	9	55	100	2
T175.200.R NEW	20	10	55	100	2

Router bits with diameter from 12 mm, are produced with shank for Seeger retaining rings



HS ROUTER BITS FOR "HUNDEGGER" MACHINES

ART. T244

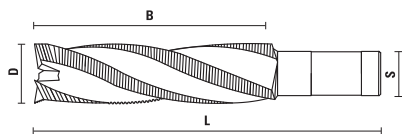

- Chip-breaker execution
- For machining lamellar beams

RH rotation	D	B	L	S	Z
T244.400.R	40	165	235	30	3
T244.500.R	50	215	295	30	3

HS CARVING BITS, PLANE STYLE

ART. T213 - T214

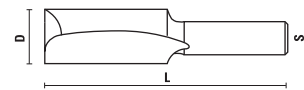

RH rotation	LH rotation	D	L	S	Z
T213.020.R	T213.020.L	2	90	11x50	1
T213.040.R	T213.040.L	4	90	11x50	1
T213.060.R	T213.060.L	6	90	11x50	1
T213.080.R	T213.080.L	8	90	11x50	1
T213.100.R	T213.100.L	10	90	11x50	1
T213.120.R	T213.120.L	12	90	11x50	1
T213.140.R	T213.140.L	14	90	11x50	1
T213.160.R	T213.160.L	16	90	11x50	1

T214.100.R	T214.100.L	10	90	11x50	2
T214.120.R	T214.120.L	12	90	11x50	2
T214.140.R	T214.140.L	14	90	11x50	2
T214.160.R	T214.160.L	16	90	11x50	2
T214.180.R	T214.180.L	18	90	11x50	2
T214.200.R	T214.200.L	20	90	11x50	2
T214.220.R	T214.220.L	22	90	11x50	2
T214.240.R	T214.240.L	24	90	11x50	2

HS CARVING BITS, ROUND STYLE

ART. T215 - T216

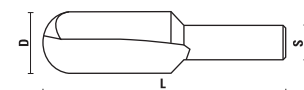

RH rotation	LH rotation	D	L	S	Z
T215.020.R	T215.020.L	2	90	11x50	1
T215.040.R	T215.040.L	4	90	11x50	1
T215.060.R	T215.060.L	6	90	11x50	1
T215.080.R	T215.080.L	8	90	11x50	1
T215.100.R	T215.100.L	10	90	11x50	1
T215.120.R	T215.120.L	12	90	11x50	1
T215.140.R	T215.140.L	14	90	11x50	1
T215.160.R	T215.160.L	16	90	11x50	1

T216.100.R	T216.100.L	10	90	11x50	2
T216.120.R	T216.120.L	12	90	11x50	2
T216.140.R	T216.140.L	14	90	11x50	2
T216.160.R	T216.160.L	16	90	11x50	2
T216.180.R	T216.180.L	18	90	11x50	2
T216.200.R	T216.200.L	20	90	11x50	2
T216.220.R	T216.220.L	22	90	11x50	2
T216.240.R	T216.240.L	24	90	11x50	2

KleinDIA

A surface treatment developed for large-scale production

KleinDIA is a DLC (**Diamond-like Carbon**) anti-friction coating which allows to solve problems of tool abrasion, chip evacuation and chemical attack.

A layer of approx. 1 micron is laid on the tool surface at low temperature, thus not altering the properties of the router bit or knife. Its high hardness is granted by both Sp2 (**Graphite**) and Sp3 (**Diamond**) carbon hybridisation.

Our several tests confirmed remarkable results on both panel working and solid wood processing.

Working plastic and aluminium without coolant is also possible thanks to a very low friction coefficient.

TECHNICAL FEATURES:

- **High hardness** Hv0,025: 2500-3100
- **Higher wear resistance** (longer working time)
- **Low frictional coefficient** (lowered working temperature)
- **Very low sticking coefficient** (Better chips evacuation)
- **Thickness:** approx. 1 micron
- **Colour:** bright black



KleinDIA is the most advantageous coating, ensuring:

- **Production increase**
- **Better finishing**
- **Less maintenance**

The surface coating **KleinDIA** can be applied on many other products giving extraordinary results depending on the type of material processed. Excellent results can be achieved processing solid wood, plywood, Plexiglas, plastic and graphitic materials.

HERE ARE SOME OF THE ITEMS WHICH ARE SUITABLE TO BE COATED WITH KleinDIA:

Solid carbide straight router bits
ART. A101/2/3 - C101/2/3 - C190 - D101/2



Page 1.07, 1.23, 2.05

Solid carbide spiral router bits
ART. T141/2/3 - T151/2/3 - T157/8/9



Page from 7.36 to 7.46

Solid carbide dowel drills
ART. L116 - L117



Pag. 5.11

Solid carbide through-hole boring bits
ART. L134 - L135



Pag. 5.12

HW reversible knives
ART. ZB



Pag. 11.10

HS planer knives
ART. ZC 30 - ZC 35



Pag. 11.11, 11.12, 11.13



SOLID CARBIDE SPIRAL ROUTER BITS FINISH/ROUGHING STYLE

ART. T344



KleinDIA coating for excellent performance

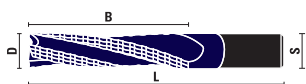

- Right-hand rotation with "UP CUT SPIRAL"
- To be used on machining centres, CNC routers and point to point machines
- For **softwood and hardwood, chipboard, MDF, HF, plywood, plastic coated, mineral materials (CORIAN® ecc.)**

RH rotation	D	B	L	Z
T344.080.RKD NEW	8	30	80	2
T344.100.RKD NEW	10	35	80	2
T344.120.RKD NEW	12	35	80	3
T344.121.RKD NEW	12	45	90	3
T344.140.RKD NEW	14	55	110	3
T344.160.RKD NEW	16	55	110	3
T344.161.RKD NEW	16	75	130	3
T344.200.RKD NEW	20	55	110	3
T344.201.RKD NEW	20	75	130	3

Router bits with diameter from 12 mm, are produced with shank for Seeger retaining rings



HOW TO DETERMINE THE FEEDING SPEED RELATING TO THE DIAMETER:

- Referring to item T344RKD with right hand rotation (UP CUT STYLE), Z=2/3
- Referring to item T354RKD with right hand rotation (DOWN CUT STYLE), Z=2/3
- Referring to item T354LKD with left hand rotation (UP CUT STYLE), Z=2/3
- RPM 18.000

Soft wood

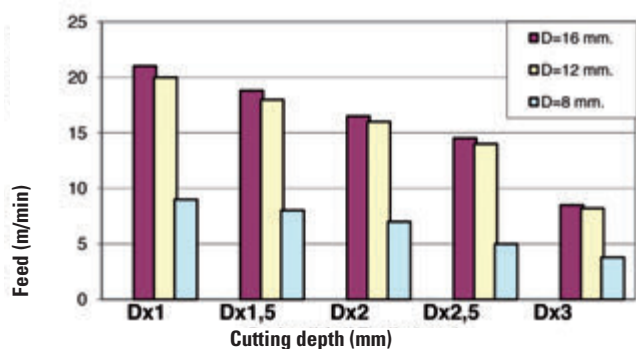

Hard wood

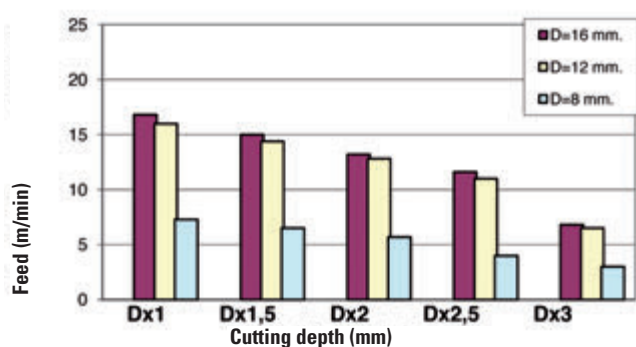

SOLID CARBIDE SPIRAL ROUTER BITS FINISH/ROUGHING STYLE

ART. T354



KleinDIA coating for excellent performance

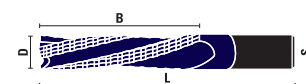

Good finish on panel top side



- Right-hand rotation with "DOWN CUT SPIRAL"
- To be used on machining centres, CNC routers and point to point machines
- For **softwood and hardwood, chipboard, MDF, HF, plywood, plastic coated, mineral materials (CORIAN® ecc.)**

RH rotation	D	B	L	Z
T354.100.RKD NEW	10	35	80	2
T354.120.RKD NEW	12	35	80	3
T354.160.RKD NEW	16	55	110	3
T354.161.RKD NEW	16	75	130	3
T354.200.RKD NEW	20	55	110	3

Router bits with diameter from 12 mm, are produced with shank for Seeger retaining rings



SOLID CARBIDE SPIRAL ROUTER BITS FINISH/ROUGHING STYLE

ART. T354



KleinDIA coating for excellent performance

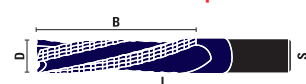

Good finish on bottom side



- Left-hand rotation with "UP CUT SPIRAL"
- To be used on machining centres, CNC routers and point to point machines
- For **softwood and hardwood, chipboard, MDF, HF, plywood, plastic coated, mineral materials (CORIAN® ecc.)**

LH rotation	D	B	L	Z
T354.100.LKD NEW	10	35	80	2
T354.120.LKD NEW	12	35	80	3
T354.160.LKD NEW	16	55	110	3
T354.161.LKD NEW	16	75	130	3
T354.200.LKD NEW	20	55	110	3

Router bits with diameter from 12 mm, are produced with shank for Seeger retaining rings



MODULAR DRAWER UNIT

Drawer unit

"Elegant, sturdy **Klein** drawer unit with an innovative, modern design and great modularity, where you can keep all your **Klein** tools in a clean, secure, well-organized place. Say good-bye to messiness and damaged tools. Now, with the new **Klein** drawer unit, you can put your storeroom in order in a convenient, functional way.

SMALL OUTSIDE BUT LARGE INSIDE
the **Klein** drawer unit takes up little space but can contain countless articles in its 10 drawers and 80 containers (8 containers per drawer).

- **STURDY**
since each drawer can hold around 8 kg.
- **LIGHT**
since it's made of a high-strength polypropylene co-polymer.
- **SECURE**
since each drawer has its own key.
- **PRACTICAL**
since it can be equipped with 4 casters for convenient movement or with slip-resistant feet.
- **CONVENIENT**
since it features a wooden top which acts as a practical surface for taking notes or keeping tools.
- **VERSATILE**
since the tubs in the drawers can be removed easily as desired.

Whether it's placed next to a CNC router, or close to a point-to-point boring machine, along the panel production line or in any carpentry shop, the new **Klein** drawer unit can be a real help in keeping the tools you use every day in perfect order and in good condition.



The new **Klein** drawer unit can hold a wide range of tools.
Ask our customer service how to receive it.

Modular drawer unit "CNC"

Ideal to store collet chucks, spring collets and spiral router bits beside your CNC machine



1st Drawer
Spring collets ER32

- Art. T119.060.N
- T119.080.N
- T119.100.N
- T119.120.N
- T119.140.N
- T119.160.N
- T119.180.N
- T119.200.N

2nd Drawer
Spring collets ER40

- Art. T123.080.N
- T123.100.N
- T123.120.N
- T123.140.N
- T123.160.N
- T123.180.N
- T123.200.N
- T123.250.N

3rd Drawer
Collet chucks and spring collets ER25

- Art. T118.700.R
- T118.800.R
- T118.976.R
- T118.980.R
- T125.060.N
- T125.080.N
- T125.100.N
- T125.120.N

4th Drawer
Spiral router bits Z=2

- Art. T142.040.R
- T142.050.R
- T142.061.R
- T142.080.R
- T142.081.R
- T142.100.R
- T142.101.R
- T142.121.R

5th Drawer
Spiral router bits Z=3

- Art. T143.081.R
- T143.100.R
- T143.101.R
- T143.121.R
- T143.161.R
- T143.180.R
- T143.200.R
- T143.201.R

6th Drawer
Spiral router bits Z=3 + chipbreaker

- Art. T144.081.R
- T144.100.R
- T144.101.R
- T144.121.R
- T144.161.R
- T144.180.R
- T144.200.R
- T144.201.R

7th Drawer
Spiral router bits Z=1

- Art. T141.030.R
- T141.040.R
- T141.050.R
- T141.061.R
- T141.081.R
- T141.100.R
- T151.061.R
- T151.081.R

8th Drawer
Spiral router bits Z=2 down-cut

- Art. T152.030.R
- T152.040.R
- T152.050.R
- T152.061.R
- T152.080.R
- T152.081.R
- T152.101.R
- T152.121.R

9th Drawer
Spiral router bits for locks

- Art. T153.100.R
- T153.120.R
- T153.160.R
- T154.081.R
- T154.120.R
- T154.160.R
- T157.140.R
- T157.162.R

10th Drawer
Straight cut router bits

- Art. D101.080.R
- D101.100.R
- D102.100.R
- D103.121.R
- D103.141.R
- D103.161.R
- D103.181.R
- D103.201.R

Router bits for aluminium and plastic working



8



**SOLID CARBIDE SPIRAL BITS
DOWN CUT Z=1**
Page 8.04



**SOLID CARBIDE SPIRAL BITS
UP CUT Z=1**
Page 8.04



**SOLID CARBIDE SPIRAL BITS
UP CUT Z=1 - Z=2**
Page 8.04



**SOLID CARBIDE SPIRAL BITS
DOWN CUT Z=2**
Page 8.04



**SOLID CARBIDE SPIRAL BITS
DOWN CUT Z=1**
Page 8.06



**SOLID CARBIDE SPIRAL BITS
UP CUT Z=1**
Page 8.06



**SOLID CARBIDE SPIRAL BITS
UP CUT Z=1 - Z=2**
Page 8.06



**SOLID CARBIDE SPIRAL BITS
DOWN CUT Z=2**
Page 8.06



**SOLID CARBIDE BITS FOR
GLASS FIBER WORKING**
Page 8.07

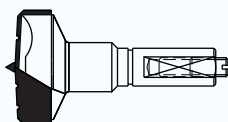

**HW HINGE BORING BITS FOR
ALUMINIUM Z=2**
Page 8.07



**SOLID CARBIDE SPIRAL BITS
DOWN CUT Z=2**
Page 8.07



**SOLID CARBIDE SPIRAL BITS
DOWN CUT Z=4**
Page 8.07



**SOLID CARBIDE DOUBLE DIAMETER
SPIRAL BITS Z=1**
Page 8.07



**HS UPCUT SPIRAL BITS FOR
ALUMINIUM Z=1**
Page 8.08



**HS UPCUT SPIRAL BITS FOR
ALUMINIUM Z=1**
Page 8.08



SET FOR ALU
Page 8.08



**HS DOUBLE DIAMETER SPIRAL BITS
FOR ALUMINIUM Z=2**
Page 8.09



HS SPECIAL BITS FOR PVC Z=1
Page 8.09



HS SPECIAL BITS FOR PVC Z=2
Page 8.09



**HS UPCUT SPIRAL CUTTERS FOR
ALUMINIUM Z=2-Z=3**
Page 8.09



**HS DRILLING BITS FOR PVC AND
ALUMINIUM WORKING Z=2**
Page 8.09

Klein®



CLASSIFICATION OF PLASTIC MATERIALS

“Plastic” is a generic term used to indicate a type of material that can actually be constituted by an innumerable variety of combinations of polymer structures and sizes.

For this reason it is very hard to define precisely the working parameters (feed rates and RPM) of plastic materials.

Here some guidelines that can help:

working with a CNC machine;

- use router bits Z=1 which allow a better chip flow, when working soft or flexible material;
- increase the chip load to avoid tool wear;

working with a table saw;

- use a sawblade with higher number of teeth when working hard materials.

Plastic working with a CNC machine, RPM =18.000, solid carbide router bit Z=1

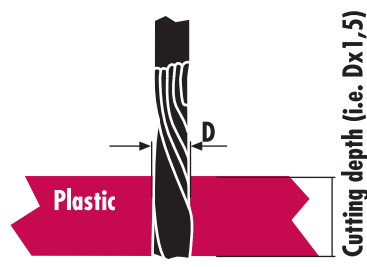
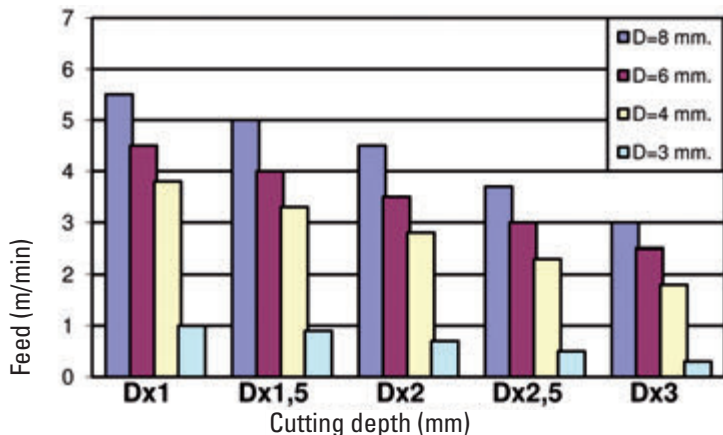

The harder is the material, the higher is the tensile strength (MPa). Harder material is less elastic (%). In this case it is recommended to use tools with higher number of teeth.

Reference table to identify the type of plastic processed and the right tool to use

Symbol	Abbreviation	Name	Tensile strength (MPa)	Elongation at ruptore (%)	Some examples of use
01 PET	PETE PET	Polyethylene Terephthalate or arnite	2300-10300	7	Plastic bottles, belts, pipes, etc.
01 PET	POLYESTER	Polyethylene Terephthalate or arnite	2400	300	Home design (flooring and furniture coating), clothing, etc.
02 PE-HD	HDPE	High density Polyethylene	700-1400	15-100	Bottles, packaging, wood plastic composites, etc.
03 PVC	PVC V	Polyvinyl chloride	200-4200	2-30	Pipes, fencing, containers, etc.
04 PE-LD	LDPE	Low density Polyethylene	100-250	50-800	General purpose containers, aseptic packaging, etc.
05 PP	PP	Polyethylene or Moplen	1350	150-600	Automotive industry and fibre production
06 PS	PS	Polystyrene	2400-3350	1-4	Toys, office supplies, trays, videotapes, thermal insulation foam (Styrofoam™), etc.
07 O	METHYL METHACRYLATE RESIN	Synthetic polyamides	1500-3000	30-150	Furniture, flooring, clothing, etc.
07 O	FIBERGLASS	Synthetic polyamides	4500	40	Shipbuilding, aerospace and automotive industry, etc.

SOLID CARBIDE SPIRAL BITS DOWN CUT Z=1

ART. U101



- Right-hand rotation with "DOWN CUT SPIRAL"
- Polished cutting edge for improved chip evacuation
- Use on CNC and high speed machines
- For working plastic materials (thin prefinished panels, 3/4 mm.), PVC, HDPE, PET, acrylic materials and solid surface

RH rotation	D	B	L	S
U101.030.R NEW	3	15	50	3
U101.040.R	4	35	70	4
U101.041.R NEW	4	20	60	4
U101.050.R	5	35	70	5
U101.051.R NEW	5	25	60	5
U101.060.R	6	35	80	6
U101.061.R NEW	6	25	70	6
U101.080.R	8	35	80	8
U101.081.R NEW	8	25	70	8
U101.100.R	10	35	80	10
U101.101.R NEW	10	25	70	10
U101.120.R	12	35	80	12

SOLID CARBIDE SPIRAL BITS UP CUT Z=1

ART. U102



- Right-hand rotation with "UP CUT SPIRAL"
- Polished cutting edge for improved chip evacuation
- Use on CNC and high speed machines
- For working plastic materials, fiberglass, phenols materials and solid surface

RH rotation	D	B	L	S
U102.040.R NEW	4	35	70	4
U102.050.R NEW	5	35	70	5
U102.060.R NEW	6	35	80	6
U102.080.R NEW	8	35	80	8
U102.100.R NEW	10	35	80	10

SOLID CARBIDE SPIRAL BITS UP CUT Z=1 - Z=2

ART. U111 - U112

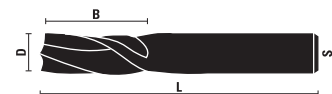

- Right-hand rotation with "UP CUT SPIRAL"
- Polished cutting edge for improved chip evacuation
- For working aluminium, fiberglass and phenols materials

RH rotation	D	B	L	S	Z
U111.030.R	3	12	60	6	1
U111.040.R	4	12	60	6	1
U111.050.R	5	16	60	6	1
U111.060.R	6	16	60	6	1
U111.061.R NEW	6	35	80	6	1
U111.080.R	8	18	60	8	1
U111.081.R NEW	8	35	80	8	1
U111.100.R	10	22	70	10	1
U111.120.R	12	24	70	12	1
U112.040.R	4	10	60	6	2
U112.050.R	5	12	60	6	2
U112.060.R	6	15	60	6	2
U112.080.R	8	20	60	8	2
U112.100.R	10	22	70	10	2
U112.120.R	12	25	80	12	2
U112.140.R	14	25	80	14	2
U112.160.R	16	25	80	16	2

Router bits with diameter from 12 mm to 16 mm, are produced with shank fit for Seeger retaining rings



SOLID CARBIDE SPIRAL BITS DOWN CUT Z=2

ART. U120

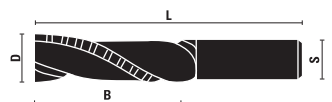

- Right-hand rotation with "UP CUT SPIRAL"
- For working wood and aluminium material

RH rotation	D	B	L	S
U120.140.R	14	42	100	14
U120.160.R	16	42	100	16
U120.180.R	18	62	120	18
U120.200.R	20	62	120	20

Router bits with diameter from 14 mm to 20 mm, are produced with shank fit for Seeger retaining rings



KleinDIA

A surface treatment developed for large-scale production

KleinDIA is a DLC (**Diamond-like Carbon**) anti-friction coating which allows to solve problems of tool abrasion, chip evacuation and chemical attack.

A layer of approx. 1 micron is laid on the tool surface at low temperature, thus not altering the properties of the router bit or knife. Its high hardness is granted by both Sp2 (**Graphite**) and Sp3 (**Diamond**) carbon hybridisation.

Our several tests confirmed remarkable results on both panel working and solid wood processing.

Working plastic and aluminium without coolant is also possible thanks to a very low friction coefficient.

TECHNICAL FEATURES:

- **High hardness** Hv0,025: 2500-3100
- **Higher wear resistance** (longer working time)
- **Low frictional coefficient** (lowered working temperature)
- **Very low sticking coefficient** (Better chips evacuation)
- **Thickness:** approx. 1 micron
- **Colour:** bright black



KleinDIA is the most advantageous coating, ensuring:

- **Production increase**
- **Better finishing**
- **Less maintenance**

The surface coating **KleinDIA** can be applied on many other products giving extraordinary results depending on the type of material processed. Excellent results can be achieved processing solid wood, plywood, Plexiglas, plastic and graphitic materials.

HERE ARE SOME OF THE ITEMS WHICH ARE SUITABLE TO BE COATED WITH **KleinDIA**:

Solid carbide straight router bits
ART. A101/2/3 - C101/2/3 - C190 - D101/2



Page 1.07, 1.23, 2.05

Solid carbide spiral router bits
ART. T141/2/3 - T151/2/3 - T157/8/9



Page from 7.36 to 7.46

Solid carbide dowel drills
ART. L116 - L117



Pag. 5.11

Solid carbide through-hole boring bits
ART. L134 - L135



Pag. 5.12

HW reversible knives
ART. ZB



Pag. 11.10

HS planer knives
ART. ZC 30 - ZC 35



Pag. 11.11, 11.12, 11.13



SOLID CARBIDE SPIRAL BITS DOWN CUT Z=1

ART. U101

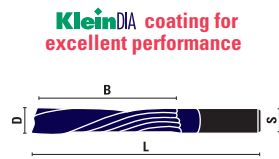

- Right-hand rotation with "DOWN CUT SPIRAL"
- Polished cutting edge for improved chip evacuation
- Use on CNC and high speed machines
- For working plastic materials (thin prefinished panels, 3/4 mm.), PVC, HDPE, PET, acrylic materials and solid surface

RH rotation	D	B	L	S
U101.030.RKD NEW	3	15	50	3
U101.040.RKD NEW	4	35	70	4
U101.041.RKD NEW	4	20	60	4
U101.050.RKD NEW	5	35	70	5
U101.051.RKD NEW	5	25	60	5
U101.060.RKD NEW	6	35	80	6
U101.061.RKD NEW	6	25	70	6
U101.080.RKD NEW	8	35	80	8
U101.081.RKD NEW	8	25	70	8
U101.100.RKD NEW	10	35	80	10
U101.101.RKD NEW	10	25	70	10
U101.120.RKD NEW	12	35	80	12

SOLID CARBIDE SPIRAL BITS UP CUT Z=1

ART. U102

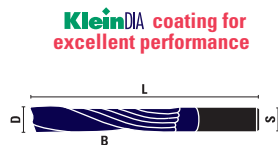

- Right-hand rotation with "UP CUT SPIRAL"
- Polished cutting edge for improved chip evacuation
- Use on CNC and high speed machines
- For working plastic materials, fiberglass, phenols materials and solid surface

RH rotation	D	B	L	S
U102.040.RKD NEW	4	35	70	4
U102.050.RKD NEW	5	35	70	5
U102.060.RKD NEW	6	35	80	6
U102.080.RKD NEW	8	35	80	8
U102.100.RKD NEW	10	35	80	10

SOLID CARBIDE SPIRAL BITS UP CUT Z=1-Z=2

ART. U111 - U112

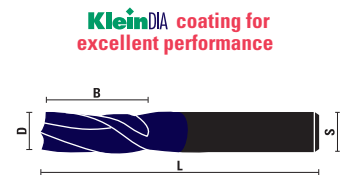

- Right-hand rotation with "UP CUT SPIRAL"
- Polished cutting edge for improved chip evacuation
- For working aluminium, fiberglass and phenols materials

RH rotation	D	B	L	S	Z
U111.030.RKD NEW	3	12	60	6	1
U111.040.RKD NEW	4	12	60	6	1
U111.050.RKD NEW	5	16	60	6	1
U111.060.RKD NEW	6	16	60	6	1
U111.061.RKD NEW	6	35	80	6	1
U111.080.RKD NEW	8	18	60	8	1
U111.081.RKD NEW	8	35	80	8	1
U111.100.RKD NEW	10	22	70	10	1
U111.120.RKD NEW	12	24	70	12	1
U112.040.RKD NEW	4	10	60	6	2
U112.050.RKD NEW	5	12	60	6	2
U112.060.RKD NEW	6	15	60	6	2
U112.080.RKD NEW	8	20	60	8	2
U112.100.RKD NEW	10	22	70	10	2
U112.120.RKD NEW	12	25	80	12	2
U112.140.RKD NEW	14	25	80	14	2
U112.160.RKD NEW	16	25	80	16	2

Router bits with diameter from 12 mm to 16 mm, are produced with shank fit for Seeger retaining rings



SOLID CARBIDE SPIRAL BITS DOWN CUT Z=2

ART. U120

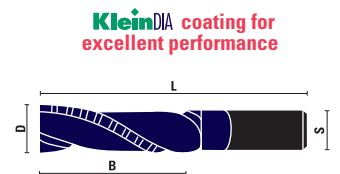

- Right-hand rotation with "UP CUT SPIRAL"
- For working wood and aluminium material

RH rotation	D	B	L	S
U120.140.RKD NEW	14	42	100	14
U120.160.RKD NEW	16	42	100	16
U120.180.RKD NEW	18	62	120	18
U120.200.RKD NEW	20	62	120	20

Router bits with diameter from 14 mm to 20 mm, are produced with shank fit for Seeger retaining rings



SOLID CARBIDE BITS FOR GLASS FIBER WORKING

ART. U130

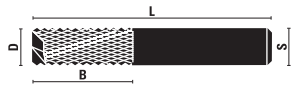

- Right-hand rotation
- For routing and shearing
- Use on portable machines, CNC and routing machines
- For working plastic materials, rubber and fiberglass

RH rotation	D	B	L	S
U130.030.R NEW	3	12	38	3
U130.040.R NEW	4	15	40	4
U130.050.R NEW	5	18	50	5
U130.060.R NEW	6	22	55	6
U130.080.R NEW	8	30	70	8
U130.100.R NEW	10	30	72	10
U130.120.R NEW	12	30	73	12

HW HINGE BORING BITS FOR ALUMINIUM Z=2

ART. U140

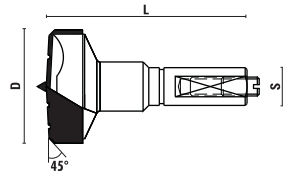

- Chip-breaker execution Z=2
- For working aluminium

RH rotation	D	L	S	Rot.
U140.250.R NEW	25	57,5	10x26	Dx
U140.350.R NEW	35	57,5	10x26	Dx



Z051.302.R

SOLID CARBIDE SPIRAL BITS DOWN CUT Z=2

ART. U150

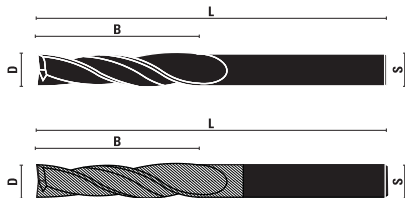

- "RT" with special coating **TICN** for working inox and ferrous materials
- Use on CNC machines
- For working **aluminum** and **ferrous materials**

RH rotation	D	B	L	S
U150.060.R NEW	6	16	60	6
U150.080.R NEW	8	45	100	8
U150.100.R NEW	10	22	70	10
U150.060.RT NEW	6	16	60	6
U150.080.RT NEW	8	45	100	8
U150.100.RT NEW	10	22	70	10

SOLID CARBIDE SPIRAL BITS DOWN CUT Z=4

ART. U155 - U156

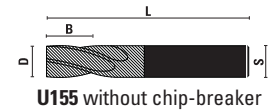

U155 without chip-breaker

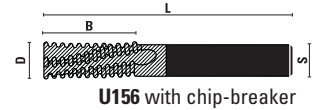

U156 with chip-breaker

- "RT" with special coating "**TINALOX**"
- Use on CNC machines
- For working **inox** and **ferrous materials**

RH rotation	D	B	L	S	Z
U155.060.RT NEW	6	15	60	6	4
U155.080.RT NEW	8	19	65	8	4
U156.060.RT NEW	6	21	60	6	4 chip-breaker
U156.080.RT NEW	8	25	70	8	4 chip-breaker

SOLID CARBIDE DOUBLE DIAMETER SPIRAL BITS Z=1

ART. U190

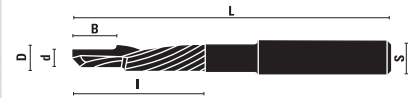

- Right-hand rotation with "**UP CUT SPIRAL**"
- Use on CNC machines
- For working **aluminum** and **ferrous materials**

RH rotation	d	D	B	I	L	S
U190.030.R NEW	3	8	5	30	80	8
U190.055.R NEW	5,5	8	10	25	100	8
U190.060.R NEW	6	11,5	10	40	100	12

HS UPCUT SPIRAL BITS FOR ALUMINIUM Z=1

ART. U201 - U211 - U221

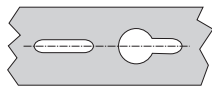
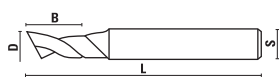

- Manufactured in HS 5% cobalt
- Used for alu profiles
- Plunging and routing
- Use with lubricant

RH rotation	D	B	L	S	Z
U201.030.R	3	12	60	8	1
U201.040.R	4	12	60	8	1
U201.041.R	4	40	100	8	1
U201.042.R	4	12	100	8	1
U201.050.R	5	14	70	8	1
U201.051.R	5	40	100	8	1
U201.052.R	5	14	100	8	1
U201.053.R	5	14	120	8	1
U201.054.R	5	25	70	8	1
U201.055.R	5	25	100	8	1
U201.056.R	5	40	120	8	1
U201.060.R	6	14	70	8	1
U201.061.R	6	40	100	8	1
U201.062.R	6	14	100	8	1
U201.063.R	6	25	70	8	1
U201.070.R	7	14	70	8	1
U201.080.R	8	14	80	8	1
U201.081.R	8	30	100	8	1
U201.082.R	8	14	100	8	1
U201.083.R	8	14	120	8	1
U201.084.R	8	25	80	8	1
U201.085.R	8	25	120	8	1
U201.090.R	9	14	80	8	1
U201.100.R	10	14	80	8	1
U201.101.R	10	14	100	8	1
U201.102.R	10	14	120	8	1
U201.120.R	12	14	80	8	1
U211.030.R	3	12	60	6	1
U211.040.R	4	12	60	6	1
U211.050.R	5	14	60	6	1
U211.060.R	6	14	60	6	1
U211.061.R	6	27	70	6	1
U221.030.R	3	12	60	10	1
U221.040.R	4	12	60	10	1
U221.050.R	5	14	60	10	1
U221.060.R	6	14	60	10	1
U221.080.R	8	14	80	10	1
U221.100.R	10	14	80	10	1
U221.101.R	10	14	120	10	1
U221.120.R	12	14	80	10	1

HS UPCUT SPIRAL BITS FOR ALUMINIUM Z=1

ART. U202

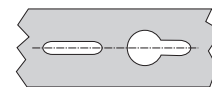
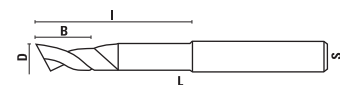

- Manufactured in HS 5% cobalt
- Used for alu profiles
- Plunging and routing
- Use with lubricant
- Reduced throat execution

RH rotation	D	B/I	L	S	Z
U202.040.R	4	16/55	90	8	1
U202.050.R	5	14/35	80	8	1
U202.051.R	5	14/35	120	8	1
U202.052.R	5	16/55	90	8	1
U202.053.R	5	18/35	100	8	1
U202.054.R	5	20/45	100	8	1
U202.055.R NEW	5	20/55	80	10	1
U202.056.R NEW	5	20/55	100	10	1
U202.060.R	6	14/55	85	8	1
U202.061.R	6	14/35	80	8	1
U202.062.R	6	14/45	90	8	1
U202.063.R NEW	6	20/55	100	10	1
U202.080.R	8	14/60	80	8	1
U202.081.R	8	14/90	120	8	1
U202.082.R	8	14/70	100	8	1
U202.083.R	8	30/70	100	8	1
U202.100.R	10	14/60	80	10	1
U202.101.R	10	14/70	100	10	1
U202.102.R	10	14/95	120	10	1
U202.103.R	10	30/70	100	10	1

SET FOR ALU

ART. X015



Wooden box

Item
X015.009.R
9-pcs set for alu:
U201.030.R
U201.040.R
U201.050.R
U201.060.R
U201.080.R
U201.100.R
U202.050.R
U202.060.R
U202.080.R

HS DOUBLE DIAMETER SPIRAL BITS FOR ALUMINIUM Z=2

ART. U230

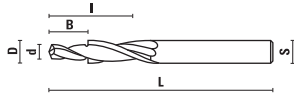

RH rotation	d/D	B/l	L	S
U230.030.R	3/6	8/15	60	6

HS SPECIAL BITS FOR PVC Z=1

ART. U240

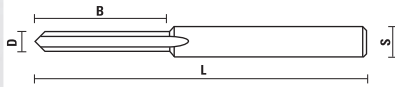

- Plunging
- For working PVC profiles on Elumec, Rotox, Striffler machines

RH rotation	D	B	L	S
U240.050.R	5	35	102	8
U240.051.R	5	45	102	8
U240.052.R	5	55	102	8
U240.060.R	6	30	102	8

HS SPECIAL BITS FOR PVC Z=2

ART. U241

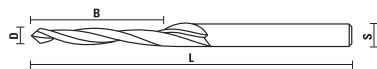

- Through hole execution
- For working PVC profiles on Elumec, Rotox, Striffler machines

RH rotation	D	B	L	S
U241.050.R	5	40	100	8

HS UPCUT SPIRAL CUTTERS FOR ALUMINIUM Z=2-Z=3

ART. U250

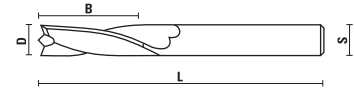

- Manufactured in HS 5% cobalt
- Use on CNC and milling machines
- For working **aluminum** and **ferrous materials**

RH rotation	D	B	L	S	Z
U250.040.R	4	12	63	6	2
U250.050.R	5	25	68	6	2
U250.060.R	6	25	68	6	2
U250.080.R	8	25	88	8	2
U250.100.R	10	35	95	10	2
U250.120.R	12	35	110	12	2
U250.140.R	14	37	110	14	3
U250.160.R	16	40	123	16	3
U250.180.R	18	40	123	18	3
U250.200.R	20	45	130	20	3

HS DRILLING BITS FOR PVC AND ALUMINIUM WORKING Z=2

ART. U260

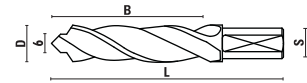

- To be used on our **Trimatic 43/0** boring jigs for mounting cremona bolt on **PVC** and/or **aluminium** doors and windows

RH rotation	LH rotation	D	B	L	S
	U260.080.L	8	50	76	10x20
	U260.100.L	10	50	76	10x20
U260.120.R	U260.120.L	12	50	76	10x20
U260.140.R		14	50	76	10x20

Some examples of drilling patterns

SIEGENIA-TRIAL **WEIDTMANN-KURLER**

U260.120.L	2	U260.100.L	2
U260.120.R	1	U260.140.R	1

G-U JET77	OLIVEN
U260.100.L	2
U260.120.R	1
U260.080.L	2
U260.120.R	1

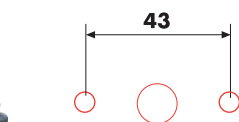
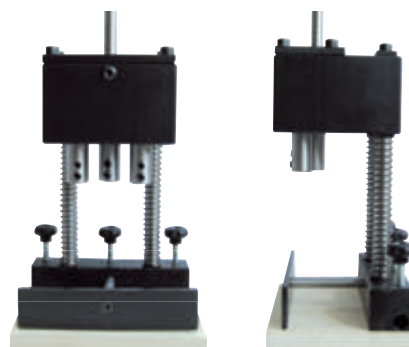
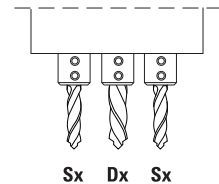

Trimatic 43/0

HS DRILLING BITS FOR PVC AND ALUMINIUM WORKING Z=2

ART. U270

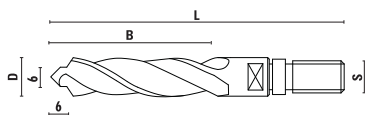

To produce holes for inserting handles on **PVC** and **aluminium** workpieces

RH rotation	LH rotation	D	B	L	S
	U270.080.L NEW	8	50	93	M10
	U270.100.L NEW	10	50	93	M10
	U270.120.L NEW	12	49	93	M10
U270.120.R NEW		12	55	98	M10
U270.140.R NEW		14	55	98	M10

HW DRILLS FOR WORKING ALUCOBOND® Z=2

ART. U180

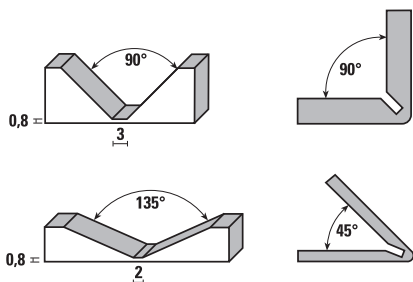
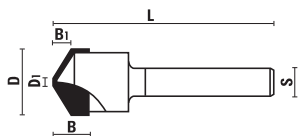

Grooves for folding **ALUCOBOND®**

S Ø 8	D	D1	α	B	B1	L
U180.090.R NEW	18	3	90°	10	8	60
U180.135.R NEW	18	2	135°	10	3,3	60

HS DRILLING BITS FOR ALUCOBOND® Z=2

ART. U280 - U281

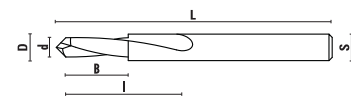

For boring holes for rivets **ALUCOBOND®**

RH rotation	d/D	B/l	L	S
U280.070.R NEW	5,1/7	16,5/14	73	9,5
U280.085.R NEW	5,1/8,5	16,5/14	73	9,5

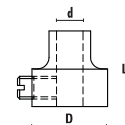

Reference setting jings

RH rotation	d/D	L
U281.070.R NEW	7/20	20
U281.085.R NEW	8,5/20	20

HS DOUBLE DIAMETER SPIRAL BITS FOR ALUMINIUM Z=2

ART. U290 - U291

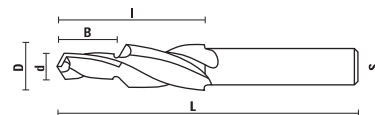

RH rotation	d/D	B/l	L	S
U290.055.R	5,5/11,5	12/35	100	10
U290.060.R	6/11,5	12/35	100	10
U290.061.R	6/12	15/35	80	10
U290.062.R	6/14	15/35	80	10
U290.065.R	6,5/13,5	15/35	100	10
U290.070.R	7/13	12/35	100	10
U290.071.R	7/14	12/35	100	10
U290.072.R	7/15	12/35	100	10
U290.080.R	8/15	12/35	100	10

U291.055.R	5,5/11,5	12/35	120	12
U291.060.R	6/12	12/35	100	12
U291.065.R	6,5/11,5	12/35	100	12
U291.066.R	6,5/12	18/45	120	12
U291.067.R	6,5/13,5	12/35	120	12
U291.085.R	8,5/14	12/35	100	12

HOLDING SLEEVES FOR MILLING CUTTER SETS WITH MANUAL INSERTION

ART. YC 320

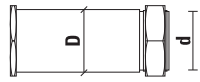

Item	D	d	Type
YC320.160	32	M16	Manual
YC320.220	32	M22	Manual
YC320.270	32	M27	Manual

QUICK CHANGE HOLDING SLEEVES FOR MILLING CUTTER SETS

ART. YC 320

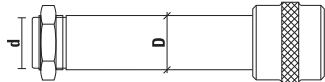

Item	D	d	Type
YC320.900	32	M30	quick change

SPACERS

ART. YD 320

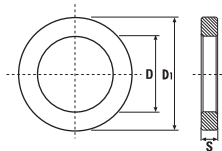

- Use with holding sleeves for aluminium working
- Burnished

Item	D	D1	S
YD320.003	32	45	0,3
YD320.005	32	45	0,5
YD320.010	32	45	1
YD320.020	32	45	2
YD320.050	32	42	5
YD320.100	32	42	10
YD320.150	32	42	15
YD320.200	32	42	20
YD320.300	32	42	30
YD320.400	32	42	40
YD320.500	32	42	50
YD320.600	32	42	60
YD320.800	32	42	80
YD320.900	32	42	90

HW ALTERNATE TOOTH MILLING CUTTERS

ART. YF 060÷YF120

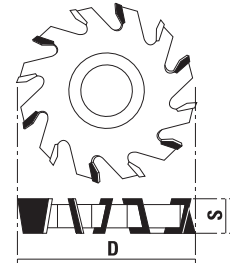

Alternate teeth for better quality of cut

Item	D	S	F	Z
YF060.040	60	4	32	6
YF060.050	60	5	32	6
YF060.060	60	6	32	6
YF060.070	60	7	32	6
YF060.080	60	8	32	6
YF060.100	60	10	32	6
YF060.120	60	12	32	6
YF060.140	60	14	32	6
YF060.160	60	16	32	6
YF070.040	70	4	32	8
YF070.050	70	5	32	8
YF070.060	70	6	32	8
YF070.070	70	7	32	8
YF070.080	70	8	32	8
YF070.100	70	10	32	8
YF070.120	70	12	32	8
YF070.140	70	14	32	8
YF070.160	70	16	32	8
YF080.040	80	4	32	8
YF080.050	80	5	32	8
YF080.060	80	6	32	8
YF080.070	80	7	32	8
YF080.080	80	8	32	8
YF080.100	80	10	32	8
YF080.120	80	12	32	8
YF080.140	80	14	32	8
YF080.160	80	16	32	8
YF080.180	80	18	32	8
YF080.200	80	20	32	8
YF090.040	90	4	32	8
YF090.050	90	5	32	8
YF090.060	90	6	32	8
YF090.070	90	7	32	8
YF090.080	90	8	32	8
YF090.100	90	10	32	8
YF090.120	90	12	32	8
YF090.140	90	14	32	8
YF090.160	90	16	32	8
YF090.180	90	18	32	8
YF090.200	90	20	32	8
YF100.040	100	4	32	10
YF100.050	100	5	32	10
YF100.060	100	6	32	10
YF100.070	100	7	32	10
YF100.080	100	8	32	10
YF100.100	100	10	32	10
YF100.120	100	12	32	10
YF100.140	100	14	32	10
YF100.160	100	16	32	10
YF100.180	100	18	32	10
YF100.200	100	20	32	10
YF100.250	100	25	32	10
YF100.300	100	30	32	10
YF114.040	114	4	32	12
YF114.050	114	5	32	12
YF114.060	114	6	32	12
YF114.070	114	7	32	12
YF114.080	114	8	32	12
YF114.100	114	10	32	12
YF114.120	114	12	32	12
YF114.140	114	14	32	12
YF114.160	114	16	32	12
YF114.180	114	18	32	12
YF114.200	114	20	32	12
YF114.250	114	25	32	12
YF114.300	114	30	32	12
YF120.040	120	4	32	14
YF120.050	120	5	32	14
YF120.060	120	6	32	14
YF120.070	120	7	32	14
YF120.080	120	8	32	14
YF120.100	120	10	32	14
YF120.120	120	12	32	14
YF120.140	120	14	32	14
YF120.160	120	16	32	14
YF120.180	120	18	32	14
YF120.200	120	20	32	14
YF120.250	120	25	32	14
YF120.300	120	30	32	14

SPECIAL UNITS FOR ALUMINIUM-PROFILES

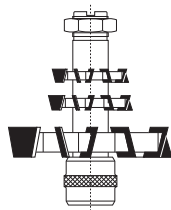

- PRODUCED ON REQUEST
- PLEASE SEND US YOUR INQUIRY WITH TECHNICAL INFORMATION RELATED

Item	Description
ART. YG 000	For alu-profiles "ALL. CO"
ART. YG 001	For alu-profiles "ALCAN"
ART. YG 002	For alu-profiles "EQUIPE"
ART. YG 003	For alu-profiles "ESA ALLUMINIO"
ART. YG 004	For alu-profiles "DOMAL SER. HYDRO ALLUMINIO"
ART. YG 005	For alu-profiles "INDIVEST / ALPHA"
ART. YG 006	For alu-profiles "JOINT (wood - alu)"
ART. YG 007	For alu-profiles "KIKAU"
ART. YG 008	For alu-profiles "METRA"
ART. YG 009	For alu-profiles "NEW"
ART. YG 010	For alu-profiles "OCMA"
ART. YG 011	For alu-profiles "GLOBAL"
ART. YG 012	For alu-profiles "PANDOLFO - SCHUKO"
ART. YG 013	For alu-profiles "PASSERINI"
ART. YG 014	For alu-profiles "RAI - ALLUMINIA"
ART. YG 015	For alu-profiles "TRAFILERIE EMILIANE"
ART. YG 016	For alu-profiles "ITAL - PLASTICK"

HW TRIMMING AND SIZING SAWBLADES

ART. FCS

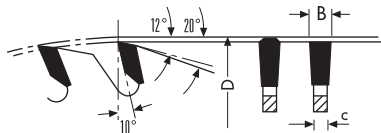

- FZ/TR triple chip teeth trapezoidal
- For table saws
- Ideal for working **ALUCOBOND®**
- For cutting **hardwoods, double sided veneer and laminate board, MDF, hard paper and thermoplastic boards**
- Extra finish and long cutting life
- ♪ = no-noise
- HW grade: KCR06 (K01-C4)

Pin holes: PH02= 2/7/42 + 2/9,5/46,5 + 2/10/60



Item	D	d	B/c	Z	Pin holes
FCS250.06030 ♪	250	30	3,2/2,2	60	PH02
FCS250.08030 ♪	250	30	3,2/2,2	80	PH02
FCS300.07230 ♪	300	30	3,2/2,2	72	PH02
FCS300.09630 ♪	300	30	3,2/2,2	96	PH02
FCS350.08430 ♪	350	30	3,5/2,5	84	PH02
FCS350.11230 ♪	350	30	3,5/2,5	108	PH02

HW TRIMMING AND SIZING SAWBLADES

ART. FB

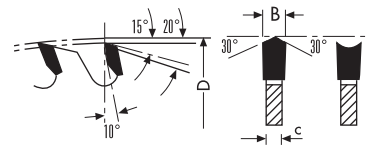

- HZ/DZ inverted "V" and hollow ground teeth
- For cutting boards with **synthetic resincoating, double sided veneer and laminate boards and plywood**
- For panel saws and table saws
- Extra finish and long cutting life
- HW grade: KCR06 (K01-C4)

Pin holes: PH02= 2/7/42 + 2/9,5/46,5 + 2/10/60

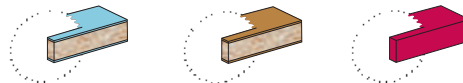

Item	D	d	B/c	Z	Pin holes
FB220.04230	220	30	3,2/2,2	42	
FB253.04830	250	30	3,2/2,2	48	PH02
FB303.06030	300	30	3,2/2,2	60	PH02
FB350.07230	350	30	3,5/2,5	72	PH02

HW SAWBLADES FOR PVC AND PLEXIGLASS

ART. MGS

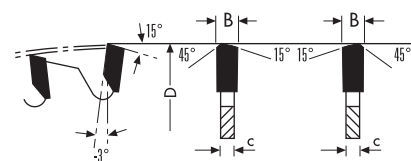

- WZ/FA alternate-trap, teeth
- 3° negative hook angle
- Suitable for **thin plastic, plexiglass, PVC and plywood**
- ♪ = **No-noise**
- HW grade: KCR06 (K01-C4)

Pin holes: PH02= 2/7/42 + 2/9,5/46,5 + 2/10/60

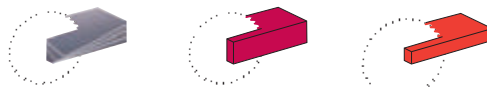

Item	D	d	B/c	Z	Pin holes
MGS250.08030 ♪	250	30	2,6/2,0	80	PH02
MGS300.08430 ♪	300	30	2,6/2,0	84	PH02
MGS300.09630 ♪	300	30	2,6/2,0	96	PH02

HW SAWBLADES FOR ALUMINIUM

ART. LB

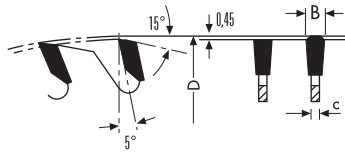

- FZ/TR triple chip teeth
- 5° positive hook angle
- For **Alu, PVC** and **non-ferrous metals**
- For table saws
- = **no-noise with a special sound absorbing material inside of silent slots**
- HW grade: **HC10 (K10-C3)**

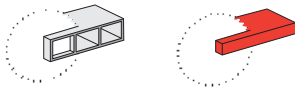

Item	D	d	B/c	Z	Pin holes
LA200.06430	200	30	3,2/2,6	64	2/11/63
LA200.06432	200	32	3,2/2,6	64	2/11/63
LA250.06030	250	30	3,4/2,6	60	2/11/63
LA250.06032	250	32	3,4/2,6	60	2/11/63
LA250.08030	250	30	3,4/2,6	80	2/11/63
LA250.08032	250	32	3,4/2,6	80	2/11/63
LA300.07230	300	30	3,4/2,6	72	2/11/63
LA300.07232	300	32	3,4/2,6	72	2/11/63
LA300.08430	300	30	3,4/2,6	84	2/11/63
LA300.08432	300	32	3,4/2,6	84	2/11/63
LA300.09630	300	30	3,4/2,6	96	2/11/63
LA300.09632	300	32	3,4/2,6	96	2/11/63
LA350.08430	350	30	3,4/2,6	84	2/11/63
LA350.08432	350	32	3,4/2,6	84	2/11/63
LA350.09630	350	30	3,4/2,6	96	2/11/63
LA350.09632	350	32	3,4/2,6	96	2/11/63
LA350.10830	350	30	3,4/2,6	108	2/11/63
LA350.10832	350	32	3,4/2,6	108	2/11/63
LA400.09630	400	30	4,0/3,2	96	2/11/63
LA400.09632	400	32	4,0/3,2	96	2/11/63
LA400.12030	400	30	4,0/3,2	120	2/11/63
LA400.12032	400	32	4,0/3,2	120	2/11/63
LA420.09632 NEW	420	32	4,0/3,2	96	2/11/63
LA450.09630	450	30	4,0/3,2	96	2/11/63
LA450.09632	450	32	4,0/3,2	96	2/11/63
LA450.10830	450	30	4,0/3,2	108	2/11/63
LA450.10832	450	32	4,0/3,2	108	2/11/63
LA500.12030	500	30	4,6/3,6	120	2/11/63
LA500.12032	500	32	4,6/3,6	120	2/11/63
LA500.12132 NEW	500	32	4,0/3,4	120	2/11/63
LA550.14030 NEW	550	30	4,6/3,6	140	2/11/63
LA600.14030 NEW	600	30	4,6/3,6	140	2/11/63

HW SAWBLADES FOR ALUMINIUM

ART. LB

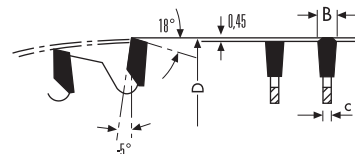

- FZ/TR triple chip teeth
- 5° positive hook angle
- For **Alu, PVC** and **non-ferrous metals**
- For table saws
- = **no-noise with a special sound absorbing material inside of silent slots**
- HW grade: **HC10 (K10-C3)**

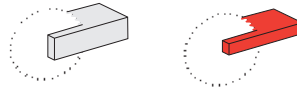

Item	D	d	B/c	Z	Pin holes
LB200.06430	200	30	3,2/2,6	64	2/11/63
LB200.06432	200	32	3,2/2,6	64	2/11/63
LB250.06030	250	30	3,4/2,6	60	2/11/63
LB250.08030	250	30	3,4/2,6	80	2/11/63
LB250.08032	250	32	3,4/2,6	80	2/11/63
LB300.07230	300	30	3,4/2,6	72	2/11/63
LB300.08430	300	30	3,4/2,6	84	2/11/63
LB300.08432	300	32	3,4/2,6	84	2/11/63
LB300.09630	300	30	3,4/2,6	96	2/11/63
LB300.09632	300	32	3,4/2,6	96	2/11/63
LB350.08430	350	30	3,4/2,6	84	2/11/63
LB350.08432	350	32	3,4/2,6	84	2/11/63
LB350.09630	350	30	3,4/2,6	96	2/11/63
LB350.09632	350	32	3,4/2,6	96	2/11/63
LB350.10830	350	30	3,4/2,6	108	2/11/63
LB350.10832	350	32	3,4/2,6	108	2/11/63
LB400.09630	400	30	4,0/3,2	96	2/11/63
LB400.09632	400	32	4,0/3,2	96	2/11/63
LB400.12030	400	30	4,0/3,2	120	2/11/63
LB400.12032	400	32	4,0/3,2	120	2/11/63
LB450.09630	450	30	4,0/3,2	96	2/11/63
LB450.09632	450	32	4,0/3,2	96	2/11/63
LB450.10830	450	30	4,0/3,2	108	2/11/63
LB450.10832	450	32	4,0/3,2	108	2/11/63
LB500.12030	500	30	4,6/3,6	120	2/11/63
LB500.12032	500	32	4,6/3,6	120	2/11/63
LB550.14030 NEW	550	30	4,6/3,6	140	2/11/63
LB600.14030 NEW	600	30	4,6/3,6	140	2/11/63

RPM suggested referred to the blade diameter

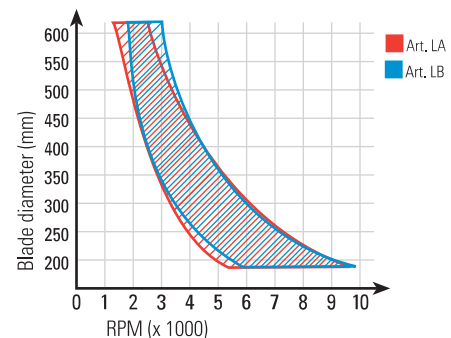

Insert router bits and DP router bits



9

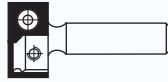

HW INSERT FLUSH TRIM BITS Z=2
Page 9.05

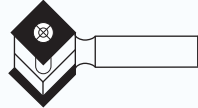

HW INSERT ANGLE BITS Z=2
Page 9.05

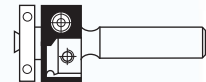

HW INSERT FLUSH TRIM BITS
WITH BALL BEARING GUIDE Z=2
Page 9.05

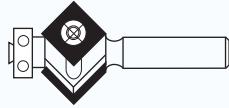

HW INSERT FLUSH TRIM BITS
WITH BALL BEARING GUIDE Z=2
Page 9.05

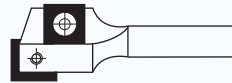

HW INSERT FLUSH BITS Z=2+1
Page 9.05

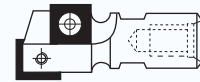

HW INSERT FLUSH BITS Z=2+1
Page 9.05



HW INSERT FLUSH TRIMMING BITS Z=2
Page 9.06

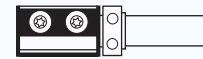

HW FLUSH INSERT TRIMMING BITS Z=2
Page 9.06



HW INSERT PLUNGE
ROUTER BITS Z=1 "VERSOFIX"
Page 9.07

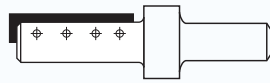

HW INSERT PLUNGE ROUTER BITS Z=1
"VERSOFIX"
Page 9.07

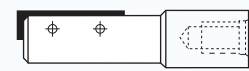

HW INSERT PLUNGE ROUTER BITS Z=1
"VERSOFIX"
Page 9.07



HW INSERT FLUSH TRIM
BITS Z=2 "VERSOFIX"
Page 9.07



HW INSERT FLUSH TRIM
BITS Z=2 "VERSOFIX"
Page 9.07

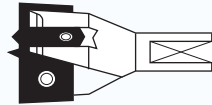

HW INSERT BORING BITS Z=2+2
Page 9.08

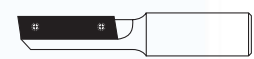

HW INSERT PLUNGE
ROUTER CUTTERS Z=1
Page 9.08

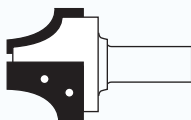

HW INSERT PROFILE CUTTERS, GROUP 1
Page 9.09

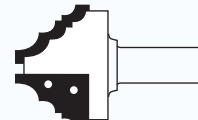

HW INSERT PROFILE CUTTERS, GROUP 2
Page 9.09

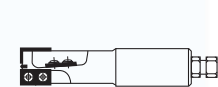

HW INSERT COMPRESSION
ROUTER CUTTERS
Page 9.09

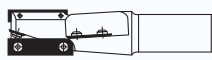

HW INSERT COMPRESSION
ROUTER CUTTER
Page 9.09

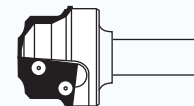

HW INSERT ROUTER BITS FOR
CABINET DOORS Z=2
Page 9.10

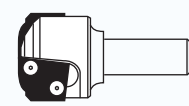

HW INSERT ROUTER BITS FOR
CABINET DOORS Z=2
Page 9.10

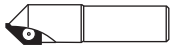

HW INSERT ROUTER BITS FOR
DECORATION AND ENGRAVING Z=1
Page 9.11



COMPLETE SET FOR DECORATING
AND ENGRAVING
Page 9.11



COMPLETE CUTTERS SET FOR
CABINET DOORS
Page 9.12

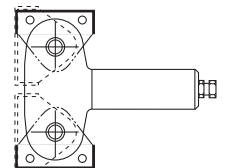

HW INSERT VARI-ANGLE ROUTER
CUTTERS 1° Z=2
Page 9.13

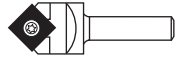

HW INSERT ROUTER BITS FOR
ENGRAVINGS Z=1
Page 9.13

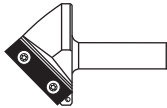

HW INSERT ROUTER BITS FOR
ENGRAVINGS Z=2
Page 9.13

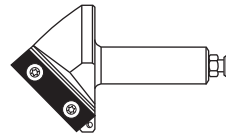

HW INSERT V-GROOVE ROUTER BITS Z=1
Page 9.13



HW INSERT ROUTER BITS
FOR LOCKS Z=2
Page 9.14



HW INSERT ROUTER BITS FOR LOCKS
Z=2 HEAVY METAL TOOL BODY
Page 9.14

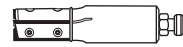

HW INSERT ROUTER BITS LOCKS Z=3
Page 9.14

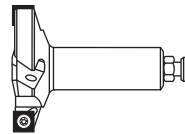

HW INSERT ROUTER BITS FOR PLANING
AND RABBETING Z=2+2
Page 9.14

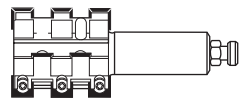

HW INSERT ROUTER CUTTERS,
ROUGHING Z=4
Page 9.15

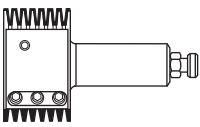

HW INSERT FINGER JOINT
ROUTER CUTTERS Z=2
Page 9.15

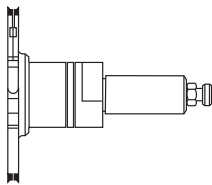

HW INSERT ADJUSTABLE ROUTER
CUTTERS FOR GROOVING
Page 9.15

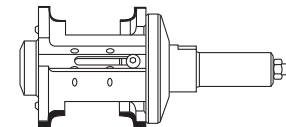

HW INSERT ROUTER BITS FOR ROUNDING
AND CHAMFERING Z=2
Page 9.15



HW INSERT FLUSH TRIMMING
BITS Z=1
Page 9.16

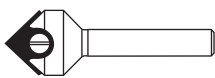

HW INSERT V-GROOVING BITS Z=1
Page 9.16

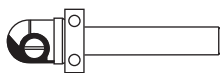

HW INSERT CORE BOX BITS
WITH UPPER BALL BEARING Z=1
Page 9.16



HW INSERT FLUSH TRIMMING BITS
WITH BALL BEARING
Page 9.16

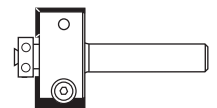

HW INSERT FLUSH TRIMMING BITS
WITH BALL BEARING Z=2
Page 9.16

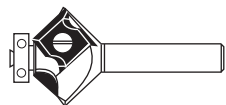

HW INSERT FLUSH TRIMMING BITS
WITH BALL BEARING Z=2
Page 9.17

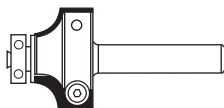

HW INSERT CORNER ROUNDING BITS
WITH BALL BEARING Z=2
Page 9.17

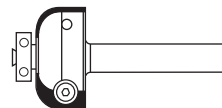

HW INSERT COVER BITS WITH
BALL BEARING Z=2
Page 9.17

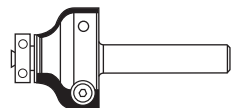

HW INSERT OGEE BITS WITH BALL
BEARING Z=2
Page 9.17



6 PIECE INSERT ROUTER BITS "SET"
Page 9.17



6 PIECE INSERT ROUTER BITS "SET"
Page 9.17



HW INSERT ROUTER BITS Z=2+1
Page 9.18



HW INSERT ROUTER BITS Z=2
Page 9.18

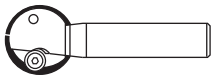

HW INSERT BALL SLOT ROUTER BITS Z=2
Page 9.18

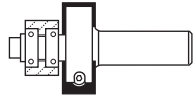

HW INSERT REBATE BITS Z=2
Page 9.18

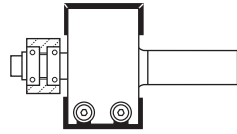

HW INSERT REBATE BITS Z=2
Page 9.19

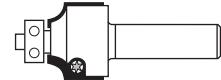

HW INSERT BEADING BITS Z=2
Page 9.19

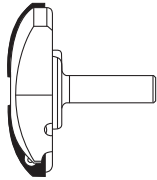

HW INSERT PROFILE RAISED PANEL
ROUTER CUTTERS Z=2
Page 9.19

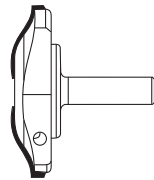

HW INSERT PROFILE RAISED PANEL
ROUTER CUTTERS Z=2
Page 9.19

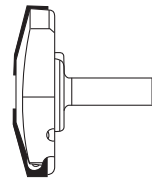

HW INSERT PROFILE RAISED PANEL
ROUTER CUTTERS Z=2
Page 9.20

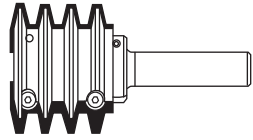

HW INSERT FINGER JOINT
ROUTER CUTTERS Z=2
Page 9.20

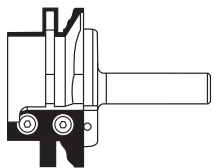

HW INSERT COUNTER-PROFILE
CUTTERS Z=2
Page 9.20

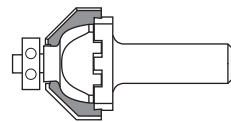

HW INTERCHANGEABLE INSERT
ROUTER BITS "NOVA SYSTEM" Z=2
Page 9.21 ÷ 9.23

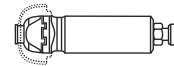

HW INSERT ROUTER BITS
"NOVA SYSTEM" Z=2
Page 9.24

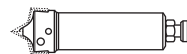

HW INSERT ROUTER BITS
"NOVA SYSTEM" Z=2
Page 9.24

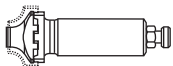

HW INSERT ROUTER BITS
"NOVA SYSTEM" Z=2
Page 9.24



DP ROUTER BITS
Page 9.25



DP ROUTER BITS
Page 9.25



DP ROUTER BITS
Page 9.25



DP ROUTER BITS Z=1
Page 9.26



DP ROUTER BITS Z=1
Page 9.26



DP DOWEL DRILLS
Page 9.26



DP THROUGH-HOLE DRILL BITS
Page 9.26

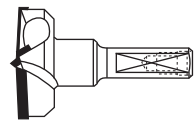

DP HINGE BORING BITS
Page 9.26

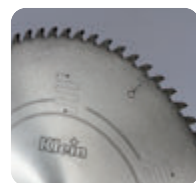

DP SAWBLADES
Page 9.27

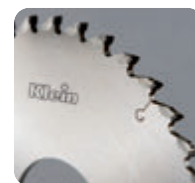

DP CONICAL SCORING SAWBLADES
Page 9.27

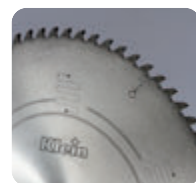

DP PANEL SIZING SAWBLADES
Page 9.28

HW INSERT FLUSH TRIM BITS Z=2

ART. W101 - W102

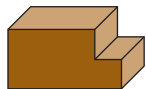
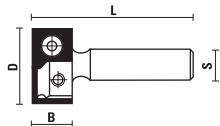

S Ø 6	S Ø 8	D	B	L
W101.190.R	W102.190.R	19	12	55



HW INSERT FLUSH TRIM BITS WITH BALL BEARING GUIDE Z=2

ART. W107 - W108

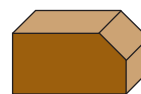
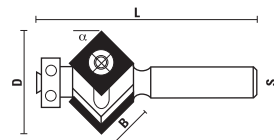

S Ø 6	S Ø 8	D	α	B	L
W107.220.R	W108.220.R	22	10°	12	55
W107.240.R	W108.240.R	24	22°	12	55
W107.260.R	W108.260.R	26	30°	12	55



W107.290.R	W108.290.R	29	45°	12	55
------------	------------	----	-----	----	----

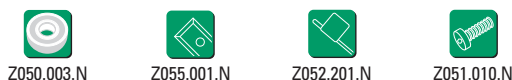

HW INSERT ANGLE BITS Z=2

ART. W103 - W104

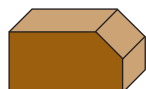
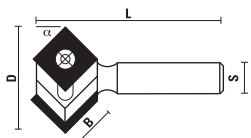

S Ø 6	S Ø 8	D	α	B	L
W103.240.R	W104.240.R	24	22°	12	55
W103.260.R	W104.260.R	26	30°	12	55
W103.290.R	W104.290.R	29	45°	12	55



HW INSERT FLUSH BITS Z=2+1

ART. W109 - W110

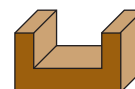
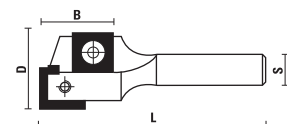

With T.C.T. plunging edge

S Ø 6	S Ø 8	D	B	L
W109.160.R		16	20	50
	W110.160.R	16	20	70
W109.180.R	W110.180.R	18	20	50
W109.200.R	W110.200.R	20	20	50
W109.220.R	W110.220.R	22	20	50



HW INSERT FLUSH TRIM BITS WITH BALL BEARING GUIDE Z=2

ART. W105 - W106

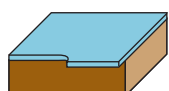
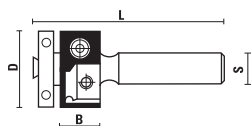

S Ø 6	S Ø 8	D	B	L
W105.190.R	W106.190.R	19	12	65



HW INSERT FLUSH BITS Z=2+1

ART. W111 - W112

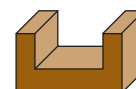
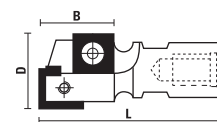

With T.C.T. plunging edge

S M12x1	S M10x1,5	D	B	L
W111.150.R	W112.150.R	15	20	65
W111.160.R	W112.160.R	16	20	65
W111.180.R	W112.180.R	18	20	65
W111.200.R	W112.200.R	20	20	65
W111.220.R	W112.220.R	22	20	65



HW INSERT FLUSH TRIMMING BITS Z=2

ART. W113 - W114

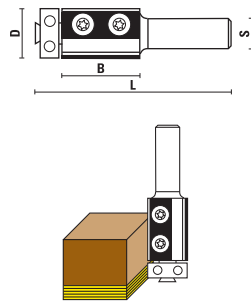

Lower ball bearing

Item	D	B	L	Z	S
W113.190.R	19	30	70	2	8
W114.190.R	19	30	80	2	12
W114.191.R	19	50	100	2	12

Z050.006.N	Z052.201.N	Z055.008.N (B=30)	Z055.010.N (B=50)	Z051.010.R

HW INSERT FLUSH TRIMMING BITS Z=2

ART. W115 - W116

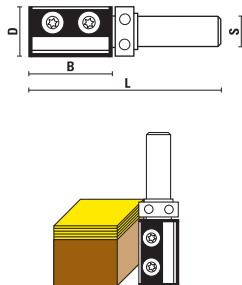

Upper ball bearing

Item	D	B	L	Z	S
W115.190.R	19	30	70	2	8
W116.190.R	19	30	80	2	12
W116.191.R	19	50	100	2	12

Z050.012.N	Z052.201.N	Z055.008.N (B=30)	Z055.010.N (B=50)	Z051.010.R

VERSOFIX CUTTERS AND KNIVES

The best single flute replaceable tip straight cutters

The **VERSOFIX** tools and relating replaceable tips, due to their special design, give excellent result in high volume production and are suitable for use in all types of machines

The insert knives are treated with a special coating ensuring the possibility to work also tough materials, i.e. laminated worktops or glass-reinforced plastic panels.

In the solid wood working there isn't any better solution when working with cutters with small shank diameter (Ø8, Ø10, Ø12).

The "**Kawedur**" coating ensures a better chip flow and makes the life of the knives minimum twice longer than any other type of coating (TIN/TIC).

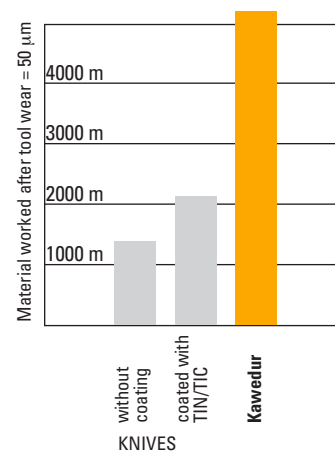
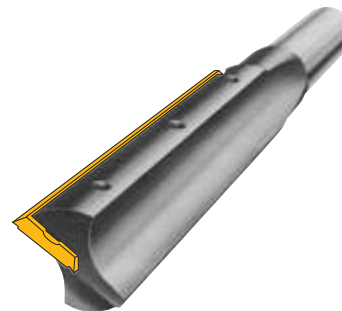

WORKING:

melamine coated chipboard

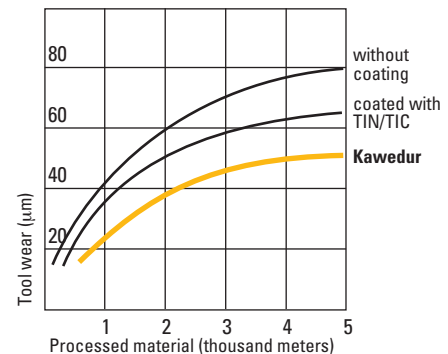

WORKING PARAMETERS:

RPM n=18.000
 Cutting speed vs=14,5 m/sec
 Feed speed vf=6 m/min

HW INSERT PLUNGE ROUTER BITS Z=1 "VERSOFIX"

ART. W120 - W121 - W122

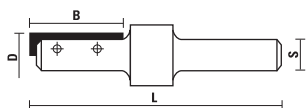

HW knives with "Kawedur" coating

S Ø 6	S Ø 6,35	S Ø 8	D	B	L
W120.080.R	W121.080.R	W122.080.R	8	20	63
W120.100.R	W121.100.R	W122.100.R	10	20	63
W120.120.R	W121.120.R	W122.120.R	12	20	63
W120.140.R	W121.140.R	W122.140.R	14	20	59
W120.150.R	W121.150.R	W122.150.R	15	20	59
W120.160.R	W121.160.R	W122.160.R	16	20	59
W120.180.R	W121.180.R	W122.180.R	18	20	59
W120.200.R	W121.200.R	W122.200.R	20	20	59
W120.220.R	W121.220.R	W122.220.R	22	20	59

HW INSERT PLUNGE ROUTER BITS Z=1 "VERSOFIX"

ART. W123 - W124 - W125

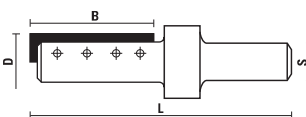

HW knives with "Kawedur" coating

S Ø 10x35	S Ø 12x35	S Ø 12,7x35	D	B	L
W123.080.R	W124.080.R	W125.080.R	8	20	68
W123.100.R	W124.100.R	W125.100.R	10	20	68
W123.120.R	W124.120.R	W125.120.R	12	20	68
		W125.127.R	12,7	30	74
W123.140.R	W124.140.R	W125.140.R	14	30	74
W123.141.R	W124.141.R	W125.141.R	14	50	94
W123.150.R	W124.150.R	W125.150.R	15	30	74
W123.160.R	W124.160.R	W125.160.R	16	30	74
W123.161.R	W124.161.R	W125.161.R	16	50	94
W123.180.R	W124.180.R	W125.180.R	18	30	74
W123.181.R	W124.181.R	W125.181.R	18	50	94
W123.200.R	W124.200.R	W125.200.R	20	30	74
W123.201.R	W124.201.R	W125.201.R	20	50	94
W123.220.R	W124.220.R	W125.220.R	22	30	74



Z052.101.N (For D=8:12)



Z052.102.N (For D=14)



Z055.220.N (For D=8:12)
Z055.221.N (For D=14:22)
Z055.230.N (For D=12,2:13,9)
Z055.231.N (For D=14:22)
Z055.250.N (For D=14:22)



Z051.101.R (For D=8:12,7)



Z051.102.R (For D=14:22)

HW INSERT PLUNGE ROUTER BITS Z=1 "VERSOFIX"

ART. W126 - W127

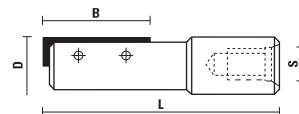

HW knives with "Kawedur" coating

M10x1,5	M12x1	D	B	L
W126.080.R	W127.080.R	8	20	58
W126.100.R	W127.100.R	10	20	58
W126.120.R	W127.120.R	12	20	58
W126.140.R	W127.140.R	14	30	65
W126.141.R	W127.141.R	14	50	85
W126.150.R	W127.150.R	15	30	65
W126.160.R	W127.160.R	16	30	65
W126.161.R	W127.161.R	16	50	85
W126.180.R	W127.180.R	18	30	65
W126.181.R	W127.181.R	18	50	85
W126.200.R	W127.200.R	20	30	65
W126.201.R	W127.201.R	20	50	85
W126.220.R	W127.220.R	22	30	65

HW INSERT FLUSH TRIM BITS Z=2 "VERSOFIX"

ART. W138

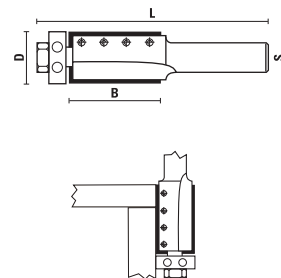

- HW knives with "Kawedur" coating
- For CORIAN®
- Ball bearing with Delrin® ring

S Ø 12	D	B	L
W138.190.R	19	30	82



Z050.111.N



Z055.230.N



Z051.101.R

HW INSERT FLUSH TRIM BITS Z=2 "VERSOFIX"

ART. W138

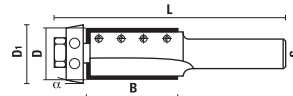

- HW knives with "Kawedur" coating
- For CORIAN®
- 11° ball bearing with Delrin® ring

S Ø 12	D	D1	B	L	α
W138.220.R	19	22	30	82	11°



Z050.110.N



Z055.230.N



Z051.101.R

HW INSERT BORING BITS Z=2+2

ART. W140

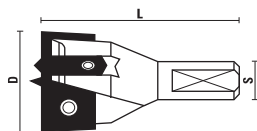

RH rotation	LH rotation	D	L	S	Spare knife
W140.250.R	W140.250.L	25	57	10x26	Z055.125.N
W140.260.R	W140.260.L	26	57	10x26	Z055.126.N
W140.300.R	W140.300.L	30	57	10x26	Z055.130.N
W140.350.R	W140.350.L	35	57	10x26	Z055.135.N
W140.400.R	W140.400.L	40	57	10x26	Z055.140.N



Z051.010.R
Screw for knives



Z051.011.R
Screw for spurs



Z051.304.R
Screw for centre point



Z055.100.N



Z055.101.N



Z052.201.N

HW INSERT PLUNGE ROUTER CUTTERS Z=1

ART. W153

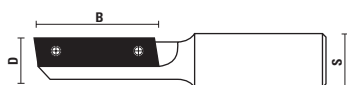

Spare knives suitable for plunging

RH rotation	D	B	S	Z
W153.120.R	12	22	∅20x40	1
W153.140.R	14	22	∅20x40	1



Z055.423.N (B=30)



Z051.210.R



Z052.201.N

HW INSERT PLUNGE ROUTER CUTTERS Z=1

ART. W155

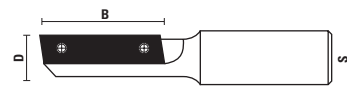

Spare knives suitable for plunging

Item	D	B	S	Z
W155.160.R	16	30	∅20x50	1
W155.161.R	16	50	∅20x50	1
W155.180.R	18	30	∅20x50	1
W155.181.R	18	50	∅20x50	1
W155.200.R	20	30	∅20x50	1
W155.201.R	20	50	∅20x50	1
W155.220.R	22	30	∅20x50	1
W155.221.R	22	50	∅20x50	1



Z055.425.N (B=50 D=16)
Z055.430.N (B=30)
Z055.450.N (B=50)



Z051.210.R (B=30)



Z051.211.R (B=50)



Z052.201.N

HW INSERT PROFILE CUTTERS, GROUP 1

ART. W160

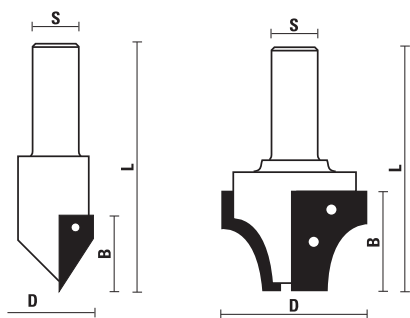

- From $\varnothing 20$ to $\varnothing 39$ z=1
- From $\varnothing 40$ to $\varnothing 80$ z=2

D	B	D	B
20	25	60	30
		60	40
30	25	60	50
30	30		
40	20	70	30
40	30	70	40
40	40	70	50
50	30	80	30
50	40	80	40
50	50	80	50

SPARE KNIVES QUOTED ON REQUEST

Price depends on the diameter and length of the cutters.
For a specific quote a detailed drawing or a sample are required.

HW INSERT PROFILE CUTTERS, GROUP 2

ART. W161

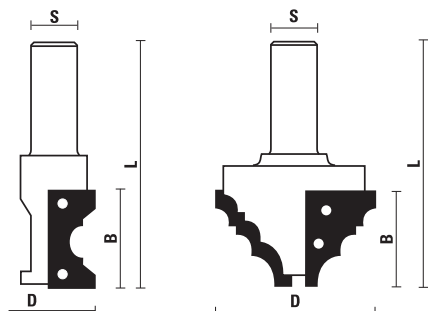

- From $\varnothing 20$ to $\varnothing 39$ z=1
- From $\varnothing 40$ to $\varnothing 80$ z=2

D	B	D	B
20	25	60	30
		60	40
30	25	60	50
30	30		
		70	30
40	20	70	40
40	30	70	50
40	40		
		80	30
50	30	80	40
50	40	80	50
50	50		

SPARE KNIVES QUOTED ON REQUEST

Price depends on the diameter and length of the cutters.
For a specific quote a detailed drawing or a sample are required.

HW INSERT COMPRESSION ROUTER CUTTERS

ART. W165

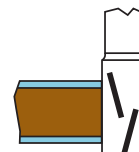
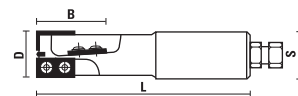

- Axial angle positive and negative compression bits
- HW plunging tip

Item	D	B	L	S	Z
W165.200.R	20	30	110	25x55	2+2+1
W165.201.R	20	50	125	25x55	2+2+1
W165.202.R	20	30	134	MK2 - M 30x1,5	2+2+1
W165.203.R	20	50	157	MK2 - M 30x1,5	2+2+1



Z051.308.R



Z052.302.N



Z055.516.N (B=30)
Z055.528.N (B=50)

HW INSERT COMPRESSION ROUTER CUTTERS

ART. W165

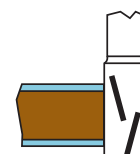
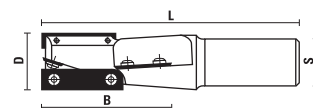

- Axial angle positive and negative compression bits
- With spare knife for plunging

Item	D	B	L	S	Z
W165.300.R	30	75	145	25x55	2+2+1



Z051.210.R



Z052.201.N



Z055.341.N



Z055.000.N

HW INSERT ROUTER BITS FOR CABINET DOORS Z=2

ART. W160

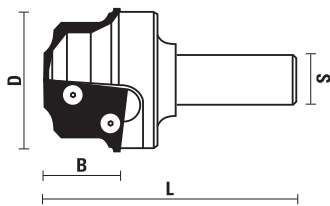

PROFILE A1

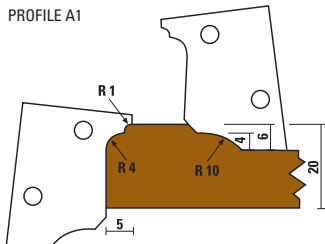

PROFILE A2

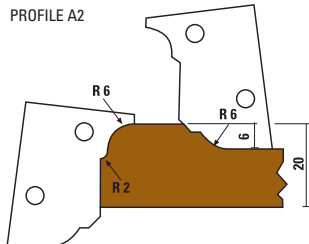

PROFILE A3

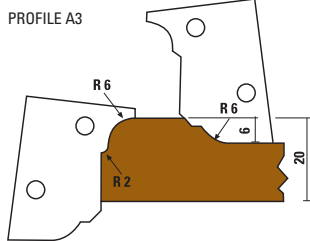

PROFILE A4

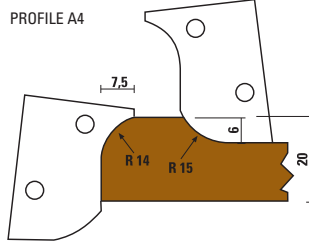

PROFILE A5

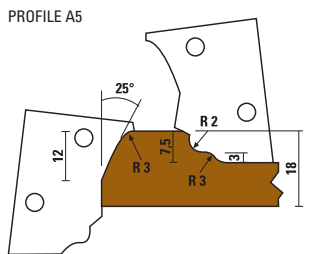

PROFILE A6

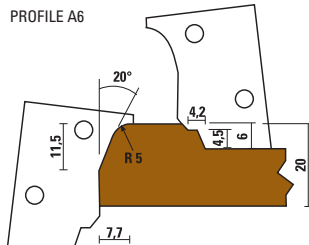

- With reversible knives
- For producing either the external or internal moulding

Item	D	B	L	S	Profile
W160.601.R	60	40	100	20x50	A1
W160.602.R	60	40	100	20x50	A2
W160.603.R	60	40	100	20x50	A3
W160.604.R	60	40	100	20x50	A4
W160.605.R	60	40	100	20x50	A5
W160.606.R	60	40	100	20x50	A6

Spare parts

Tool body without knives

W160.600.R



Z051.010.R



Z055.661.N (A1)
Z055.662.N (A2)
Z055.663.N (A3)
Z055.664.N (A4)
Z055.665.N (A5)
Z055.666.N (A6)



Z052.201.N

HW INSERT ROUTER BITS FOR CABINET DOORS Z=2

ART. W161

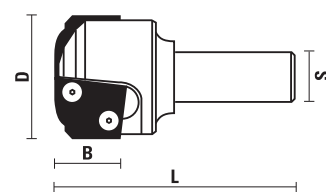

PROFILE B1

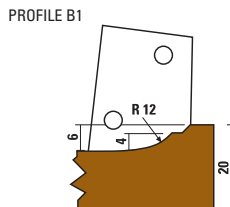

PROFILE B2

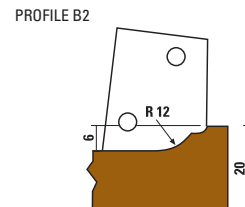

PROFILE B3

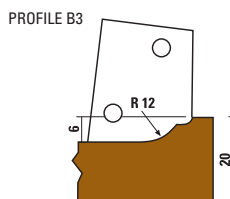

PROFILE B4

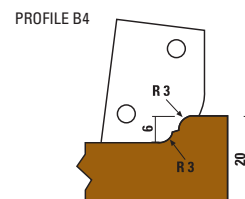

PROFILE B5

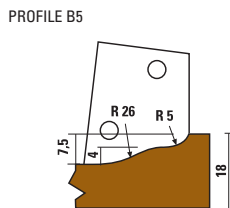

PROFILE B6

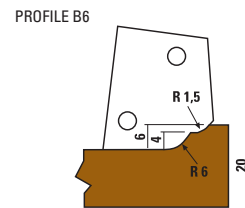

- With reversible knives
- For producing the internal moulding

Item	D	B	L	S	Profile
W161.501.R	50	25	95	20x50	B1
W161.502.R	50	25	95	20x50	B2
W161.503.R	50	25	95	20x50	B3
W161.504.R	50	25	95	20x50	B4
W161.505.R	50	25	95	20x50	B5
W161.506.R	50	25	95	20x50	B6

Spare parts

Tool body without knives

W161.500.R



Z051.010.R



Z055.651.N (B1)
Z055.652.N (B2)
Z055.653.N (B3)
Z055.654.N (B4)
Z055.655.N (B5)
Z055.656.N (B6)



Z052.201.N

HW INSERT ROUTER BITS FOR DECORATION AND ENGRAVING Z=1

ART. W162

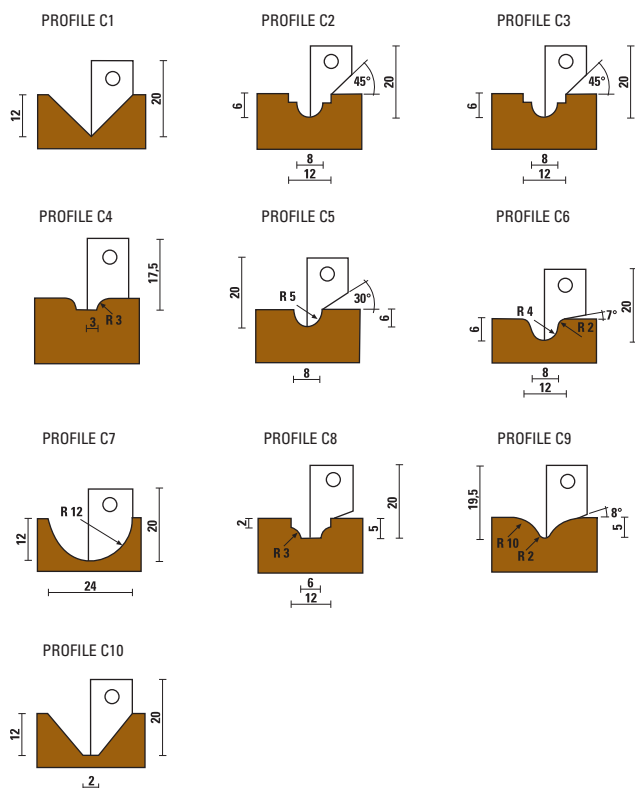
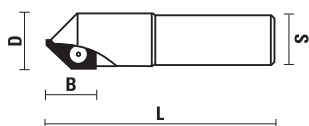

With reversible knives

Item	D	B	L	S	Profile
W162.241.R	24	20	95	20x50	C1
W162.242.R	24	20	95	20x50	C2
W162.243.R	24	20	95	20x50	C3
W162.244.R	24	20	95	20x50	C4
W162.245.R	24	20	95	20x50	C5
W162.246.R	24	20	95	20x50	C6
W162.247.R	24	20	95	20x50	C7
W162.248.R	24	20	95	20x50	C8
W162.249.R	24	20	95	20x50	C9
W162.250.R	24	20	95	20x50	C10

Spare parts

Tool body without knives

W162.240.R



Z051.010.R



Z055.641.N (C1)
Z055.642.N (C2)
Z055.643.N (C3)
Z055.644.N (C4)
Z055.645.N (C5)
Z055.646.N (C6)
Z055.647.N (C7)
Z055.648.N (C8)
Z055.649.N (C9)
Z055.650.N (C10)



Z052.201.N

COMPLETE SET FOR DECORATING AND ENGRAVING

ART. XW162

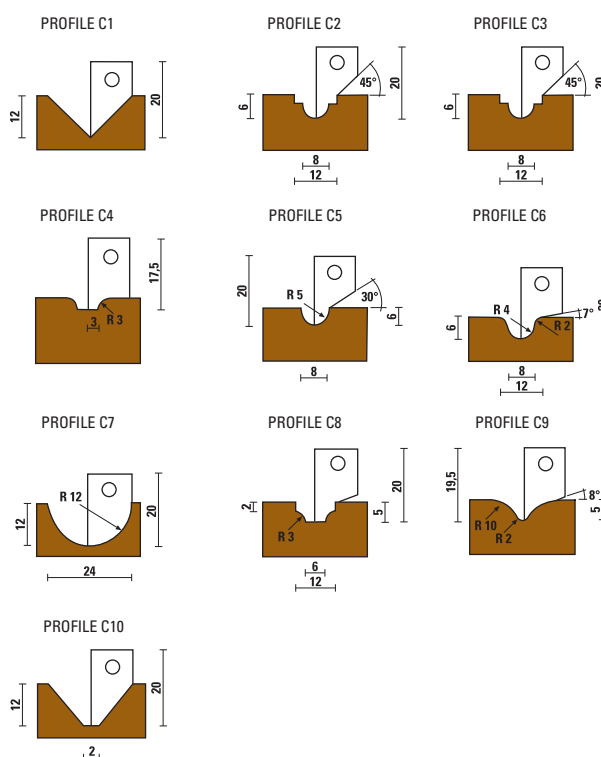

- Set includes a tool body with nr. 10 profiled knives
- With reversible knives
- Z=1
- In plastic case

Item

XW162.001.N

complete with:

W162.250.R

Spare knife	Dimension	Profile
Z055.641.R	45°	C1
Z055.642.R	R4/45°	C2
Z055.643.R	R1/R11	C3
Z055.644.R	R3	C4
Z055.645.R	R8/30°	C5
Z055.646.R	R4/R2	C6
Z055.647.R	R12	C7
Z055.648.R	R3/2	C8
Z055.649.R	R2/R10	C9
Z055.650.R	45°/2	C10



Z051.010.R



Z052.201.N

COMPLETE CUTTERS SET FOR CABINET DOORS

ART. XW160



Set including 3 cutters with HW knives

PROFILE EXAMPLES

Item

XW160.001.N including: W160.601.R + W161.501.R + W162.241.R

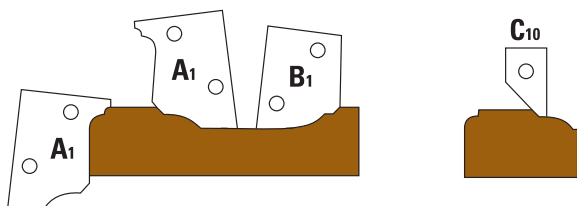

Item

XW160.002.N including: W160.602.R + W161.502.R + W162.241.R

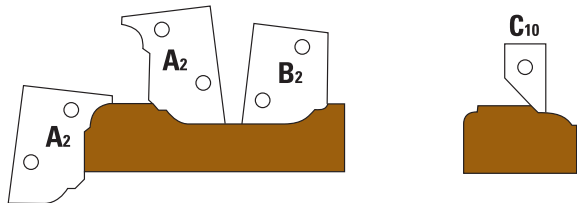

Item

XW160.003.N including: W160.603.R + W161.503.R + W162.241.R

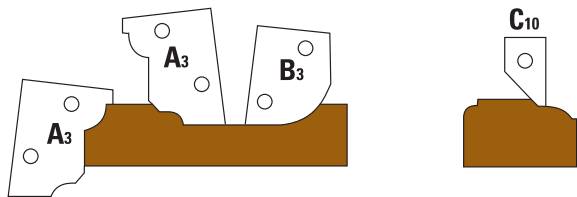

Item

XW160.004.N including: W160.605.R + W161.505.R + W162.241.R

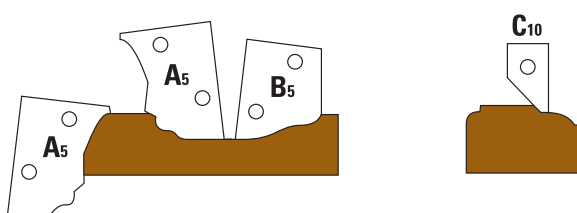

Item

XW160.005.N including: W160.606.R + W161.506.R + W162.241.R

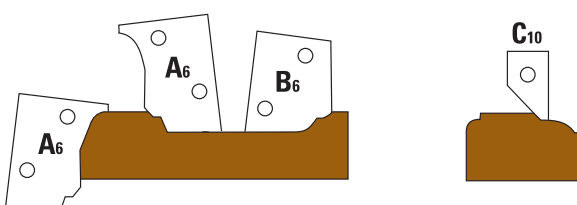

PROFILE EXAMPLE

Item **W160**

Execution nr. 1 and 2

Working with the same cutter you can produce either the external (nr. 1 - routing) or internal - (nr. 2 - profiling) profile

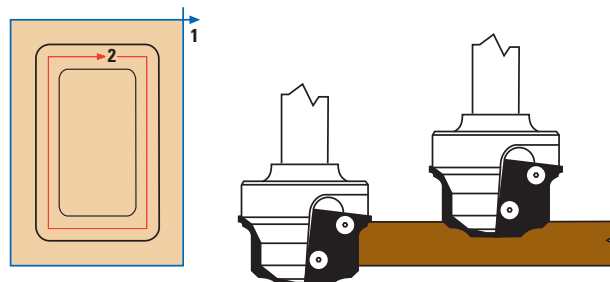

Item **W161**

Execution nr. 3

Profiling the internal side

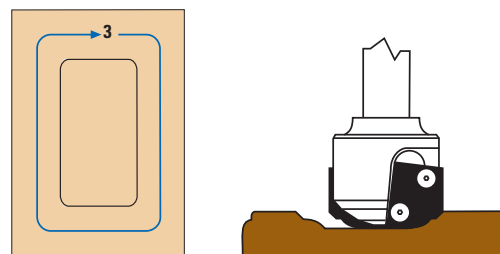

Item **W162**

Execution nr. 4 and 5

This cutter is used to work the decoration on top and can be used with different profiled knives

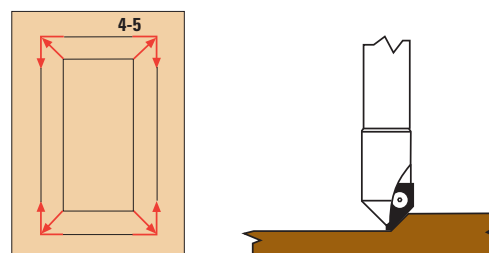

HW INSERT VARI-ANGLE ROUTER CUTTERS 1° Z=2

ART. W168

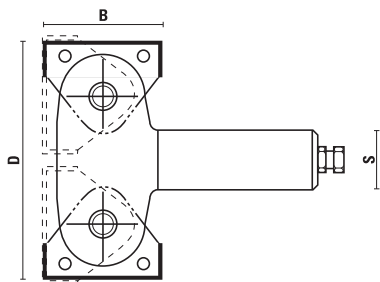

- Adjustable 0° - 45° top
- Adjustable 0° - 90° bottom
- Adjustable by 1 degree

Item	D	B	Z	S
W168.085.R	85	40	2	25x55
W168.185.R	85	40	2	20x55

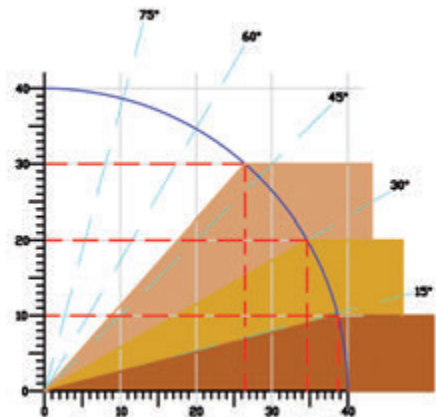
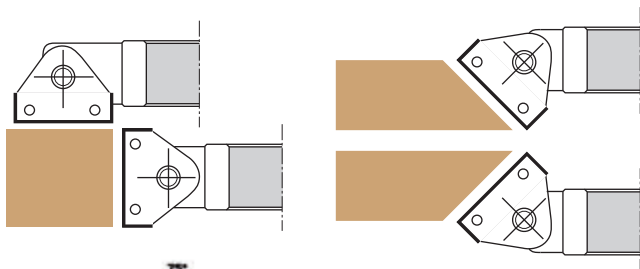
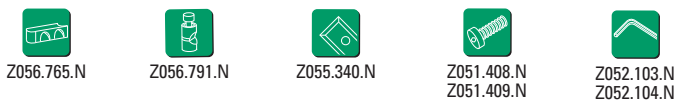

HW INSERT ROUTER BITS FOR ENGRAVINGS Z=1

ART. W170

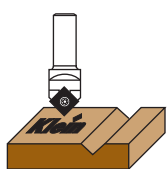
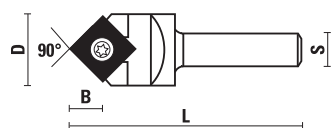

Used on handportable machines, CNC routers and machining centres

Item	D	B	L	Z	S
W170.170.R	17	8,4	60	1	12



HW INSERT ROUTER BITS FOR ENGRAVINGS Z=2

ART. W170

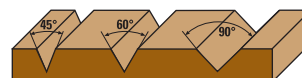
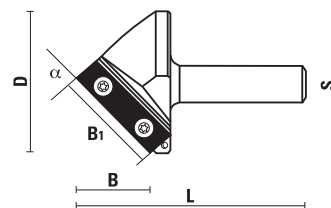

Used on handportable machines, CNC routers and machining centres

Item	D	α	B	B1	L	S
W170.210.R	21	45°	25	27	61	12
W170.260.R	26	60°	23	27	61	12
W170.380.R	38	90°	19	27	76	12



HW INSERT V-GROOVE ROUTER BITS Z=1

ART. W171

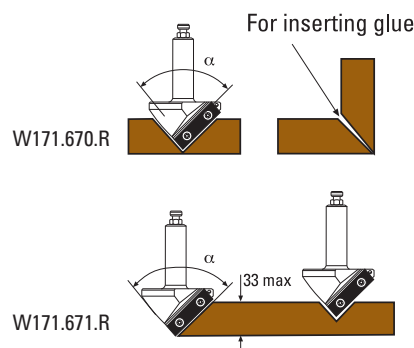
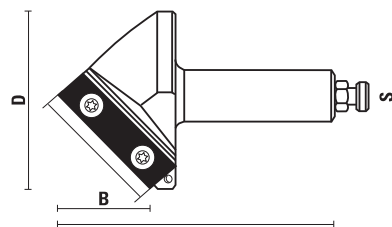

Used on CNC routers and machining centres

Item	D	B	B1	L	S	α
W171.670.R	67	33	46,5	97	20	91°
W171.671.R NEW	67	33	46,5	97	20	90°



HW INSERT ROUTER BITS FOR LOCKS Z=2

ART. W172 - W173

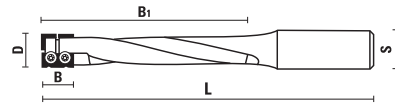

Used on CNC routers and machining centres

Item	D	B	B ₁	L	S
W172.160.R	16	16	115	170	16x55
W172.161.R	16	23	105	150	16x45
W172.180.R	18	16	115	170	16x55
W173.160.R	16	16	115	170	20x55
W173.161.R	16	23	115	170	20x55
W173.180.R	18	16	115	170	20x55



Z051.308.R



Z052.302.N



Z055.501.N
Z055.502.N
(16x7x1,5)



Z055.503.N
Z055.504.N
(23x7x1,5)

HW INSERT ROUTER BITS FOR LOCKS Z=2 HEAVY METAL TOOL BODY

ART. W172 - W173

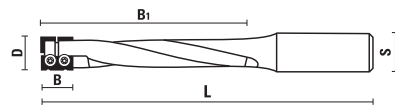

- Used on CNC routers and machining centres
- Heavy metal tool body
- Low-vibration machining
- Reduced risk of tool breakage

Item	D	B	B ₁	L	S
W172.160.RAP NEW	16	16	115	170	16x55



Z051.308.R



Z052.302.R



Z055.501.N
Z055.502.N

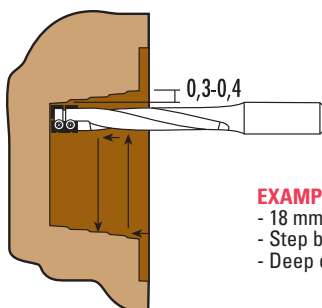

EXAMPLE OF USE:

- 18 mm: n. 12.000-20.000 min⁻¹
- Step by step cutting 0,3-0,4 mm
- Deep cutting with excellent chip flow

HW INSERT ROUTER BITS Z=3

ART. W174 - W175

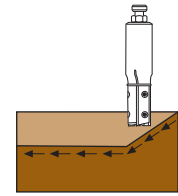
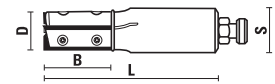

- Extremely silent
- Improved balancing compared with traditional system
- Used on CNC routers and machining centres
- **NO CUTTING EDGE FOR BORING**

Item	Rotat.	D	B	L	S
W174.180.R	Dx	18	50	102	20
W174.180.L	Sx	18	50	102	20

W175.180.R	Dx	18	50	102	25
W175.180.L	Sx	18	50	102	25



Z051.404.R



Z052.007.N



Z055.500.R
Z055.500.L

HW INSERT ROUTER BITS FOR PLANING AND RABBETING Z=2+2

ART. W176 - W177

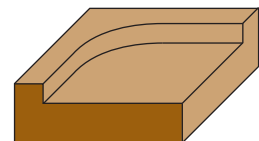
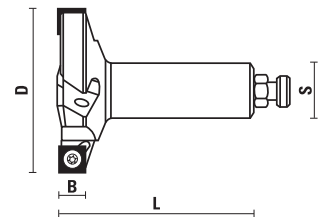

- Ideal for removing material over large surface areas
- Used on CNC routers and machining centres

Item	D	B	L	S
W176.800.R	80	12	90	20

W177.800.R	80	12	90	25
------------	----	----	----	----



Z051.402.R



Z051.403.R



Z052.201.N



Z055.001.N
knife



Z055.007.N
spur

HW INSERT ROUTER CUTTERS, ROUGHING Z=4

ART. W178 - W179

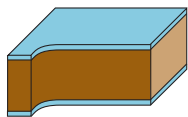
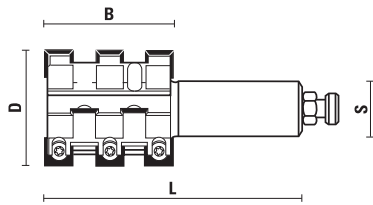

- Multi cutting flutes router cutter 12x12x1,5
- Used on CNC routers and machining centres

Item	D	B	L	S	Z
W178.500.R	50	56	113	20	4
W178.501.R	50	78	135	20	4

W179.500.R	50	56	113	25	4
W179.501.R	50	78	135	25	4



Z051.400.R



Z052.201.N



Z055.001.N

HW INSERT FINGER JOINT ROUTER CUTTERS Z=2

ART. W180 - W181

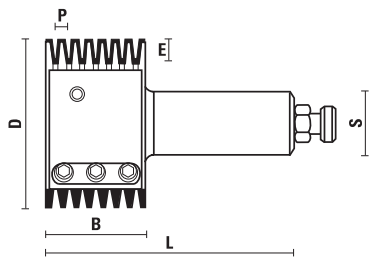

Used on CNC routers and machining centres

Item	D	B	L	P	E	S
W180.700.R	70	40	100	5,4	8	20

W181.700.R	70	40	100	5,4	8	25
------------	----	----	-----	-----	---	----



Z051.401.R



Z052.003.N



Z055.628.N



Z056.100.N



Z056.101.N

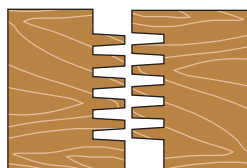

HW INSERT ADJUSTABLE ROUTER CUTTERS FOR GROOVING

ART. W182 - W183

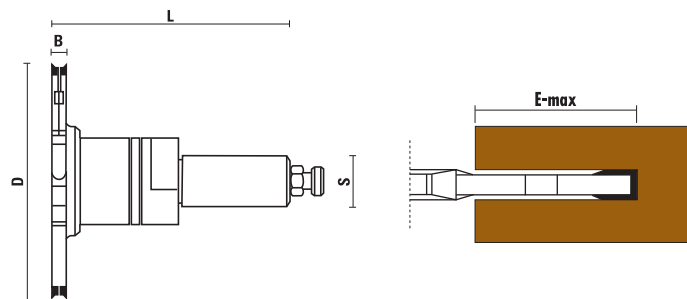

- Suitable for producing different thickness grooves
- Thickness adjustable in 0,1 mm steps by means of spacers
- Used on CNC routers and machining centres
- Can be produced with HSK or ISO30 shank on request

Item	D	B	L	S	E-max
W182.120.R	120	4÷15,5	140	20	33

W183.120.R	120	4÷15,5	140	25	33
------------	-----	--------	-----	----	----



Z051.405.R



Z051.406.R



Z055.006.N



Z055.000.N



Z057.100.N



Z052.006.N



Z052.302.N



Z060.750.N



Z060.751.N



Z056.102.N

HW INSERT ROUTER BITS FOR ROUNDING AND CHAMFERING Z=2

ART. W184 - W185

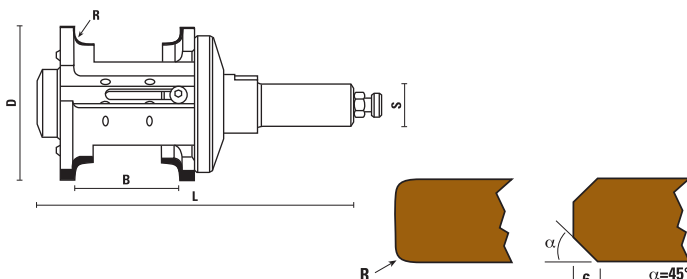

- For corner rounding and chamfering with single pass
- Different radii or 45° chamfers
- Adjustable for various wood thicknesses
- Used on CNC routers and machining centres

Item	D	R	B	L	S
W184.903.R	90	3	18÷58	185	20

W184.904.R	90	4	18÷58	185	20
------------	----	---	-------	-----	----

W184.905.R	90	5	18÷58	185	20
------------	----	---	-------	-----	----

W184.906.R	90	6	18÷58	185	20
------------	----	---	-------	-----	----

W184.908.R	90	8	20÷60	185	20
------------	----	---	-------	-----	----

W184.910.R	90	10	22÷62	185	20
------------	----	----	-------	-----	----

W184.945.R	90	45°	12÷62	185	20
------------	----	-----	-------	-----	----

W185.903.R	90	3	18÷58	185	25
------------	----	---	-------	-----	----

W185.904.R	90	4	18÷58	185	25
------------	----	---	-------	-----	----

W185.905.R	90	5	18÷58	185	25
------------	----	---	-------	-----	----

W185.906.R	90	6	18÷58	185	25
------------	----	---	-------	-----	----

W185.908.R	90	8	20÷60	185	25
------------	----	---	-------	-----	----

W185.910.R	90	10	22÷62	185	25
------------	----	----	-------	-----	----

W185.945.R	90	45°	12÷62	185	25
------------	----	-----	-------	-----	----



Z051.400.R



Z052.201.N



Z055.011.N



Z055.870.R/L
Z055.871.R/L
Z055.872.R/L
Z055.873.R/L
Z055.874.R/L
Z055.875.R/L
Z055.876.R/L

INSERT ROUTER BITS FOR PORTABLE ROUTERS

Always looking for innovative products and most useful solutions, **SISTEMI** has developed a new line of router bits **KLEIN** with interchangeable carbide knives, which have a higher hardness than the tips used in traditional brazed router bits. The main advantages granted by the use of HM reversible knives and the possibility of their easy replacement are:

- **Longer tool life** ⇒ the knives are getting less worn out and in case of damage they can be easily replaced;
- **Better finish quality** ⇒ also working abrasive materials, the cutting edge can be maintained always sharp;
- **Higher measures precision** ⇒ the dimensions of the tools are not changing because there is no resharping;
- **Better Quality/Price ratio** ⇒ higher production efficiency, less costs and better performances;

HW INSERT FLUSH TRIMMING BITS Z=1

ART. WC101

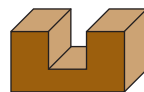
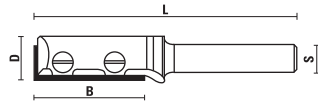

With reversible knives

S ∅ 8	D	B	L
WC101.120.R	12	29,5	66
Z055.330.N	Z051.501.R		

HW INSERT V-GROOVING BITS Z=1

ART. WC109

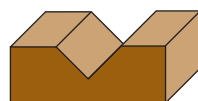
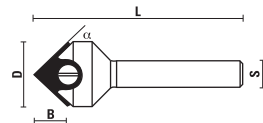

With reversible knives

S ∅ 8	D	B	α	L
WC109.176.R	17,6	8,5	45°	53
Z055.001.N	Z051.501.R			

HW INSERT CORE BOX BITS WITH UPPER BALL BEARING Z=1

ART. WC111

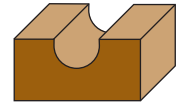
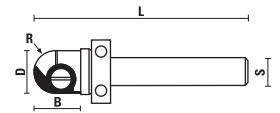

With reversible knives

S ∅ 8	D	B	R	L
WC111.127.R	12,7	13	6	59
Z050.018.N	Z055.550.N	Z051.501.R		

HW INSERT FLUSH TRIMMING BITS WITH BALL BEARING

ART. WC120

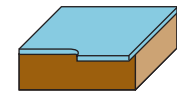
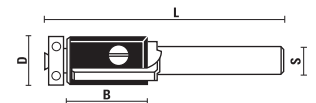

With reversible knives

S ∅ 8	D	B	L	Z
WC120.127.R	12,7	20	62	2
Z050.003.N	Z055.551.N	Z051.503.N Screw for ball bearing	Z051.501.R Screw for knives	

HW INSERT FLUSH TRIMMING BITS WITH BALL BEARING Z=2

ART. WC121

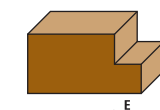
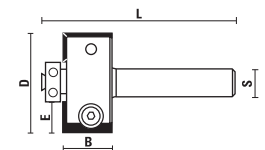

With reversible knives

S ∅ 8	D	B	E	L
WC121.286.R	28,6	13,2	7,95	48
Z050.002.N	Z055.552.N	Z051.503.N Screw for ball bearing	Z051.501.R Screw for knives	

HW INSERT FLUSH TRIMMING BITS WITH BALL BEARING Z=2

ART. WC122

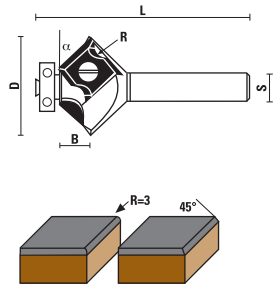

- With reversible knives
- The same knives can be used for both 45° and R= 3 bevel



S Ø 8	D	B	R	α	L
WC122.273.R	27,3	5,7	3	45°	59
Z050.003.N	Z055.553.N	Z051.503.N Screw for ball bearing	Z051.501.R Screw for knives		

HW INSERT COVER BITS WITH BALL BEARING Z=2

ART. WC125

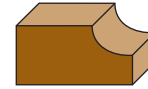
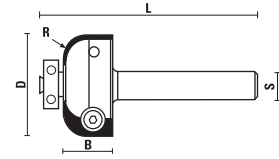

With reversible knives



S Ø 8	D	B	R	L
WC125.260.R	26	12,7	6	55
Z050.003.N	Z055.555.N	Z051.503.N Screw for ball bearing	Z051.501.R Screw for knives	

HW INSERT CORNER ROUNDING BITS WITH BALL BEARING Z=2

ART. WC123

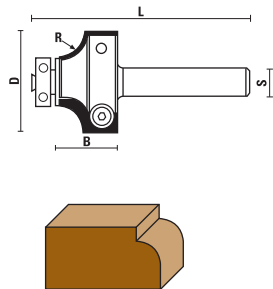

With reversible knives



S Ø 8	D	B	R	L
WC123.260.R	26	15,7	6	55
Z050.003.N	Z055.554.N	Z051.503.N Screw for ball bearing	Z051.501.R Screw for knives	

HW INSERT OGEE BITS WITH BALL BEARING Z=2

ART. WC129

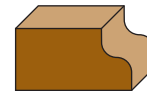
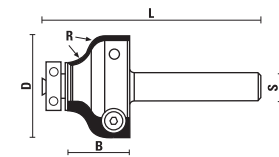

With reversible knives



S Ø 8	D	B	R	L
WC129.260.R	26	15,7	4,5	55
Z050.003.N	Z055.556.N	Z051.503.N Screw for ball bearing	Z051.501.R Screw for knives	

6 PIECE INSERT ROUTER BITS "SET"

ART. XWC



- Set including the 6 most popular HW router bits in S=8 in a robust and practical wooden box.
- Ideal to have always on hand the right bit for straight cuts, trimming and engraving.
- Router bit with reversible knives

See page 1.35

Item
XWC.001.R
6-pcs router bit set:
WC101.120.R - WC109.176.R
WC111.127.R - WC120.127.R
WC121.286.R - WC122.273.R

6 PIECE INSERT ROUTER BITS "SET"

ART. XWC



- Set including the 6 most popular HW router bits in S=8 in a robust and practical wooden box.
- Ideal to have always on hand the right bit for trimming and profiling.
- Router bit with reversible knives

See page 1.35

Item
XWC.002.R
6-pcs router bit set:
WC120.127.R - WC121.286.R
WC122.273.R - WC123.260.R
WC125.260.R - WC129.260.R

HW INSERT ROUTER BITS Z=2+1

ART. WE100

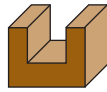
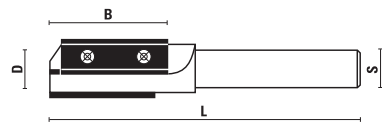

With HW boring tip

S Ø 12	D	B	L
WE100.160.R	16	50	110
WE100.180.R	18	50	110
WE100.200.R	20	50	110
WE100.220.R	22	50	110



Z051.010.R



Z052.201.N



Z055.340.N

HW INSERT ROUTER BITS Z=2

ART. WE101

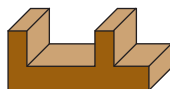
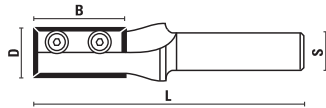

S=1/2" on request art. WG

S Ø 12	D	B	L
WE101.120.R	12	29,5	81
WE101.140.R	14	29,5	86
WE101.160.R	16	29,5	88
WE101.180.R	18	29,5	86
WE101.200.R	20	29,5	86
WE101.220.R	22	29,5	88



Z051.321.R



Z052.007.N



Z055.529.N



Z051.211.R



Z052.201.N



Z055.330.N



Z051.400.R



Z052.201.N



Z055.329.N

HW INSERT BALL SLOT ROUTER BITS Z=2

ART. WE112

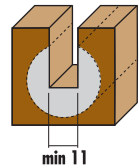
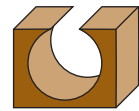
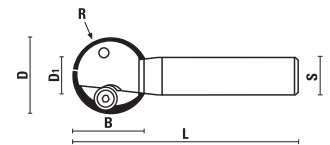

These tools can produce grooves for sliding panels or electrical wires, after a first groove wich allows the tool shank moving

S=1/2" on request art. WG

S Ø 12	D	D1	R	B	L
WE112.127.R	12,7	10	6,4	10	67
WE112.160.R	16	13	8	14	70
WE112.190.R	19	15	9,5	17	67
WE112.254.R	25,4	17	12,7	24	73



Z051.308.R
(D da 12,7 a 19)



Z051.400.R
(D=25,4)



Z052.201.N (Z051.308)
Z052.302.N (Z051.400)



Z055.572.N
Z055.573.N



Z055.574.N
Z055.575.N

HW INSERT REBATE BITS Z=2

ART. WE150

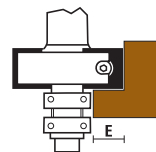
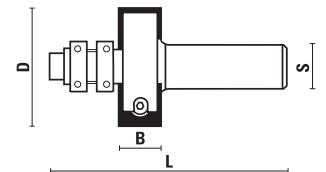

S=1/2" on request art. WG

S Ø 12	D	B	L	E
WE150.380.R	38	12	66	12



Z050.007.N



Z051.400.R



Z052.201.N



Z055.001.N



Z054.410.N



Z054.002.N

HW INSERT REBATE BITS Z=2

ART. WE150

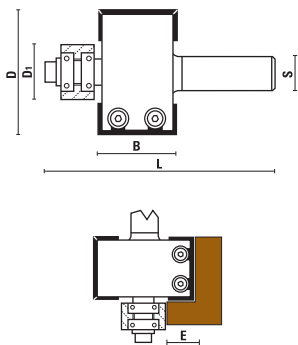

S=1/2" on request art. WG

S Ø 12	D	B	L	E
WE150.510.R	51	29,5	84	16



BEARING RINGS

	D1	E
Z050.901.N	14,31	8,25
Z050.902.N	16	17,5
Z050.903.N	19	16
Z050.904.N	20,6	15,2
Z050.905.N	22,2	14,3
Z050.906.N	25,4	12,7
Z050.907.N	27	12
Z050.908.N	28,6	10
Z050.909.N	31,8	9,5
Z050.910.N	32,5	9,25
Z050.911.N	35	8
Z050.912.N	38	6,4
Z050.913.N	39	6
Z050.914.N	41,3	4,8
Z050.915.N	44,4	3,2
Z050.916.N	47,6	1,6
Z050.999.N	set complete with 16 bearing rings	

HW INSERT BEADING BITS Z=2

ART. WE152

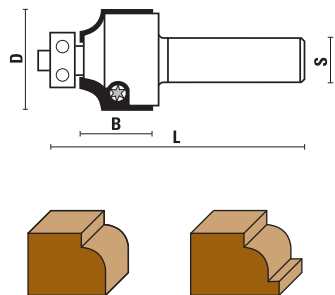

S=1/2" on request art. WG

S Ø 12	D	R	B	L
WE152.250.R	25	20	3	68
WE152.280.R	28	20	6	68
WE152.320.R	32	30	8	78
WE152.360.R	36	30	10	78

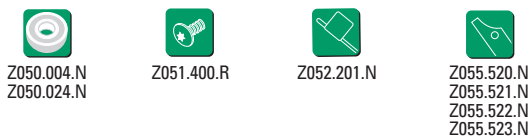

HW INSERT PROFILE RAISED PANEL ROUTER CUTTERS Z=2

ART. WE178

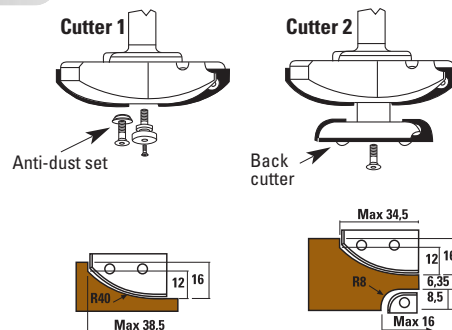
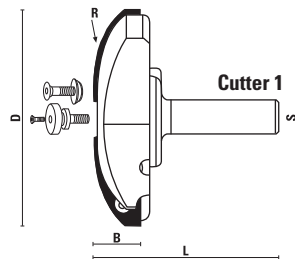

S=1/2" on request art. WG

S Ø 12	D	R	B	L
WE178.860.R - Cutter 1	86	40	21,2	72
WE178.870.R - Cutter 2	86	40	21,2	72

(Complete with back cutter)

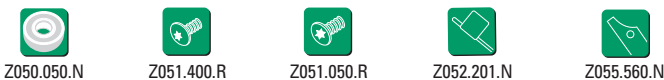

WE178.999.R - Back cutter Ø=54x26,7



HW INSERT PROFILE RAISED PANEL ROUTER CUTTERS Z=2

ART. WE178

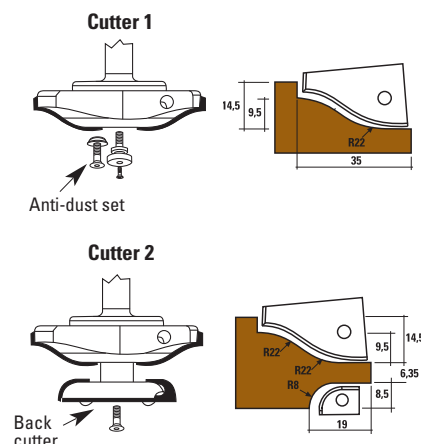
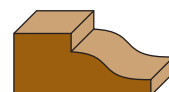
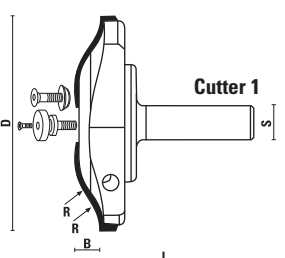

S=1/2" on request art. WG

S Ø 12	D	R	B	L
WE178.862.R - Cutter 1	86	22	19	69
WE178.872.R - Cutter 2	86	22	19	69

(Complete with back cutter)

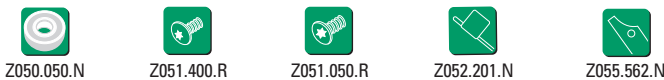

WE178.999.R - Back cutter Ø=54x26,7



HW INSERT PROFILE RAISED PANEL ROUTER CUTTERS Z=2

ART. WE178

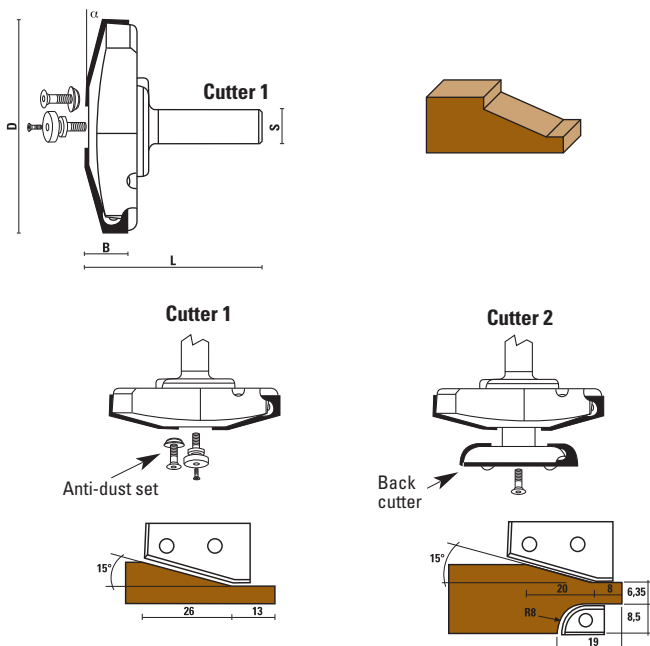

S=1/2" on request art. WG

S Ø 12	D	α	B	L
WE178.861.R - Cutter 1	86	15°	20	71
WE178.871.R - Cutter 2 (Complete with back cutter)	86	15°	20	71

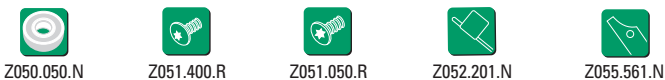

WE178.999.R - Back cutter Ø=54x26,7



HW INSERT FINGER JOINT ROUTER CUTTERS Z=2

ART. WE180

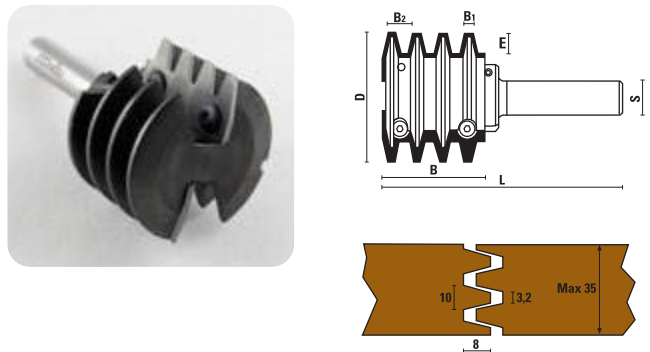

S Ø 12	D	B	B1	B2	E	L
WE180.500.R	50	40	3,2	10	8	93



HW INSERT COUNTER-PROFILE CUTTERS Z=2

ART. WE194 - W195 - WE197 - WE198

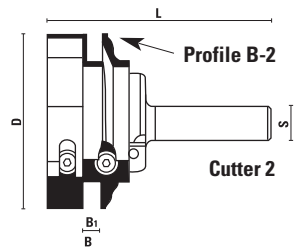
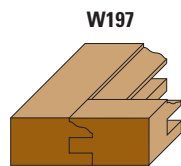
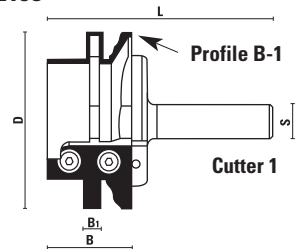

S=1/2" on request art. WG

S Ø 12	D	B	B1	L
WE194.620.R - Cutter 1	62	30	6,35	75
WE194.621.R - Cutter 2	62	30	6,35	75

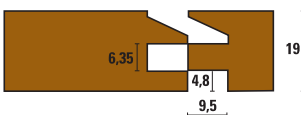

S Ø 12	D	B	B1	L
WE195.620.R - Cutter 1	62	30	6,35	75
WE195.621.R - Cutter 2	62	30	6,35	75

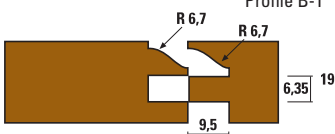

S Ø 12	D	B	B1	L
WE197.620.R - Cutter 1	62	30	6,35	75
WE197.621.R - Cutter 2	62	30	6,35	75

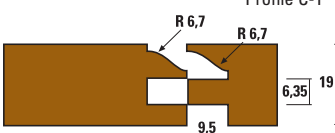

S Ø 12	D	B	B1	L
WE198.620.R - Cutter 1	62	30	6,35	75
WE198.621.R - Cutter 2	62	30	6,35	75

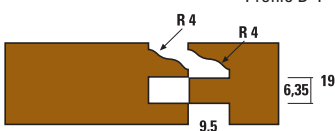

**HW INTERCHANGEABLE INSERT ROUTER BITS
"NOVA SYSTEM" Z=2**

ART. W200 - W201

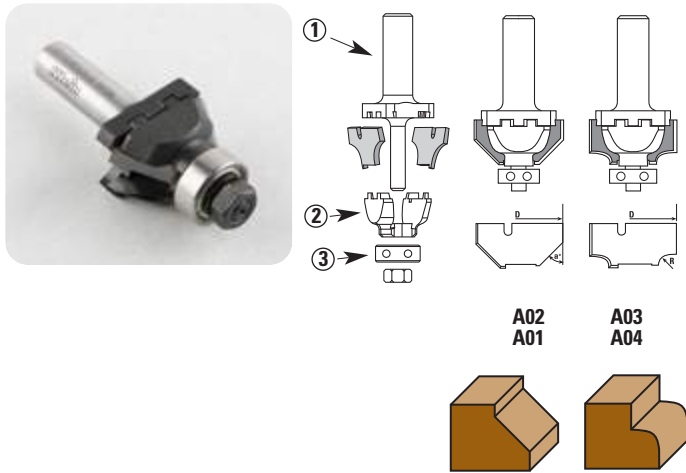

- Replaceable carbide tips
- Patent pending # 129720
- These tools have been checked by the BIA



S Ø 8	S Ø 12	D	α	R
W200.350.C	W200.350.E	35	30°	
W200.A01 - Spare inserts		Pair		
W200.380.C	W200.380.E	38	45°	
W200.A02 - Spare inserts		Pair		
W201.350.C	W201.350.E	35		3,2
W201.A03 - Spare inserts		Pair		
W201.351.C	W201.351.E	35		4,8
W201.A04 - Spare inserts		Pair		

SPARE PARTS

1) Arbor

W200.000.C W200.000.E

2) Safety shield

W201.001.N

3) Ball bearing

Z050.005.N - Ø19/Ø6,4 x 7,1 mm

**HW INTERCHANGEABLE INSERT ROUTER BITS
"NOVA SYSTEM" Z=2**

ART. W202 - W203 - W204 - W205

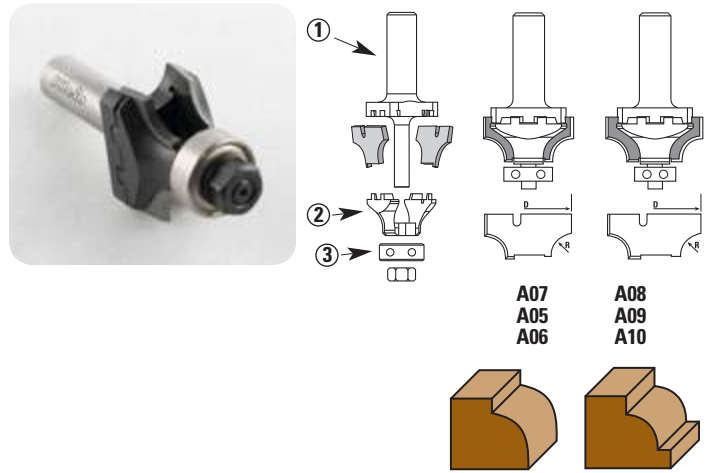

- Replaceable carbide tips
- Patent pending # 129720
- These tools have been checked by the BIA



S Ø 8	S Ø 12	D	R
W202.350.C	W202.350.E	35	6,4
W202.A05 - Spare inserts		Pair	
W202.351.C	W202.351.E	35	8
W202.A06 - Spare inserts		Pair	
W203.380.C	W203.380.E	38	9,5
W203.A07 - Spare inserts		Pair	
W204.350.C	W204.350.E	35	4,8
W204.A08 - Spare inserts		Pair	
W204.351.C	W204.351.E	35	6,4
W204.A09 - Spare inserts		Pair	
W205.380.C	W205.380.E	38	8
W205.A10 - Spare inserts		Pair	

SPARE PARTS

1) Arbor

W200.000.C W200.000.E

2) Safety shield

W201.002.N

3) Ball bearing

Z050.005.N - Ø19/Ø6,4 x 7,1 mm

HW INTERCHANGEABLE INSERT ROUTER BITS "NOVA SYSTEM" Z=2

ART. W206 - W207 - W208

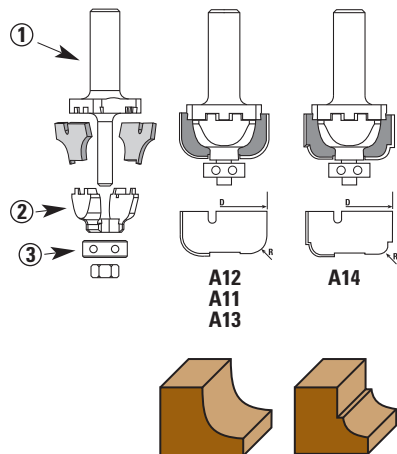

- Replaceable carbide tips
- Patent pending # 129720
- These tools have been checked by the BIA



S Ø 8	S Ø 12	D	R
W206.350.C	W206.350.E	35	6,4
W206.A11 - Spare inserts		Pair	
W206.351.C	W206.351.E	35	8
W206.A12 - Spare inserts		Pair	
W207.380.C	W207.380.E	38	9,5
W207.A13 - Spare inserts		Pair	
W208.350.C	W208.350.E	35	4,8
W208.A14 - Spare inserts		Pair	

SPARE PARTS

1) Arbor

W200.000.C W200.000.E

2) Safety shield

W201.001.N

3) Ball bearing

Z050.005.N - Ø19/Ø6,4 x 7,1 mm

HW INTERCHANGEABLE INSERT ROUTER BITS "NOVA SYSTEM" Z=2

ART. W209 - W210

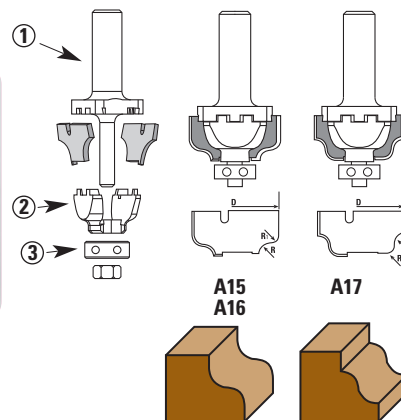

- Replaceable carbide tips
- Patent pending # 129720
- These tools have been checked by the BIA



S Ø 8	S Ø 12	D	R	R1
W209.360.C	W209.360.E	36	4,0	4,5
W209.A15 - Spare inserts		Pair		
W209.380.C	W209.380.E	38	4,0	4,5
W209.A16 - Spare inserts		Pair		
W210.350.C	W210.350.E	35	4,0/4,0	
W210.A17 - Spare inserts		Pair		

SPARE PARTS

1) Arbor

W200.000.C W200.000.E

2) Safety shield

W201.001.N

3) Ball bearing

Z050.005.N - Ø19/Ø6,4 x 7,1 mm

HW INTERCHANGEABLE INSERT ROUTER BITS "NOVA SYSTEM" Z=2

ART. W211 - W212 - W213

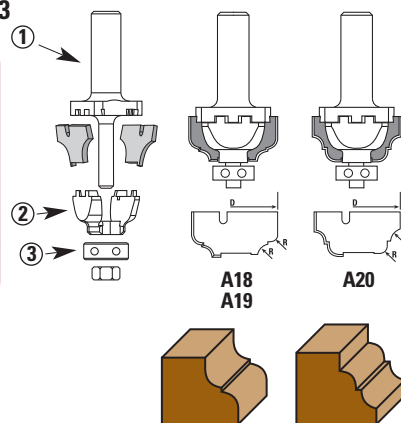

- Replaceable carbide tips
- Patent pending # 129720
- These tools have been checked by the BIA



S Ø 8	S Ø 12	D	R
W211.350.C	W211.350.E	35	4,0/4,0
W211.A18 - Spare inserts		Pair	
W212.380.C	W212.380.E	38	4,0/4,0
W212.A19 - Spare inserts		Pair	
W213.380.C	W213.380.E	38	4,0/4,0
W213.A20 - Spare inserts		Pair	

SPARE PARTS

1) Arbor

W200.000.C W200.000.E

2) Safety shield

W201.001.N

3) Ball bearing

Z050.005.N - Ø19/Ø6,4 x 7,1 mm

HW INTERCHANGEABLE INSERT ROUTER BITS "NOVA SYSTEM" Z=2

ART. W214 - W215 - W216

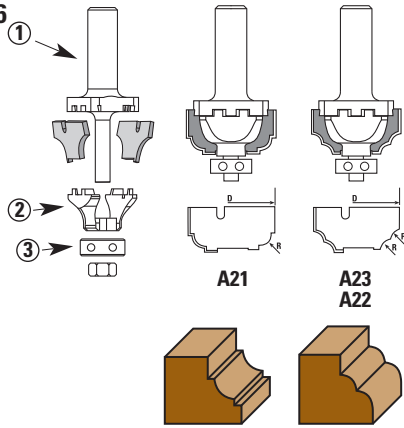

- Replaceable carbide tips
- Patent pending # 129720
- These tools have been checked by the BIA



S Ø 8	S Ø 12	D	R
W214.350.C	W214.350.E	35	4,8
W214.A21 - Spare inserts		Pair	
W215.350.C	W215.350.E	35	4,0/4,0
W215.A22 - Spare inserts		Pair	
W216.380.C	W216.380.E	38	4,0/4,0
W216.A23 - Spare inserts		Pair	

SPARE PARTS

1) Arbor

W200.000.C W200.000.E

2) Safety shield

W201.001.N

3) Ball bearing

Z050.005.N - Ø19/Ø6,4 x 7,1 mm

HW INTERCHANGEABLE INSERT ROUTER BITS "NOVA SYSTEM" Z=2

ART. W250 - W251

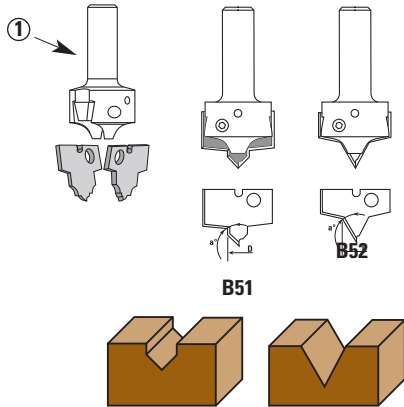

- Replaceable carbide tips
- Patent pending # 129720
- These tools have been checked by the BIA



S Ø 8	S Ø 12	D	α
W250.095.C	W250.095.E	9,5	45°
W250.B51 - Spare inserts		Pair	
W251.127.C	W251.127.E	12,7	30°
W251.B52 - Spare inserts		Pair	

SPARE PARTS

1) Safety shield

W250.000.C W250.000.E

HW INTERCHANGEABLE INSERT ROUTER BITS "NOVA SYSTEM" Z=2

ART. W252 - W253

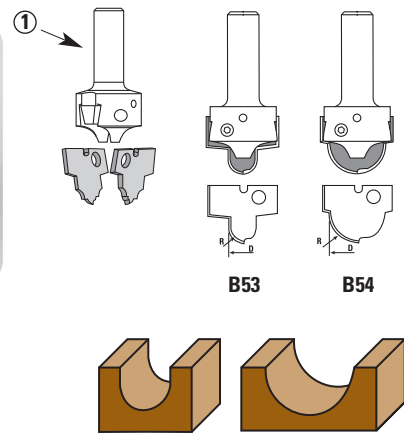

- Replaceable carbide tips
- Patent pending # 129720
- These tools have been checked by the BIA



S Ø 8	S Ø 12	D	R
W252.127.C	W252.127.E	12,7	6,4
W252.B53 - Spare inserts		Pair	
W253.254.C	W253.254.E	25,4	12,7
W253.B54 - Spare inserts		Pair	

SPARE PARTS

1) Safety shield

W250.000.C W250.000.E

HW INTERCHANGEABLE INSERT ROUTER BITS "NOVA SYSTEM" Z=2

ART. W254

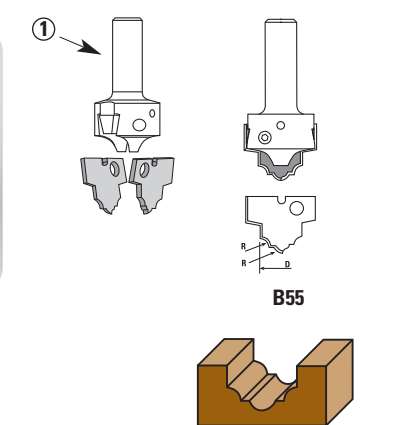

- Replaceable carbide tips
- Patent pending # 129720
- These tools have been checked by the BIA



S Ø 8	S Ø 12	D	R
W254.190.C	W254.190.E	19	4,0/4,0
W254.B55 - Spare inserts		Pair	

SPARE PARTS

1) Safety shield

W250.000.C W250.000.E

HW INSERT ROUTER BITS "NOVA SYSTEM" Z=2

ART. W261 - W262

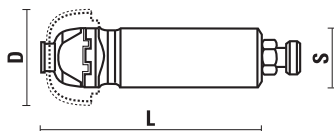

- Patented system
- HW standard knives
- Used on CNC router machines
- Additional knife profiles available on request

Item	D	L	S
W261.000.R only tool body	35÷38	92,5	20
W262.000.R only tool body	35÷38	92,5	25

Add the requested knives

W200.A01	W206.A12
W200.A02	W208.A14
W201.A03	W209.A15
W201.A04	W209.A16
W202.A05	W210.A17
W202.A06	W211.A18
W203.A07	W212.A19
W204.A08	W213.A20
W204.A09	W214.A21
W205.A10	W215.A22
W206.A11	W216.A23

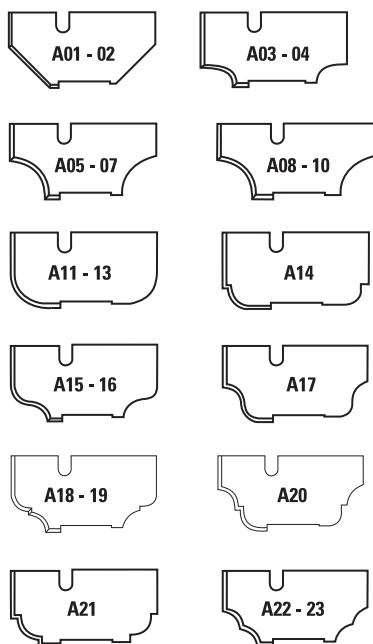

HW INSERT ROUTER BITS "NOVA SYSTEM" Z=2

ART. W260

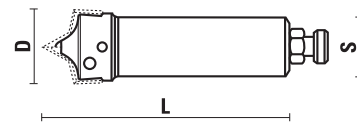

- Patented system
- HW standard knives
- Used on CNC router machines
- Additional knife profiles available on request

Item	D	L	S
W260.000.R only tool body	29,5	82,5	20

Add the requested knives

W250.B51
W251.B52
W252.B53
W253.B54
W254.B55

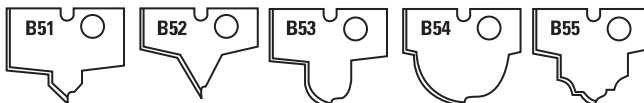

HW INSERT ROUTER BITS "NOVA SYSTEM" Z=2

ART. W263 - W264

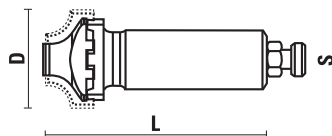

- Patented system
- HW standard knives
- Used on CNC router machines
- Additional knife profiles available on request

Item	D	L	S
W263.000.R only tool body	35÷38	92,5	20
W264.000.R only tool body	35÷38	92,5	25

Add the requested knives

W202.A05
W202.A06
W203.A07
W204.A08
W204.A09
W205.A10



On the tool bodies W260 - W261 - W262 - W263 - W264 special profile knives on customer's drawing can fit

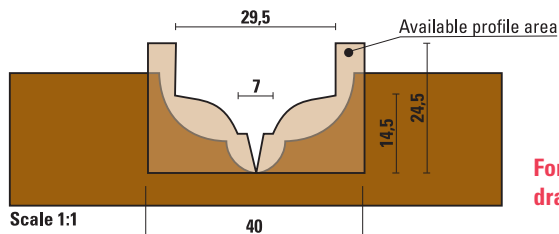
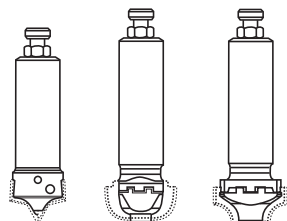

For special knives please provide drawing and quantity requested.

DP ROUTER BITS

ART. X500 - X501 - X502 - X503

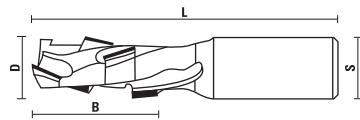

- 2/3 times regrindable
- HW plunging tip
- Recommended for grooving and routing solid hard wood, veneered and laminated MDF
- Used on CNC router machines

RH rotation	LH rotation	D	B	L	S	Z
X500.120.R		12	25	75	12x35	3+1
X500.121.R		12	34	85	12x35	4+1
X501.160.R		16	25	85	16x45	3+1
X501.161.R	X501.161.L	16	34	94	16x45	4+1
X501.180.R		18	25	85	16x45	3+1
X501.181.R	X501.181.L	18	34	94	16x45	4+1
X501.182.R		18	43	103	16x45	5+1
X502.180.R	X502.180.L	18	25	85	20x50	3+1
X502.181.R	X502.181.L	18	34	95	20x50	4+1
X502.182.R	X502.182.L	18	43	103	20x50	5+1
X502.200.R	X502.200.L	20	25	85	20x50	3+1
X502.201.R	X502.201.L	20	34	94	20x50	4+1
X502.202.R	X502.202.L	20	43	103	20x50	5+1
X502.203.R	X502.203.L	20	53	112	20x50	6+1
X503.160.R		16	25	85	25x55	3+1
X503.180.R		18	25	85	25x55	3+1
X503.181.R	X503.181.L	18	34	94	25x55	4+1
X503.182.R	X503.182.L	18	43	103	25x55	5+1
X503.203.R	X503.203.L	20	52	112	25x55	6+1

DP ROUTER BITS

ART. X505 - X506

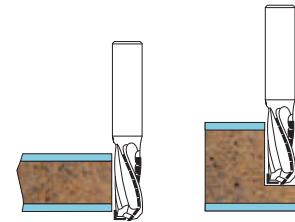
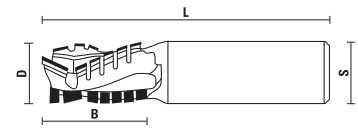

- DP plunging tip
- Recommended for grooving and routing veneered and double-sided laminated boards, also MDF
- Excellent finish on both sides of the workpiece thanks to the alternate shear angle
- Higher feed rate (max. 20.000 m/min)
- Used on CNC router machines

Item	D	B	L	S	Z	Nr. denti
X505.200.R	20	30	88	20x50	3+3	11
X505.201.R	20	35	95	20x50	3+3	13
X505.202.R	20	42	102	20x50	3+3	16
X505.250.R	25	30	88	20x50	3+3	11
X505.251.R	25	35	95	20x50	3+3	13
X505.252.R	25	45	102	20x50	3+3	17
X505.253.R	25	50	110	20x50	3+3	19
X506.200.R	20	30	88	25x50	3+3	11
X506.201.R	20	35	95	25x50	3+3	13
X506.202.R	20	42	102	25x50	3+3	16
X506.250.R	25	30	88	25x50	3+3	11
X506.251.R	25	35	95	25x50	3+3	13
X506.252.R	25	45	102	25x50	3+3	17
X506.253.R	25	50	110	25x50	3+3	19

DP ROUTER BITS

ART. X508 - X509

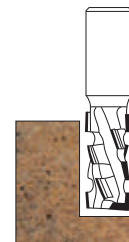
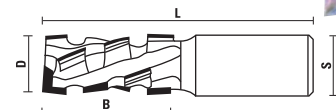

- HW plunging tip
- Used on CNC router machines
- Recommended for grooving and routing solid hard wood, veneered and laminated MDF
- Double number of DP tips compared with items X501÷X503

RH rotation	LH rotation	D	B	L	S	Z
X508.160.R NEW		16	25	85	16x45	6+1
X508.161.R NEW	X508.161.L NEW	16	34	94	16x45	8+1
X508.180.R NEW		18	25	85	16x45	6+1
X508.181.R NEW	X508.181.L NEW	18	34	94	16x45	8+1
X508.182.R NEW		18	43	103	16x45	10+1
X509.180.R NEW	X509.180.L NEW	18	25	85	20x50	6+1
X509.181.R NEW	X509.181.L NEW	18	34	95	20x50	8+1
X509.182.R NEW	X509.182.L NEW	18	43	103	20x50	10+1
X509.200.R NEW	X509.200.L NEW	20	25	85	20x50	6+1
X509.201.R NEW	X509.201.L NEW	20	34	94	20x50	8+1
X509.202.R NEW	X509.202.L NEW	20	43	103	20x50	10+1
X509.203.R NEW	X509.203.L NEW	20	53	112	20x50	12+1

DP ROUTER BITS Z=1

ART. X510

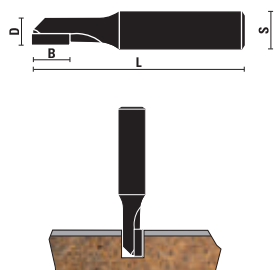

- Right hand rotation
- Solid carbide tool body
- **2/3 times regrindable**
- For cutting and boring on panels of composite materials with lacquered or veneered surfaces

Item	D	B	L	S
X510.040.R	4	10	60	12x35
X510.050.R	5	10	60	12x35
X510.060.R	6	10	60	12x35
X510.080.R	8	15	60	12x35
X510.100.R	10	15	60	12x35

DP ROUTER BITS Z=2

ART. X512

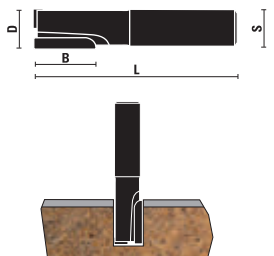

- Right hand rotation
- Solid carbide tool body (only Ø8 - Ø10 - Ø12)
- **2/3 times regrindable**
- For cutting and boring on panels of composite materials with lacquered or veneered surfaces

Item	D	B	L	S
X512.080.R	8	15	60	12x35
X512.100.R	10	15	60	12x35
X512.120.R	12	25	70	12x35
X512.160.R	16	35	80	16x40

DP DOWEL DRILLS

ART. X530 - X531

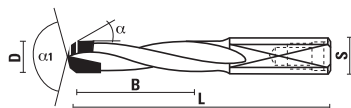

- Shank with flat and screw
- Suitable for drilling very abrasive materials
- Used on CNC router machines

RH rotation	LH rotation	D	B	L	S	Z
X530.050.R	X530.050.L	5	27	57,5	10x26	2
X530.060.R	X530.060.L	6	27	57,5	10x26	2
X530.080.R	X530.080.L	8	27	57,5	10x26	2
X531.050.R	X531.050.L	5	35	70	10x30	2
X531.080.R	X531.080.L	8	35	70	10x30	2

DP THROUGH-HOLE DRILL BITS

ART. X532 - X533

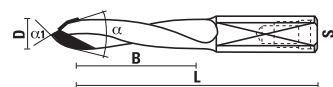

- Shank with flat and screw
- Suitable for drilling very abrasive materials
- Used on CNC router machines

RH rotation	LH rotation	D	B	L	S	Z
X532.050.R	X532.050.L	5	27	57,5	10x26	1
X533.050.R	X533.050.L	5	35	70	10x26	1
X533.060.R	X533.060.L	6	35	70	10x26	2
X533.080.R	X533.080.L	8	35	70	10x26	2

DP HINGE BORING BITS

ART. X540 - X541

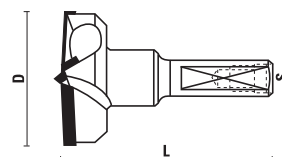

- Shank with flat and screw
- **HW centerpoint**
- Suitable for drilling very abrasive materials
- Used on CNC router machines

RH rotation	LH rotation	D	L	S	Z
X540.150.R	X540.150.L	15	56	10x26	2+2
X540.160.R	X540.160.L	16	56	10x26	2+2
X540.180.R	X540.180.L	18	56	10x26	2+2
X540.200.R	X540.200.L	20	56	10x26	2+2
X540.250.R	X540.250.L	25	56	10x26	2+2
X540.260.R	X540.260.L	26	56	10x26	2+2
X540.300.R	X540.300.L	30	56	10x26	2+2
X540.350.R	X540.350.L	35	56	10x26	2+2
X540.400.R	X540.400.L	40	56	10x26	2+2

X541.150.R	X541.150.L	15	70	10x26	2+2
X541.200.R	X541.200.L	20	70	10x26	2+2
X541.250.R	X541.250.L	25	70	10x26	2+2
X541.350.R	X541.350.L	35	70	10x26	2+2

DP SAWBLADES

ART. XFC

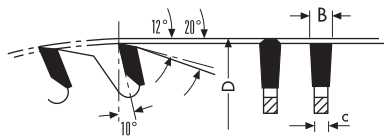

- (FZ/TR) DP triple chip teeth
- For cutting along and across grain of **softwoods, hardwood and exotic timber, double-side veneer laminate boards, MDF and plywood**
- Tooth height H= 4 mm

Pin holes: PH02= 2/7/42 + 2/9,5/46,5 + 2/10/60

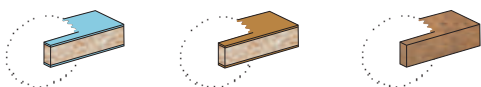

Item	D	d	B/c	Z	Pin holes
XFC250.04830 NEW	250	30	3,2/2,2	48	PH02
XFC250.06030 NEW	250	30	3,2/2,2	60	PH02
XFC300.06030 NEW	300	30	3,2/2,2	60	PH02
XFC300.07230 NEW	300	30	3,2/2,2	72	PH02
XFC350.07230 NEW	350	30	3,5/2,5	72	PH02
XFC350.08430 NEW	350	30	3,5/2,5	84	PH02
XFC350.09630 NEW	350	30	3,5/2,5	96	PH02

DP CONICAL SCORING SAWBLADES

ART. XFI

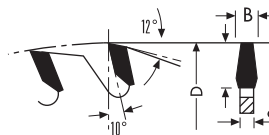

- (KON/FZ) DP conical teeth
- For cutting along and across grain of **softwoods, hardwood and exotic timber, double-side veneer laminate boards, MDF and plywood**
- Tooth height H= 2,5 mm

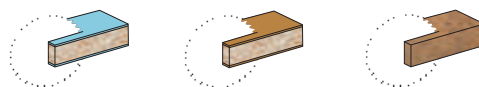

Item	D	d	B/c	Z	Pin holes
XFI120.02020 NEW	120	20	3,1-3,7/2,2	20	
XFI120.02022 NEW	120	22	3,1-3,7/2,2	20	
XFI125.01020 NEW	125	20	2,8-3,4/2,2	10+10	
XFI125.01022 NEW	125	22	2,8-3,4/2,2	10+10	
XFI125.02420 NEW	125	20	3,1-3,7/2,2	20	
XFI125.02422 NEW	125	22	3,1-3,7/2,2	20	
XFI160.03645 NEW	160	45	4,4-5,0/3,2	36	Giben
XFI160.03655 NEW	160	55	4,4-5,0/3,2	36	Gabbiani
XFI180.03620 NEW	180	20	4,4-5,0/3,2	36	
XFI180.03645 NEW	180	45	4,4-5,0/3,2	36	Holzma
XFI180.04450 NEW	180	50	4,4-5,0/3,2	44	Giben
XFI181.03645 NEW	180	45	4,8-5,6/3,5	36	Holzma
XFI182.03620 NEW	180	20	5,8-6,6/4,0	36	Anthon
XFI200.03620 NEW	200	20	4,4-5,0/3,2	36	
XFI200.03630 NEW	200	30	4,4-5,0/3,2	36	
XFI200.03645 NEW	200	45	4,4-5,0/3,2	36	Holzma
XFI200.03665 NEW	200	65	4,4-5,0/3,2	36	Selco
XFI201.03645 NEW	200	45	4,8-5,6/3,5	36	Holzma
XFI201.03665 NEW	200	65	4,8-5,6/3,5	36	Selco
XFI202.03620 NEW	200	20	5,0-5,8/3,5	36	Schelling
XFI203.03645 NEW	200	45	5,8-6,6/4,0	36	Holzma
XFI215.04250 NEW	215	50	4,4-5,0/3,2	42	Giben

DP PANEL SIZING SAWBLADES

ART. XHC

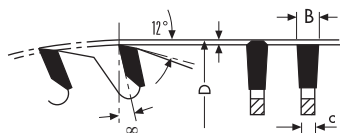

- (FZ/TR) DP triple chip teeth
- For cutting along and across grain of **softwoods, hardwood and exotic timber, double-side veneer laminate boards, MDF and plywood**
- Tooth height **H= 4 mm** (can be produced also with H= 5/6 mm)

Pin holes:

PH01= 2/7/42 + 2/9,5/46,5 + 2/10/60

PH04= 2/14/110 + 2/7/110 + 4/9/100 + 4/19/120 + 2/9/130 (Selco-Gabbani-SCM)

PH05= 4/15/105 + 3/7/100 (Giben-Homag-MacMazza)

Item	D	d	B/c	Z	Pin holes
XHC300.06030 NEW	300	30	4,4/3,2	60	PH01
XHC300.06065 NEW	300	65	4,4/3,2	60	Selco
XHC320.06050 NEW	320	50	4,4/3,2	60	Giben
XHC320.06065 NEW	320	65	4,4/3,2	60	Selco
XHC330.06050 NEW	330	50	4,4/3,2	60	Giben
XHC350.07230 NEW	350	30	4,4/3,2	72	PH01
XHC350.07250 NEW	350	50	4,4/3,2	72	Giben
XHC350.07260 NEW	350	60	4,4/3,2	72	Holzma
XHC350.07265 NEW	350	65	4,4/3,2	72	Selco
XHC350.07275 NEW	350	75	4,4/3,2	72	PH05
XHC350.07280 NEW	350	80	4,4/3,2	72	PH04
XHC360.07250 NEW	360	50	4,4/3,2	72	Giben
XHC360.07265 NEW	360	65	4,4/3,2	72	Selco
XHC370.07230 NEW	370	30	4,4/3,2	72	PH01
XHC380.07260 NEW	380	60	4,8/3,5	72	Holzma
XHC400.07230 NEW	400	30	4,4/3,2	72	2/10/60
XHC400.07260 NEW	400	60	4,4/3,2	72	Anthon
XHC400.07275 NEW	400	75	4,4/3,2	72	Giben-Homag
XHC400.07280 NEW	400	80	4,4/3,2	72	PH04
XHC401.07260 NEW	400	60	4,8/3,5	72	Holzma
XHC420.07260 NEW	420	60	4,8/3,5	72	Holzma
XHC430.07275 NEW	430	75	4,8/3,5	72	Giben
XHC430.07280 NEW	430	80	4,8/3,5	72	PH04
XHC450.07230 NEW	450	30	4,8/3,5	72	Schelling
XHC450.07280 NEW	450	80	4,8/3,5	72	PH04
XHC451.07260 NEW	450	60	4,8/3,5	72	Holzma
XHC451.07280 NEW	450	80	4,8/3,5	72	PH04
XHC460.07230 NEW	460	30	4,4/3,2	72	Schelling
XHC470.07275 NEW	470	75	4,4/3,2	72	Giben
XHC480.07230 NEW	480	30	4,4/3,2	72	Schelling
XHC481.07260 NEW	480	60	4,8/3,5	72	Holzma
XHC481.07280 NEW	480	80	4,8/3,5	72	Selco
XHC500.07260 NEW	500	60	4,8/3,5	72	Holzma
XHC520.07260 NEW	520	60	4,8/3,5	60	Holzma

Spareparts

10

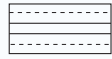

BUSHINGS
Page 10.03

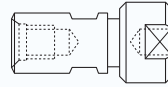

**COLLET CHUCKS WITH
SPRING COLLETS 6 - 8 - 9,5**
Page 10.03



SETTING RINGS
Page 10.03



DRILL HOLDER-SLEEVE
Page 10.03

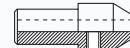

DRILL HOLDERS
Page 10.04



EXTENSION SHAFTS
Page 10.04

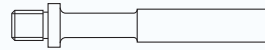

EXTENSION SHAFTS
Page 10.04



**SHAFT ADAPTERS Ø10 FOR
BORING MACHINES**
Page 10.04

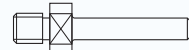

**SHAFT ADAPTERS
FOR PORTABLE ROUTERS**
Page 10.04

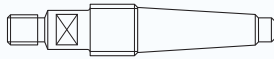

SHAFT ADAPTERS MK2
Page 10.05



ADAPTERS OR EXTENSION SHAFTS
Page 10.05



BALL BEARINGS
Page 10.05



"DELRIN" BALL BEARINGS
Page 10.05



CHEESE HEAD SCREWS
Page 10.06



SLOTTED CHEESE HEAD SCREWS
Page 10.06



COUNTERSUNK HEAD SCREWS
Page 10.06



SET SCREWS
Page 10.06



ROUNDED HEAD SCREWS
Page 10.06

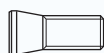

**HEXAGON SOCKET SET SCREWS
FOR WEDGES**
Page 10.07



ALLEN KEYS
Page 10.07



TORX KEYS
Page 10.07

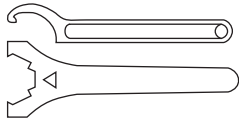

WRENCHES
Page 10.07

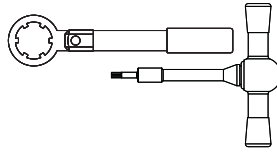

TORQUE WRENCHES
Page 10.08 - 10.09



WASHERS
Page 10.10



SPRING WASHERS
Page 10.10

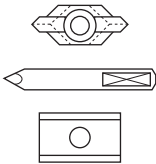

KNIVES
Page 10.10

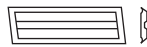

HW "VERSOFIX" KNIVES
Page 10.10



HW KNIVES
Page 10.10



HW KNIVES
Page 10.11



WEDGES
Page 10.12



SPACERS
Page 10.12



LOCK RING
Page 10.12



O-RING
Page 10.12

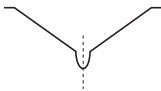

SPRINGS
Page 10.12



THREADED RINGS
Page 10.12

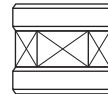

THREADED NUTS FOR MK2 SHANKS
Page 10.13

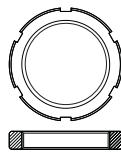

COLLET NUTS
Page 10.13



"NO-NOISE" COLLET NUTS
Page 10.13

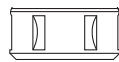

COLLET NUTS
Page 10.13

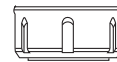

COLLET NUTS WITH BALL BEARINGS
Page 10.13

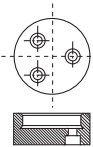

END CAPS
Page 10.14

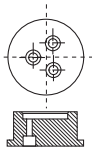

FIXING FLANGE FOR ART. T132.350.NS
Page 10.14



REDUCTION RINGS FOR SAWBLADES
Page 10.14



REDUCTION RINGS FOR CUTTERHEADS
Page 10.15



REDUCING BUSHES
Page 10.15

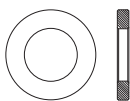

SPACERS AND SPACERS SET
Page 10.16

BUSHINGS

ART. Z001

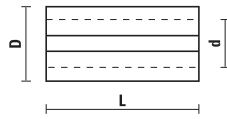

Item	D	d	L
Z001.001.N	8	6	25
Z001.002.N	9,5	6	25
Z001.003.N	9,5	8	25
Z001.004.N	10	8	25
Z001.005.N	12	8	25
Z001.006.N	12	6	25
Z001.007.N	12	10	25
Z001.008.N	16	13	40
Z001.009.N	8	6,4	25
Z001.010.N	12	9,5	25
Z001.011.N	10	6	25
Z001.012.N	8	5	25
Z001.013.N	8	4	25
Z001.014.N	8	3	25
Z001.015.N	10	5	25
Z001.016.N	10	4	25
Z001.017.N	9,5	6,4	25
Z001.018.N	12,7	9,5	25
Z001.019.N	12,7	8	25
Z001.020.N	12,7	6,4	25

COLLET CHUCKS WITH SPRING COLLETS 6 - 8 - 9,5

ART. Z002

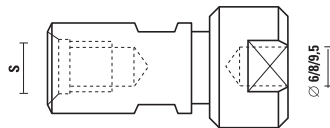

Supplied with nr 3 spring collets Ø6 - Ø8 - Ø9,5

Item	S
Z002.001.R	M12x1 (kit with spring collet)
Z002.002.R	M10x1,5 (kit with spring collet)

Spare parts	
Z002.101.R chuck without collets	M12x1
Z002.102.R chuck without collets	M10x1,5
Z002.160.R	spring collet Ø6
Z002.180.R	spring collet Ø8
Z002.195.R	spring collet Ø9,5

SETTING RINGS

ART. Z003

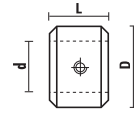

- Rings for setting the drilling depth use when working with manual feed
- Used with Art. R101 - R201 - R 205

Item	d	D	L
Z003.050.N	5	16	10
Z003.060.N	6	16	10
Z003.070.N	7	18	10
Z003.080.N	8	18	10
Z003.090.N	9	20	10
Z003.100.N	10	20	10
Z003.120.N	12	22	10



Z051.301.R



Z052.006.N

DRILL HOLDER-SLEEVE

ART. Z010

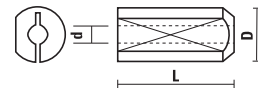

Used with Art. L120



Item	d	D	L
Z010.020.N	2	10	24
Z010.025.N	2,5	10	24
Z010.030.N	3	10	24
Z010.032.N	3,2	10	24
Z010.035.N	3,5	10	24
Z010.040.N	4	10	24
Z010.045.N	4,5	10	24
Z010.050.N	5	10	24
Z010.060.N	6	10	24

DRILL HOLDERS

ART. Z011

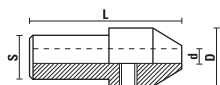

Used with Art. L120



Item	d	D	L	S
Z011.020.N	2	15	35	10x19
Z011.025.N	2,5	15	35	10x19
Z011.030.N	3	15	35	10x19
Z011.032.N	3,2	15	35	10x19
Z011.035.N	3,5	15	35	10x19
Z011.040.N	4	15	35	10x19
Z011.045.N	4,5	15	35	10x19
Z011.050.N	5	15	35	10x19
Z011.060.N	6	15	35	10x19



Z051.311.R



Z052.102.N

EXTENSION SHAFTS

ART. Z021

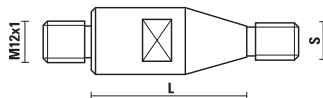
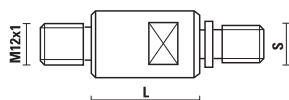

Used with Art. R130

RH rotation	LH rotation	S	L
Z021.025.R	Z021.025.L	M10/11	25
Z021.035.R	Z021.035.L	M10/11	35
Z021.045.R	Z021.045.L	M10/11	45
Z021.125.R	Z021.125.L	M10/30°	25
Z021.135.R	Z021.135.L	M10/30°	35
Z021.145.R	Z021.145.L	M10/30°	45

EXTENSION SHAFTS

ART. Z021

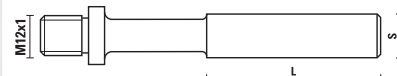

Used with Art. R130 and
Art. F101 - F102 - F104 - F105 - F201 - F203 - F204

RH rotation	LH rotation	S	L
Z021.213.R	Z021.213.L	13	50
Z021.216.R	Z021.216.L	16	50

SHAFT ADAPTERS Ø10 FOR BORING MACHINES

ART. Z021

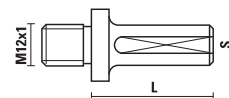

Used with Art. R130

RH rotation	LH rotation	S	L
Z021.310.R	Z021.310.L	10	27
Z021.311.R	Z021.311.L	10	40
Z021.312.R	Z021.312.L	10	47

SHAFT ADAPTERS FOR PORTABLE ROUTERS

ART. Z021

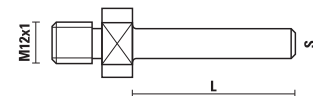

Used with Art. R130
and Art. F101 - F102 - F104 - F105 - F201 - F203 - F204

RH rotation	S	L
Z021.406.R	6	40
Z021.408.R	8	40
Z021.409.R	9,5	40
Z021.410.R	10	40
Z021.412.R	12	40

SHAFT ADAPTERS MK2

ART. Z021

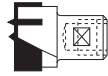
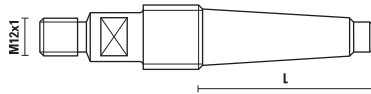

Used with Art. R130

RH rotation	S	L
Z021.500.R	MK2/M20	67

ADAPTERS OR EXTENSION SHAFTS

ART. Z021

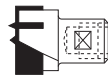
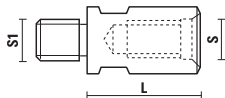

Used with Art. R130
and Art. F101 - F102 - F104 - F105 - F201 - F202 - F203 - F204

RH rotation	S	S1	L
Z021.600.R	M12x1	M12x1	25
Z021.601.R	M12x1	M10x1,5	25
Z021.610.R	M10x1,5	M12x1	25
Z021.611.R	M10x1,5	M10x1,5	25

BALL BEARINGS

ART. Z050

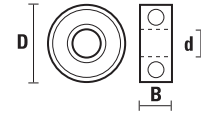

Item	D	d	B
Z050.001.N	9,5	3,2	4
Z050.002.N	9,5	4,8	3,2
Z050.003.N	12,7	4,8	5
Z050.004.N	16	5	5
Z050.005.N	19	6,4	7,1
Z050.006.N	19	6	6
Z050.007.N	12,7	6,4	4,7
Z050.008.N	22	8	7
Z050.009.N	25,4	15	5,5
Z050.010.N	28	8	9
Z050.011.N	15,8	6,4	5
Z050.012.N	19	12,7	4
Z050.013.N	38	15	8,5
Z050.014.N	35	15	11
Z050.015.N	28,6	12,7	8
Z050.016.N	33,5	8	8,6
Z050.017.N	6,4	3,2	2,8
Z050.018.N	16	8	5
Z050.019.N	14	8	4
Z050.022.N	16	4,8	5
Z050.023.N	19	4,8	5
Z050.024.N	19	5	5

"DELRIN®" BALL BEARINGS

ART. Z050

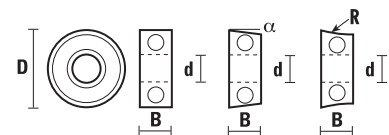

Used for working solid surface (CORIAN®)

Item	D	d	B	α	R
Z050.100.N	12,7	4,8	3,2	0°	
Z050.101.N	19	6,4	5	0°	
Z050.102.N	21,8	6,4	5	10°	
Z050.103.N	22,2	6,4	5	5°	
Z050.104.N	28,6	15	7	0°	
Z050.105.N	19	6,4	6,4		R=12,7
Z050.106.N	25,4	6,4	7	5°	
Z050.107.N	28	8	8,5	0°	
Z050.108.N	29	8	8,5	0°	
Z050.109.N	34	8	8,5	0°	
Z050.110.N	22	6	7	11°	
Z050.111.N	19	6	7	0°	
Z050.112.N	28,6	7,9	7	0°	

CHEESE HEAD SCREWS

ART. Z051

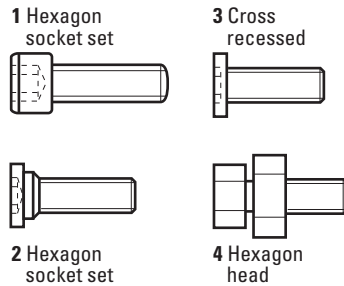

Item	Description	Draw.
Z051.001.R	M 2,5x12 ch 1,9	1
Z051.002.R	M 3,5x13 ch 2,4	1
Z051.004.R	M 5x17 ch 4	1
Z051.006.R	M 2,2x8 for art. A119.064.R	3
Z051.007.R	M 5x13 ch 3 for art. E316	2
Z051.008.R	M 3x12 ch 2,4	1
Z051.012.R	M 5x16 ch 4 for art. R110.600.R	1
Z051.013.R	M 6,3x19 ch 4,7 for art. R110.800.R	1
Z051.016.R	M 6x25 ch 5 for art. T128 cutter arbors	1
Z051.050.R	anti dust set for art. WE178	
Z051.312.R	M 5x10 for NOVASYSTEM	1
Z051.401.R	M 8x10	1
Z051.506.R NEW	M 8x30 hex socket 13 complete with hexagon nut for art. T128.140.R	4

SLOTTED CHEESE HEAD SCREWS

ART. Z051

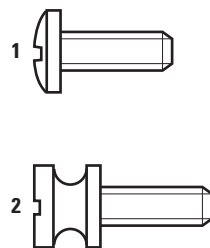

Item	Description	Draw.
Z051.501.R	M 3x4 for spare knife art. WC	1
Z051.503.R	M 3x10 for ball bearing art. WC	1
Z051.505.R	M 5x17 for machines Weeke	2

COUNTERSUNK HEAD SCREWS

ART. Z051

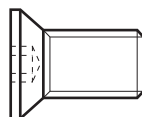

Item	Description
Z051.011.R	M 4x8 Torx T15
Z051.014.R	M 6x10 for art. T128.140.R slotted head
Z051.015.R	M 5x15 ch 3 for art. A/B/C/E/G - 117.280.R
Z051.307.R	M 5x6
Z051.309.R	M 3x6 Torx T9
Z051.310.R	M 3x8 Torx T9
Z051.315.R	M 4x6,5 Torx T9
Z051.403.R	M 5x6 Torx T20
Z051.405.R	M 5x15 ch 2,5
Z051.700.R	M 4x3,2 Torx T15
Z051.701.R	M 5x7 Torx T15

SET SCREWS

ART. Z051

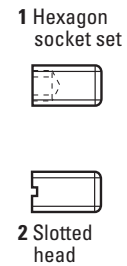

Item	Description	Draw.
Z051.005.R	M 3x2,5 ch 1,6 with flat point	1
Z051.101.R	M 2,5x2,5 ch 1,3 with flat point	1
Z051.102.R	M 4x4 ch 2 with flat point	1
Z051.300.R	M 6x6 ch 3 with flat point for L130 D=Ø8÷12	1
Z051.301.R	M 5x5 ch 2,5 with flat point	1
Z051.302.R	M 5x10	2
Z051.303.R	M 5x6 ch 2,5 with cone point for art. L130 D=Ø4÷8	1
Z051.304.R	M 6x6 ch 3 with flat point for art. L131 D=Ø12	1
Z051.306.R	M 5x6 ch 2,5 with cone point	1
Z051.311.R	M 4x5 ch 2 with flat point for art. Z011	1
Z051.313.R	M 5x4 ch 2,5 with flat point	1
Z051.314.R	M 6x5 ch 3 with flat point for art. L131 D=Ø10	1
Z051.321.R	M 3x5 ch 1,6	1
Z051.404.R	M 3x6 ch 1,5 with cone point for art. W182	1
Z051.407.R	M 6x10 ch 3	1
Z051.704.R	M 8x12 ch 4 with cyl point for art. SA	1
Z051.705.R	M 8x16 ch 4 with cyl point for art. SA	1

ROUNDED HEAD SCREWS

ART. Z051

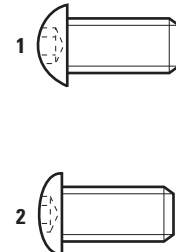

Item	Description	Draw.
Z051.010.R	M 4x8 - Ø9 - T15	1
Z051.201.R	M 4x9 - Ø7,8 - T15	1
Z051.210.R	M 3,5x7 - Ø7,8 - T15	2
Z051.211.R	M 3,5x7 - Ø9 - T15	1
Z051.308.R	M 3x6 - T9 - Ø5,5	1
Z051.320.R	M 3x4	1
Z051.400.R	M 4x6 for art. W178 - Ø8	1
Z051.402.R	M 4x8 for art. W171/W176 - Ø9	1
Z051.406.R	M 4x3,2 for art. W182	1
Z051.702.R	M 5x10 for art. TTL	1

HEXAGON SOCKET SET SCREWS FOR WEDGES

ART. Z051

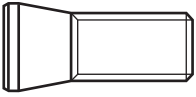

Item	Description	For item
Z051.800.R	M 5x18	TA/TB/TC
Z051.801.R	M 7x21	TB
Z051.802.R	M 8x21	THL
Z051.803.R	M 6x10	TI 120
Z051.804.R	M 6x12	TI 160
Z051.805.R	M 8x20	TLL
Z051.807.R	M 6x20	TYL
Z051.808.R	M 6x25	TWL
Z051.809.R	M 8x18	TZA
Z051.810.R	M 8x16	TEL

ALLEN KEYS

ART. Z052



Item	Description
Z052.001.N	ch 1,9
Z052.002.N	ch 2,4
Z052.003.N	ch 4
Z052.005.N	ch 1,6
Z052.006.N	ch 2,5 for art. L001.100L/R
Z052.007.N	ch 1,5
Z052.013.N	ch 4,7 for art. R110.800.R
Z052.101.N	ch 1,3
Z052.102.N	ch 2
Z052.103.N	ch 3 for art. W168
Z052.104.N	ch 4 for art. W168
Z052.406.N	ch 3 for art. SB080

TORX KEYS

ART. Z052



Item	Description
Z052.004.N	Torx T10
Z052.201.N	Torx T15
Z052.302.N	Torx T9

WRENCHES

ART. Z052

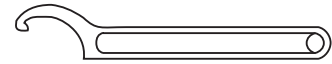

Item	Description
Z052.300.N NEW	Wrench 34/38 for collet nut DIN6388/EOC12
Z052.301.N	Wrench 40/42 for art. Z091.000.R
Z052.310.N	Wrench 58/62 for collet nut DIN6388/EOC25

WRENCHES FOR COLLET NUT "STANDARD"

ART. Z052

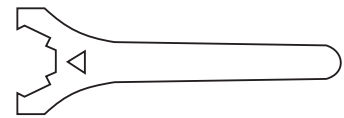

Item	Description
Z052.401.N	Wrench for collet nut ER 32 "standard" type
Z052.402.N	Wrench for collet nut ER 40 "standard" type
Z052.404.N	Wrench for collet nut ER 20 "standard" type
Z052.407.N	Wrench for collet nut ER 25 "standard" type
Z052.409.N	Wrench for collet nut ER 16 "standard" type

WRENCHES FOR COLLET NUT "MINI"

ART. Z052

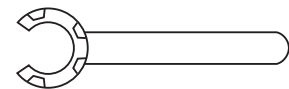

Item	Description
Z052.503.N	Wrench for collet nut ER 25 "mini" type
Z052.505.N	Wrench for collet nut ER 16 "mini" type
Z052.508.N	Wrench for collet nut ER 20 "mini" type
Z052.511.N	Wrench for collet nut ER 11 "mini" type

TORQUE WRENCHES

While setting a tool it is extremely important to tighten it properly.

If not effectively tight indeed a cutting tool could slide away from the tool holder during the working process. On the other side, an excessive tightening can cause damages to the tool holder or spring collet or the tool itself.

The wrench indicates when the torque (Nm) is reached according to the value indicated.

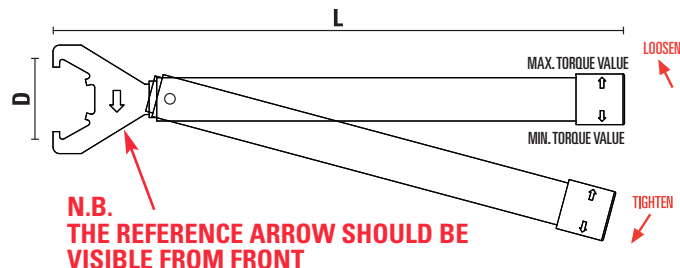

TORQUE WRENCHES FOR "MINI" NUTS

ART. Z052

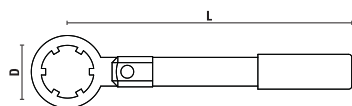

Item	D	L	Nm	Threaded nut
Z052.701.N	16	120	18	ER11
Z052.702.N	22	175	28	ER16
Z052.703.N	28	180	35	ER20
Z052.704.N	35	185	40	ER25

TORQUE WRENCHES FOR "STANDARD" NUTS

ART. Z052

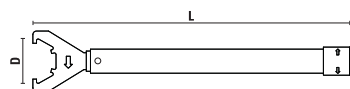

Dis ①  Collets as per drawing n. 1 must be tightened by setting the minimum torque value and rotating the handle counterclockwise.

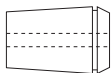
Dis ②  Collets as per drawing n. 2 must be tightened by setting the maximum torque value and rotating the handle clockwise.

Item	D	L	Nm (Dr. 1)	Nm (Dr. 2)	Threaded nut
Z052.710.N	32	380	25-35	45-55	ER16
Z052.711.N	35	380	30-20	60-70	ER20
Z052.712.N	40	400	40-55	80-90	ER25
Z052.713.N	50	400	66-70	120-130	ER32
Z052.714.N	63	450	110-120	190-200	ER40

TORQUE HOOK WRENCHES

ART. Z052

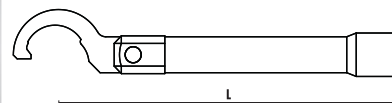

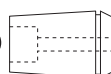
Dis ①  Collets as per drawing n. 1 must be tightened by setting the minimum torque value and rotating the handle counterclockwise.

Dis ②  Collets as per drawing n. 2 must be tightened by setting the maximum torque value and rotating the handle clockwise.

Item	D	L	Nm (Dr. 1)	Nm (Dr. 2)	Threaded nut
Z052.732.N	58-62	380	110-120	190-200	DIN6388

TORQUE WRENCHES FOR "NO-NOISE" NUTS

ART. Z052

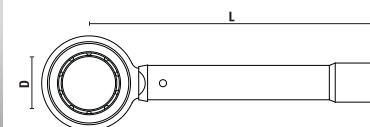

Item	D	L	Nm (dis. 1)	Nm (dis. 2)	Threaded nut
Z052.790.N NEW	32	400	25-35	45-55	ER 16
Z052.793.N NEW	50	400	65-70	120-130	ER 32
Z052.795.N NEW	60	400	110-120	190-200	DIN 6388/EOC25

While tightening with constant action a strong shot is perceived both mechanically and acoustically. This indicates that the set torque is reached.

TORQUE WRENCHES FOR "TORX" SCREWS

ART. Z052

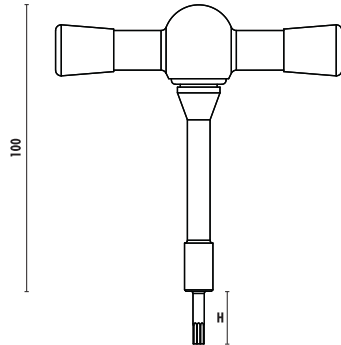

H=50 Spare bits



H=25



Supplied with H=25

Item	Torx	Nm
Z052.748.N	T6	0,6
Z052.749.N	T7	0,9
Z052.750.N	T8	1,2
Z052.751.N	T9	1,4
Z052.752.N	T10	2
Z052.753.N	T15	3
Z052.754.N	T20	5
Z052.755.N	T25	7,2

Spare parts	Torx	H
Z052.748.NCH25	T6	25
Z052.749.NCH25	T7	25
Z052.750.NCH25	T8	25
Z052.750.NCH50	T8	50
Z052.751.NCH25	T9	25
Z052.751.NCH50	T9	50
Z052.752.NCH25	T10	25
Z052.752.NCH50	T10	50
Z052.753.NCH25	T15	25
Z052.753.NCH50	T15	50
Z052.754.NCH25	T20	25
Z052.754.NCH50	T20	50
Z052.755.NCH25	T25	25
Z052.755.NCH50	T25	50

Insert bits in 5 pieces box

TORQUE WRENCHES FOR "HEX" SCREWS

ART. Z052

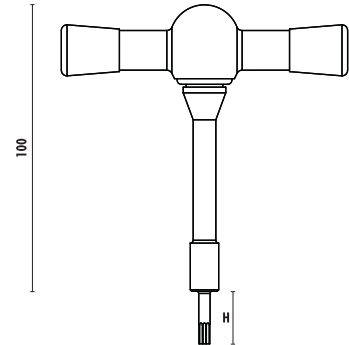

Spare bits

H=25



Supplied with H=25

ITEM	Socket size	Nm	Used on screw
Z052.771.N	1,3	0,10	Z051.101.R
Z052.772.N	1,5	0,12	Z051.404.R
Z052.773.N	2	0,50	Z051.001.R
Z052.774.N	2,4	0,76	Z051.002.R
Z052.775.N	4	3,10	Z051.004.R
Z052.776.N	5	5,00	Z051.016.R
Z052.785.N	1,6	3,00	Z051.005.R
Z052.786.N	2,5	5,00	Z051.301.R
Z052.787.N	3	7,00	Z051.314.R

Spare parts	Socket size
Z052.771.NCH25	1,3
Z052.772.NCH25	1,5
Z052.773.NCH25	2
Z052.774.NCH25	2,4
Z052.775.NCH25	4
Z052.776.NCH25	5
Z052.785.NCH25	1,6
Z052.786.NCH25	2,5
Z052.787.NCH25	3

Insert bits in 5 pieces box

WASHERS

ART. Z053



Item	D	d
Z053.001.N	9,5	3,2
Z053.002.N	8	4,8
Z053.003.N	12,7	4,8
Z053.004.N	16	5
Z053.010.N	9,5	6,4

SPRING WASHERS

ART. Z054



Item	D	d
Z054.001.N	6	2,5
Z054.002.N	7,5	3,2
Z054.003.N	11	6,4
Z054.410.N	9,5	6,4

KNIVES

ART. Z055

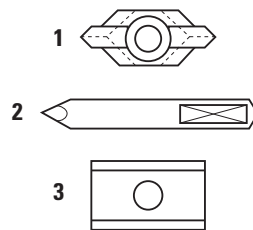

Item	Drawing	
Z055.100.N	1	spur
Z055.101.N	2	centerpoint
Z055.125.N	3	HW-knife for Ø25
Z055.126.N	3	HW-knife for Ø26
Z055.130.N	3	HW-knife for Ø30
Z055.135.N	3	HW-knife for Ø35
Z055.140.N	3	HW-knife for Ø40

HW "VERSOFIX" KNIVES

ART. Z055

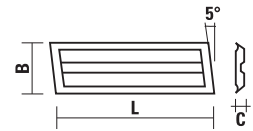

- HW-knife "Kawedur"
- 4 cutting edges
- Spare parts for Art. W120÷W127

Item	L	B	C
Z055.220.N	20	5,5	1,1
Z055.221.N	20	10	1,5
Z055.230.N	30	6,5	1,1
Z055.231.N	30	10	1,5
Z055.250.N	50	10	1,5

HW KNIVES

ART. Z055

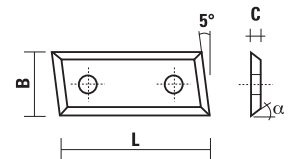

- 4 cutting edges
- Spare parts for Art. W153 - W154 - W155 - W156

Item	L	B	C
Z055.423.N	30	9	1,5
Z055.424.N	40	9	1,5
Z055.425.N	50	9	1,5
Z055.430.N	30	12	1,5
Z055.440.N	40	12	1,5
Z055.450.N	50	12	1,5

HW KNIVES

ART. Z055

Item	Description	For item
Z055.300.N	29,5x9x1,5	WC101
Z055.500.R	50x5,5x1,1	W174 - W175
Z055.500.L	50x5,5x1,1 Sx	W174 - W175
Z055.501.N	16x7x1,5 (1 chip breaker)	W172 - W173
Z055.502.N	16x7x1,5 (2 chip breaker)	W172 - W173
Z055.503.N	23x7x1,5 (1 chip breaker)	W172 - W173
Z055.504.N	23x7x1,5 (2 chip breaker)	W172 - W173
Z055.505.N	48x12x1,5	W171.670.R
Z055.506.N	27x9x1,5	W170.210.R+260
Z055.507.N	28x12x1,5	W170.380.R
Z055.516.N	16x7x1,5	W165
Z055.528.N	28x7x1,5	W165
Z055.529.N	29,5x5,5x1,1	WE101.120.R
Z055.520.N	R= 3	WE152.250.R
Z055.521.N	R= 6	WE152.280.R
Z055.522.N	R= 8	WE152.320.R
Z055.523.N	R= 10	WE152.360.R
Z055.550.N	R= 6	WC111
Z055.551.N	20x9x1,5	WC120
Z055.552.N	13,25x9x1,1	WC121
Z055.553.N	R= 3/45°	WC122
Z055.554.N	R= 6	WC123
Z055.555.N	R= 6	WC125
Z055.556.N	R= 4,5	WC129
Z055.560.N	33,3x18,5x2	W178.860.R
Z055.561.N	31x17x2	W178.861.R
Z055.562.N	32x20x1,5	W178.862.R
Z055.569.N	13,9x9,5x2 - R=8	W178.999.R
Z055.571.N	40x19x2	WE180
Z055.572.N	R= 6,4	WE112
Z055.573.N	R= 8	WE112
Z055.574.N	R= 9,5	WE112
Z055.575.N	R= 12,7	WE112
Z055.580.N	30x23x2	WE194
Z055.581.N	30x23x2	WE194
Z055.582.N	30x23x2	WE195
Z055.583.N	30x23x2	WE195
Z055.584.N	30x23x2	WE197
Z055.585.N	30x23x2	WE197
Z055.586.N	30x23x2	WE198
Z055.587.N	30x23x2	WE198
Z055.628.N	40x28x1,5	WE180 - W181
Z055.641.N	Profile C1 - 45°	W162
Z055.642.N	Profile C2 - R= 4/45°	W162
Z055.643.N	Profile C3 - R= 1/11	W162
Z055.644.N	Profile C4 - R= 3°	W162
Z055.645.N	Profile C5 - R= 8/30°	W162
Z055.646.N	Profile C6 - R= 4/2	W162
Z055.647.N	Profile C7 - R= 12	W162
Z055.648.N	Profile C8 - R= 3/2	W162
Z055.649.N	Profile C9 - R= 2/10	W162
Z055.650.N	Profile C10 - R= 45°/2	W162
Z055.651.N	Profile B1 - R= 12x4	W161
Z055.652.N	Profile B2 - R= 12	W161
Z055.653.N	Profile B3 - R= 15	W161
Z055.654.N	Profile B4 - R= 3/R3	W161
Z055.655.N	Profile B5 - R= 26/5	W161
Z055.656.N	Profile B6 - R= 6/1,5	W161

Item	Item	Description	For item
Z055.661.N		Profile A1 - R= 10/4	W160
Z055.662.N		Profile A2 - R= 6/6	W160
Z055.663.N		Profile A3 - R= 5/6	W160
Z055.664.N		Profile A4 - R= 15/14	W160
Z055.665.N		Profile A5 - R= 3/20°	W160
Z055.666.N		Profile A6 - R= 5/20°	W160
Z055.800.R	Z055.800.L	R= 2/45°	TLL
Z055.801.R	Z055.801.L	R= 3/45°	TLL
Z055.802.R	Z055.802.L	R= 4/45°	TLL
Z055.803.R	Z055.803.L	R= 5/45°	TLL
Z055.804.R	Z055.804.L	R= 6/45°	TLL
Z055.805.R		R= 3/6	TML
Z055.806.R		R= 4/8	TML
Z055.807.R		R= 5/10	TML
Z055.808.R		R= 12/18	TML
Z055.809.R		R= 15/20	TML
Z055.810.R		R= 4/4	TNL
Z055.811.R		R= 6/6	TNL
Z055.812.R		R= 8/8	TNL
Z055.813.R		R= 10/10	TNL
Z055.814.R		R= 12/12	TNL
Z055.815.R		R= 15/15	TNL
Z055.830.R		45°	TSL
Z055.831.N		Profile A	TTL
Z055.832.N		Profile B	TTL
Z055.833.N		Profile C	TTL
Z055.834.N		Profile D	TTL
Z055.835.N		Profile E	TTL
Z055.836.N		Profile F	TTL
Z055.841.R		Profile A	TVL
Z055.842.R		Profile B	TVL
Z055.843.N		Profile A	TWL
Z055.844.N		Profile B	TWL
Z055.845.N		Profile C	TWL
Z055.846.N		Profile D	TWL
Z055.847.N		Profile A4	TZL
Z055.848.N		Profile B4	TZL
Z055.851.R		Profile A1	TYL
Z055.852.R		Profile A2	TYL
Z055.853.R		Profile B1	TYL
Z055.854.R		Profile B2	TYL
Z055.855.R		Profile C1	TYL
Z055.856.R		Profile C2	TYL
Z055.857.R		Profile D1	TYL
Z055.858.R		Profile D2	TYL
Z055.859.R		Profile E1	TYL
Z055.860.R		Profile E2	TYL
Z055.861.N		Profile A1	TS
Z055.862.N		Profile B1	TS
Z055.863.N		Profile A2	TS
Z055.864.N		Profile B2	TS
Z055.870.R	Z055.870.L	R= 3	W184+W185
Z055.871.R	Z055.871.L	R= 4	W184+W185
Z055.872.R	Z055.872.L	R= 5	W184+W185
Z055.873.R	Z055.873.L	R= 6	W184+W185
Z055.874.R	Z055.874.L	R= 8	W184+W185
Z055.875.R	Z055.875.L	R= 10	W184+W185
Z055.876.R	Z055.876.L	45°	W184+W185

WEDGES

ART. Z056



Item	Description	For item
Z056.100.N	40x22,5x4	W180
Z056.101.N	40x13,5x8	W180/W181
Z056.102.N	L= 6,5	W182
Z056.700.N	L= 6,8	TA/TC
Z056.701.N	L= 14	TB
Z056.702.N	L= 46	TEL
Z056.703.N	L= 26	TF
Z056.704.N	45°	THL
Z056.705.N	L= 37	TI
Z056.706.N	L= 47	TI 160
Z056.707.N	wedge	TLL
Z056.708.N	wedge	TLL
Z056.709.N	D= 112/113	TML
Z056.710.N	D= 109/132	TML
Z056.711.N	D= 122	TNL
Z056.712.N	R= 8/9/10	TOL
Z056.719.N	45°	TSL
Z056.721.N	for profile A	TVL
Z056.722.N	for profile B	TVL
Z056.723.N	for profiles A/B/C/D	TWL
Z056.724.N	for profiles A1/B1/C1/D1/E1	TYL
Z056.725.N	for profiles A2/B2/C2/D2/E2	TYL
Z056.726.N	L= 46	TS
Z056.760.N	L= 120	TZA
Z056.761.N	L= 130	TZA
Z056.762.N	L= 150	TZA
Z056.763.N	L= 180	TZA
Z056.764.N	L= 230	TZA
Z056.765.N	L= 38	W168
Z056.790.N	38x24x13	SA
Z056.791.N	38x15x16	SA
Z056.800.N	wedges	TSL/THL

SPACERS

ART. Z057

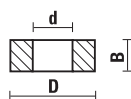

Item	D	d	B
Z057.001.N	16	7,94	3,6
Z057.002.N	16	7,94	1
Z057.003.N	16	7,94	0,5
Z057.004.N	16	7,94	0,1
Z057.005.N	16	7,94	3
Z057.006.N	16	7,94	6
Z057.007.N	16	7,94	0,4
Z057.008.N	16	7,94	0,05
Z057.009.N	16	7,94	5,3
Z057.010.N	9,5	6,4	2,2
Z057.101.N	10	6	1
Z057.102.N	10	6	1,5
Z057.103.N	10	6	3

LOCK RING

ART. Z058

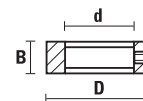

Item	D	d	B
Z058.001.N	11	6,4	5
Z058.002.N	18,2	12,7	6
Z058.003.N	20	12,7	6

O-RING

ART. Z059

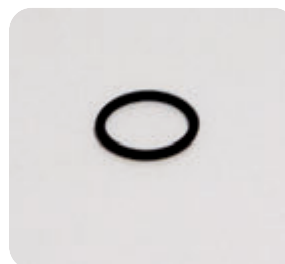

Item	D	Rotation
Z059.001.L	8,5	Left (red color)
Z059.001.R	8,5	Right (black color)

SPRINGS

ART. Z060

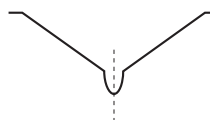

Item	Description	For item
Z060.100.N	36x95	TZA

THREADED RINGS

ART. Z060

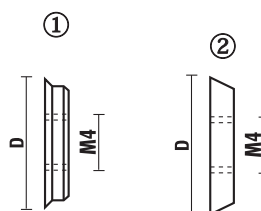

Item	Description	For item	Drawing
Z060.700.R	thread M4/10	TA	1
Z060.701.R	thread M4/12	TA	2
Z060.750.N	thread M4/12	W182	2
Z060.751.N	thread M4/10	W182	1

THREADED NUTS FOR MK2 SHANKS

ART. Z090

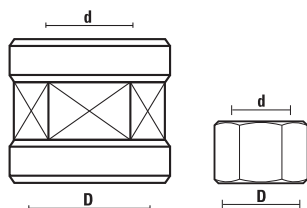

RH rotation	LH rotation	D	d	Wrench
Z090.001.R	Z090.001.L	M33x3	Ø20/14x1"	38
Z090.002.R	Z090.002.L	M33x3	M30x1,5	38
Z090.011.R		1"1/8"x7G8	Ø20/14x1"	38
Z090.012.R	Z090.012.L	1"1/8"x7G9	M30x1,5	38

COLLET NUTS

ART. Z091

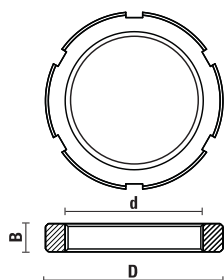

For Art. T118.953.R/T118.956.R/T118.959.R

Item	D	B	d	Rotation
Z091.902.R NEW	63	10	M 50x1,5	RH

"NO-NOISE" COLLET NUTS

ART. Z091

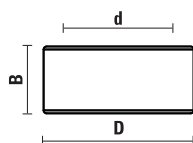

- Recommended when using router bits working at higher RPM
 - Threaded nut with ground contours, remarkable reduction of noise

Item	Tipo	D	B	d	Rot.
Z091.501.R NEW	DIN 6499 (ER 32)	50	23	M 40x1,5	RH
Z091.505.R NEW	DIN 6499 (ER 16)	32	17,5	M 22x1,5	RH
Z091.522.R NEW	DIN 6499 (EOC 25)	60	30	M 48x2	RH

COLLET NUTS

ART. Z091

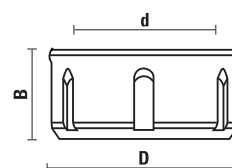

Item		D	B	d	Rotation
Z091.001.R	DIN 6499 (ER 32)	50	23	M 40x1,5	RH
Z091.001.L	DIN 6499 (ER 32)	50	23	M 40x1,5	LH
Z091.002.R	DIN 6499 (ER 40)	63	25	M 50x1,5	RH
Z091.002.L	DIN 6499 (ER 40)	63	25	M 50x1,5	LH
Z091.103.R	DIN 6499 (ER 25)	42	20	M 32x1,5	RH
Z091.104.R	DIN 6499 (ER 20)	35	19	M 25x1,5	RH
Z091.105.R	DIN 6499 (ER 16)	32	17,5	M 22x1,5	RH
Z091.202.R	DIN 6388 (EOC25)	60	30	M 48x2	RH
Z091.205.R NEW	DIN 6388 (EOC12)	35	28	M 27x1,5	RH
Z091.301.R	ETS 32	50	23	M 40x1,5	RH
Z091.302.R	ETS 40	63	25	M 50x1,5	RH
Z091.403.R	ER 25 type mini	35	20	M 30x1	RH
Z091.404.R	ER 20 type mini	28	19	M 24x1	RH
Z091.405.R	ER 16 type mini	22	18	M 19x1	RH
Z091.406.R	ER 11 type mini	16	12	M 13x0,75	RH

COLLET NUTS WITH BALL BEARINGS

ART. Z091

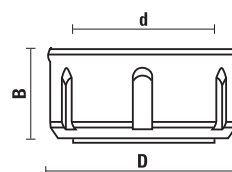

Item		D	B	d	Rotation
Z091.100.R NEW	DIN 6499 (ER 25)	42	20	M 32x1,5	RH
Z091.101.R	DIN 6499 (ER 32)	50	26	M 40x1,5	RH
Z091.102.R	DIN 6499 (ER 40)	63	29	M 50x1,5	RH
Z091.203.R	DIN 6388 (EOC25)	60	30	M 48x2	RH

END CAPS

ART. Z092

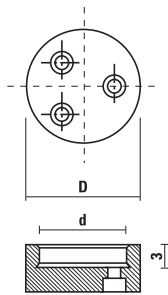

Hollow end cap (FF)

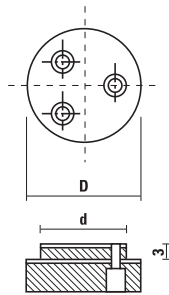

Extended end cap (FP)

Use on arbors Art. T128

Item	d	D	Type
Z092.001.R	30	40	FF
Z092.002.R	30	40	FP
Z092.003.R NEW	35	50	FF
Z092.004.R NEW	35	50	FP
Z092.005.R NEW	40	50	FF
Z092.006.R NEW	40	50	FP
Z092.007.R NEW	25,4 (1")	50	FF
Z092.008.R NEW	25,4 (1")	50	FP
Z092.009.R NEW	31,75 (1/4")	50	FF
Z092.010.R NEW	31,75 (1/4")	50	FP

FIXING FLANGE FOR ART. T132.350.NS

ART. Z092

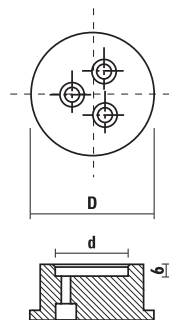

Hollow end cap (FF)

Use on arbors Art. T132.350.NS

Item	d	D	Type
Z092.050.R NEW	40	80	FF

REDUCTION RINGS FOR SAWBLADES

ART. ZA

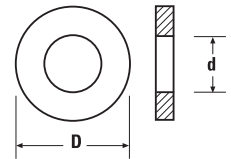

Item	D	d
ZA000.02012	20	12,7
ZA000.02014 Selling out	20	13
ZA000.02015 Selling out	20	15
ZA000.02016	20	16
ZA000.03015 Selling out	30	15
ZA000.03016	30	16
ZA000.03020	30	20
ZA000.03025	30	25
ZA000.03026	30	25,4
ZA000.03028 Selling out	30	28,6
ZA000.03220 NEW	32	20
ZA000.03230	32	30
ZA000.03516 NEW	35	16
ZA000.03520 NEW	35	20
ZA000.03526 NEW	35	26
ZA000.03530	35	30
ZA000.03532 NEW	35	32
ZA000.04030 NEW	40	30
ZA000.04032 NEW	40	32
ZA000.04035 NEW	40	35

REDUCTION RINGS FOR CUTTERHEADS

ART. ZA010

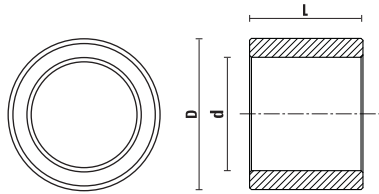

Tolerance:

D= 0/- 0,02

d= + 0,02/0

L= ± 0,02

Item	D	d	L
ZA010.322020 NEW	32	20	20
ZA010.353005 NEW	35	30	5
ZA010.353010 NEW	35	30	10
ZA010.353015 NEW	35	30	15
ZA010.353020 NEW	35	30	20
ZA010.353025 NEW	35	30	25
ZA010.353030 NEW	35	30	30
ZA010.353035 NEW	35	30	35
ZA010.353040 NEW	35	30	40
ZA010.403005 NEW	40	30	5
ZA010.403010 NEW	40	30	10
ZA010.403015 NEW	40	30	15
ZA010.403020 NEW	40	30	20
ZA010.403025 NEW	40	30	25
ZA010.403030 NEW	40	30	30
ZA010.403035 NEW	40	30	35
ZA010.403040 NEW	40	30	40
ZA010.403505 NEW	40	35	5
ZA010.403510 NEW	40	35	10
ZA010.403515 NEW	40	35	15
ZA010.403520 NEW	40	35	20
ZA010.403525 NEW	40	35	25
ZA010.403530 NEW	40	35	30
ZA010.403535 NEW	40	35	35
ZA010.403540 NEW	40	35	40

REDUCING BUSHES

ART. ZA011

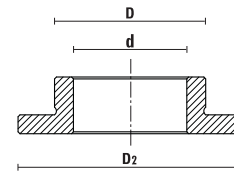

Tolerance:

D= 0/- 0,02

d= + 0,02/0

Item	D	d	D2
ZA011.03530 NEW	35	30	55
ZA011.04030 NEW	40	30	60
ZA011.04035 NEW	40	35	55
ZA011.05030 NEW	50	30	70
ZA011.05035 NEW	50	35	70
ZA011.05040 NEW	50	40	70

SPACERS

ART. YD300 - YD350 - YD400

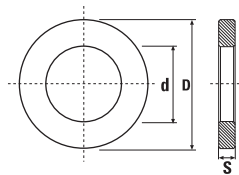
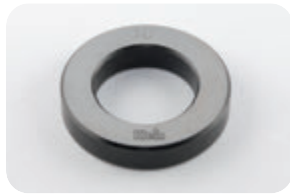

- For arbors Art. T128 - Art. T130 - Art. T131 - Art. T132
- Burnished
- Spacer rings fine-blanking processed for thickness 0,1÷1 mm (tolerance ± 0,02)
- Spacer rings grinded on two sides for thickness 2÷50 mm (tolerance ± 0,01)

Item	D	d	S
YD300.001 NEW	30	50	0,1
YD300.002 NEW	30	50	0,2
YD300.005 NEW	30	50	0,5
YD300.010 NEW	30	50	1
YD300.020	30	50	2
YD300.030	30	50	3
YD300.040	30	50	4
YD300.050	30	50	5
YD300.060	30	50	6
YD300.080	30	50	8
YD300.100	30	50	10
YD300.120	30	50	12
YD300.150 NEW	30	50	15
YD300.200	30	50	20
YD300.250	30	50	25
YD300.300	30	50	30
YD300.400 NEW	30	50	40
YD300.500 NEW	30	50	50
YD350.001 NEW	35	55	0,1
YD350.002 NEW	35	55	0,2
YD350.005 NEW	35	55	0,5
YD350.010 NEW	35	55	1
YD350.020	35	55	2
YD350.030	35	55	3
YD350.040	35	55	4
YD350.050	35	55	5
YD350.060	35	55	6
YD350.080	35	55	8
YD350.100	35	55	10
YD350.120	35	55	12
YD350.150 NEW	35	55	15
YD350.200	35	55	20
YD350.250	35	55	25
YD350.300	35	55	30
YD350.400 NEW	35	55	40
YD350.500 NEW	35	55	50

Item	D	D1	S
YD400.001 NEW	40	60	0,1
YD400.002 NEW	40	60	0,2
YD400.005 NEW	40	60	0,5
YD400.010 NEW	40	60	1
YD400.020	40	60	2
YD400.030	40	60	3
YD400.040	40	60	4
YD400.050	40	60	5
YD400.060	40	60	6
YD400.080	40	60	8
YD400.100	40	60	10
YD400.120	40	60	12
YD400.150 NEW	40	60	15
YD400.200	40	60	20
YD400.250	40	60	25
YD400.300	40	60	30
YD400.400 NEW	40	60	40
YD400.500 NEW	40	60	50
YD500.001 NEW	50	70	0,1
YD500.002 NEW	50	70	0,2
YD500.005 NEW	50	70	0,5
YD500.010 NEW	50	70	1
YD500.020 NEW	50	70	2
YD500.030 NEW	50	70	3
YD500.040 NEW	50	70	4
YD500.050 NEW	50	70	5
YD500.060 NEW	50	70	6
YD500.080 NEW	50	70	8
YD500.100 NEW	50	70	10
YD500.120 NEW	50	70	12
YD500.150 NEW	50	70	15
YD500.200 NEW	50	70	20
YD500.250 NEW	50	70	25
YD500.300 NEW	50	70	30
YD500.400 NEW	50	70	40
YD500.500 NEW	50	70	50
YD600.001 NEW	60	80	0,1
YD600.002 NEW	60	80	0,2
YD600.005 NEW	60	80	0,5
YD600.010 NEW	60	80	1
YD600.020 NEW	60	80	2
YD600.030 NEW	60	80	3
YD600.040 NEW	60	80	4
YD600.050 NEW	60	80	5
YD600.060 NEW	60	80	6
YD600.080 NEW	60	80	8
YD600.100 NEW	60	80	10
YD600.120 NEW	60	80	12
YD600.150 NEW	60	80	15
YD600.200 NEW	60	80	20
YD600.250 NEW	60	80	25
YD600.300 NEW	60	80	30
YD600.400 NEW	60	80	40
YD600.500 NEW	60	80	50



SPACERS SET

ART. YD300 - YD350 - YD400 - YD500 - YD600

Item	D	D1
YD300.990	30	50
YD350.990	35	55
YD400.990	40	60
YD500.990 NEW	50	70
YD600.990 NEW	60	80

Complete with:

- nr. 4 sp. 2 mm - nr. 3 sp. 4 mm - nr. 2 sp. 5 mm
- nr. 2 sp. 10 mm - nr. 1 sp. 20 mm - nr. 1 sp. 30 mm

Reversible knives and knives for planers



11



HW STANDARD REVERSIBLE KNIVES
Page 11.04



HW STANDARD REVERSIBLE KNIVES
Page 11.04



HW STANDARD REVERSIBLE KNIVES
Page 11.04



HW STANDARD REVERSIBLE KNIVES
Page 11.05



HW STANDARD REVERSIBLE KNIVES
Page 11.05

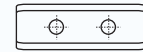

HW SPECIAL KNIVES
Page 11.05



HW SPECIAL KNIVES
Page 11.05



HW STANDARD REVERSIBLE KNIVES
Page 11.05



HW STANDARD REVERSIBLE KNIVES
Page 11.05



HW STANDARD REVERSIBLE KNIVES
Page 11.06



HW STANDARD REVERSIBLE KNIVES
Page 11.06

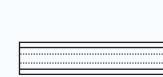

HW REVERSIBLE KNIVES "MINI"
Page 11.06



HW REVERSIBLE KNIVES "MINI"
Page 11.06



HW "VERSOFIX" KNIVES
Page 11.06



HW EDGE ROUNDING KNIVES
Page 11.06



HW STANDARD REVERSIBLE KNIVES
Page 11.08



HW STANDARD REVERSIBLE KNIVES
Page 11.08



HW STANDARD REVERSIBLE KNIVES
Page 11.08



HW STANDARD REVERSIBLE KNIVES
Page 11.08



HW STANDARD REVERSIBLE KNIVES
Page 11.08



HW SPECIAL KNIVES
Page 11.08

11



KleinDIA



HW SPECIAL KNIVES
Page 11.09

KleinDIA



HW STANDARD REVERSIBLE KNIVES
Page 11.09

KleinDIA



HW STANDARD REVERSIBLE KNIVES
Page 11.09

KleinDIA



HW STANDARD REVERSIBLE KNIVES
Page 11.09

KleinDIA



HW STANDARD REVERSIBLE KNIVES
Page 11.09

KleinDIA



HW REVERSIBLE KNIVES "MINI"
Page 11.09

KleinDIA



HW REVERSIBLE KNIVES "MINI"
Page 11.09



HW EDGE ROUNDING KNIVES
Page 11.09



KNIVES FOR PORTABLE PLANERS
Page 11.10



HW TURNBLADE KNIVES
FOR PORTABLE PLANERS
Page 11.10



LAMINATE CUTTERS
Page 11.11



MAGNETIC ALIGNERS
FOR PLANER KNIVES
Page 11.11



PLANER KNIVES H=30/35 - HS=18% W
Page 11.11



PLANER KNIVES H=30/35 - HL=13% Cr
Page 11.12

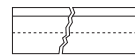

PLANER KNIVES H=30/35 - HW=TCT
Page 11.12

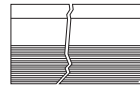

CORRUGATED BLANK KNIVES
HS: 18% W
Page 11.13

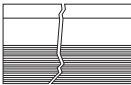

HW CORRUGATED BLANK KNIVES
Page 11.13



TURNBLADES "TERSA"
Page 11.14



TURNBLADES "CENTROLOCK"
Page 11.14



TURNBLADES "CENTROFIX"
QUICKFIX" - "CENTROSTAR"
Page 11.14



TURNBLADES "TERMINUS"
Page 11.15



TURNBLADES "BULLDOZER"
Page 11.15



TURNBLADES "ENSHIN"
Page 11.15



TURNBLADES "SINUS"
Page 11.15



TURNBLADES "VARIPLAN"
Page 11.16



TURNBLADES "BRUCK"
Page 11.16



TURNBLADES "ESTA"
Page 11.16

REVERSIBLE KNIVES

Grades and application chart

Grades	Code USA	Code ISO	Cobalt	Density	Hardness	Softwood	Hardwood	Chipboard	MDF
Fine grain			%	gr/cm ³	HV10				
HC05 (HL05)	C3	K10	4	15.15	1760	X	X	XX	X
HC20 (HL15)	C2	K20	6	14.95	1640	XX	XX	X	-
HC27 (HL30)	C1	K30	7,5	14.70	1470	XX	XX	X	-
HC35 (HL40)	C1	K30	9	14.60	1400	XX	X	-	-

Micro grain

MG06 (DO50)	C4	K01	3.3	15.20	2020	-	-	X	XX
MG18 (HL20F)	C2	K20	10	14.50	1680	X	XX	-	-

Ultra fine grain

SMG02	-	-	2,5	15.25	2350	-	-	X	XX
--------------	---	---	-----	-------	------	---	---	---	----

Nano grain

UMG04	-	-	2	15.30	2550	-	-	-	XX
--------------	---	---	---	-------	------	---	---	---	----

Micro grain

KCR08	-	-	3,2	15.20	1920	XX	XX	XX	XX
--------------	---	---	-----	-------	------	----	----	----	----

HC05 - HC20 - HC27 - HC35

This is the most widely used grade for indexable knives and profile blanks. Good performance on the whole range of materials used today in the woodworking industry. This grade sets the standard for performance and price

MG06

This micrograin carbide is harder than HC05 and can increase tool life by 50% when used on MDF.

MG18

By virtue of its micrograin structure MG18 is the optimum grade for 45° cutting edges. It creates a sharp, tough and wear resistant edge. This makes it ideal for machining hardwoods and brings the benefit of increased tool life.

SMG02

This is an even harder micrograin grade giving an increase of 100% in tool life compared with MG06. It allows longer production runs on MDF.

UMG04

Tests have shown tool life increased by 3 times compared to SMG02 or 9 times the life of standard grades. For cutting very hard materials this is an economical alternative to DP tools with far less financial risk should breakage occur.

KCR08

Covers 99% of all applications (soft and hard wood, melamine, HDF, MDF).
More precise cutting edge execution due to submicrograin grade.
High corrosion resistance due to special power mix.

Grain size definition	Average grain size range
Nano grain	< 0,2 µm
Ultrafine grain	0,2 < 0,5 µm
Micrograin	0,5 < 0,8 µm
Fine grain	0,8 < 1,3 µm
Medium grain	1,3 < 2,5 µm
Coarse grain	2,5 < 6,0 µm



HW STANDARD REVERSIBLE KNIVES

ART. Z055 - Z155 - Z255 - Z355 - Z455 - Z555

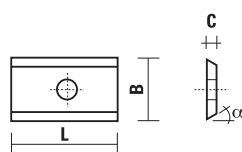

10 pcs. set

- 2 cutting edges
- 1 fixing hole

Item	Grade	L	B	C	α
Z055.000.N	HC05	7,5	12	1,5	35°
Z055.012.N	HC05	9,6	12	1,5	35°
Z055.013.N	HC05	10,5	12	1,5	35°
Z055.002.N	HC05	15	12	1,5	35°
Z055.003.N	HC05	20	12	1,5	35°
Z055.014.N	HC05	25	12	1,5	35°
Z055.900.N	HC05	7,5	9	1,5	35°
Z055.901.N	HC05	12	9	1,5	35°
Z055.903.N	HC05	20	9	1,5	35°
Z155.000.N	MG06	7,5	12	1,5	35°
Z155.003.N	MG06	20	12	1,5	35°
Z255.003.N	SMG02	20	12	1,5	35°
Z355.003.N	UMG04	20	12	1,5	35°
Z455.000.N	MG18	7,5	12	1,5	45°
Z455.012.N	MG18	9,6	12	1,5	45°
Z455.002.N	MG18	15	12	1,5	45°
Z455.003.N	MG18	20	12	1,5	45°
Z555.000.N NEW	KCR08	7,5	12	1,5	35°
Z555.012.N NEW	KCR08	9,6	12	1,5	35°
Z555.002.N NEW	KCR08	15	12	1,5	35°
Z555.003.N NEW	KCR08	20	12	1,5	35°
Z555.014.N NEW	KCR08	25	12	1,5	35°

HW STANDARD REVERSIBLE KNIVES

ART. Z055 - Z355

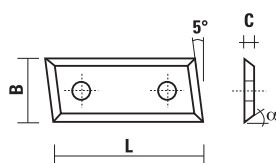

10 pcs. set

- 4 cutting edges
- 2 fixing holes
- 5° right

Item	Grade	L	B	C	α
Z055.423.N	HC05	30	9	1,5	35°
Z055.424.N	HC05	40	9	1,5	35°
Z055.425.N	HC05	50	9	1,5	35°
Z055.430.N	HC05	30	12	1,5	35°
Z055.440.N	HC05	40	12	1,5	35°
Z055.450.N	HC05	50	12	1,5	35°
Z355.450.N NEW	UMG04	50	12	1,5	35°

HW STANDARD REVERSIBLE KNIVES

ART. Z055 - Z155 - Z255 - Z355 - Z455 - Z555

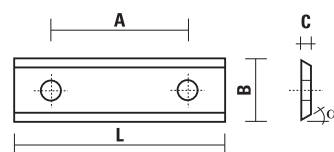

10 pcs. set

- 2 cutting edges
- 2 fixing holes

Item	Grade	L	B	C	α	A
Z055.015.N	HC05	25	12	1,5	35°	14
Z055.008.N	HC05	30	12	1,5	35°	14
Z055.009.N	HC05	40	12	1,5	35°	26
Z055.010.N	HC05	50	12	1,5	35°	26
Z055.011.N	HC05	60	12	1,5	35°	26
Z055.070.N	HC27	80	13	2,2	35°	60
Z055.071.N	HC27	100	13	2,2	35°	60
Z055.072.N	HC27	120	13	2,2	35°	60
Z055.073.N NEW	HC27	130	13	2,2	35°	60
Z055.908.N	HC05	30	9	1,5	35°	14
Z055.909.N	HC05	40	9	1,5	35°	26
Z055.910.N	HC05	50	9	1,5	35°	26
Z155.008.N	MG06	30	12	1,5	35°	14
Z155.009.N	MG06	40	12	1,5	35°	26
Z155.010.N	MG06	50	12	1,5	35°	26
Z155.011.N	MG06	60	12	1,5	35°	26
Z255.008.N	SMG02	30	12	1,5	35°	14
Z255.009.N	SMG02	40	12	1,5	35°	26
Z255.010.N	SMG02	50	12	1,5	35°	26
Z255.011.N	SMG02	60	12	1,5	35°	26
Z355.008.N	UMG04	30	12	1,5	35°	14
Z355.010.N	UMG04	50	12	1,5	35°	26
Z455.008.N	MG18	30	12	1,5	45°	14
Z455.009.N	MG18	40	12	1,5	45°	26
Z455.010.N	MG18	50	12	1,5	45°	26
Z455.011.N	MG18	60	12	1,5	45°	26
Z455.980.N	MG18	80	13	2,2	45°	60
Z555.015.N NEW	KCR08	25	12	1,5	35°	14
Z555.008.N NEW	KCR08	30	12	1,5	35°	14
Z555.009.N NEW	KCR08	40	12	1,5	35°	26
Z555.010.N NEW	KCR08	50	12	1,5	35°	26
Z555.011.N NEW	KCR08	60	12	1,5	35°	26
Z555.070.N NEW	KCR08	80	13	2,2	35°	60
Z555.071.N NEW	KCR08	100	13	2,2	35°	60
Z555.072.N NEW	KCR08	120	13	2,2	35°	60

HW STANDARD REVERSIBLE KNIVES

ART. Z055

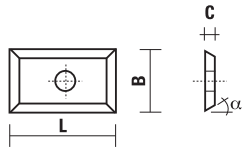

10 pcs. set

- 4 cutting edges
- 1 fixing hole

Item	Grade	L	B	C	α
Z055.319.N	HC05	19,5	12	1,5	35°
Z055.320.N	HC05	19,5	9	1,5	35°

HW STANDARD REVERSIBLE KNIVES

ART. Z055 - Z255 - Z355 - Z555

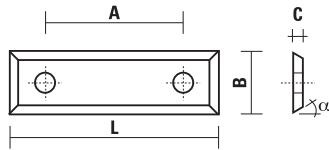

10 pcs. set

- 4 cutting edges
- 2 fixing holes

Item	Grade	L	B	C	α	A
Z055.329.N	HC05	29,5	12	1,5	35°	14
Z055.340.N	HC05	39,5	12	1,5	35°	26
Z055.349.N	HC05	49,5	12	1,5	35°	26
Z055.330.N	HC05	29,5	9	1,5	35°	14
Z055.341.N	HC05	39,5	9	1,5	35°	26
Z055.350.N	HC05	49,5	9	1,5	35°	26
Z255.329.N	SMG02	29,5	12	1,5	35°	14
Z255.340.N	SMG02	39,5	12	1,5	35°	26
Z255.349.N	SMG02	49,5	12	1,5	35°	26
Z355.349.N	UMG04	49,5	12	1,5	35°	26
Z555.329.N NEW	KCR08	29,5	12	1,5	35°	14
Z555.340.N NEW	KCR08	39,5	12	1,5	35°	26
Z555.350.N NEW	KCR08	49,5	12	1,5	35°	26

HW SPECIAL KNIVES

ART. Z055

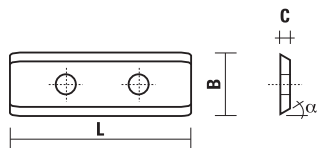

10 pcs. set

- 2 cutting edges
- 2 fixing holes

Item	Grade	L	B	C	α
Z055.033.N	HC05	30	12	1,5	35°
Z055.035.N	HC05	50	12	1,5	35°

HW SPECIAL KNIVES

ART. Z055

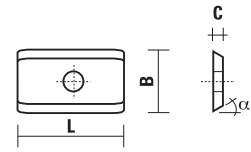

10 pcs. set

- 2 cutting edges
- 1 fixing hole

Item	Grade	L	B	C	α
Z055.032.N	HC05	20	12	1,5	35°

HW STANDARD REVERSIBLE KNIVES

ART. Z055 - Z155 - Z255 - Z455 - Z555

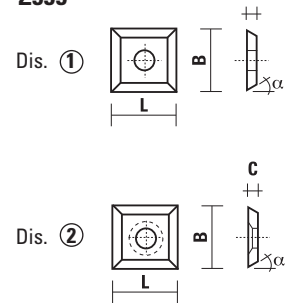
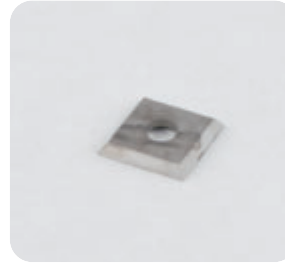

10 pcs. set

- 4 cutting edges
- 1 fixing hole

Item	Grade	Drawing	L	B	C	α
Z055.016.N	HC05	1	10,5	10,5	1,5	35°
Z055.001.N	HC05	1	12	12	1,5	35°
Z055.006.N	HC35	2	14	14	1,2	30°
Z055.007.N	HC35	2	14	14	2	30°
Z155.001.N	MG06	1	12	12	1,5	35°
Z155.007.N	MG06	2	14	14	2	30°
Z255.001.N	SMG02	1	12	12	1,5	35°
Z255.007.N	SMG02	2	14	14	2	30°
Z455.001.N	MG18	1	12	12	1,5	45°
Z455.007.N	MG18	2	14	14	2	45°
Z555.001.N NEW	KCR08	1	12	12	1,5	35°
Z555.007.N NEW	KCR08	2	14	14	2	30°

HW STANDARD REVERSIBLE KNIVES

ART. Z055

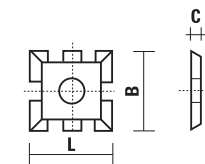

10 pcs. set

- 4 cutting edges
- 1 fixing hole

Item	Grade	L	B	C
Z055.019.N	HC27	15	15	2

HW STANDARD REVERSIBLE KNIVES

ART. Z055

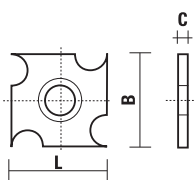

10 pcs. set

4 cutting edges

Item	Grade	L	B	C
Z055.020.N	HC20	18	18	1,95
Z055.021.N	HC20	18	18	2,45
Z055.022.N	HC20	18	18	2,95

HW STANDARD REVERSIBLE KNIVES

ART. Z455

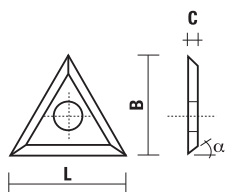

10 pcs. set

3 cutting edges

Item	Grade	L	B	C	α
Z455.030.N	MG18	22	19	2	30°

HW REVERSIBLE KNIVES "MINI"

ART. Z055

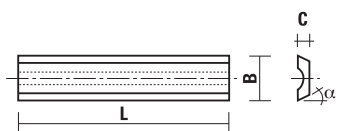

10 pcs. set

- 2 cutting edges
- Front groove

Item	Grade	L	B	C	α
Z055.080.N	HC05	12	5,5	1,1	35°
Z055.081.N	HC05	20	5,5	1,1	35°
Z055.082.N	HC05	30	5,5	1,1	35°
Z055.083.N	HC05	40	5,5	1,1	35°
Z055.084.N	HC05	50	5,5	1,1	35°

HW REVERSIBLE KNIVES "MINI"

ART. Z055

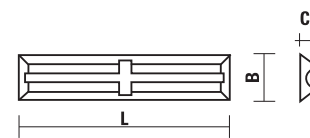

10 pcs. set

- 4 cutting edges
- Back groove with safety notch

Item	Grade	L	B	C	α
Z055.085.N	HC05	20	4,1	1,1	35°
Z055.086.N	HC05	20	5,5	1,1	35°
Z055.087.N	HC05	25	5,5	1,1	35°
Z055.088.N	HC05	30	5,5	1,1	35°
Z055.089.N	HC05	50	5,5	1,1	35°

HW "VERSOFIX" KNIVES

ART. Z055

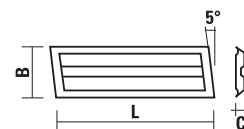

10 pcs. set

- With "Kawedur" coating
- 4 cutting edges
- 5° right

Item	L	B	C
Z055.220.N	20	5,5	1,1
Z055.221.N	20	10	1,5
Z055.230.N	30	6,5	1,1
Z055.231.N	30	10	1,5
Z055.250.N	50	10	1,5

HW EDGE ROUNDING KNIVES

ART. Z060

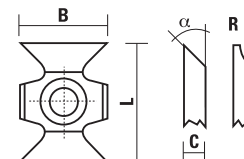

10 pcs. set

Item	Grade	L	B	C	α/R
Z060.000.N	HC20	22	16	5	45°
Z060.015.N	HC20	22	16	5	R=1,5
Z060.020.N	HC20	22	16	5	R=2
Z060.030.N	HC20	22	16	5	R=3
Z060.050.N	HC20	22	16	5	R=5

KleinDIA

A surface treatment developed for large-scale production

KleinDIA is a DLC (**Diamond-like Carbon**) anti-friction coating which allows to solve problems of tool abrasion, chip evacuation and chemical attack.

A layer of approx. 1 micron is laid on the tool surface at low temperature, thus not altering the properties of the router bit or knife.

Its high hardness is granted by both Sp2 (**Graphite**) and Sp3 (**Diamond**) carbon hybridisation.

Our several tests confirmed remarkable results on both panel working and solid wood processing.

Working plastic and aluminium without coolant is also possible thanks to a very low friction coefficient.

TECHNICAL FEATURES:

- **High hardness** Hv0,025: 2500-3100
- **Higher wear resistance** (longer working time)
- **Low frictional coefficient** (lowered working temperature)
- **Very low sticking coefficient** (Better chips evacuation)
- **Thickness:** approx. 1 micron
- **Colour:** bright black



KleinDIA is the most advantageous coating, ensuring:

- **Production increase**
- **Better finishing**
- **Less maintenance**

The surface coating **KleinDIA** can be applied on many other products giving extraordinary results depending on the type of material processed. Excellent results can be achieved processing solid wood, plywood, Plexiglas, plastic and graphitic materials.

HERE ARE SOME OF THE ITEMS WHICH ARE SUITABLE TO BE COATED WITH **KleinDIA**:

Solid carbide straight router bits
ART. A101/2/3 - C101/2/3 - C190 - D101/2



Pag. 5.9

Solid carbide spiral router bits
ART. T141/2/3 - T151/2/3 - T157/8/9



Page from 7.36 to 7.46

Solid carbide dowel drills
ART. L116 - L117



Page 1.07, 1.23, 2.05

Solid carbide through-hole boring bits
ART. L134 - L135



Pag. 5.12

HW reversible knives
ART. ZB



Pag. 11.10

HS planer knives
ART. ZC 30 - ZC 35

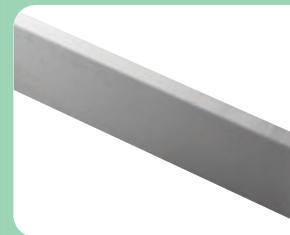

Pag. 11.11, 11.12, 11.13



HW STANDARD REVERSIBLE KNIVES

ART. Z055 - Z155 - Z255 - Z355 - Z455

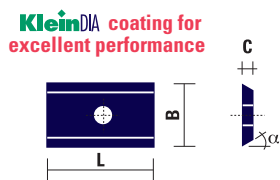
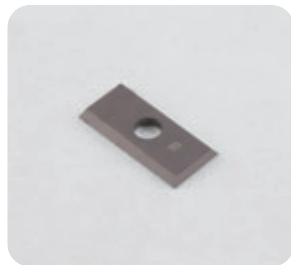

10 pcs. set

- 2 cutting edges
- 1 fixing hole

Item	Grade	L	B	C	α
Z055.000.NKD NEW	HC05	7,5	12	1,5	35°
Z055.012.NKD NEW	HC05	9,6	12	1,5	35°
Z055.013.NKD NEW	HC05	10,5	12	1,5	35°
Z055.002.NKD NEW	HC05	15	12	1,5	35°
Z055.003.NKD NEW	HC05	20	12	1,5	35°
Z055.014.NKD NEW	HC05	25	12	1,5	35°
Z055.900.NKD NEW	HC05	7,5	9	1,5	35°
Z055.901.NKD NEW	HC05	12	9	1,5	35°
Z055.903.NKD NEW	HC05	20	9	1,5	35°

HW STANDARD REVERSIBLE KNIVES

ART. Z055 - Z155 - Z255 - Z355 - Z455

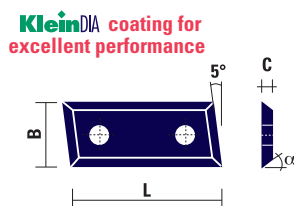

10 pcs. set

- 4 cutting edges
- 2 fixing holes
- 5° right

Item	Grade	L	B	C	α
Z055.423.NKD NEW	HC05	30	9	1,5	35°
Z055.424.NKD NEW	HC05	40	9	1,5	35°
Z055.425.NKD NEW	HC05	50	9	1,5	35°
Z055.430.NKD NEW	HC05	30	12	1,5	35°
Z055.440.NKD NEW	HC05	40	12	1,5	35°
Z055.450.NKD NEW	HC05	50	12	1,5	35°

HW STANDARD REVERSIBLE KNIVES

ART. Z055 - Z155 - Z255 - Z355 - Z455

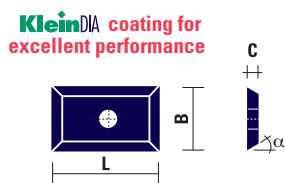
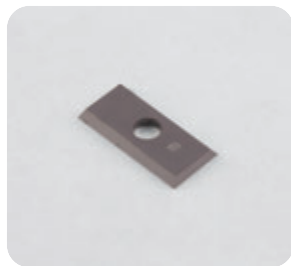

10 pcs. set

- 4 cutting edges
- 1 fixing hole

Item	Grade	L	B	C	α
Z055.319.NKD NEW	HC05	19,5	12	1,5	35°
Z055.320.NKD NEW	HC05	19,5	9	1,5	35°

HW STANDARD REVERSIBLE KNIVES

ART. Z055

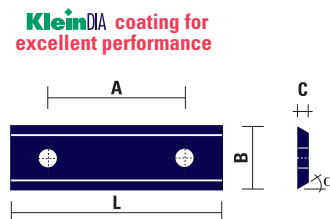

10 pcs. set

- 2 cutting edges
- 2 fixing holes

Item	Grade	L	B	C	α	A
Z055.015.NKD NEW	HC05	25	12	1,5	35°	14
Z055.008.NKD NEW	HC05	30	12	1,5	35°	14
Z055.009.NKD NEW	HC05	40	12	1,5	35°	26
Z055.010.NKD NEW	HC05	50	12	1,5	35°	26
Z055.011.NKD NEW	HC05	60	12	1,5	35°	26
Z055.908.NKD NEW	HC05	30	9	1,5	35°	14
Z055.909.NKD NEW	HC05	40	9	1,5	35°	26
Z055.910.NKD NEW	HC05	50	9	1,5	35°	26

HW STANDARD REVERSIBLE KNIVES

ART. Z055 - Z155 - Z255 - Z355 - Z455 - Z555

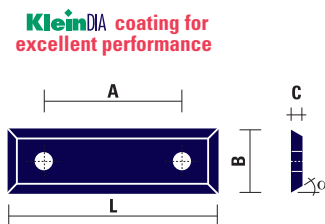

10 pcs. set

- 4 cutting edges
- 2 fixing holes

Item	Grade	L	B	C	α	A
Z055.329.NKD NEW	HC05	29,5	12	1,5	35°	14
Z055.340.NKD NEW	HC05	39,5	12	1,5	35°	26
Z055.349.NKD NEW	HC05	49,5	12	1,5	35°	26
Z055.330.NKD NEW	HC05	29,5	9	1,5	35°	14
Z055.341.NKD NEW	HC05	39,5	9	1,5	35°	26
Z055.350.NKD NEW	HC05	49,5	9	1,5	35°	26

HW SPECIAL KNIVES

ART. Z055

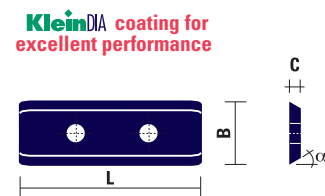

10 pcs. set

- 2 cutting edges
- 2 fixing holes

Item	Grade	L	B	C	α
Z055.033.NKD NEW	HC05	30	12	1,5	35°
Z055.035.NKD NEW	HC05	50	12	1,5	35°

HW SPECIAL KNIVES

ART. Z055

KleinDIA coating for excellent performance

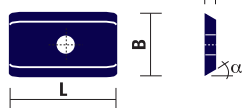

10 pcs. set

- 2 cutting edges
- 1 fixing hole

Item	Grade	L	B	C	α
Z055.032.NKD NEW	HC05	20	12	1,5	35°

HW STANDARD REVERSIBLE KNIVES

ART. Z055 - Z155 - Z255 - Z455

KleinDIA coating for excellent performance

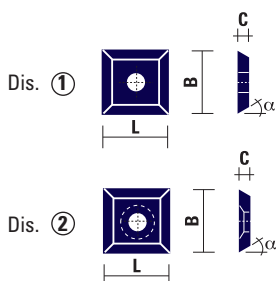
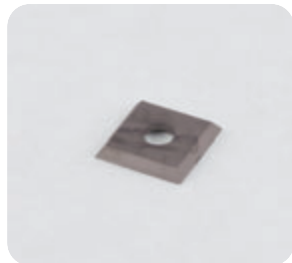

10 pcs. set

- 4 cutting edges
- 1 fixing hole

Item	Grade	Drawing	L	B	C	α
Z055.016.NKD NEW	HC05	1	10,5	10,5	1,5	35°
Z055.001.NKD NEW	HC05	1	12	12	1,5	35°
Z055.006.NKD NEW	HC35	2	14	14	1,2	30°
Z055.007.NKD NEW	HC35	2	14	14	2	30°

HW STANDARD REVERSIBLE KNIVES

ART. Z055 - Z155 - Z255 - Z455

KleinDIA coating for excellent performance

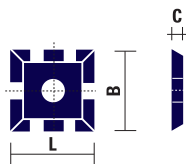

10 pcs. set

- 4 cutting edges
- 1 fixing hole

Item	Grade	L	B	C
Z055.019.NKD NEW	HC27	15	15	2

HW STANDARD REVERSIBLE KNIVES

ART. Z055

KleinDIA coating for excellent performance

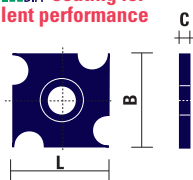

10 pcs. set

4 cutting edges

Item	Grade	L	B	C
Z055.020.NKD NEW	HC20	18	18	1,95
Z055.021.NKD NEW	HC20	18	18	2,45
Z055.022.NKD NEW	HC20	18	18	2,95

HW STANDARD REVERSIBLE KNIVES

ART. Z055

KleinDIA coating for excellent performance

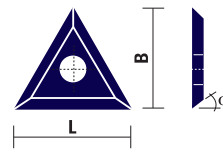

10 pcs. set

3 cutting edges

Item	Grade	L	B	C	α
Z455.030.NKD NEW	MG18	22	19	2	30°

HW REVERSIBLE KNIVES "MINI"

ART. Z055

KleinDIA coating for excellent performance



10 pcs. set

- 2 cutting edges
- Front groove

Item	Grade	L	B	C	α
Z055.080.NKD NEW	HC05	12	5,5	1,1	35°
Z055.081.NKD NEW	HC05	20	5,5	1,1	35°
Z055.082.NKD NEW	HC05	30	5,5	1,1	35°
Z055.083.NKD NEW	HC05	40	5,5	1,1	35°
Z055.084.NKD NEW	HC05	50	5,5	1,1	35°

HW REVERSIBLE KNIVES "MINI"

ART. Z055

KleinDIA coating for excellent performance

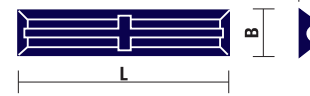

10 pcs. set

- 4 cutting edges
- Back groove with safety notch

Item	Grade	L	B	C	α
Z055.085.NKD NEW	HC05	20	4,1	1,1	35°
Z055.086.NKD NEW	HC05	20	5,5	1,1	35°
Z055.087.NKD NEW	HC05	25	5,5	1,1	35°
Z055.088.NKD NEW	HC05	30	5,5	1,1	35°
Z055.089.NKD NEW	HC05	50	5,5	1,1	35°

HW EDGE ROUNDING KNIVES

ART. Z060

KleinDIA coating for excellent performance

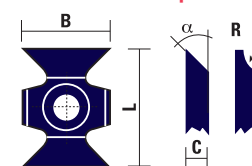
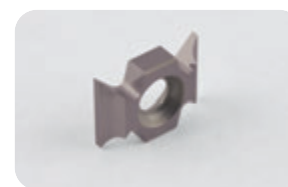

10 pcs. set

Item	Grade	L	B	C	α/R
Z060.000.NKD NEW	HC20	22	16	5	45°
Z060.015.NKD NEW	HC20	22	16	5	R=1,5
Z060.020.NKD NEW	HC20	22	16	5	R=2
Z060.030.NKD NEW	HC20	22	16	5	R=3
Z060.050.NKD NEW	HC20	22	16	5	R=5

KNIVES FOR PORTABLE PLANERS

Item	L	H	S	Machine model	
Z080.001.N	75	17	3	HW Bosch	
Z081.001.N	75	17	3	HS Bosch	
Z080.010.N	82	28	3	HW Hitachi	
Z081.010.N	82	28	3	HS Hitachi	
Z080.020.N	77	27	3	HW Elu	
Z081.020.N	77	27	3	HS Elu	
Z080.021.N	80	27	3	HW Elu	
Z081.021.N	80	27	3	HS Elu	
Z080.030.N	75	36	3	HW Stayer	
Z081.030.N	75	36	3	HS Stayer	
Z080.031.N	82	30	3	HW Stayer	
Z081.031.N	82	30	3	HS Stayer	
Z080.040.N	80	29	3	HW Star	
Z081.040.N	80	29	3	HS Star	
Z080.050.N	82	29	3	HW Makita	
Z081.050.N	82	29	3	HS Makita	
Z080.052.N	110	29	3	HW Makita	
Z081.052.N	110	29	3	HS Makita	
Z080.051.N	155	33	3	HW Makita	
Z081.051.N	155	33	3	HS Makita	
Z080.053.N	170	35	3	HW Makita	
Z081.053.N	170	35	3	HS Makita	
Z080.059.N	260	25	3	HW Emco	
Z080.062.N	92	28	3	HW Towa	
Z081.062.N	92	28	3	HS Towa	
Z080.070.N	58	17	2,8	HW Tomesani	
Z081.070.N	58	17	2,8	HS Tomesani	
Z080.080.N	260	21	3	HW Dewalt	
Z081.080.N	260	21	3	HS Dewalt	
Z080.090.N	99	31,5	5,8	HW Elind	

HW TURNBLADE KNIVES FOR PORTABLE PLANERS

ART. ZB



10 pcs. set

Item	Dimension	Machine model
ZB0755	75,5X5,5X1,1	AEG HTH75 BLACK & DECKER DN75, 750SR, 600K BOSCH 0590, 1590, 1591, P400 FESTO REP75 HAFFNER FH222 HOLZ-HER 2223, 2286, 2320 KRESS JET-STAR 6701, 6702 MAFELL HU75 METABO 6375 SCHEER MH75/3, MH80 SKIL 98H
ZB0805	80,5X5,9X1,2	ELU MFF40, MFF80, PF161, MFF81, MFF81EK
ZB0820	82X5,5X1,1	AEG EH450, EH825, EH700, EH700R EH822, H500, H750 BLACK & DECKER DN710, DN712, DN730 BOSCH PH0282, PH0382 CASALS CE82 FEIN HS2151 FELISATTI TP282 HAFFNER FH224 HITACHI F20, F20A, P20V, P20SA, FP20A HOLZ-HER 2223, 2321 LEGNA R82, G82 MAFELL MHU82 MAKITA 1001, 1100, 1900, 1901, 1125B, 1923B, 1923H, 1923HO METABO 0882, 0883, EO983, 3360, 4382, 8382 PERLES HHH82B PEUGEOT BRA3-82, BR82, RA400, 82RAC, RA1082CA SKIL 92H, 94H, 96H, 1506, 1510 STAYER 980B
ZB0920	92X5,5X1,1	HITACHI F30A RYOBI L120N, 1323 TOWA
ZB1030	103X5,5X1,1	AEG EH102, HB750, HBE800

2 PIECE HANGING PACKAGING

ZB0755x2	75x5,5x1,1
ZB0855x2	80,5x5,9x1,2
ZB0820x2	82x5,5x1,1
ZB0920x2	92x5,5x1,1
ZB1030x2	103x5,5x1,1



LAMINATE CUTTERS

ART. Y100

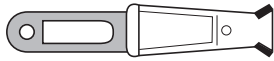

Item	Description
Y100.001.R	Two identical knives for cutting: Plastic material, Laminates etc.
Y100.002.R	Two identical knives for cutting: Side A: Laminates etc. Side B: Glass, Tiles etc.

MAGNETIC ALIGNERS FOR PLANER KNIVES

ART. Y200

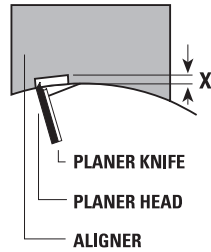

KLEIN magnetic aligners for planer knife shave been specially designed for rapid knife positioning after sharpening. They are made of galvanized steel and feature permanent magnets.

In just a few minutes, in a simple and precise way, problems of knife alignment after sharpening are solved.

No adjustments are required.

Simply position on cutterhead along the step where the knife is to be rested. All your knives will be parallel and positioned with the same working thickness.



Item	∅ Planer head	X
Y200.056.N	56	1
Y200.060.N	60	1
Y200.070.N	70	1
Y200.080.N	80	1
Y200.090.N	90	1
Y200.095.N	95	1
Y200.100.N	100	1
Y200.110.N	110	1
Y200.118.N	118	1
Y200.120.N	120	1
Y200.125.N	125	1
Y200.140.N	140	1

PLANER KNIVES H=30/35

ART. ZC 30 - ZC 35

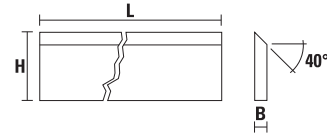
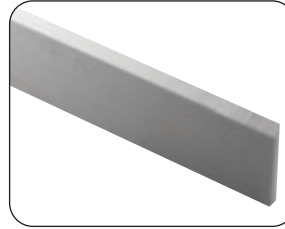

- HS= 18% W, suitable for softwood dry and hardwood wet
- 4 pcs. set

Item	Qal	H	B	L
ZC30.060HS	HS	30	3	60
ZC30.080HS	HS	30	3	80
ZC30.100HS	HS	30	3	100
ZC30.120HS	HS	30	3	120
ZC30.180HS	HS	30	3	180
ZC30.200HS	HS	30	3	200
ZC30.210HS	HS	30	3	210
ZC30.230HS	HS	30	3	230
ZC30.250HS	HS	30	3	250
ZC30.260HS	HS	30	3	260
ZC30.300HS	HS	30	3	300
ZC30.310HS	HS	30	3	310
ZC30.350HS	HS	30	3	350
ZC30.410HS	HS	30	3	410
ZC30.430HS	HS	30	3	430
ZC30.500HS	HS	30	3	500
ZC30.510HS	HS	30	3	510
ZC30.520HS	HS	30	3	520
ZC30.530HS	HS	30	3	530
ZC30.600HS	HS	30	3	600
ZC30.610HS	HS	30	3	610
ZC30.630HS	HS	30	3	630
ZC30.810HS	HS	30	3	810
ZC30.999HS	HS	30	3	1000
ZC35.300HS	HS	35	3	300
ZC35.310HS	HS	35	3	310
ZC35.350HS	HS	35	3	350
ZC35.400HS	HS	35	3	400
ZC35.410HS	HS	35	3	410
ZC35.430HS	HS	35	3	430
ZC35.500HS	HS	35	3	500
ZC35.510HS	HS	35	3	510
ZC35.520HS	HS	35	3	520
ZC35.530HS	HS	35	3	530
ZC35.600HS	HS	35	3	600
ZC35.630HS	HS	35	3	630
ZC35.640HS	HS	35	3	640
ZC35.700HS	HS	35	3	700
ZC35.810HS	HS	35	3	810
ZC35.999HS	HS	35	3	1000

PLANER KNIVES H=30/35

ART. ZC 30 - ZC 35

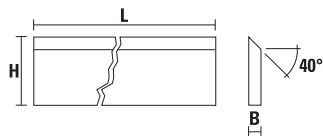
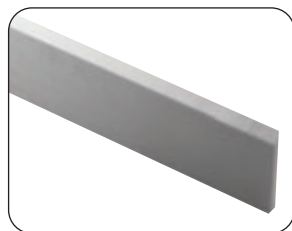

- **HL= 13% Cr**, suitable for softwood wet
- 4 pcs. set

Item	Qal	H	B	L
ZC30.250HL	HL	30	3	250
ZC30.260HL	HL	30	3	260
ZC30.300HL	HL	30	3	300
ZC30.400HL	HL	30	3	400
ZC30.430HL	HL	30	3	430
ZC30.500HL	HL	30	3	500
ZC30.510HL	HL	30	3	510
ZC30.515HL	HL	30	3	515
ZC30.520HL	HL	30	3	520
ZC30.530HL	HL	30	3	530
ZC30.600HL	HL	30	3	600
ZC30.630HL	HL	30	3	630
ZC30.810HL	HL	30	3	810
ZC30.999HL	HL	30	3	1000
ZC35.300HL	HL	35	3	300
ZC35.350HL	HL	35	3	350
ZC35.400HL	HL	35	3	400
ZC35.410HL	HL	35	3	410
ZC35.430HL	HL	35	3	430
ZC35.500HL	HL	35	3	500
ZC35.510HL	HL	35	3	510
ZC35.520HL	HL	35	3	520
ZC35.530HL	HL	35	3	530
ZC35.600HL	HL	35	3	600
ZC35.610HL	HL	35	3	610
ZC35.630HL	HL	35	3	630
ZC35.640HL	HL	35	3	640
ZC35.740HL	HL	35	3	740
ZC35.810HL	HL	35	3	810
ZC35.999HL	HL	35	3	1000

PLANER KNIVES H=30/35

ART. ZC 30 - ZC 35

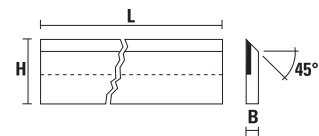
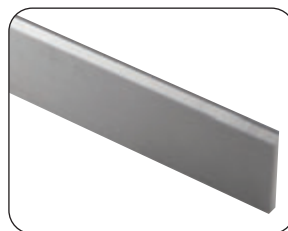

- **HW= TCT**
- 4 pcs. set
- Suitable for hardwood dry and pressed wood

Item	Qal	H	B	L
ZC30.080HW	HW	30	3	80
ZC30.100HW	HW	30	3	100
ZC30.120HW	HW	30	3	120
ZC30.130HW	HW	30	3	130
ZC30.150HW	HW	30	3	150
ZC30.180HW	HW	30	3	180
ZC30.200HW	HW	30	3	200
ZC30.230HW	HW	30	3	230
ZC30.250HW	HW	30	3	250
ZC30.260HW	HW	30	3	260
ZC30.310HW	HW	30	3	310
ZC30.350HW	HW	30	3	350
ZC30.400HW	HW	30	3	400
ZC30.410HW	HW	30	3	410
ZC30.450HW	HW	30	3	450
ZC30.500HW	HW	30	3	500
ZC30.520HW	HW	30	3	520
ZC30.530HW	HW	30	3	530
ZC30.600HW	HW	30	3	600
ZC30.630HW	HW	30	3	630
ZC30.710HW	HW	30	3	710
ZC30.810HW	HW	30	3	810
ZC30.999HW	HW	30	3	1040
ZC35.300HW	HW	35	3	300
ZC35.320HW	HW	35	3	320
ZC35.400HW	HW	35	3	400
ZC35.500HW	HW	35	3	500
ZC35.520HW	HW	35	3	520
ZC35.600HW	HW	35	3	600
ZC35.630HW	HW	35	3	630
ZC35.640HW	HW	35	3	640
ZC35.710HW	HW	35	3	710
ZC35.810HW	HW	35	3	810
ZC35.999HW	HW	35	3	1040

CORRUGATED BLANK KNIVES

ART. ZC 50 - ZC 60 - ZC 70

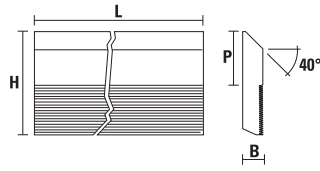

- **HS: 18% W**, suitable for softwood dry or wet and hardwood wet
- Precision serration, angle 60°, pitch 1,6 mm

Item	H	B	L	Pmax
ZC50.060HS	50	8	60	12
ZC50.080HS	50	8	80	12
ZC50.100HS	50	8	100	12
ZC50.120HS	50	8	120	12
ZC50.130HS	50	8	130	12
ZC50.150HS	50	8	150	12
ZC50.180HS	50	8	180	12
ZC50.230HS	50	8	230	12
ZC50.260HS	50	8	260	12
ZC50.650HS	50	8	650	12
ZC60.060HS	60	8	60	20
ZC60.080HS	60	8	80	20
ZC60.100HS	60	8	100	20
ZC60.120HS	60	8	120	20
ZC60.130HS	60	8	130	20
ZC60.150HS	60	8	150	20
ZC60.180HS	60	8	180	20
ZC60.230HS	60	8	230	20
ZC60.260HS	60	8	260	20
ZC60.650HS	60	8	650	20
ZC70.060HS	70	8	60	30
ZC70.080HS	70	8	80	30
ZC70.100HS	70	8	100	30
ZC70.120HS	70	8	120	30
ZC70.130HS	70	8	130	30
ZC70.150HS	70	8	150	30
ZC70.180HS	70	8	180	30
ZC70.230HS	70	8	230	30
ZC70.260HS	70	8	260	30
ZC70.650HS	70	8	650	30

CORRUGATED BLANK KNIVES

ART. ZC 50 - ZC 60 - ZC 70

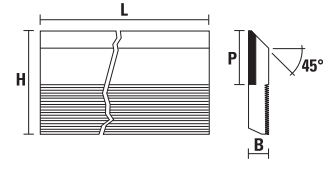
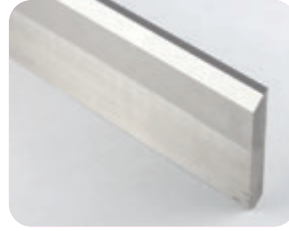

- **HW:** carbide tipped, suitable for hardwood dry, pressed wood
- Precision serration, angle 60°, pitch 1,6 mm

Item	H	B	L	Pmax
ZC50.040HW	50	8	40	20
ZC50.050HW	50	8	50	20
ZC50.060HW	50	8	60	20
ZC50.080HW	50	8	80	20
ZC50.100HW	50	8	100	20
ZC50.120HW	50	8	120	20
ZC50.130HW	50	8	130	20
ZC50.150HW	50	8	150	20
ZC50.180HW	50	8	180	20
ZC50.230HW	50	8	230	20
ZC50.640HW	50	8	640	20
ZC60.040HW	60	8	40	25
ZC60.050HW	60	8	50	25
ZC60.060HW	60	8	60	25
ZC60.080HW	60	8	80	25
ZC60.100HW	60	8	100	25
ZC60.120HW	60	8	120	25
ZC60.130HW	60	8	130	25
ZC60.150HW	60	8	150	25
ZC60.180HW	60	8	180	25
ZC60.230HW	60	8	230	25
ZC60.640HW	60	8	640	25
ZC70.040HW	70	8	40	30
ZC70.050HW	70	8	50	30
ZC70.060HW	70	8	60	30
ZC70.080HW	70	8	80	30
ZC70.100HW	70	8	100	30
ZC70.120HW	70	8	120	30
ZC70.130HW	70	8	130	30
ZC70.150HW	70	8	150	30
ZC70.180HW	70	8	180	30
ZC70.230HW	70	8	230	30
ZC70.640HW	70	8	640	30

TURNBLADES "TERSA"

ART. ZE 01

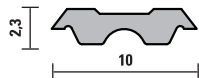

- Antioxidant treatment on knife body
- Polished cutting face for an excellent finish quality
- HS 18% for medium hard wood
- HW for very hard wood and abrasive materials
- M42 for hard wood, long-life performance

Item	Quality	L
ZE01.060HS	HS	60
ZE01.100HS	HS	100
ZE01.130HS	HS	130
ZE01.180HS	HS	180
ZE01.230HS	HS	230
ZE01.310HS	HS	310
ZE01.330HS	HS	330
ZE01.410HS	HS	410
ZE01.430HS	HS	430
ZE01.510HS	HS	510
ZE01.520HS	HS	520
ZE01.530HS	HS	530
ZE01.630HS	HS	630
ZE01.640HS	HS	640
ZE01.060HW	HW	60
ZE01.100HW	HW	100
ZE01.130HW	HW	130
ZE01.180HW	HW	180
ZE01.230HW	HW	230
ZE01.310HW	HW	310
ZE01.330HW	HW	330
ZE01.410HW	HW	410
ZE01.430HW	HW	430
ZE01.510HW	HW	510
ZE01.520HW	HW	520
ZE01.530HW	HW	530
ZE01.630HW	HW	630
ZE01.640HW	HW	640
ZE01.650HW	HW	650
ZE01.060M42	M42	60
ZE01.100M42	M42	100
ZE01.130M42	M42	130
ZE01.180M42	M42	180
ZE01.230M42	M42	230
ZE01.310M42	M42	310
ZE01.330M42	M42	330
ZE01.410M42	M42	410
ZE01.430M42	M42	430
ZE01.510M42	M42	510
ZE01.520M42	M42	520
ZE01.530M42	M42	530
ZE01.630M42	M42	630
ZE01.640M42	M42	640

Other dimensions available on request

TURNBLADES "CENTROLOCK"

ART. ZE 02

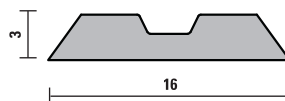

- Antioxidant treatment on knife body
- Polished cutting face for an excellent finish quality
- HS 18% for medium hard wood
- HW for very hard wood and abrasive materials

Item	Quality	L
ZE02.020HS	HS	20
ZE02.080HS	HS	80
ZE02.150HS	HS	150
ZE02.210HS	HS	210
ZE02.240HS	HS	240
ZE02.300HS	HS	300
ZE02.360HS	HS	360
ZE02.460HS	HS	460
ZE02.020HW	HW	20
ZE02.110HW	HW	110
ZE02.160HW	HW	160
ZE02.200HW	HW	200
ZE02.220HW	HW	220
ZE02.250HW	HW	250
ZE02.275HW	HW	275
ZE02.280HW	HW	280
ZE02.350HW	HW	350
ZE02.450HW	HW	450

TURNBLADES "CENTROFIX - QUICKFIX" - "CENTROSTAR"

ART. ZE 03

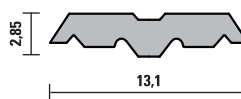

- Antioxidant treatment on knife body
- Polished cutting face for an excellent finish quality
- HS 18% for medium hard wood
- HW for very hard wood and abrasive materials

Item	Quality	L
ZE03.130HS	HS	130
ZE03.150HS	HS	150
ZE03.180HS	HS	180
ZE03.210HS	HS	210
ZE03.230HS	HS	230
ZE03.310HS	HS	310
ZE03.410HS	HS	410
ZE03.430HS	HS	430
ZE03.510HS	HS	510
ZE03.520HS	HS	520
ZE03.530HS	HS	530
ZE03.630HS	HS	630
ZE03.640HS	HS	640
ZE03.930HS	HS	930
ZE03.130HW	HW	130
ZE03.180HW	HW	180
ZE03.230HW	HW	230
ZE03.310HW	HW	310
ZE03.410HW	HW	410
ZE03.430HW	HW	430
ZE03.510HW	HW	510
ZE03.520HW	HW	520
ZE03.630HW	HW	630
ZE03.640HW	HW	640
ZE03.650HW	HW	650

Other dimensions available on request

TURNBLADES "TERMINUS"

ART. ZE 04

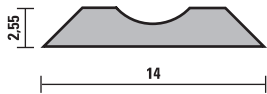

- Antioxidant treatment on knife body
- Polished cutting face for an excellent finish quality
- HS 18% for medium hard wood
- HW for very hard wood and abrasive materials

Item	Quality	L
ZE04.130HS	HS	130
ZE04.180HS	HS	180
ZE04.210HS	HS	210
ZE04.230HS	HS	230
ZE04.310HS	HS	310
ZE04.520HS	HS	520
ZE04.650HS	HS	650
ZE04.130HW	HW	130
ZE04.180HW	HW	180
ZE04.210HW	HW	210
ZE04.230HW	HW	230
ZE04.310HW	HW	310
ZE04.520HW	HW	520
ZE04.650HW	HW	650

Other dimensions available on request

TURNBLADES "BULLDOZER"

ART. ZE 05

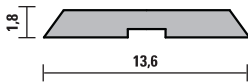

- Antioxidant treatment on knife body
- Polished cutting face for an excellent finish quality
- HW for very hard wood and abrasive materials

Item	Quality	L
ZE05.100HW	HW	100
ZE05.130HW	HW	130
ZE05.150HW	HW	150
ZE05.210HW	HW	210
ZE05.230HW	HW	230
ZE05.265HW	HW	265

Other dimensions available on request

TURNBLADES "ENSHIN"

ART. ZE 06

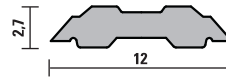

- Antioxidant treatment on knife body
- Polished cutting face for an excellent finish quality
- HS 18% for medium hard wood
- HW for very hard wood and abrasive materials

Item	Quality	L
ZE06.080HS	HS	80
ZE06.130HS	HS	130
ZE06.150HS	HS	150
ZE06.210HS	HS	210
ZE06.240HS	HS	240
ZE06.080HW	HW	80
ZE06.130HW	HW	130
ZE06.150HW	HW	150
ZE06.210HW	HW	210
ZE06.240HW	HW	240
ZE06.640HW	HW	640

Other dimensions available on request

TURNBLADES "SINUS"

ART. ZE 07

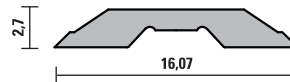

- Antioxidant treatment on knife body
- Polished cutting face for an excellent finish quality
- HS 18% for medium hard wood
- HW for very hard wood and abrasive materials

Item	Quality	L
ZE07.080HS	HS	80
ZE07.130HS	HS	130
ZE07.180HS	HS	180
ZE07.210HS	HS	210
ZE07.250HS	HS	250
ZE07.310HS	HS	310
ZE07.430HS	HS	430
ZE07.510HS	HS	510
ZE07.630HS	HS	630
ZE07.1050HS	HS	1050
ZE07.080HW	HW	80
ZE07.130HW	HW	130
ZE07.180HW	HW	180
ZE07.210.HW	HW	210
ZE07.250HW	HW	250
ZE07.310HW	HW	310
ZE07.430HW	HW	430
ZE07.510HW	HW	510
ZE07.630HW	HW	630

Other dimensions available on request

TURNBLADES "VARIPLAN"

ART. ZE 08

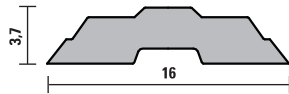

- Antioxidant treatment on knife body
- Polished cutting face for an excellent finish quality
- HS 18% for medium hard wood
- HW for very hard wood and abrasive materials

Item	Quality	L
ZE08.050HS	HS	50
ZE08.100HS	HS	100
ZE08.130HS	HS	130
ZE08.180HS	HS	180
ZE08.210HS	HS	210
ZE08.410HS	HS	410
ZE08.430HS	HS	430
ZE08.510HS	HS	510
ZE08.600HS	HS	600
ZE08.630HS	HS	630
ZE08.050HW	HW	50
ZE08.100HW	HW	100
ZE08.130HW	HW	130
ZE08.180HW	HW	180
ZE08.210HW	HW	210
ZE08.410HW	HW	410
ZE08.430HW	HW	430
ZE08.510HW	HW	510
ZE08.600HW	HW	600
ZE08.630HW	HW	630

Other dimensions available on request

TURNBLADES "BRÜCK"

ART. ZE 09

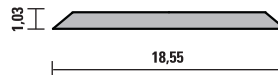

- Antioxidant treatment on knife body
- Polished cutting face for an excellent finish quality
- HS 18% for medium hard wood
- HSCo (cobalt) for very hard wood and abrasive materials

Item	Quality	L
ZE09.060HS	HS	60
ZE09.100HS	HS	100
ZE09.130HS	HS	130
ZE09.180HS	HS	180
ZE09.210HS	HS	210
ZE09.250HS	HS	250
ZE09.310HS	HS	310
ZE09.400HS	HS	400
ZE09.450HS	HS	450
ZE09.510HS	HS	510
ZE09.630HS	HS	630
ZE09.810HS	HS	810
ZE09.060HSCO	HSCo	60
ZE09.100HSCO	HSCo	100
ZE09.130HSCO	HSCo	130
ZE09.180HSCO	HSCo	180
ZE09.210HSCO	HSCo	210
ZE09.250HSCO	HSCo	250
ZE09.310HSCO	HSCo	310
ZE09.400HSCO	HSCo	400
ZE09.450HSCO	HSCo	450
ZE09.510HSCO	HSCo	510
ZE09.630HSCO	HSCo	630
ZE09.810HSCO	HSCo	810

Other dimensions available on request

TURNBLADES "ESTA"

ART. ZE 10

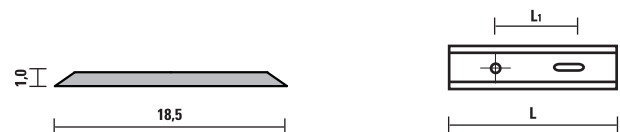

- Antioxidant treatment on knife body
- Polished cutting face for an excellent finish quality
- HS 18% for medium hard wood

Item	Quality	L	L1	n. holes	n. slots
ZE10.060HS NEW	HS	60	45	1	1
ZE10.100HS NEW	HS	100	45	1	1
ZE10.130HS NEW	HS	130	45	1	2
ZE10.200HS NEW	HS	200	45	1	2
ZE10.300HS NEW	HS	300	100	1	2
ZE10.400HS NEW	HS	400	100	2	3
ZE10.500HS NEW	HS	500	100	1	4
ZE10.650HS NEW	HS	650	200	1	3
ZE10.810HS NEW	HS	810	200	1	3

Other dimensions available on request

Sawblades

12



HW SAWBLADES FOR PORTABLE MACHINES
Page 12.12



HW SAWBLADES FOR PORTABLE MACHINES
Page 12.13



HW SAWBLADES FOR PORTABLE MACHINES
Page 12.13



HW GROOVING CUTTER FOR "LAMELLO"
Page 12.13



HW MULTI PURPOSE CIRCULAR SAWBLADES
Page 12.14



HW TRIMMING FINISHING
Page 12.15



HW MULTI PURPOSE SAWBLADES (thin kerf)
Page 12.16



HW MULTI PURPOSE CIRCULAR SAWBLADES
Page 12.16



HW MULTI PURPOSE CIRCULAR SAWBLADES
Page 12.17



HW RADIAL ARM SAWBLADES
Page 12.17



HW TRIMMING AND SIZING SAWBLADES
Page 12.18



HW TRIMMING AND SIZING SAWBLADES
Page 12.18



HW MULTIRIP SAWBLADES WITHOUT RAKERS
Page 12.19



HW SHOULDER RIP SAWBLADES WITH RAKERS
Page 12.19



HW MULTIRIP SAWBLADES WITH RAKERS
Page 12.20



HW MULTIRIP SAWBLADES WITH RAKERS (THIN KERF)
Page 12.20



HW CONICAL SCORING SAWBLADES
Page 12.27



HW ADJUSTABLE SCORING SAWBLADES
Page 12.28

Klein®



12



• **HW PANEL SIZING SAWBLADES**
• Page 12.28



• **HW PANEL SIZING SAWBLADES**
• Page 12.29



• **HW SCORING SAWBLADES FOR EDGE BANDING AND SQUARING MACHINES**
• Page 12.30



• **HW SCORING SAWBLADES FOR EDGE BANDING AND SQUARING MACHINES**
• Page 12.30



• **HW SAWBLADES FOR BUILDING SITES**
• Page 12.31



• **HW SAWBLADES FOR BUILDING SITES WITH COATING**
• Page 12.31



• **HW SAWBLADES FOR ALUMINIUM**
• Page 12.32



• **HW SAWBLADES FOR ALUMINIUM**
• Page 12.32



• **HW GROOVING SAWBLADES**
• Page 12.33



• **HW "DRY" OR "QUATTRO" SAWBLADES**
• Page 12.33



• **HW SAWBLADES FOR "SOLID SURFACE"**
• Page 12.34



• **HW SAWBLADES FOR PVC AND PLEXIGLASS**
• Page 12.34



• **HW SAWBLADES FOR FRAMES**
• Page 12.34



• **HW SAWBLADES FOR "SANDWICH" PANELS**
• Page 12.34



• **HW DM05 SAWBLADES FOR FERROUS MATERIALS**
• Page 12.35



• **DP SAWBLADES**
• Page 12.35



• **DP CONICAL SCORING SAWBLADES**
• Page 12.36



• **DP PANEL SIZING SAWBLADES**
• Page 12.36



• **REDUCTION RINGS FOR SAWBLADES**
• Page 12.37

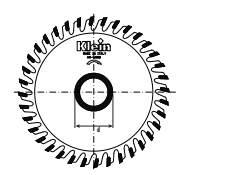

• **SPECIAL SAWBLADE REBORING**
• Page 12.37

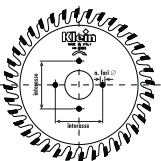

• **SAFETY PIN HOLES FOR SAWBLADES**
• Page 12.37

T.C.T. SAWBLADES

Klein sawblades are high quality products, guaranteed by the choice of raw materials developed in collaboration with leading European manufacturers of steel and carbide (i. e. our carbide tips are produced by Ceratizit). Throughout the production cycle, controls are followed extremely scrupulous and final acceptance ensures that all the characteristics of the blades Klein are meeting the highest standards of quality. At the end the production lots are numbered and filed.

The sawblades **Klein** are exclusively worked with laser cutting. Bores and keyways are honed to ensure maximum precision (h7). Without this process there will be a visible mark on the bore edge.

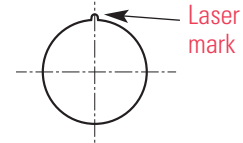
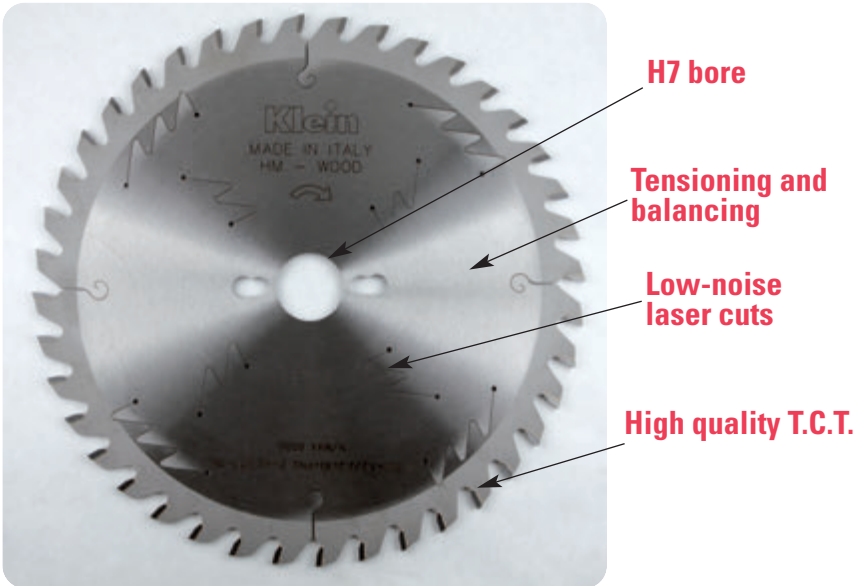

Tensioning and balancing are operated with completely automatic machines, which assure the absence of vibrations and higher quality results.

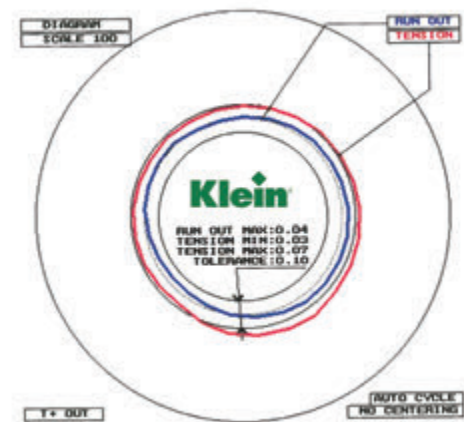

Low noise sawblades

According to the latest technical tests, our saw blades are manufactured with an advanced system of noise reduction guaranteed by an attentive position of the laser ornaments, different for each diameter (🎵).

The body of the saw blade remains solid and perfectly tensioned while sound waves generated during the working process are absorbed either longitudinally or crosswise.

The laser ornaments in the sizing saw blades (Items HBS/HCS) and for aluminium working (Items LA/LB) are filled up with a special soundproofing resin (🎵), resistant to ultrasound and high temperatures. Considerably lowering the vibrations, the tool can work longer and perform a better finish cut, also after its resharpening.

Quality of tungsten carbide used:

Quality	Composition	Grain size	Bending strength	Hardness	Density	Toughness	Wear resistance
KCR05 ISO: K01 USA: C4	Co+Ni 2,76%	Ultrafine grain 0,2-0,5 µm	2500 MPa 363.000 P.S.I.	2150 HV10 2110 HV30 94,4 HRA	15,20 g/cm³	6,0 MPa.m ^{-1/2}	0 1 2 3 4 5 6 7 8 9 10 [Progressive bar chart]
KCR06 ISO: K01 USA: C4	Co+Ni 3,0%	Micrograin 0,5-0,8 µm	2300 MPa 334.000 P.S.I.	1950 HV10 1910 HV30 93,6 HRA	15,25 g/cm³	8,5 MPa.m ^{-1/2}	0 1 2 3 4 5 6 7 8 9 10 [Progressive bar chart]
HC10 ISO: K10 USA: C3	Co 5,6%	Fine grain 0,8-1,3 µm	2150 MPa 334.000 P.S.I.	1760 HV10 1730 HV30 92,7 HRA	15,00 g/cm³	9,2 MPa.m ^{-1/2}	0 1 2 3 4 5 6 7 8 9 10 [Progressive bar chart]
HC20 ISO: K20 USA: C2-C3	Co 6,0%	Fine grain 0,8-1,3 µm	2200 MPa 334.000 P.S.I.	1640 HV10 1620 HV30 92,1 HRA	15,00 g/cm³	9,9 MPa.m ^{-1/2}	0 1 2 3 4 5 6 7 8 9 10 [Progressive bar chart]
SMX ISO: P20-P25 USA: C6	Co 10,5%	Fine grain 0,8-1,3 µm	2200 MPa 316.000 P.S.I.	1550 HV10 1530 HV30 91,5 HRA	12,65 g/cm³	10,0 MPa.m ^{-1/2}	0 1 2 3 4 5 6 7 8 9 10 [Progressive bar chart]

Diagram for determining cutting speed:

Diagram shows the cutting speed in m/sec, defined RPM and sawblades diameter.

V_t = cutting speed (m/sec)
D = sawblades diameter (mm)
n = RPM

$$V_t = \frac{D \times \pi \times n}{60 \times 1.000}$$

D=mm \ RPM	RPM																
	1500	2000	2500	2800	3000	3500	4000	4500	5000	5600	6000	8000	9000	10000	12000	18000	
80	6,5	8,5	10,5	12	13	14	15	19,1	21	23,5	26	34	38	42	52	76	
90	7	9,5	12	13,5	14	16	17	21	24	26,5	28	38	42	48	56	84	
100	8	10	13	15	16	18	21	24	26	29	31	41	47	52	63	96	
120	9,5	13	16	18	19	22	25	28	31	35	38	49	57	63	65		
125	10	14	16,5	20	19,5	24	27	31	34	36,5	41	53	61	68	82		
140	11	15	18	21	22	26	29	33	37	41	44	57	66	73	88		
150	12	16	19,5	22	23,5	27	31	35	39	44	47	63	71	79	94		
160	13	17	21	24	26	29	33	38	42	47	50	65	75	84			
180	14	19	24	27	28	33	42	42	47	53	57	73	85	94			
200	16	21	26	29	32	37	42	47	52	58,5	63	81	94				
225	17	23	30	32	36	40	46	52	58	66	69	92	104				
250	20	26	33	37	40	46	52	59	65	73,5	79						
300	24	31	40	44	48	55	63	71	79	88	94						
350	27	37	47	51	56	64	73	83	92	105							
400	31	42	54	59	64	73	83	92	105								
450	35	47	59	66	70,5	83	94	105									
500	39	52	67	73	80	92											

- Mineral fibreplates
- Wood-based material, plastic material and non-ferrous metal
- **Hardwood**
- **Softwood**
- **Safety limit**

Recommended cutting speed:

CUTTING MATERIAL		Cutting speed (mm/s)	Feed rate (mm/z)
Softwood	Cutting along grain	58÷100	0,5÷3,0
	Cutting across grain	60÷100	0,2÷0,4
Hardwood	Cutting along grain	61÷100	0,3÷1,0
	Cutting across grain	65÷100	0,2÷0,8
Exotic timber	Cutting along grain	58÷100	0,3÷1,0
Plywood		55÷80	0,1÷0,2
Particle board		60÷85	0,3
HDF		60÷80	0,1÷0,3
MDF		60÷80	0,1÷0,3
Playwood boards, veneered or coated on both sides		60÷100	0,2
Laminated boards		55÷80	0,1-0,25
Melamine		58÷80	0,15
Thermoplastic		50÷75	0,05-0,1
Duroplastic		30÷60	0,02-0,05
Aluminium profiles		35÷70	0,005-0,08

Pin holes as per following details:

Scale 1:1

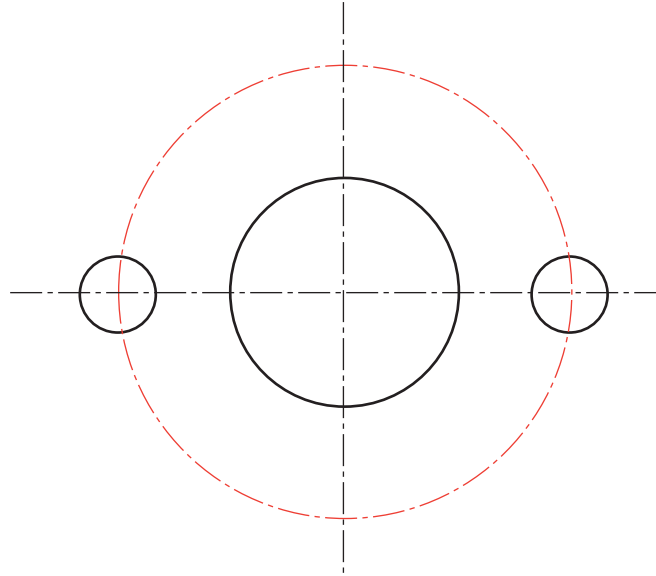

PH01

Name	Nr of holes/diameter of holes/pitch circle diameter
PH01	2/10/60

Scale 1:1

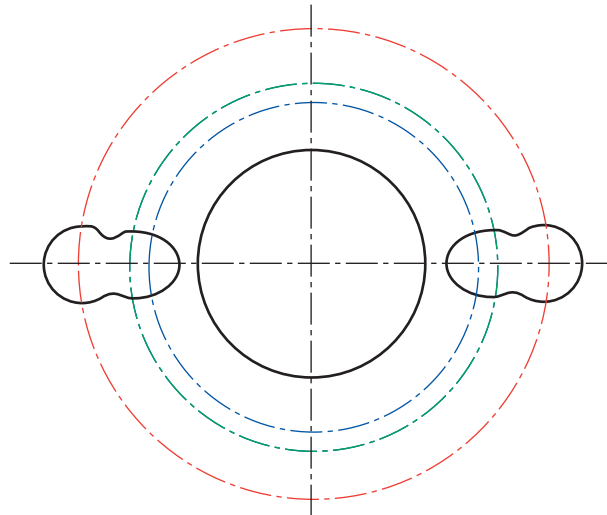

PH02

Name	Nr of holes/diameter of holes/pitch circle diameter	Machine type
PH02	2/7/42 + 2/9,5/46,5 + 2/10/60	Universal

Instructions for a correct use of sawblades:

- 1- Be sure the spindle where the sawblade has to be mounted is clean and balanced;
- 2- Be sure the sawblade is perfectly aligned with the working table;
- 3- Be sure the working parameters (feed rate, cutting speed, etc.) are correct;
- 4- Never exceed the RPM indicated on the sawblade, otherwise it can be dangerous for the operator;
- 5- Check time to time the state of the cutting tips and, in case, let the sawblade professionally resharpened;
- 6- When processing thicker material, reduce the number of teeth;

Reference table for the choice of the right saw blade (X= sufficient - XX= good - XXX= excellent) **Information just as a guide**

Item	Natural woods						Pressed woods		Board materials			Paper and mineral fiber
	SOFTWOOD (cider, poplar, pine)		HARDWOOD (ash, walnut, teak)		EXOTIC TIMBER		PLYWOOD	PARTIAL BOARD	BLOCK BOARD	VENEERED	LAMINATED	
	Rip cut	Cross cut	Rip cut	Cross cut	Rip cut	Cross cut						
Art. AA - Page 12.12	XXX	XXX	XXX	XXX	XX	XX	X	X	XX	XX	X	
Art. AB - Page 12.13												
Art. AL - Page 12.13												
Art. CA - Page 12.14	X	XX	X	XX	X	X	XX	XXX	X			
Art. CB - Page 12.14	XXX	XX	XXX	XX	XX	XX	X	XXX	XX	XX	X	XXX
Art. CC - Page 12.14	XX	XX	XXX	XXX	X	XX	XX	XXX	XX	XX	X	X
Art. CD - Page 12.15	XXX	XX	XXX	XXX	X	XXX	XX	XXX	XXX	XX	XX	
Art. CE - Page 12.15	X	XX	XXX	XXX	XXX	XXX	XXX	XXX	X	XX	XX	
Art. CF - Page 12.16	X	X	X	XX	XX	XX			X	XX	XXX	
Art. CG - Page 12.16	XX	XXX	XX	XXX	XX	XXX	XXX	XXX	X	XX	XX	X
Art. CH - Page 12.16	XX	XXX	XX	XXX	XX	XXX	XXX	XXX	X	XX	XX	XXX
Art. DA - Page 12.16	XXX	X	XXX	X			X	X				
Art. DC - Page 12.17	XXX	XX	XXX	XX	XXX	X	XX	X	XX	XX	XX	
Art. FAS - Page 12.17		XX		XX		X					X	
Art. FB - Page 12.18							XXX	XX	XX	XXX	XXX	
Art. FCS - Page 12.18							XX	XXX	XXX	XXX	XXX	
Art. FE - Page 12.19	XXX	XX	XX	XX	XX	XX	X	X				
Art. FG - Page 12.19	XXX	XX	XXX	XX	XX	XX	X	X				
Art. FH - Page 12.20	XXX	XX	XXX	XX	XX	XX	X	X				
Art. FK - Page 12.20	XXX	XX	XXX	XX	XX	XX	X	X				
Art. FI - Page 12.27							XX	XXX	XXX	XXX	XXX	
Art. FL - Page 12.28							XX	XXX	XXX	XXX	XXX	
Art. FM - Page 12.30							XX	XXX	XXX	XXX	XXX	
Art. FP - Page 12.30							XX	XXX	XXX	XXX	XXX	
Art. GA - Page 12.31	XXX	XX	XXX	XX	X	X						
Art. HBS - Page 12.28							X	XX	XX	XX	XX	
Art. HCS - Page 12.29							XXX	XXX	XXX	XXX	XXX	
Art. KA - Page 12.33	XXX	XXX	XXX	XX	XXX	XX	XX					
Art. LA - Page 12.32												
Art. LB - Page 12.32												
Art. LZ - Page 12.33	X	X	XX	XX	X	X	X	X				
Art. MES - Page 12.34												
Art. MGS - Page 12.34												
A. MLS/MMS - P. 12.34	XXX	XXX	XXX	XXX	XX	XX	XX	XX	X	XX	XX	
Art. MP - Page 12.34												
Art. PA - Page 12.35												
Art. PB - Page 12.35												
Art. XFC - Page 12.35	X	X	XX	XX	XXX	XXX	XXX	XXX	XXX	XX	XX	
Art. XFI - Page 12.36	X	X	XX	XX	XXX	XXX	XXX	XXX	XXX	XX	XX	
Art. XHC - Page 12.36	X	X	XX	XX	XXX	XXX	XXX	XXX	XXX	XX	XX	

Reference table for the choice of the right saw blade (X= sufficient - XX= good - XXX= excellent) **Information just as a guide**









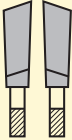
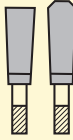

Item	Panels			Plastic materials			Sandwich	Non-ferrous materials			Ferrous materials	
	FIBER		PLASTIC COATED	THERMOPLASTIC	DUROPLASTICS	WITH PLASTIC BINDERS		ALUMINIUM PROFILES	ALLUMINIUM	ALUMINIUM ALOYS	PROFILES	SOLID
	HDF	MDF										
Art. AA - Page 12.12												
Art. AB - Page 12.13				XXX	XX	XX		XX	XX	XX		
Art. AL - Page 12.13				XX	XX	XX		XXX	XX	XX		
Art. CA - Page 12.14		X										
Art. CB - Page 12.14	X	X										
Art. CC - Page 12.14	X	X										
Art. CD - Page 12.15	X	X										
Art. CE - Page 12.15	XX	XX		XXX	XX	X						
Art. CF - Page 12.16		XX										
Art. CG - Page 12.16	X	XX	X	XX	XX	XX						
Art. CH - Page 12.16				XXX	XX	XX						
Art. DA - Page 12.16												
Art. DC - Page 12.17		X		X								
Art. FAS - Page 12.17			XXX			X						
Art. FB - Page 12.18	XX	XX	XXX	XXX	XXX	X						
Art. FCS - Page 12.18	XX	XXX	XX	XX	XX	X	X					
Art. FE - Page 12.19												
Art. FG - Page 12.19												
Art. FH - Page 12.20												
Art. FK - Page 12.20												
Art. FI - Page 12.27	XXX	XXX	XXX									
Art. FL - Page 12.28	XXX	XXX	XXX									
Art. FM - Page 12.30	XXX	XXX	XXX									
Art. FP - Page 12.30	XX	XX	XXX	X	X	XX						
Art. GA - Page 12.31												
Art. HBS - Page 12.28	XX	XX	X									
Art. HCS - Page 12.29	XXX	XXX	XXX	X	XXX	X						
Art. KA - Page 12.33												
Art. LA - Page 12.32								XX	XXX	XXX		
Art. LB - Page 12.32								XXX	XX	XX		XX
Art. LZ - Page 12.33				X	X	X		XX	XX	XX	XXX	
Art. MES - Page 12.34				X	XXX	XX						
Art. MGS - Page 12.34				XX	XXX	X						
A.MLS/MMS - P. 12.34	XX	XXX	XX							XX		
Art. MP - Page 12.34							XXX					
Art. PA - Page 12.35											XXX	XXX
Art. PB - Page 12.35											XXX	XXX
Art. XFC - Page 12.35	XXX	XXX	XXX	X	X			X	X	X		
Art. XFI - Page 12.36	XXX	XXX	XX	X	X			X	X	X		
Art. XHC - Page 12.36	XXX	XXX	XX	X	X			X	X	X		

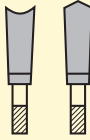
Number of teeth suggested:

Calculation of the number of teeth, given the diameter of the saw blade and the thickness of the material to be worked.

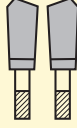
$$Z \text{ (nr. teet)} = \frac{D \text{ (diameter/mm)} \times K}{Sp \text{ (thickness/mm)}}$$

K = 7 for ripcutting on natural wood
K = 9 for ripping or crosscutting
K = 11 for crosscutting of hard woods and hard materials

 <p>WZ: alternate top bevel teeth, suitable for soft and hardwood, fibre materials, MDF. Especially clean cuts.</p>	 <p>FZ/TR: triple chip teeth form, suitable for solid wood, plastic coated materials, non ferrous profiles, hardwood.</p>	 <p>FZ: flat teeth, suitable for cutting along grain on large cutting height soft and hardwood.</p>	 <p>HZ/DZ: Hollow tooth/inverted V-tooth, suitable for saw benches on plastic coated chipboards and fibre materials.</p>
 <p>FZ/FA: Flat tooth with bevel, with chip limiter, for cutting timber, also in presence of concrete or metal remains, nails, etc.</p>	 <p>LFZ: flat teeth with chip limiter, suitable for table saws. For cutting along and across grain in wooden boarding materials.</p>	 <p>KON/FZ: conical tooth, used on scoring blades</p>	 <p>WZ/FA: alternate top bevel teeth, suitable for soft and hardwood, fibre materials, MDF. Especially clean cuts.</p>
 <p>TR: trapezoidal tooth, used on saw blades "dry" (Item LZ).</p>	 <p>ES: (ES-L/ES-R) One-sided top bevel tooth (right or left), used on edge banding machines or hogging units.</p>	 <p>BW: special tooth shape for item "PB" (steel blade, for cutting metals).</p>	 <p>C: special tooth shape for item "PA" (steel blade, for cutting metals).</p>

Klein saw blades for portable machines are delivered in hanging packaging while those for industrial machines in a very robust carton packaging.

PACKAGING SAW BLADES FOR PORTABLE MACHINES

PACKAGING SAW BLADES FOR INDUSTRIAL MACHINES



Sawblades
 Ø127÷Ø140
 Ø150÷Ø180
 Ø200÷Ø240

Dimensions
 165x179x5
 215x234x5
 254x277x5

Sawblades
 Ø80÷Ø150
 Ø160÷Ø210
 Ø220÷Ø250
 Ø280÷Ø300
 Ø320÷Ø400
 Ø420÷Ø500
 Ø550÷Ø600

Dimensions
 183x190x10
 223x223x15
 327x377x15
 372x377x15
 469x472x15
 551x550x25
 665x670x25

Symbols:

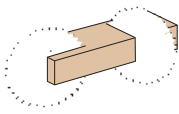

Art. AA - CB - CA - CF
DC - KA - LZ
XFC - XFI - XHC

For cutting along and across grain of softwood

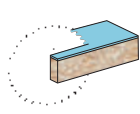

Art. CD - CE - CF
DC

For cutting single side laminate board

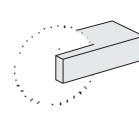

Art. LB

For cutting aluminium

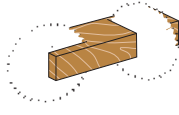

Art. AA - CB - CC
DC - KA - LZ
XFC - XFI - XHC

For cutting along and across grain of hardwood

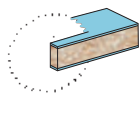

Art. FB - FCS - FM
FP - HBS - HCS
MMS - XFC
XHC - XFI

For cutting double side laminate board

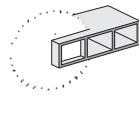

Art. AL - LA - LZ

For cutting aluminium profiles

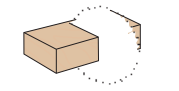

Art. FAS

For cutting across grain of softwood

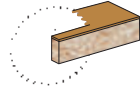

Art. AA - CB - CC
CD - CE - CG
CH - DC

For cutting single side veneer board

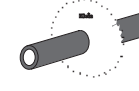

Art. LZ - PA - PB

For cutting steel and ferrous materials

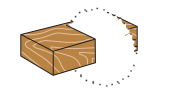

Art. CD - CE
CG - FAS

For cutting across grain of hardwood

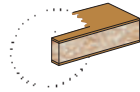

Art. FB - FCS - FI
FM - FP - HBS
HCS - XFC
XFI - XHC

For cutting double side veneer board

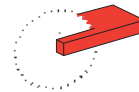

Art. LA - LB

For cutting PVC



Art. DA - FE - FG
FH - FK

For cutting along grain of softwood

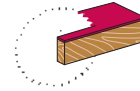

Art. FAS - FCS - FP

For cutting plastic coated materials

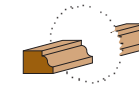

Art. MLS

For cutting wood frames

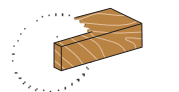

Art. CA - DA - FE
FG - FH - FK

For cutting along grain of hardwood

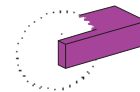

Art. MES

For cutting CORIAN®

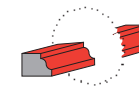

Art. MLS

For cutting PVC frames

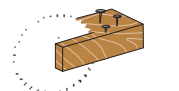

Art. AB - AL
GA - GB

For cutting wood for construction with small metal parts

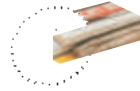

Art. GA - GB

For working on building sites

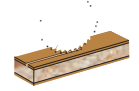

Art. FI - FL

Scoring sawblades for cutting veneer board



Art. CE - CG - FCS
FM - FP
HBS - HCS
XFC - XFI - XHC

For cutting MDF

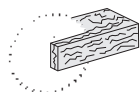

Art. CB - CC - CH

For cutting paper coated materials

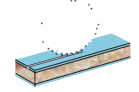

Art. FI - FL

Scoring sawblades for cutting laminate materials

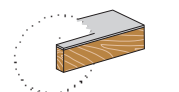

Art. FAS

For cutting aluminium wood profiles

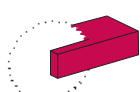

Art. AB - AL
FB - LZ
MES - MGS

For cutting plastic materials

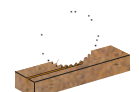

Art. FI - FL

Scoring sawblades for cutting MDF

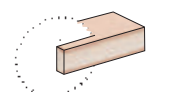

Art. MP

For cutting "Sandwich" panels

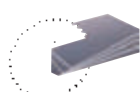

Art. CH - MES - MGS

For cutting plexiglass

REFERENCE TABLE FOR PORTABLE MACHINES

Diameter	Producer	Model
125 x 12,7	B & D	DN55, DN56, D985, D984, DN254
127 x 12,7	B & D	DN55, DN56, D985, D984, DN254
130 x 16	Bosch Metabo	PKS240, PKS40 S, S43 BHK01, KS3340 S, 4340, 6311, BHK2, MaxKS40 S
134 x 20	AEG Holz-Her Peugeot	TKS42 2110, 2111, 2171, Mosquito S SC42 C
140 x 12,7	B & D	DN227, DN227 H, BD227, BD846, BD 228
140 x 16	Makita	5000SBR, 500, 5000GB, N500
140 x 20	Bosch Holz-Her Metabo AEG Peugeot Stayer	1551, 1559 2260, 2270, 170, 260, 270 BTK, C1, C2, BTKO HK 40 SC47 C, HKS 700, Profiline, SC 1 Profiline, CP 46
150 x 13	Kress Mafell Skil	6006, 6018, 9060, HKS400, 6000, 6010 Biberella 533, 553
150 x 16	Bosch Scheer/Ryobi Skil	PKS46, S33, S1, GKS12V, GB1923 (England) MS 50 52465
150 x 20	AEG B & D Casals De Walt Felisatti Metabo Perles Stayer Peugeot Hitachi Fein Skil Elu Scheer/Ryobi Makita	HK45A, HK50, HK52, HKS52, HK737 HK46S, AHK52, HK46N, HK46, HK45 P88.09 BSC150, VSC50 DW 351 TP 751 4341S, KS52 S, KS0846, BTK0, 62, 61, KS0846 S, KS0852 S, KSE0946 S KS50 CP50 SC53 C, SC52, SC52 C, SC46 C5, FC5, FC5 SA SSK646 1850H, 1850 MH151 MS45, 45E, MS45-3 5600 B
150 x 30	Festo Elu	AXF45, AF45 E MH18
156 x 12,7	B & D	DN228, DN57, SR352E, BD228, P36-01, BD228L, BD228CK, SR352

Use reduction rings Art. ZA page 10.14
to have different bores in your sawblades

REFERENCE TABLE FOR PORTABLE MACHINES

Diameter	Producer	Model
160 x 16	B & D Bosch Peugeot Rockwell Ryobi Scheer Skil Ulmia	M336, M975, M976, BD855 PKS54, GKS54CE, PKS54CE, GKS54 SC4510XA 63416 W5502 C FM 534, 536, 552B, 416H, 1409H, 1408H, 552H, 1855H, 367, 856, 1410H 1607, 1610
160 x 20	AEG Atlas Copco Festool Haffner Hitachi Mafell Makita Metabo Kress Holz-Her Ryobi Fein Festo Protool Techline Tip Valex	HK55A, HK55B, HK160A, HK160B K55S, K55SE T555 KSU50 FC65A, C6DA X55, XE55, PS52, MKS55, MS55, A55, B55, FU50 5600NB, 5600 DW KS1155S 6050, 6055 Duo, 1050KS HKU50, HKU264, 1420, 2103, 2104, 2105, 2106 W-560 (P), W5502 SSK660 ATF55E, ATF55, AP55E, AP55, AP55E-FS CSP55 EHS 160 HKS 160 SC 160
160 x 30	Festo Mafell	AU50, AUP50, AAU KS320
165 x 20	Festo	5603R
170 x 20	Makita Mafell	5600 BR B55, FK50, A55, FUS50
170 x 30	Elu Festo Holz-Her Haffner Bosch Hitachi	MH 155, MH55, MH 65 AM42S+A, AMT42S, AXT55, AT55E, AXT50LA 2115(t55A), 2266, 2271, 2281, 281, HKUS266 KSU110 1552, 1556, 1563, GKS55 PSU6, C-6SA
180 x 20	Makita Haffner Peugeot Metabo Ryobi B & D	SR1800, 5800B, 5801 B, 5800, 5800N, S800BR KSU60, SKU113 FIP50S 6317S W-66N, W-651A, W-6502 HS1200, HD2062
180 x 30	Elu Bosch Festo Holz-Her Haffner	MH65 0550, 1560, 1557, 1550, 1553 AU60S, AU55S, AU60P, AUT60S, AUT42S 2112, HKU55, HKU2272, HKU2291, 2113, 2292, 2282, 2269 KSU113

Use reduction rings Art. ZA page 10.14
to have different bores in your sawblades

REFERENCE TABLE FOR PORTABLE MACHINES

Diameter	Producer	Model
184 x 16	B & D	HD1000, DN59, DN229, DN820
		SR300, P37-03, P37-05, GD60,
		HD1200P, HD2062, SEC718, SR362E
	Skil	BD229, BD865E
		1865U, 77, 77U, 537, 553B, 553H,
	559, 559U, 574U, 857, 1865H	
Wolf	6070	
Peugeot	SC66C, SC650, 10XA, SC65C	
Rockwell	315, 4500, 63417	
190 x 16	Bosch	PKS65, P300, P30
	Skil	1865U, 1965U, 1865H
190 x 20	Makita	5800BR, 3501
	Kress	6060, CHKS6060, 1400KS, 1600KS,
		1600HTKS
	Metabo	KS4345S, 5348, KS4346S, KS65S,
Robert, BTK, KSE1668S		
190 x 30	AEG	HK65A, HK65, HKS65, HK190, HK66,
		HKS66, HKSE66, HKE66, HKS65A
	Atlas Copco	K66S, K66SE
	Holz-Her	2116(t-65a), 2117(t65i), 2127, 2119,
		2269(t65e), 2126, 2282, 2114, 2292, 2113
	Bosch	1553, 0051, 1564, PKS66, GKS66CE,
		GKS65, PKS66CE
	De walt	DW65, DW365
	Elu	MH165
	Hitachi	FC75A, PSM-7, PSU-7
	Felisatti	TP765, TP766
	Festo	AP65E, AP65E-FS, AT65E
	Mafell	MKS65
	Skil	1965U
Scheer	MS 65	
Makita	5703R	
200 x 16	B & D	M338
	Hanning	TK200, TK20S, TK20N, TK300
	Ulmia	1607, 1708
	Ryobi	W750
200 x 30	Festo	AU65S, AD65, AXP65, AXP200,
		AP68E, AP65S
	AEG	HK200, HK201
	Bosch	1561, 0551
	Haffner	AKS
	Mafell	B65, X72
	Holz-Her	2113, 2292, 2555
	Kity	0618
	Scheer	MS 70, FM16DNC,
		FM16Electronic, FM16Standard
	Makita	5700
	Ulmia	1706
	Valex	SC200
	210 x 25	Makita
Skil		1524H, 1873H, 1525, 1886, 1985, 1986

Use reduction rings Art. ZA page 10.14
to have different bores in your sawblades

REFERENCE TABLE FOR PORTABLE MACHINES

Diameter	Producer	Model
210 x 30	AEG	HK75A, HK75, HKS75
	Atlas Copco	HKS75
	Fein	SSK661
	Elu	MH82, MH182, MH30
	Casals	SC210, VSC70
	B & D	SEC818, DN800, DN810, PS174,
		SR700, P38.02, BD800, HD2075S
	Bosch	1554, 1588, 1565, GKS75S
	Haffner	RS75, KSU118
	Hitachi	PSU8, PSM8, C8U, C8FA
	Holz-Her	2264, 2267, 2284, PKS267, 2279
	Mafell	MKS75, MKS85S, MS75
	Perles	KS70
	Skil	1873H, 1524H
Metabo	KSE 1678, KG 1670	
216 x 30	De Walt	DW712, DW771, DW777
220 x 20	Flott	2000, KS3000
	Schleicher	Compact151
220 x 30	Festo	AU77S,
	Haffner	KL177, KL178, KSU118
	Holz-Her	PKS+HKU75, 274, 1205, 1331,
		1342, 1345, 1346, 2279
	Metabo	6322S
Scheer	MS80, M585	
225 x 30	Festo	CS70EB
230 x 30	Holz-Her	2218(t85i), 2120(t85e), 2293, 2294
	AEG	HKS85
	Atlas Copco	HKS85
	B & D	P39-02, SEC918, HD2086S
	Bosch	1562, 0052, 1566, GKS85S
	Casals	SC230
	Haffner	SP187, KS85, HUS85
	Skil	1886H
	Scheer	MS85
235 x 25	Makita	SR2300, 5900BR, 5900B, 5900
235 x 30	De Walt	DW383
	Haffner	KL176, KS85, KSU85, SP187
	B & D	P39-02, SEC 918
	Skil	1986
	Makita	5903R
	Hitachi	C9U, PSM9, PSU9
240 x 30	Festo	AXP85, AP85E, AP88E, AP85-E-TS
	Holz-Her	2268, HKD65
	Metabo	6323 S, KS1785S, KS6323S Automatic
	Elu	MH85
	Bosch	1555
	Mafell	B82, MKS85
	Hitachi	PSM-9, PSU-9
	AEG	HK240
	De Walt	DW86
305 x 30	De Walt	DW718, DWS780

Use reduction rings Art. ZA page 10.14
to have different bores in your sawblades

HW SAWBLADES FOR PORTABLE MACHINES

ART. AA

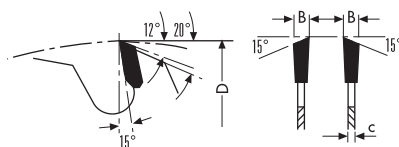

- Fine cut HW sawblades
- **WZ** alternate top bevel teeth
- For cutting along and across grain of **softwood, hardwood, exotic timber and veneer boards**
- High teeth number sawblades best finishing cut
- **HW grade: HC10 (K10-C3)**

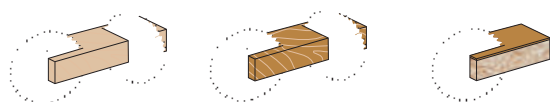

Item	D	d	B/c	Z	Pin holes
AA127.02014 <i>selling out</i>	127	12,7	2,6/1,8	20	
AA127.03613	125	12,7	2,6/1,6	36	
AA130.02016	130	16	2,6/1,6	20	
AA130.03616	130	16	2,6/1,6	36	
AA134.03620	134	20	2,6/1,6	36	
AA140.02013	140	12,7	2,6/1,6	20	
AA140.02016	140	16	2,6/1,6	20	
AA140.02020	140	20	2,6/1,6	20	
AA140.03020	140	20	2,6/1,6	30	
AA140.04213	140	12,7	2,6/1,6	42	
AA140.04216	140	16	2,6/1,6	42	
AA140.04220	140	20	2,6/1,6	42	
AA150.02016	150	16	2,6/1,6	24	
AA150.02020	150	20	2,6/1,6	24	
AA150.02030	150	30	2,6/1,6	24	
AA150.03016	150	16	2,6/1,6	40	
AA150.03020	150	20	2,6/1,6	40	
AA150.04820	150	20	2,6/1,6	48	
AA150.04830	150	30	2,6/1,6	48	
AA156.04813 <i>selling out</i>	156,5	12,7	2,6/1,8	48	
AA160.02416	160	16	2,6/1,6	24	2/6/32
AA160.02420	160	20	2,6/1,6	24	2/6/32
AA160.02430 NEW	160	30	2,6/1,6	24	2/7/42
AA160.03016	160	16	2,6/1,6	30	2/6/32
AA160.03020	160	20	2,6/1,6	30	2/6/32
AA160.03030 NEW	160	30	2,6/1,6	30	2/7/42
AA160.04816	160	16	2,6/1,6	48	2/6/32
AA160.04820	160	20	2,6/1,6	48	2/6/32
AA165.02420	165	20	2,6/1,8	24	
AA170.03030	170	30	2,6/1,6	30	2/7/42
AA170.05230	170	30	2,6/1,6	52	2/7/42

Item	D	d	B/c	Z	Pin holes
AA180.02420	180	20	2,6/1,6	24	2/6/32
AA180.02430	180	30	2,6/1,6	24	2/7/42
AA180.03020	180	20	2,6/1,6	40	2/6/32
AA180.03030	180	30	2,6/1,6	40	2/7/42
AA180.05620	180	20	2,6/1,6	56	2/6/32
AA180.05630	180	30	2,6/1,6	56	2/7/42
AA184.03016	184	16	2,6/1,6	30	
AA184.05616	184	16	2,6/1,6	56	
AA190.02416	190	16	2,6/1,6	24	2/6/32
AA190.02420	190	20	2,6/1,6	24	2/6/32
AA190.02430	190	30	2,6/1,6	24	2/7/42
AA190.03616	190	16	2,6/1,6	40	2/6/32
AA190.03620	190	20	2,6/1,6	40	2/6/32
AA190.03630	190	30	2,6/1,6	40	2/7/42
AA190.05616	190	16	2,6/1,6	56	2/6/32
AA190.05620	190	20	2,6/1,6	56	2/6/32
AA190.05630	190	30	2,6/1,6	56	2/7/42
AA200.02430	200	30	2,6/1,8	24	2/7/42
AA200.03630	200	30	2,6/1,8	36	2/7/42
AA200.06430	200	30	2,6/1,8	64	2/7/42
AA210.02430	210	30	2,8/1,8	24	2/7/42
AA210.03625 NEW	210	25	2,8/1,8	36	2/7/42
AA210.03630	210	30	2,8/1,8	36	2/7/42
AA210.06430	210	30	2,8/1,8	64	2/7/42
AA220.02430 <i>selling out</i>	220	30	2,6/1,8	24	
AA220.03630	220	30	2,8/1,8	36	2/7/42
AA220.06430	220	30	2,8/1,8	64	2/7/42
AA225.03430	225	30	2,6/1,8	34	2/7/42
AA230.02430	230	30	2,8/1,8	24	2/7/42
AA230.03630	230	30	2,8/1,8	36	2/7/42
AA230.06430	230	30	2,8/1,8	64	2/7/42
AA235.03625 NEW	235	25	2,8/1,8	36	2/7/42
AA235.03630	235	30	2,8/1,8	36	2/7/42
AA235.06430	235	30	2,8/1,8	64	2/7/42
AA240.03630	240	30	2,8/1,8	36	2/7/42
AA240.07230	240	30	2,8/1,8	72	2/7/42

BASE 1 modular panel

Small display, ideal for starting with a basic assortment
Dimensions (cm): 110 (L) x 90 (H) x 30 (P)



HW SAWBLADES FOR PORTABLE MACHINES

ART. AB

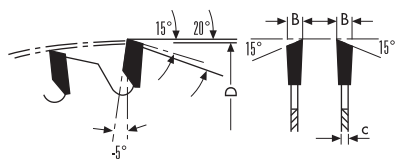

- Fine cut HW sawblades
- **WZ** alternate top bevel teeth
- For cutting **plastic materials** and **wood for construction with small metal parts**
- **5° negative** hook angle
- **HW grade: HC10 (K10-C3)**



Item	D	d	B/c	Z
AB216.02430	216	30	3,0/2,0	24
AB216.04830	216	30	3,0/2,0	48
AB216.06030	216	30	3,0/2,0	60
AB305.06030 NEW	305	30	3,2/2,2	60

HW SAWBLADES FOR PORTABLE MACHINES

ART. AL

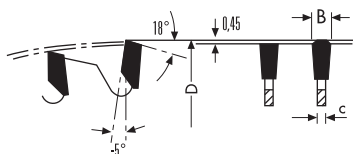

- Fine cut HW sawblades
- **FZ/TR** triple chip teeth
- For cutting **Alu-panels, laminated materials, plastics, solid surface** and **wood for construction with small metal parts**
- **5° negative** hook angle
- **HW grade: HC10 (K10-C3)**

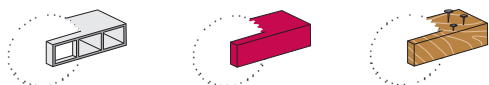

Item	D	d	B/c	Z
AL160.02416	160	16	2,6/1,6	40
AL160.02420	160	20	2,6/1,6	40
AL160.05620 NEW	160	20	2,2/1,6	56
AL180.02420	180	20	2,6/1,6	48
AL190.03020	190	20	2,6/1,6	54
AL190.03030	190	30	2,6/1,6	54
AL210.03430	210	30	2,6/1,6	54
AL216.06030	216	30	3,0/2,0	64
AL220.03430	220	30	3,0/2,0	64

HW GROOVING CUTTER FOR "LAMELLO"

ART. AH

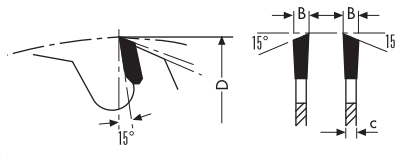

Grooving cutter for "Lamello"

- Fine cut HW sawblades
- **WZ** alternate top bevel teeth
- For **grooving of "lamello" joints**
- **HW grade: HC10 (K10-C3)**



Item	D	d	B/c	Z
AH100.10622	100	22	3,96/2,8	8
AH100.21222	100	22	3,96/2,8	12



"Lamello"-groove cutter

- For **grooving of "lamello" joints**
- Cutter with 2 teeth positive + 4 teeth negative for best finishing cut
- **HW grade: HC10 (K10-C3)**



Item	D	d	B/c	Z
AH100.20622	100	22	3,96/2,8	2 pos.+4 neg.

Cutter with reversible knives art. TAH100.20622 (page 13.22)

Surface joints



"T"-joints

HW MULTI PURPOSE CIRCULAR SAWBLADES

ART. CA - CB/CBS - CC/CCS

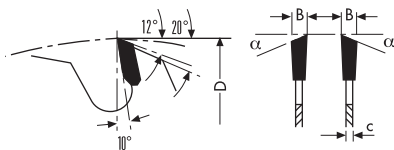

- WZ alternate top bevel teeth
- Suitable for table saws and panels saws
- Suitable for **particle board in stack**
- = no-noise
- HW grade: KCR06 (K01-C4)

Pin holes: PH01= 2/10/60 - PH02=2/7/42 + 2/9,5/46,5 + 2/10/60

ART. CA

- Suitable for ripping of **hardwood and plywood** for cutting across grain suitable for **softwood**

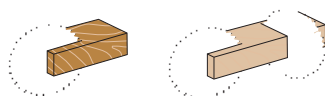

Item	D	d	B/c	Z	α	Pin holes
CA200.02430 <small>selling out</small>	200	30	3,2/2,2	24	14°	
CA250.03030	250	30	3,2/2,2	30	14°	PH02
CA300.03630	300	30	3,2/2,2	36	14°	PH02
CA350.04230	350	30	3,5/2,5	42	14°	PH02
CA400.04830	400	30	4,0/2,8	48	14°	PH02
CA450.05430	450	30	4,2/2,8	54	14°	PH01
CA500.06030	500	30	4,2/2,8	60	14°	PH01
CA550.06030 NEW	550	30	5,2/3,6	60	14°	PH01
CA600.06030 NEW	600	30	5,2/3,6	60	14°	PH01
CA700.06430 NEW	700	40	6,2/4,0	64	14°	PH01

ART. CB - CBS

- For cutting along and across grain of **softwood and hardwood**, **single sided veneer-paper boards and plywood**

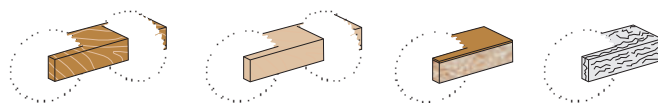

Item	D	d	B/c	Z	α	Pin holes
CB 100.02020 NEW	100	20	3,2/2,2	20	10°	
CB 120.02020 NEW	120	20	3,2/2,2	20	10°	
CB 150.02430	150	30	3,2/2,2	24	10°	
CB 180.03030	180	30	3,2/2,2	30	10°	
CB 200.03230	200	30	3,2/2,2	34	10°	
CBS250.04230	250	30	3,2/2,2	40	10°	PH02
CBS300.04830	300	30	3,2/2,2	48	10°	PH02
CBS350.05430	350	30	3,5/2,5	54	10°	PH02
CBS350.05435	350	35	3,5/2,5	54	10°	PH02
CBS400.06030	400	30	4,0/2,8	60	10°	PH02
CB 450.06630	450	30	4,2/2,8	66	10°	PH01
CB 500.07230 NEW	500	30	4,2/2,8	72	10°	PH01
CB 600.08030 NEW	600	30	5,2/3,6	80	10°	PH01
CB 700.08440 NEW	700	40	6,2/4,0	84	10°	PH01

ART. CC - CCS

- For cutting along and across grain fine finish suitable for **hardwood**, **single sided veneer-plastic boards, plywood and hardwood**

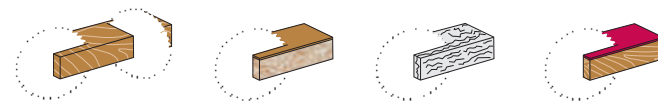

Item	D	d	B/c	Z	α	Pin holes
CC 200.04230	200	30	3,2/2,2	42	10°	
CCS250.04830	250	30	3,2/2,2	48	10°	PH02
CCS300.06030	300	30	3,2/2,2	60	10°	PH02
CCS350.07230	350	30	3,5/2,5	72	10°	PH02
CC 400.08430	400	30	4,0/2,8	80	10°	PH02

HW TRIMMING FINISHING

ART. CD/CDS - CE/CES

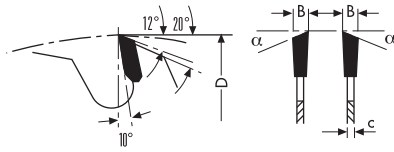

- WZ alternate top bevel teeth
- Suitable for table saws and panels saws
- Suitable for **particle board in stack**
- ♪ = no-noise
- HW grade: KCR06 (K01-C4)

Pin holes: **PH01**= 2/10/60 - **PH02**=2/7/42 + 2/9,5/46,5 + 2/10/60

ART. CD - CDS

- For cutting across grain of **exotic timber and hardwood, single sided veneer, laminate boards and plastic coated materials**
- Extra fine finish



Item	D	d	B/c	Z	Pin holes
CD 150.03630	150	30	3,2/2,2	36	
CD 200.04830	200	30	3,2/2,2	48	
CDS250.06030 ♪	250	30	3,2/2,2	60	PH02
CDS250.06035 ♪	250	35	3,2/2,2	60	PH02
CD 280.06030	280	30	3,2/2,2	60	PH02
CDS300.07230 ♪	300	30	3,2/2,2	72	PH02
CDS300.07235 ♪	300	35	3,2/2,2	72	PH02
CD 315.07230	315	30	3,2/2,2	72	PH02
CDS350.08430 ♪	350	30	3,5/2,5	84	PH02
CDS350.08435 ♪	350	35	3,5/2,5	84	PH02
CDS400.09630 ♪	400	30	4,0/2,8	96	PH02
CD 450.10830	450	30	4,2/2,8	108	PH01
CD 500.12030	500	30	4,2/3,0	120	PH01

ART. CE - CES

- For cutting across grain of **exotic and hardwood, for cutting double-sided veneer boards, single sided laminate boards, MDF and hard boards**
- Extra fine finish

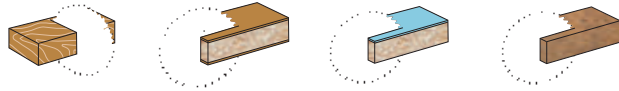

Item	D	d	B/c	Z	Pin holes
CE 150.04830	150	30	3,2/2,2	48	
CE 180.05430	180	30	3,2/2,2	56	
CE 200.06430	200	30	3,2/2,2	64	
CES250.08030 ♪	250	30	3,2/2,2	80	PH02
CES300.09630 ♪	300	30	3,2/2,2	96	PH02
CES350.10830 ♪	350	30	3,5/2,5	112	PH02
CES400.12030 ♪	400	30	4,0/2,8	120	PH02
CE 450.13230 NEW	450	30	4,2/3,0	132	PH01
CE 500.14430 NEW	500	30	4,2/3,0	144	PH01

RPM suggested referred to the blade diameter

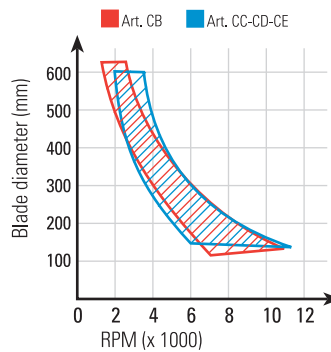

HW MULTI PURPOSE SAWBLADES (THIN KERF)

ART. CF - CG - CH

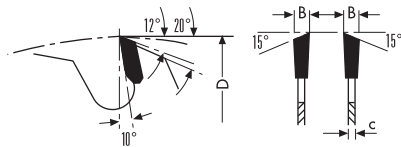

- WZ alternate teeth
- Suitable for table saws and panels saws
- With thin kerf for less friction cuts
- HW grade: HC10 (K10-C3)

Pin holes: PH02=2/7/42 + 2/9,5/46,5 + 2/10/60

ART. CF

- For cutting along and across grain of **softwood, rare woods and laminate boards**

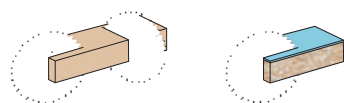

Item	D	d	B/c	Z	Pin holes
CF150.02430	150	30	2,2/1,6	24	
CF180.03030	180	30	2,2/1,6	30	
CF200.03230	200	30	2,2/1,6	34	
CF250.04030	250	30	2,2/1,6	40	PH02
CF300.04830	300	30	2,2/1,6	48	PH02
CF350.05430	350	30	2,4/1,8	54	PH02

ART. CG

- For separating plastic up to 10 mm cutting height chipboards
- For cutting along and across grain of **fine wood, hardwood, single sided veneer boards and MDF**

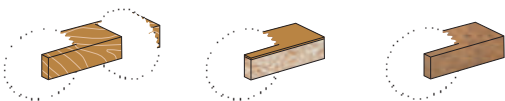

Item	D	d	B/c	Z	Pin holes
CG150.04830	150	30	2,2/1,6	48	
CG180.05630	180	30	2,2/1,6	56	
CG200.06430	200	30	2,2/1,6	64	
CG250.08030	250	30	2,2/1,6	80	PH02
CG300.09630	300	30	2,2/1,6	96	PH02
CG350.10830	350	30	2,4/1,8	108	PH02

ART. CH

- For cutting **single sided veneer boards plastic and aluminium profiles, plexiglass, pertinax, hard paper and print boards**

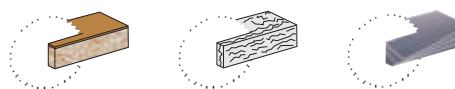

Item	D	d	B/c	Z	Pin holes
CH150.06030	150	30	2,2/1,6	60	
CH200.08030	200	30	2,2/1,6	80	
CH250.10030	250	30	2,2/1,6	100	PH02
CH300.12030	300	30	2,2/1,6	120	PH02

RPM suggested referred to the blade diameter

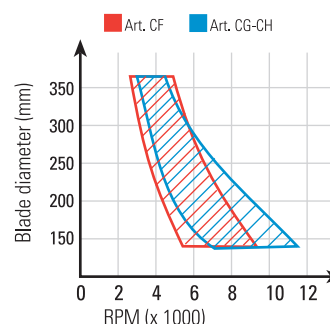

HW MULTI PURPOSE CIRCULAR SAWBLADES

ART. DA

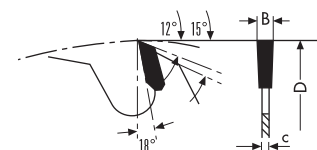

- FZ flat teeth
- For cutting along grain of all **natural woods** with large cutting heights
- For table saws
- HW grade: HC10 (K10-C3)

Pin holes: PH02=2/7/42 + 2/9,5/46,5 + 2/10/60



Item	D	d	B/c	Z	Pin holes
DA250.01830	250	30	3,2/2,2	20	PH02
DA300.02030	300	30	3,2/2,2	24	PH02
DA300.02070	300	70+ch (21x84)	3,2/2,2	24	
DA350.02430	350	30	3,5/2,5	28	PH02

HW MULTI PURPOSE CIRCULAR SAWBLADES

ART. DC

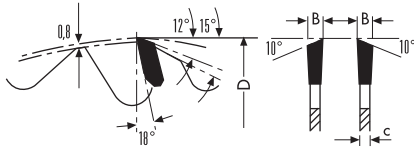

- WZ alternate top bevel teeth
- Anti-kickback design
- For cutting along and across grain of all **natural woods, wooden boarding materials, also veneered or plastic coated one size**
- For table saws
- HW grade: HC10 (K10-C3)

Pin holes: **PH01**= 2/10/60 - **PH02**=2/7/42 + 2/9,5/46,5 + 2/10/60

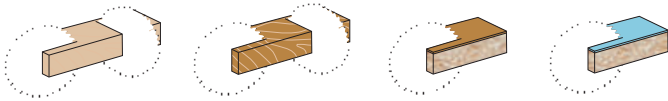

Item	D	d	B/c	Z	Pin holes
DC250.02430	250	30	3,2/2,2	24	PH02
DC300.02830	300	30	3,2/2,2	28	PH02
DC350.03230	350	30	3,5/2,5	32	PH02
DC400.03630	400	30	4,0/2,8	36	PH02
DC450.04030	450	30	4,2/2,8	40	PH01
DC500.04430	500	30	4,2/2,8	44	PH01
DC550.04430	550	30	4,2/3,0	48	PH01
DC600.05430	600	30	4,2/3,0	48	PH01

RPM suggested referred to the blade diameter

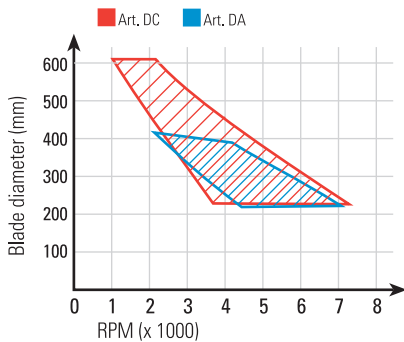

The anti-kickback design reduces the amount of wood each tooth takes away. The wood worker understands the dangers of kick back.

HW RADIAL ARM SAWBLADES

ART. FAS

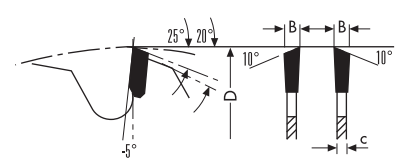

- WZ alternate top bevel teeth
- 5° negative hook angle
- For cutting across grain of **soft wood, hard wood, aluminium-wood profiles, plastic-wood profiles**
- For table saws
- no-noise
- HW grade: HC10 (K10-C3)

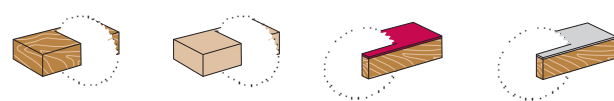

Item	D	d	B/c	Z
FAS300.03630	300	30	4,4/2,8	36
FAS350.04230	350	30	4,4/2,8	42
FAS400.04830	400	30	4,4/2,8	48

RPM suggested referred to the blade diameter

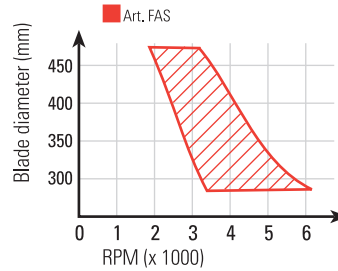

HW TRIMMING AND SIZING SAWBLADES

ART. FB

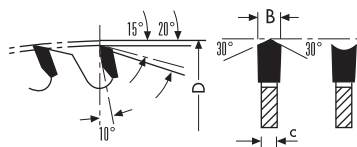

- HZ/DZ inverted "V" and hollow ground teeth
- For cutting boards with **synthetic resincoating, double sided veneer and laminate boards and plywood**
- For panel saws and table saws
- Extra finish and long cutting life
- HW grade: KCR06 (K01-C4)

Pin holes: PH02=2/7/42 + 2/9,5/46,5 + 2/10/60

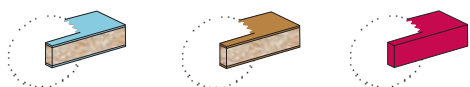

Item	D	d	B/c	Z	Pin holes
FB220.04230	220	30	3,2/2,2	42	
FB253.04830	250	30	3,2/2,2	48	PH02
FB303.06030	300	30	3,2/2,2	60	PH02
FB350.07230	350	30	3,5/2,5	72	PH02

RPM suggested referred to the blade diameter

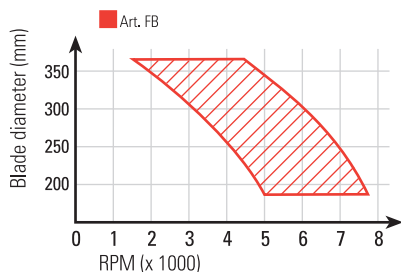

HW TRIMMING AND SIZING SAWBLADES

ART. FCS

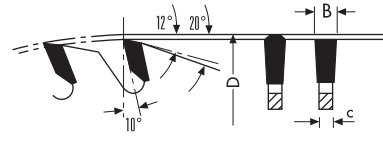

- FZ/TR triple chip teeth trapezoidal
- For table saws
- Ideal for working **ALUCOBOND®**
- For cutting **hardwoods, double sided veneer and laminate board, MDF, hard paper and thermoplastic boards**
- Extra finish and long cutting life
- ♪ = no-noise
- HW grade: KCR06 (K01-C4)

Pin holes: PH02=2/7/42 + 2/9,5/46,5 + 2/10/60



Item	D	d	B/c	Z	Pin holes
FCS250.06030 ♪	250	30	3,2/2,2	60	PH02
FCS250.08030 ♪	250	30	3,2/2,2	80	PH02
FCS300.07230 ♪	300	30	3,2/2,2	72	PH02
FCS300.09630 ♪	300	30	3,2/2,2	96	PH02
FCS350.08430 ♪	350	30	3,5/2,5	84	PH02
FCS350.11230 ♪	350	30	3,5/2,5	108	PH02

RPM suggested referred to the blade diameter

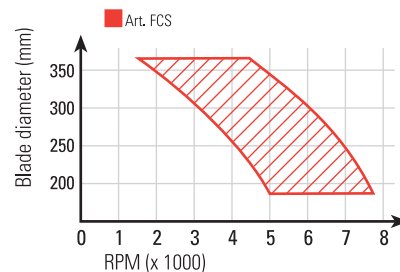

Some tips for working with multi-ripping saws

A) When operating with a multi-rip saw the use of shoulder saw blades is very important (Items FG). Positioned as the first blade on the machine side they allow, especially during heavy-duty processing or working uneven timber, that the forces have a proper distribution.

B) The use of rakers is highly recommended to avoid the saw blade rubbing on the wood, causing overheating and friction which can damage the saw blades.

C) If the machine spindle has only one keyway it is highly recommended not to use saw blades having two to avoid any unbalanced coupling.

D) Keyways of the saw blades and machine spindle are best coupled when they have the same dimensions.

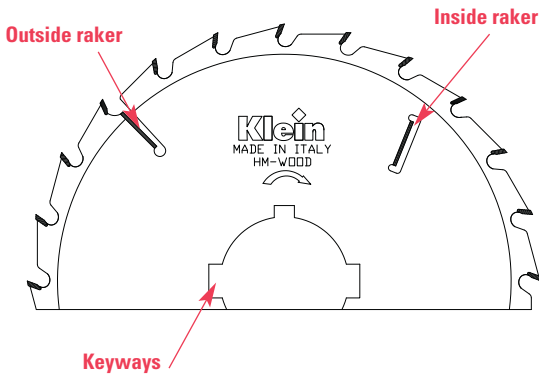

HW MULTIRIP SAWBLADES WITHOUT RAKERS

ART. FE

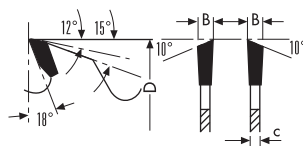

- WZ alternate top bevel teeth
- For cutting along grain of **softwood, hardwood and exotic timber**
- For multi blades saws
- HW grade: HC10 (K10-C3)



Item	D	d+keyways	B/c	Z
FE300.02870	300	70+ch (21x84)	3,2/2,2	24
FE300.02880 NEW	300	80+ch (13x90)	3,2/2,2	24
FE350.03270	350	70+ch (21x84)	3,5/2,5	28

HW SHOULDER RIP SAWBLADES WITH RAKERS

ART. FG

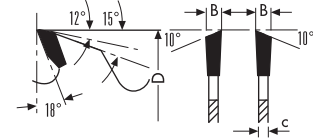

- WZ alternate teeth
- With HW rakers for better result in cutting along grain of hard wood and rare wood
- For sizing and trimming
- For multi blades saws
- HW grade: HC10 (K10-C3)



Item	D	d+keyways	B/c	Z	L max
FG300.02470 NEW	300	70+ch (21x84)	4,0/2,8	24+2+2	80
FG300.02480 NEW	300	80+ch (13x90)	4,0/2,8	24+2+2	80
FG301.02470 NEW	300	70+ch (21x84)	5,2/3,6	24+2+2	80
FG301.02475 NEW	300	75+ch (21x91)	5,2/3,6	24+2+2	80
FG301.02480 NEW	300	80+ch (13x90)	5,2/3,6	24+2+2	80
FG320.02480 NEW	320	80+ch (13x90)	4,0/2,8	24+2+2	90
FG350.02470 NEW	350	70+ch (21x84)	4,2/2,8	24+2+4	105
FG350.02475 NEW	350	75+ch (21x91)	4,2/2,8	24+2+4	105
FG350.02480 NEW	350	80+ch (14x92)	4,2/2,8	24+2+4	105
FG351.02470 NEW	350	70+ch (21x84)	4,5/3,2	24+2+2	105
FG351.02475 NEW	350	75+ch (21x91)	4,5/3,2	24+2+4	105
FG351.02480 NEW	350	80+ch (14x92)	4,5/3,2	24+2+4	105
FG352.02470 NEW	350	70+ch (21x84)	5,2/3,6	24+2+4	105
FG352.02475 NEW	350	75+ch (21x91)	5,2/3,6	24+2+4	105
FG352.02480 NEW	350	80+ch (14x92)	5,2/3,6	24+2+4	105

RPM suggested referred to the blade diameter

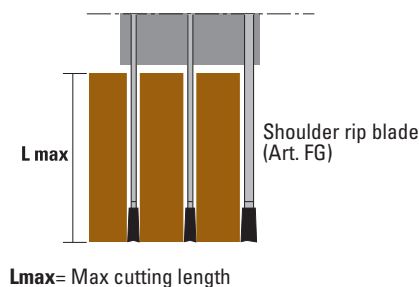
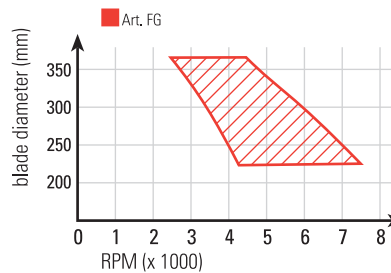

HW MULTIRIP SAWBLADES WITH RAKERS

ART. FH

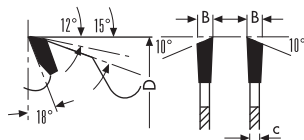

- **WZ** alternate top bevel teeth
- With HW outside and inside rakers for better result in cutting
- For cutting along grain of **softwood and hardwood** dried at 15% humidity rate, **exotic timber and rare wood**
- HW grade: **HC10 (K10-C3)**



Item	D	d+keyways	B/c	Z	L max
FH250.01830	250	30	3,2/2,2	20+2+2	65
FH250.01860	250	60+ch (21x74)	3,2/2,2	20+2+2	65
FH250.01870	250	70+ch (21x84)	3,2/2,2	20+2+2	65
FH250.01880	250	80+ch (13x90)	3,2/2,2	20+2+2	65
FH280.02070	280	70+ch (21x84)	3,2/2,2	24+2+2	65
FH280.02080	280	80+ch (13x90)	3,2/2,2	24+2+2	70

FH300.02430	300	30	3,2/2,2	24+2+4	80
FH300.02460	300	60+ch (21x74)	3,2/2,2	24+2+2	80
FH300.02470	300	70+ch (21x84)	3,2/2,2	24+2+4	80
FH300.02475	300	75+ch (21x91)	3,2/2,2	24+2+2	80
FH300.02480	300	80+ch (13x90)	3,2/2,2	24+2+4	80
FH320.02480	320	80+ch (13x90)	3,5/2,5	24+2+2	90
FH350.02475 NEW	350	75+ch (21x91)	3,5/2,5	24+2+4	105
FH350.02480 NEW	350	80+ch (14x92)	3,5/2,5	24+2+4	105
FH350.02490 NEW	350	90+ch (21x110)	3,5/2,5	24+2+4	95
FH350.02630	350	30	3,5/2,5	24+2+4	105
FH350.02660	350	60+ch (21x74)	3,5/2,5	24+2+4	105
FH350.02870	350	70+ch (21x84)	3,5/2,5	24+2+4	105

FH400.02875 NEW	400	75+ch (21x91)	4,0/2,8	28+2+4	120
FH400.02880 NEW	400	80+ch (13x90)	4,0/2,8	28+2+4	120
FH400.03030	400	30	4,0/2,8	28+2+4	120
FH400.03070	400	70+ch (21x84)	4,0/2,8	28+2+4	120

FH450.02430 NEW	450	30	4,6/3,2	24+2+4	135
FH450.02470 NEW	450	70+ch (21x84)	4,6/3,2	24+2+4	135
FH450.02475 NEW	450	75+ch (21x91)	4,6/3,2	24+2+4	135
FH450.02480 NEW	450	80+ch (13x92)	4,6/3,2	24+2+4	135
FH450.02490 NEW	450	90+ch (21x110)	4,6/3,2	24+2+4	135

FH500.02630 NEW	500	30	4,6/3,2	26+2+6	175
------------------------	-----	----	---------	--------	-----

RPM suggested referred to the blade diameter

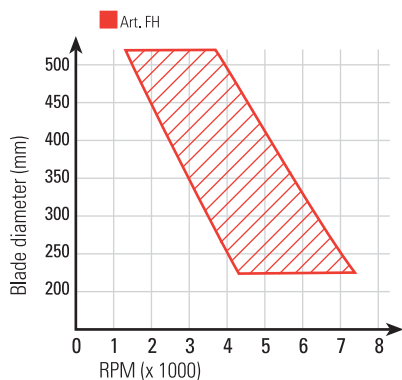

On request we can also supply multirip sawblades for "RAIMANN" machines.

HW MULTIRIP SAWBLADES WITH RAKERS (THIN KERF)

ART. FK

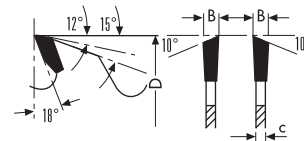

- **WZ** alternate top bevel teeth
- With HW outside and inside rakers for better result in cutting
- For cutting along grain of **softwood and hardwood** dried at 10%-15% humidity rate, **exotic timber and rare wood**
- Suitable for ripping where its thin body greatly reduces material wastes
- Ideal for processing **wooden floors and matchboardings**
- HW grade: **HC10 (K10-C3)**



Item	D	d+keyways	B/c	Z	L max
FK180.02135 NEW	180	35	2,5/1,8	21+3	30
FK180.02140 NEW	180	40	2,5/1,8	21+3	30

FK200.02135 NEW	200	35	2,5/1,8	21+3	35
FK200.02140 NEW	200	40	2,5/1,8	21+3	35

FK250.02060 NEW	250	60+ch (21x74)	2,7/1,8	20+2+2	50
FK250.02070 NEW	250	70+ch (21x84)	2,7/1,8	20+2+2	50
FK250.02080 NEW	250	80+ch (13x90)	2,7/1,8	20+2+2	50

FK300.02460 NEW	300	60+ch (21x74)	2,7/1,8	24+2+2	60
FK300.02470 NEW	300	70+ch (21x84)	2,7/1,8	24+2+2	60
FK300.02480 NEW	300	80+ch (13x90)	2,7/1,8	24+2+2	60

RPM suggested referred to the blade diameter

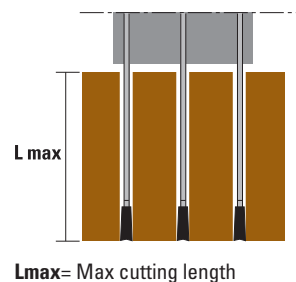
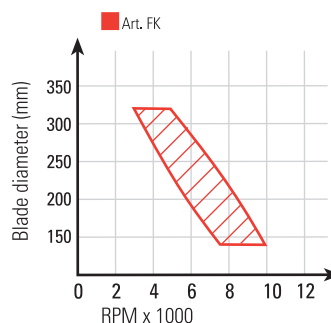

Pin holes for sizing sawblades:

Scale 1:1

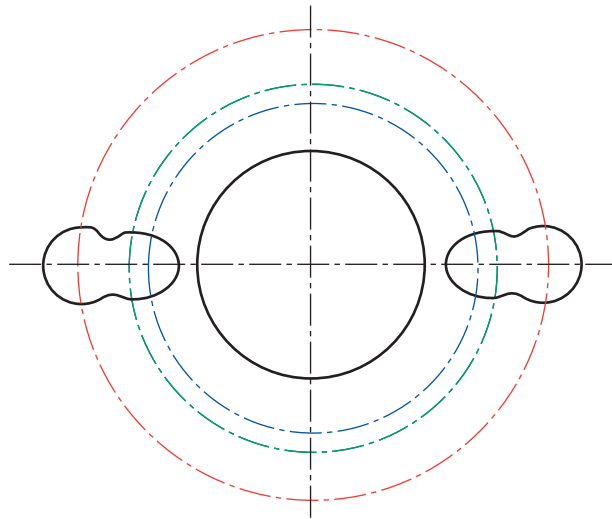

PH02

Name	Nr of holes/diameter of holes/pitch circle diameter	Machine type
PH02	2/7/42 + 2/9,5/46,5 + 2/10/60	Universal

Scale 1:1

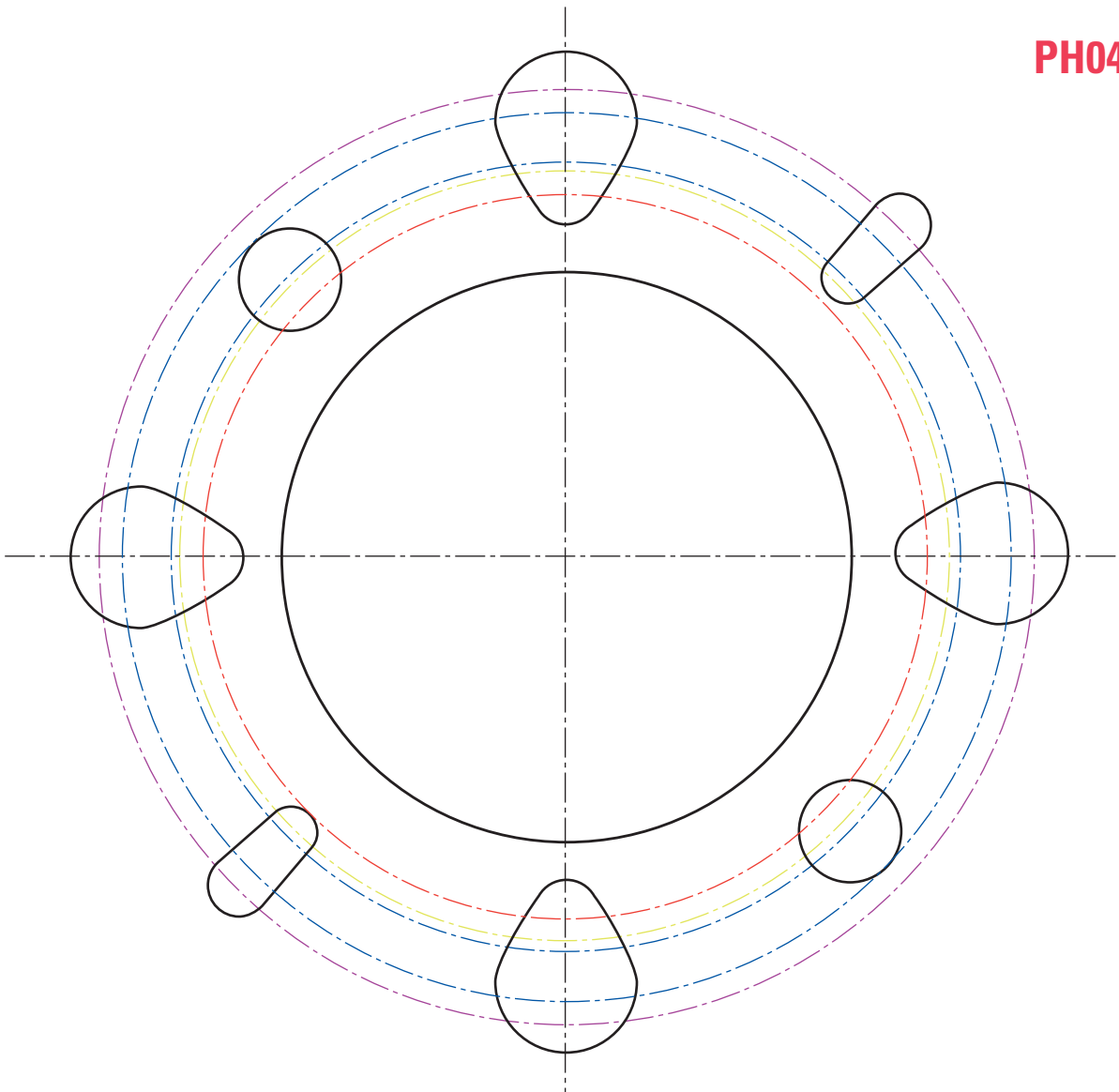

PH04

Name	Nr of holes/diameter of holes/pitch circle diameter	Machine type
PH04	2/14/110 + 2/7/110 + 4/9/100 + 4/19/120 + 2/9/130	GABBIANI - SCM - SELCO

Scale 1:1

PH05

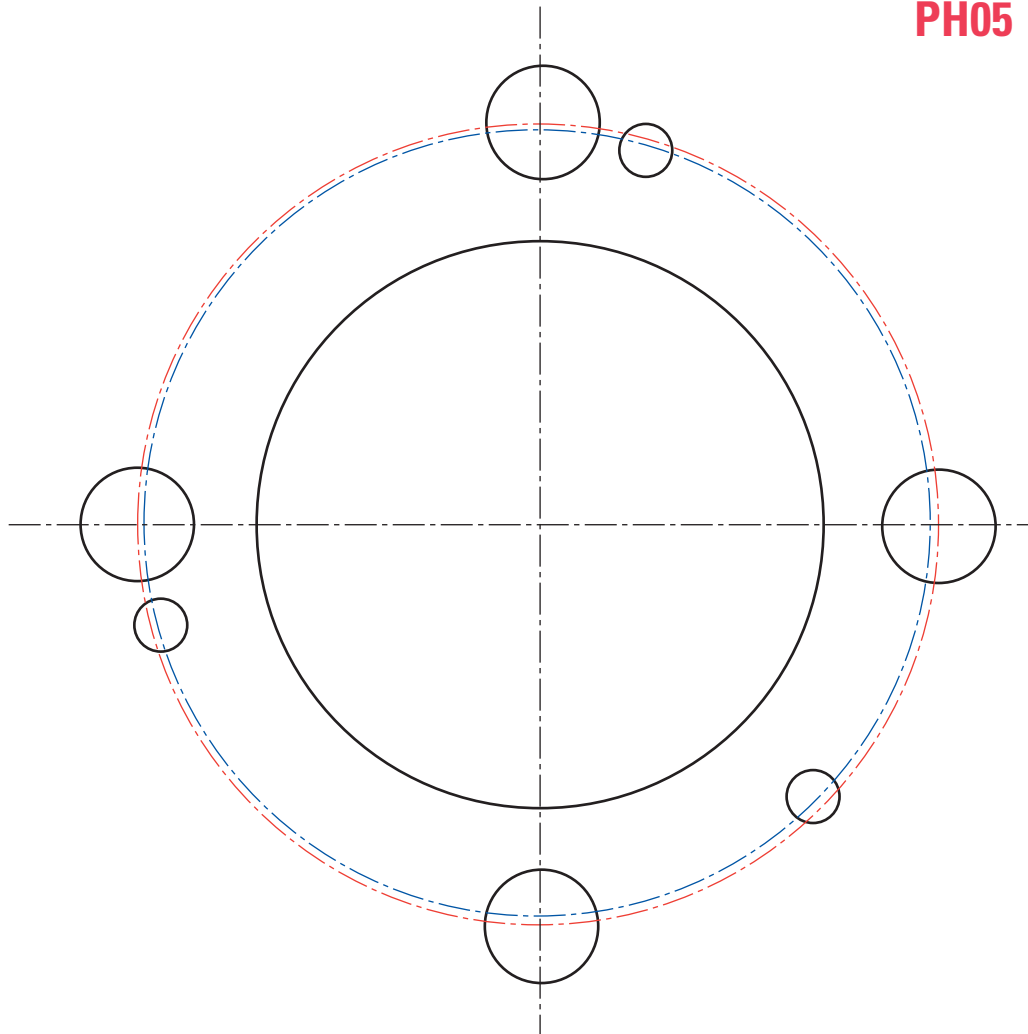

Name	Nr of holes/diameter of holes/pitch circle diameter	Machine type
PH05	4/15/105 + 3/7/100	GIBEN - HOMAG - MACMAZZA

REFERENCE TABLE OF PANEL SIZING MACHINES

ANTHON: MAIN SAWBLADE

Item	D	B	d	Z	MAT.
HCS400.07260	400	4.4/3.2	60+2	72 FZ/TR	HW
HCS430.07260	430	4.4/3.2	60+2	72 FZ/TR	HW
HCS450.07260	450	4.4/3.2	60+2	72 FZ/TR	HW
HCS531.06060	530	5.8/4.0	60+2	60 FZ/TR	HW

XHC400.07260	400	4.4/3.2	60+2	72 FZ/TR	DP
--------------	-----	---------	------	----------	----

Pin holes 2/11/85

ANTHON: SCORING SAWBLADE

Item	D	B	d	Z	MAT.
FI180.03620	180	4.3/5.5	20	36 KON/FZ	HW
FI183.03620	180	5.8/7.0	20	36 KON/FZ	HW

XFI180.03620	180	4.4/5.0	20	36 KON/FZ	DP
XFI182.03620	180	5.8/6.6	20	36 KON/FZ	DP

GABBIANI: MAIN SAWBLADE

Item	D	B	d	Z	MAT.
HCS300.06080	300	4.4/3.2	80+PH4	60 FZ/TR	HW
HCS300.07280	300	4.4/3.2	80+PH4	72 FZ/TR	HW
HCS350.05680	350	4.4/3.2	80+PH4	54 FZ/TR	HW
HCS350.07280	350	4.4/3.2	80+PH4	72 FZ/TR	HW
HCS351.07280	350	4.6/3.2	80+PH4	72 FZ/TR	HW
HCS355.07280	350	4.4/3.2	80+PH4	72 FZ/TR	HW
HCS380.07280	380	4.4/3.2	80+PH4	72 FZ/TR	HW
HCS400.06080	400	4.4/3.2	80+PH4	60 FZ/TR	HW
HCS400.07280	400	4.4/3.2	80+PH4	72 FZ/TR	HW
HCS401.07280	400	4.6/3.2	80+PH4	72 FZ/TR	HW
HCS420.07280	420	4.4/3.2	80+PH4	72 FZ/TR	HW
HCS450.07280	450	4.4/3.2	80+PH4	72 FZ/TR	HW

HBS350.05680	350	4.4/3.2	80+PH4	54 WZ	HW
HBS350.07280	350	4.4/3.2	80+PH4	72 WZ	HW
HBS400.03680	400	4.4/3.2	80+PH4	36 WZ	HW
HBS400.06080	400	4.4/3.2	80+PH4	60 WZ	HW
HBS400.07280	400	4.4/3.2	80+PH4	72 WZ	HW
HBS401.06080	400	4.6/3.2	80+PH4	60 WZ	HW
HBS450.03680	450	4.4/3.2	80+PH4	36 WZ	HW
HBS450.05480	450	4.4/3.2	80+PH4	54 WZ	HW

XHC350.07280	350	4.4/3.2	80+PH4	72 FZ/TR	DP
XHC400.07280	400	4.4/3.2	80+PH4	72 FZ/TR	DP
XHC450.07280	450	4.4/3.2	80+PH4	72 FZ/TR	DP

Pin holes 2/14/110+2/7/110+4/9/100

GABBIANI: SCORING SAWBLADE

Item	D	B	d	Z	MAT.
FI161.03655	160	4.3/5.5	55+3	36 KON/FZ	HW
FI162.03655	160	4.5/5.7	55+3	36 KON/FZ	HW
FI163.03655	160	4.7/6.0	55+3	36 KON/FZ	HW

XFI160.03655	160	4.4/5.0	55+3	36 KON/FZ	DP
--------------	-----	---------	------	-----------	----

Pin holes 3/7/66

GIBEN: MAIN SAWBLADE

Item	D	B	d	Z	MAT.
HCS320.06050	320	4.4/3.2	50+8	60 FZ/TR	HW
HCS320.07250	320	4.4/3.2	50+8	72 FZ/TR	HW
HCS330.06050	330	4.4/3.2	50+8	60 FZ/TR	HW
HCS350.07250	350	4.4/3.2	50+8	72 FZ/TR	HW
HCS360.07250	360	4.4/3.2	50+8	72 FZ/TR	HW
HCS380.07250	380	4.4/3.2	50+8	72 FZ/TR	HW

HBS320.03650	320	4.4/3.2	50+8	36 WZ	HW
--------------	-----	---------	------	-------	----

XHC320.06050	320	4.4/3.2	50+8	60 FZ/TR	DP
XHC330.06050	330	4.4/3.2	50+8	60 FZ/TR	DP
XHC350.07250	350	4.4/3.2	50+8	72 FZ/TR	DP
XHC360.07250	360	4.4/3.2	50+8	72 FZ/TR	DP

Pin holes 6/12.5/80+2/12.5/80

HCS320.07275	320	4.4/3.2	75+3	72 FZ/TR	HW
--------------	-----	---------	------	----------	----

Pin holes 3/13/95

HCS350.05675	350	4.4/3.2	75+PH5	54 FZ/TR	HW
HCS350.07275	350	4.4/3.2	75+PH5	72 FZ/TR	HW
HCS355.07275	355	4.4/3.2	75+PH5	72 FZ/TR	HW
HCS380.07250	380	4.4/3.2	75+PH5	72 FZ/TR	HW
HCS400.06075	400	4.4/3.2	75+4	60 FZ/TR	HW
HCS400.07275	400	4.4/3.2	75+4	72 FZ/TR	HW
HCS430.07275	430	4.4/3.2	75+4	72 FZ/TR	HW
HCS430.09675	430	4.4/3.2	75+4	96 FZ/TR	HW
HCS470.07275	470	4.4/3.2	75+4	72 FZ/TR	HW
HCS470.09675	470	4.4/3.2	75+4	96 FZ/TR	HW

HBS350.05675	350	4.4/3.2	75+PH5	54 WZ	HW
HBS350.07275	350	4.4/3.2	75+PH5	72 WZ	HW
HBS400.06075	400	4.4/3.2	75+4	60 WZ	HW
HBS400.07275	400	4.4/3.2	75+4	72 WZ	HW
HBS401.06075	400	4.6/3.2	75+4	60 WZ	HW

XHC350.07275	350	4.4/3.2	75+4	72 FZ/TR	DP
XHC400.07275	400	4.4/3.2	75+4	72 FZ/TR	DP
XHC430.07275	430	4.4/3.2	75+4	72 FZ/TR	DP
XHC470.07275	470	4.4/3.2	75+4	72 FZ/TR	DP

Pin holes

HCS550.07299	550	5.2/3.5	100	72 FZ/TR	HW
HCS565.07299	565	5.2/3.5	100	72 FZ/TR	HW

GIBEN: SCORING SAWBLADE

Item	D	B	d	Z	MAT.
FI127.02045	125	4.0/4.8	45	20+20 KON/FZ	HW
FI126.02445	125	4.3/5.5	45	24 KON/FZ	HW
XFI126.02045	125	4.0/4.8	45	20+20 KON/FZ	DP
FI161.03645	160	4.3/5.5	45+3	36 KON/FZ	HW
FI162.03645	160	4.5/5.7	45+3	36 KON/FZ	HW

XFI160.03645	160	4.4/5.0	45+3	36 KON/FZ	DP
--------------	-----	---------	------	-----------	----

Pin holes 3/11/70

FI180.03650	180	4.3/5.5	50+3	44 KON/FZ	HW
-------------	-----	---------	------	-----------	----

XFI180.04450	180	4.4/5.0	50+3	44 KON/FZ	DP
--------------	-----	---------	------	-----------	----

Pin holes 3/12.5/80

FI182.03655	180	5.0/6.2	55	36 KON/FZ	HW
-------------	-----	---------	----	-----------	----

FI215.04250	215	4.3/5.5	50+3	42 KON/FZ	HW
FI216.04250	215	4.5/5.7	50+3	42 KON/FZ	HW
FI300.04850	300	4.3/5.5	50+3	48 KON/FZ	HW
FI301.04850	300	4.5/5.7	50+3	48 KON/FZ	HW

XFI215.04250	215	4.4/5.0	50+3	42 KON/FZ	DP
--------------	-----	---------	------	-----------	----

Pin holes 3/15/80

HOLZMA: MAIN SAWBLADE

Item	D	B	d	Z	MAT.
HCS350.07260	350	4.4/3.2	60+2	72 FZ/TR	HW
HCS380.07260	380	4.4/3.2	60+2	72 FZ/TR	HW
HCS381.06050	380	4.8/3.5	60+2	72 FZ/TR	HW
HCS381.08460	380	4.8/3.5	60+2	84 FZ/TR	HW
XHC350.07260	350	4.4/3.2	60+2	72 FZ/TR	DP
XHC380.07260	380	4.8/3.5	60+2	72 FZ/TR	DP
Pin holes 2/14/100					
HCS402.07260	400	4.8/3.5	60+4	72 FZ/TR	HW
XHC401.07260	400	4.8/3.5	60+4	72 FZ/TR	DP
Pin holes 2/14/100+2/14/125					
HCS421.07260	420	4.8/3.5	60+2	72 FZ/TR	HW
HCS450.07260	450	4.4/3.2	60+2	72 FZ/TR	HW
HCS452.07260	450	4.8/3.5	60+2	72 FZ/TR	HW
XHC420.07260	420	4.8/3.5	60+2	72 FZ/TR	DP
XHC451.07260	450	4.8/3.5	60+2	72 FZ/TR	DP
Pin holes 2/14/125					
HCS500.06060	500	4.8/3.5	60+2	60 FZ/TR	HW
HCS500.07260	500	4.8/3.5	60+2	72 FZ/TR	HW
XHC500.07260	500	4.8/3.5	60+2	72 FZ/TR	DP
Pin holes 2/11/115					
HCS481.07260	480	4.8/3.5	60+4	72 FZ/TR	HW
HCS520.06060	520	4.8/3.5	60+4	60 FZ/TR	HW
HCS540.08460	540	4.8/3.5	60+4	84 FZ/TR	HW
HCS541.06060	540	5.8/4.0	60+4	60 FZ/TR	HW
HCS570.06060	570	4.8/3.5	60+4	60 FZ/TR	HW
HCS571.09660	570	5.8/4.0	60+4	96 FZ/TR	HW
HCS600.06060	600	5.8/4.0	60+4	60 FZ/TR	HW
HCS600.07260	600	5.8/4.0	60+4	72 FZ/TR	HW
XHC481.07260	480	4.8/3.5	60+4	72 FZ/TR	DP
XHC520.06060	520	4.8/3.5	60+4	60 FZ/TR	DP
Pin holes 2/11/115+2/19/120					

GIBEN: SCORING SAWBLADE

Item	D	B	d	Z	MAT.
FI180.03645	180	4.3/5.5	45	36 KON/FZ	HW
FI181.03645	180	4.7/6.0	45	36 KON/FZ	HW
FI200.03645	200	4.3/5.5	45	36 KON/FZ	HW
FI201.03645	200	4.7/6.0	45	36 KON/FZ	HW
FI204.03645	200	5.8/7.0	45	36 KON/FZ	HW
XFI180.03645	180	4.4/5.0	45	36 KON/FZ	DP
XFI181.03645	180	4.8/5.6	45	36 KON/FZ	DP
XFI200.03645	200	4.4/5.0	45	36 KON/FZ	DP
XFI201.03645	200	4.8/5.6	45	36 KON/FZ	DP
XFI203.03645	200	5.8/6.6	45	36 KON/FZ	DP

HOMAG: MAIN SAWBLADE

Item	D	B	d	Z	MAT.
HCS300.06075	300	4.4/3.2	75	60 FZ/TR	HW
HCS350.05675	350	4.4/3.2	75	54 FZ/TR	HW
HCS350.07275	350	4.4/3.2	75	72 FZ/TR	HW
HCS355.07275	355	4.4/3.2	75	72 FZ/TR	HW
HCS400.06075	400	4.4/3.2	75	60 FZ/TR	HW
HCS400.07275	400	4.4/3.2	75	72 FZ/TR	HW
HBS350.05675	350	4.4/3.2	75	54 WZ	HW
HBS350.07275	350	4.4/3.2	75	72 WZ	HW
HBS400.06075	400	4.4/3.2	75	60 WZ	HW
HBS400.07275	400	4.4/3.2	75	72 WZ	HW
HBS401.06075	400	4.6/3.2	75	60 WZ	HW
XHC350.07275	350	4.4/3.2	75	72 FZ/TR	DP
XHC400.07275	400	4.4/3.2	75	72 FZ/TR	DP

HOMAG: SCORING SAWBLADE

Item	D	B	d	Z	MAT.
FI126.02445	125	4.3/5.5	45	24 KON/FZ	HW
FI151.03645	150	4.3/5.5	45	36 KON/FZ	HW
FI180.03645	180	4.3/5.5	45	36 KON/FZ	HW
FI200.03645	200	4.3/5.5	45	36 KON/FZ	HW
XFI160.03645	160	4.4/5.0	45	36 KON/FZ	DP
XFI180.03645	180	4.4/5.0	45	36 KON/FZ	DP
XFI200.03645	200	4.4/5.0	45	36 KON/FZ	DP

MACMAZZA: MAIN SAWBLADE

Item	D	B	d	Z	MAT.
HCS350.05675	350	4.4/3.2	75+3	54 FZ/TR	HW
HCS350.07275	350	4.4/3.2	75+3	72 FZ/TR	HW
HCS355.07275	355	4.4/3.2	75+3	72 FZ/TR	HW
HCS380.07275	380	4.4/3.2	75+3	72 FZ/TR	HW
HBS350.05675	350	4.4/3.2	75+3	54 WZ	HW
HBS350.07275	350	4.4/3.2	75+3	72WZ	HW
XHC350.07275	350	4.4/3.2	75+3	72 FZ/TR	DP
Pin holes 3/7/100					
HCS450.07275	450	4.4/3.2	75+3	72 FZ/TR	HW
Pin holes 3/7/120					

MACMAZZA: SCORING SAWBLADE

Articolo	D	B	d	Z	MAT.
FI161.03655	160	4.3/5.5	55+3	36 KON/FZ	HW
FI280.04855	280	4.5/5.6	55+3	48 KON/FZ	HW
XFI160.03645	160	4.4/5.0	55+3	36 KON/FZ	DP
Pin holes 3/6/84					

MAYER: MAIN SAWBLADE

Item	D	B	d	Z	MAT.
HCS300.06030	300	4.4/3.2	30+PH1	60 FZ/TR	HW
HCS300.07230	300	4.4/3.2	30+PH1	72 FZ/TR	HW
HCS350.05630	350	4.4/3.2	30+PH1	54 FZ/TR	HW
HCS350.07230	350	4.4/3.2	30+PH1	72 FZ/TR	HW
HCS400.06030	400	4.4/3.2	30+2	60 FZ/TR	HW
HCS400.07230	400	4.4/3.2	30+2	72 FZ/TR	HW

HBS300.04830	300	4.4/3.2	30+PH1	48A	HW
HBS300.06030	300	4.4/3.2	30+PH1	60A	HW
HBS300.07230	300	4.4/3.2	30+PH1	72A	HW
HBS350.05430	350	4.4/3.2	30+PH1	54A	HW
HBS350.07230	350	4.4/3.2	30+PH1	72A	HW
HBS400.06030	400	4.4/3.2	30+2	60A	HW
HBS400.07230	400	4.4/3.2	30+2	72A	HW

XHC300.06030	300	4.4/3.2	30+PH1	60 FZ/TR	DP
XHC350.07230	350	4.4/3.2	30+PH1	72 FZ/TR	DP
XHC400.07230	400	4.4/3.2	30+2	72 FZ/TR	DP

Pin holes 2/10/60

MAYER: SCORING SAWBLADE

Item	D	B	d	Z	MAT.
FL127.02045	125	4.0/4.8	45	20+20 KON/FZ	HW
FI126.02445	125	4.3/5.5	45	24 KON/FZ	HW
FI151.03630	150	4.3/5.5	30	36 KON/FZ	HW
XFI126.02045	125	4.0/4.8	45	20+20 KON/FZ	DP

PANHANS: MAIN SAWBLADE

Item	D	B	d	Z	MAT.
HCS300.06030	300	4.4/3.2	30+PH1	60 FZ/TR	HW
HCS300.07230	300	4.4/3.2	30+PH1	72 FZ/TR	HW
HCS350.05430	350	4.4/3.2	30+PH1	54 FZ/TR	HW
HCS350.07230	350	4.4/3.2	30+PH1	72 FZ/TR	HW
HCS400.06030	400	4.4/3.2	30+PH1	60 FZ/TR	HW
HCS400.07230	400	4.4/3.2	30+PH1	72 FZ/TR	HW
HCS450.07230	450	4.4/3.2	30+2	72 FZ/TR	HW

HBS300.04830	300	4.4/3.2	30+PH1	48 WZ	HW
HBS300.06030	300	4.4/3.2	30+PH1	60 WZ	HW
HBS300.07230	300	4.4/3.2	30+PH1	72 WZ	HW
HBS350.05430	350	4.4/3.2	30+PH1	54 WZ	HW
HBS350.07230	350	4.4/3.2	30+PH1	72 WZ	HW
HBS400.06030	400	4.4/3.2	30+2	60 WZ	HW
HBS400.07230	400	4.4/3.2	30+2	72 WZ	HW
HBS450.05430	450	4.4/3.2	30+2	54 WZ	HW
HBS450.07230	450	4.4/3.2	30+2	72 WZ	HW

XHC300.06030	300	4.4/3.2	30+PH1	60 FZ/TR	DP
XHC350.07230	350	4.4/3.2	30+PH1	72 FZ/TR	DP
XHC400.07230	400	4.4/3.2	30+2	72 FZ/TR	DP

Pin holes 2/10/60

PANHANS: SCORING SAWBLADE

Item	D	B	d	Z	MAT.
FI126.02420	125	4.3/5.5	20	24 KON/FZ	HW
FI180.03630	180	4.3/5.5	30	36 KON/FZ	HW
FI200.03630	200	4.3/5.5	30	36 KON/FZ	HW
XFI200.03630	200	4.4/5.0	30	36 KON/FZ	DP

SCHELLING: MAIN SAWBLADE

Item	D	B	d	Z	MAT.
HCS350.05630	350	4.4/3.2	30+PH1	54 FZ/TR	HW
HCS350.07230	350	4.4/3.2	30+PH1	72 FZ/TR	HW
HCS370.07230	370	4.4/3.2	30+2	72 FZ/TR	HW
HCS400.06030	400	4.4/3.2	30+PH1	60 FZ/TR	HW
HCS400.07230	400	4.4/3.2	30+PH1	72 FZ/TR	HW

HBS350.05430	350	4.4/3.2	30+PH1	54 WZ	HW
HBS350.07230	350	4.4/3.2	30+PH1	72 WZ	HW
HBS400.06030	400	4.4/3.2	30+2	60 WZ	HW
HBS400.07230	400	4.4/3.2	30+2	72 WZ	HW

XHC300.06030	300	4.4/3.2	30+PH1	60 FZ/TR	DP
XHC350.07230	350	4.4/3.2	30+PH1	72 FZ/TR	DP
XHC370.07230	370	4.4/3.2	30+2	72 FZ/TR	DP
XHC400.07230	400	4.4/3.2	30+2	72 FZ/TR	DP

Pin holes 2/10/60

HCS450.07230	450	4.4/3.2	30+2	72 FZ/TR	HW
HCS460.07230	460	4.4/3.2	30+2	72 FZ/TR	HW
HCS480.07230	480	4.4/3.2	30+2	72 FZ/TR	HW
HCS500.07230	500	4.6/3.2	30+2	72 FZ/TR	HW
HCS520.07230	520	4.8/3.5	30+2	72 FZ/TR	HW
HCS530.06030	530	5.0/3.5	30+2	60 FZ/TR	HW

HBS450.05430	450	4.4/3.2	30+2	54 WZ	HW
HBS450.05430	450	4.4/3.2	30+2	72 WZ	HW
HBS500.07230	500	4.6/3.2	30+2	72 WZ	HW

XHC450.07230	450	4.4/3.2	30+2	72 FZ/TR	DP
XHC460.07230	460	4.4/3.2	30+2	72 FZ/TR	DP
XHC480.07230	480	4.4/3.2	30+2	72 FZ/TR	DP

Pin holes 2/13/94

HCS550.06040	550	5.2/3.5	40+2	60 FZ/TR	HW
--------------	-----	---------	------	----------	----

Pin holes 2/13/122

SCHELLING: SCORING SAWBLADE

Item	D	B	d	Z	MAT.
FI180.03630	180	4.3/5.5	20	36 KON/FZ	HW
FI200.03620	200	4.3/5.5	20	36 KON/FZ	HW
FI203.03620	200	5.0/6.2	20	36 KON/FZ	HW

XFI180.03620	180	4.4/5.0	20	36 KON/FZ	DP
XFI200.03620	200	4.4/5.0	20	36 KON/FZ	DP
XFI201.03620	200	5.0/5.8	20	36 KON/FZ	DP

SCM: MAIN SAWBLADE

Item	D	B	d	Z	MAT.
HCS300.06080	300	4.4/3.2	80+PH4	60 FZ/TR	HW
HCS300.07280	300	4.4/3.2	80+PH4	72 FZ/TR	HW
HCS350.05680	350	4.4/3.2	80+PH4	54 FZ/TR	HW
HCS350.07280	350	4.4/3.2	80+PH4	72 FZ/TR	HW
HCS351.07280	350	4.6/3.2	80+PH4	72 FZ/TR	HW
HCS355.07280	355	4.4/3.2	80+PH4	72 FZ/TR	HW
HCS380.07280	380	4.4/3.2	80+PH4	72 FZ/TR	HW
HCS400.06080	400	4.4/3.2	80+PH4	60 FZ/TR	HW
HCS400.07280	400	4.4/3.2	80+PH4	72 FZ/TR	HW
HCS401.07280	400	4.6/3.2	80+PH4	72 FZ/TR	HW

HBS350.05680	350	4.4/3.2	80+PH4	54 WZ	HW
HBS350.07280	350	4.4/3.2	80+PH4	72 WZ	HW
HBS400.03680	400	4.4/3.2	80+PH4	36 WZ	HW
HBS400.04880	400	4.4/3.2	80+PH4	48 WZ	HW
HBS400.06080	400	4.4/3.2	80+PH4	60 WZ	HW
HBS400.07280	400	4.4/3.2	80+PH4	72 WZ	HW
HBS401.06080	400	4.6/3.2	80+PH4	60 WZ	HW
HBS450.03680	450	4.4/3.2	80+PH4	36 WZ	HW
HBS450.05480	450	4.4/3.2	80+PH4	54 WZ	HW

XHC350.07280	350	4.4/3.2	80+PH4	72 FZ/TR	DP
XHC400.07280	400	4.4/3.2	80+PH4	72 FZ/TR	DP
XHC450.07280	450	4.4/3.2	80+PH4	72 FZ/TR	DP

Pin holes 2/14/110+2/7/110+4/9/100

SCM: SCORING SAWBLADE

Item	D	B	d	Z	MAT.
FI151.03655	150	4.3/5.5	55+3	36 KON/FZ	HW
FI161.03655	160	4.3/5.5	55+3	36 KON/FZ	HW
FI162.03655	160	4.5/5.7	55+3	36 KON/FZ	HW
XFI160.03645	160	4.4/5.0	55+3	36 KON/FZ	DP

Pin holes 3/7/66

SELCO: MAIN SAWBLADE

Item	D	B	d	Z	MAT.
HCS300.06065	300	4.4/3.2	65+4	60 FZ/TR	HW
HCS300.07265	300	4.4/3.2	65+4	72 FZ/TR	HW
HCS320.06065	320	4.4/3.2	65+4	60 FZ/TR	HW
HCS321.06065	320	4.6/3.2	65+4	60 FZ/TR	HW
HCS350.07265	350	4.4/3.2	65+4	72 FZ/TR	HW
HCS361.07265	360	4.6/3.2	65+4	72 FZ/TR	HW

XHC300.06065	300	4.4/3.2	65+4	60 FZ/TR	DP
XHC320.06065	320	4.4/3.2	65+4	60 FZ/TR	DP
XHC350.07265	350	4.4/3.2	65+4	72 FZ/TR	DP
XHC360.07265	360	4.4/3.2	65+4	72 FZ/TR	DP

Pin holes 2/9/100+2/9/110

HCS350.05680	350	4.4/3.2	80+PH4	54 FZ/TR	HW
HCS350.07280	350	4.4/3.2	80+PH4	72 FZ/TR	HW
HCS351.07280	350	4.6/3.2	80+PH4	72 FZ/TR	HW
HCS355.07280	355	4.4/3.2	80+PH4	72 FZ/TR	HW
HCS400.06080	400	4.4/3.2	80+PH4	60 FZ/TR	HW
HCS400.07280	400	4.4/3.2	80+PH4	72 FZ/TR	HW
HCS401.07280	400	4.6/3.2	80+PH4	72 FZ/TR	HW
HCS430.07280	430	4.4/3.2	80+PH4	72 FZ/TR	HW
HCS450.07280	450	4.4/3.2	80+PH4	72 FZ/TR	HW
HCS451.07280	450	4.6/3.2	80+PH4	72 FZ/TR	HW
HCS452.07280	450	4.8/3.5	80+PH4	72 FZ/TR	HW
HCS480.07280	480	4.8/3.5	80+6	72 FZ/TR	HW
HCS481.07280	480	5.2/3.5	80+6	72 FZ/TR	HW

HBS350.05480	350	4.4/3.2	80+PH4	54 WZ	HW
HBS350.07280	350	4.4/3.2	80+PH4	72 WZ	HW
HBS400.03680	400	4.4/3.2	80+PH4	36 WZ	HW
HBS400.04880	400	4.4/3.2	80+PH4	48 WZ	HW
HBS400.06080	400	4.4/3.2	80+PH4	60 WZ	HW
HBS400.07280	400	4.4/3.2	80+PH4	72 WZ	HW
HBS401.06080	400	4.6/3.2	80+PH4	60 WZ	HW
HBS450.03680	450	4.4/3.2	80+PH4	36 WZ	HW
HBS450.05480	450	4.4/3.2	80+PH4	54 WZ	HW
HBS451.04880	450	4.8/3.5	80+PH4	48 WZ	HW

XHC350.07280	350	4.4/3.2	80+PH4	72 FZ/TR	DP
XHC400.07280	400	4.4/3.2	80+PH4	72 FZ/TR	DP
XHC430.07280	430	4.4/3.2	80+PH4	72 FZ/TR	DP
XHC450.07280	450	4.4/3.2	80+PH4	72 FZ/TR	DP
XHC451.07280	450	4.8/3.5	80+PH4	72 FZ/TR	DP
XHC481.07280	480	4.8/3.5	80+6	72 FZ/TR	DP

Pin holes 4/19/120+2/9/130

SELCO: SCORING SAWBLADE

Item	D	B	d	Z	MAT.
FI200.03665	200	4.3/5.5	65+4	36 KON/FZ	HW
FI201.03665	200	4.7/6.0	65+4	36 KON/FZ	HW
FI202.03665	200	4.5/5.7	65+4	36 KON/FZ	HW
FI203.03665	200	5.0/6.2	65+4	36 KON/FZ	HW
FI300.07265	300	4.3/5.5	65+4	72 KON/FZ	HW
FI301.07265	300	4.5/5.7	65+4	72 KON/FZ	HW
FI302.07265	300	4.7/6.0	65+4	72 KON/FZ	HW

XFI200.03665	200	4.4/5.0	65+4	36 KON/FZ	DP
XFI200.03645	200	4.8/5.6	65+4	36 KON/FZ	DP

Pin holes 2/9/100+2/9/110

HW CONICAL SCORING SAWBLADES

ART. FI

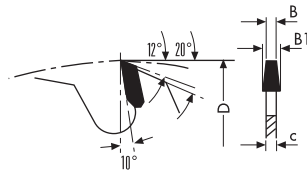

- **KON/FZ** conical teeth
- For cutting double sided **veneer and laminate boards, MDF and particle board**
- To be used on panel sizing machines that allow the vertical adjustment of the scorer in relation to the panel sizing sawblade
- **HW grade: KCR05 (K01-C4)**

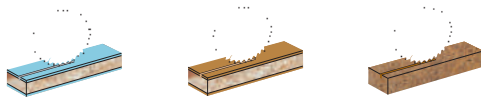

Item	D	d	B-B1/c	Z	Pin holes
FI080.01220 NEW	80	20	3,1-4,0/2,2	12	
FI100.02020	100	20	3,1-4,3/2,2	20	
FI100.02022	100	22	3,1-4,3/2,2	20	
FI110.02020	110	20	3,1-4,3/2,2	20	
FI110.02022	110	22	3,1-4,3/2,2	20	
FI120.02420	120	20	3,1-4,3/2,2	20	
FI120.02422	120	22	3,1-4,3/2,2	20	
FI121.02420 <i>selling out</i>	120	20	4,3-5,5/2,8	24	
FI121.02445 <i>selling out</i>	120	45	4,3-5,5/2,8	24	
FI122.02020 NEW	120	20	3,4-4,5/2,2	20	
FI125.02420	125	20	3,1-4,3/2,2	24	
FI125.02445	125	45	3,1-4,3/2,2	24	
FI126.02420	125	20	4,3-5,5/3,2	24	
FI126.02422	125	22	4,3-5,5/3,2	24	
FI126.02445	125	45	4,3-5,5/3,2	24	
FI127.02420 NEW	125	20	3,4-4,5/2,2	24	
FI127.02430 NEW	125	30	3,4-4,5/2,2	24	
FI150.02430 <i>selling out</i>	150	30	3,4-4,6/2,2	24	
FI150.03630	150	30	3,4-4,5/2,2	36	
FI150.03645 <i>selling out</i>	150	45	3,4-4,5/2,2	36	
FI150.03650 <i>selling out</i>	150	50	3,4-4,5/2,2	36	
FI151.02430	150	30	4,3-5,5/3,2	24	
FI151.02445 NEW	150	45	4,3-5,5/3,2	24	
FI151.03630	150	30	4,3-5,5/3,2	36	
FI151.03645 NEW	150	45	4,3-5,5/3,2	36	Giben
FI151.03655 NEW	150	55	4,3-5,5/3,2	36	Gabbiani
FI152.03630 NEW	150	30	3,9-5,1/2,8	36	
FI153.03630 NEW	150	30	3,1-4,3/2,2	36	

Item	D	d	B-B1/c	Z	Pin holes
FI161.02430 NEW	160	30	4,3-5,5/3,2	36	
FI161.03620 NEW	160	20	4,3-5,5/3,2	36	
FI161.03645 NEW	160	45	4,3-5,5/3,2	36	Giben
FI161.03655 NEW	160	55	4,3-5,5/3,2	36	MacMazza Gabbiani
FI162.03645 NEW	160	45	4,5-5,7/3,2	36	Giben
FI162.03655 NEW	160	55	4,5-5,7/3,2	36	Gabbiani
FI163.03655 NEW	160	55	4,7-6,0/3,5	36	Gabbiani
FI180.03620	180	20	4,3-5,5/3,2	36	
FI180.03630 NEW	180	30	4,3-5,5/3,2	36	2/10/60
FI180.03650 NEW	180	50	4,3-5,5/3,2	44	Giben
FI180.03645	180	45	4,3-5,5/3,2	36	Holzma
FI180.03655	180	55	4,3-5,5/3,2	36	Giben
FI181.03645 NEW	180	45	4,7-6,0/3,5	36	Holzma
FI182.03655 NEW	180	55	5,0-6,2/3,5	36	Giben
FI183.03620 NEW	180	20	5,8-7,0/4,0	36	Anthon
FI200.03620	200	20	4,3-5,5/3,2	36	
FI200.03630	200	30	4,3-5,5/3,2	36	
FI200.03645	200	45	4,3-5,5/3,2	36	Holzma
FI200.03665	200	65	4,3-5,5/3,2	36	Selco
FI200.03680	200	80	4,3-5,5/3,2	36	Gabbiani
FI201.03645	200	45	4,7-6,0/3,5	36	Holzma
FI201.03665	200	65	4,7-6,0/3,5	36	Selco
FI202.03665 NEW	200	65	4,5-5,7/3,2	36	Selco
FI203.03665 NEW	200	65	5,0-6,2/3,5	36	Selco
FI204.03645 NEW	200	45	5,8-7,0/4,0	36	Holzma
FI215.04250 NEW	215	50	4,3-5,5/3,2	42	Giben
FI216.04250 NEW	215	50	4,5-5,7/3,2	42	Giben
FI280.04855 NEW	280	55	4,5-5,6/3,2	48	MacMazza
FI300.04850 NEW	300	50	4,3-5,5/3,2	48	Giben
FI300.07265 NEW	300	65	4,3-5,5/3,2	72	Selco
FI301.04850 NEW	300	50	4,5-5,7/3,2	48	Giben
FI301.07265 NEW	300	65	4,5-5,7/3,2	72	Selco
FI302.07265 NEW	300	65	4,7-6,0/3,5	72	Selco

HW ADJUSTABLE SCORING SAWBLADES

ART. FL

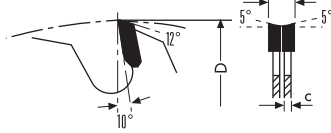

- LFZ flat teeth
- Supplied with spacers
- For cutting double sided veneer and laminate boards, MDF and particle board
- For panel sizing machines
- QHW grade: KCR05 (K01-C4)

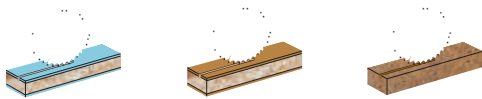

Item	D	d	B/c	Z
FL080.01020 NEW	80	20	2,8-3,6/2,2	10+10
FL100.01220	100	20	2,8-3,6/2,2	10+10
FL100.01222	100	22	2,8-3,6/2,2	10+10
FL101.01220 NEW	100	20	3,1-3,9/2,2	10+10
FL101.01222 NEW	100	22	3,1-3,9/2,2	10+10
FL120.01220	120	20	2,8-3,6/2,2	12+12
FL120.01222	120	22	2,8-3,6/2,2	12+12
FL121.01220 NEW	120	20	3,1-3,9/2,2	12+12
FL121.01222 NEW	120	22	3,1-3,9/2,2	12+12
FL125.01220	125	20	2,8-3,6/2,2	12+12
FL125.01222	125	22	2,8-3,6/2,2	12+12
FL126.01220 NEW	125	20	3,1-3,9/2,2	12+12
FL126.01222 NEW	125	22	3,1-3,9/2,2	12+12
FL126.01230 NEW	125	30	3,1-3,9/2,2	12+12
FL127.02045 NEW	125	45	4,0-4,8/2,2	20+20 Giben

HW adjustable scoring sawblades unit without rings

FL120.01250AN NEW	120	50+4	2,8-3,8/2,2	12+12
--------------------------	-----	------	-------------	-------

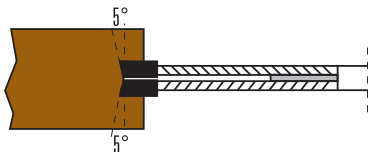

HW PANEL SIZING SAWBLADES

ART. HBS

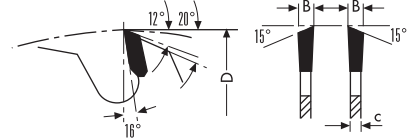

- WZ alternate top bevel teeth
- For cutting double sided veneer and laminate boards, MDF and particle board
- = no-noise with a special sound absorbing resin inside the silent slots
- HW grade: KCR05 (K01-C4)

Pin holes:

PH01= 2/10/60

PH02= 2/7/42 + 2/9,5/46,5 + 2/10/60

PH04= 2/14/110 + 2/7/110 + 4/9/100 + 4/19/120 + 2/9/130 (Selco-Gabbani-SCM)

PH05= 4/15/105 + 3/7/100 (Giben-Homag-MacMazza)

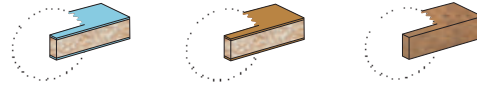

Item	D	d	B/c	Z	Pin holes
HBS300.04830	300	30	4,4/3,2	48	PH02
HBS300.06030	300	30	4,4/3,2	60	PH02
HBS300.07230 NEW	300	30	4,4/3,2	72	PH02
HBS320.03650 NEW	320	50	4,4/3,2	36	Giben
HBS350.05630	350	30	4,4/3,2	54	PH02
HBS350.05675	350	75	4,4/3,2	54	PH05
HBS350.05680	350	80	4,4/3,2	54	PH04
HBS350.07230	350	30	4,4/3,2	72	PH02
HBS350.07275	350	75	4,4/3,2	72	PH05
HBS350.07280	350	80	4,4/3,2	72	PH04
HBS400.03630	400	30	4,4/3,2	36	PH01
HBS400.03680 NEW	400	80	4,4/3,2	36	PH04
HBS400.06030	400	30	4,4/3,2	60	PH01
HBS400.06075	400	75	4,4/3,2	60	Giben-Homag
HBS400.06080	400	80	4,4/3,2	60	PH04
HBS400.07230	400	30	4,4/3,2	72	PH01
HBS400.07275	400	75	4,4/3,2	72	Giben-Homag
HBS400.07280	400	80	4,4/3,2	72	PH04
HBS401.06075 NEW	400	75	4,6/3,2	60	Giben-Homag
HBS401.06080 NEW	400	80	4,6/3,2	60	PH04
HBS450.03680 NEW	450	80	4,4/3,2	36	PH04
HBS450.05430	450	30	4,4/3,2	54	PH01 +Schelling
HBS450.05480 NEW	450	80	4,4/3,2	54	PH04
HBS450.07230	450	30	4,4/3,2	72	PH01 +Schelling
HBS451.04880 NEW	450	80	4,8/3,5	48	PH04
HBS500.07230	500	30	4,6/3,2	72	PH01 +Schelling

HW PANEL SIZING SAWBLADES

ART. HCS

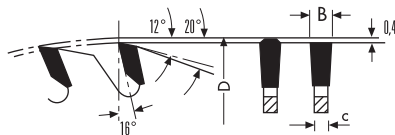

- FZ-TR triple chip teeth
- For cutting double sided veneer and laminate boards, MDF, particle board and plastic materials
- = no-noise with a special sound absorbing resin inside the silent slots
- HW grade: KCR05 (K01-C4)

Pin holes:

PH01= 2/10/60 - PH02= 2/7/42 + 2/9,5/46,5 + 2/10/60

PH04= 2/14/110 + 2/7/110 + 4/9/100 + 4/19/120 + 2/9/130 (Selco-Gabbani-SCM)

PH05= 4/15/105 + 3/7/100 (Giben-Homag-MacMazza)



Item	D	d	B/c	Z	Pin holes
HCS300.06030	300	30	4,4/3,2	60	PH02
HCS300.06065 NEW	300	65	4,4/3,2	60	Selco
HCS300.06075	300	75	4,4/3,2	60	Homag
HCS300.06080	300	80	4,4/3,2	60	Gabbiani
HCS300.07230 NEW	300	30	4,4/3,2	72	PH02
HCS300.07265 NEW	300	65	4,4/3,2	72	Selco
HCS300.07280 NEW	300	80	4,4/3,2	72	Gabbiani
HCS320.06050 NEW	320	50	4,4/3,2	60	Giben
HCS320.06065 NEW	320	65	4,4/3,2	60	Selco
HCS320.07250 NEW	320	50	4,4/3,2	72	Giben
HCS320.07275 NEW	320	75	4,4/3,2	72	Giben
HCS321.06065 NEW	320	65	4,6/3,2	60	Selco
HCS330.06050 NEW	330	50	4,4/3,2	60	Giben
HCS350.05630	350	30	4,4/3,2	54	PH02
HCS350.05675	350	75	4,4/3,2	54	PH05
HCS350.05680	350	80	4,4/3,2	54	PH04
HCS350.07230	350	30	4,4/3,2	72	PH02
HCS350.07250 NEW	350	50	4,4/3,2	72	Giben
HCS350.07260 NEW	350	60	4,4/3,2	72	Holzma
HCS350.07265 NEW	350	65	4,4/3,2	72	Selco
HCS350.07275	350	75	4,4/3,2	72	PH05
HCS350.07280	350	80	4,4/3,2	72	PH04
HCS351.07280 NEW	350	80	4,6/3,2	72	PH04
HCS355.07230 NEW	355	30	4,4/3,2	72	PH02
HCS355.07275 NEW	355	75	4,4/3,2	72	PH05
HCS355.07280 NEW	355	80	4,4/3,2	72	PH04
HCS360.07250 NEW	360	50	4,4/3,2	72	Giben
HCS361.07265 NEW	360	65	4,6/3,2	72	Selco
HCS370.07230 NEW	370	30	4,4/3,2	72	Schelling
HCS380.07250 NEW	380	50	4,4/3,2	72	Giben
HCS380.07260 NEW	380	60	4,4/3,2	72	Holzma
HCS380.07275 NEW	380	75	4,4/3,2	72	PH05
HCS380.07280 NEW	380	80	4,4/3,2	72	PH04
HCS381.07260 NEW	380	60	4,8/3,5	72	Holzma
HCS381.08460 NEW	380	60	4,8/3,5	84	Holzma

Item	D	d	B/c	Z	Pin holes
HCS400.06030	400	30	4,4/3,2	60	PH01
HCS400.06075	400	75	4,4/3,2	60	Giben-Homag
HCS400.06080	400	80	4,4/3,2	60	PH04
HCS400.07230	400	30	4,4/3,2	72	PH01
HCS400.07260	400	60	4,4/3,2	72	Anthon
HCS400.07275	400	75	4,4/3,2	72	Giben-Homag
HCS400.07280	400	80	4,4/3,2	72	PH04
HCS401.07280 NEW	400	80	4,6/3,2	72	PH04
HCS402.07260 NEW	400	60	4,8/3,5	72	Holzma
HCS420.07280 NEW	420	80	4,4/3,2	72	PH04
HCS421.07260 NEW	420	60	4,8/3,5	72	Holzma
HCS430.07230 NEW	430	30	4,4/3,2	72	PH01
HCS430.07260 NEW	430	60	4,4/3,2	72	Anthon
HCS430.07275 NEW	430	75	4,4/3,2	72	Giben
HCS430.07280	430	80	4,4/3,2	72	PH04
HCS430.09675 NEW	430	75	4,4/3,2	96	Giben
HCS431.07280 NEW	430	80	4,6/3,2	72	PH04
HCS450.07230	450	30	4,4/3,2	72	Schelling
HCS450.07260	450	60	4,4/3,2	72	Anthon-Holzma
HCS450.07275 NEW	450	75	4,4/3,2	72	MacMazza
HCS450.07280	450	80	4,4/3,2	72	PH04
HCS451.07280 NEW	450	80	4,6/3,2	72	PH04
HCS452.07260 NEW	450	60	4,8/3,5	72	Holzma
HCS452.07280 NEW	450	80	4,8/3,5	72	PH04
HCS460.07230 NEW	460	30	4,4/3,2	72	Schelling
HCS470.07275 NEW	470	75	4,4/3,2	72	Giben
HCS470.09675 NEW	470	75	4,4/3,2	96	Giben
HCS480.07230 NEW	480	30	4,4/3,2	72	Schelling
HCS481.07260 NEW	480	60	4,8/3,5	72	Holzma
HCS481.07280 NEW	480	80	4,8/3,5	72	Selco
HCS482.07280 NEW	480	80	5,2/3,5	72	Selco
HCS500.06060 NEW	500	60	4,8/3,5	60	Holzma
HCS500.07230 NEW	500	30	4,6/3,2	72	Schelling
HCS500.07260 NEW	500	60	4,8/3,5	72	Holzma
HCS520.06060 NEW	520	60	4,8/3,5	60	Holzma
HCS520.07230 NEW	520	30	4,8/3,5	72	Schelling
HCS530.06030 NEW	530	30	5,0/3,5	60	Schelling
HCS531.06060 NEW	530	60	5,8/4,0	60	Anthon
HCS540.08460 NEW	540	60	4,8/3,5	84	Holzma
HCS541.06060 NEW	540	60	5,8/4,0	60	Holzma
HCS550.06040 NEW	550	40	5,2/3,5	60	Schelling
HCS550.07299 NEW	550	100	5,2/3,5	72	Giben
HCS565.07299 NEW	550	100	5,2/3,5	72	Giben
HCS570.06060 NEW	570	60	4,8/3,5	60	Holzma
HCS571.09660 NEW	570	60	5,8/4,0	96	Holzma
HCS600.06060 NEW	600	60	5,8/4,0	60	Holzma
HCS600.07260 NEW	600	60	5,8/4,0	72	Holzma

HW SCORING SAWBLADES FOR EDGE BANDING AND SQUARING MACHINES

ART. FM

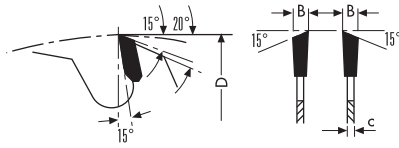

- **WZ** alternate top bevel teeth
- For cutting double sided **veneer and laminate boards, MDF and particle board**
- **HW grade: KCR06 (K01-C4)**

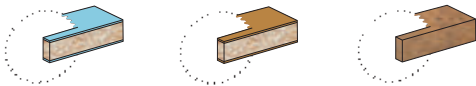

Item	D	d	B/c	Z
FM100.02020	100	20	3,2/2,2	20
FM115.02430 NEW	115	30	2,6/1,8	24
FM120.03020	120	20	3,2/2,2	30
FM125.02020	125	20	3,2/2,2	20
FM160.04830	160	30	3,2/2,2	48

HW SCORING SAWBLADES FOR EDGE BANDING AND SQUARING MACHINES

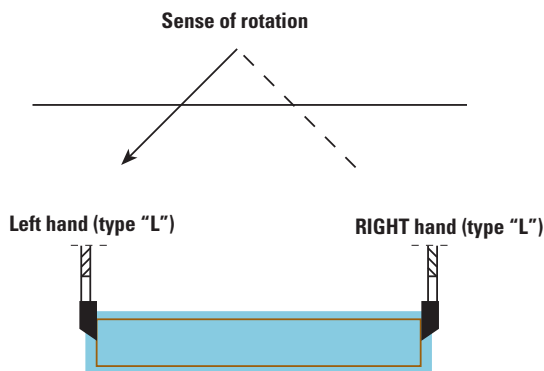

HW SCORING SAWBLADES FOR EDGE BANDING AND SQUARING MACHINES

ART. FP

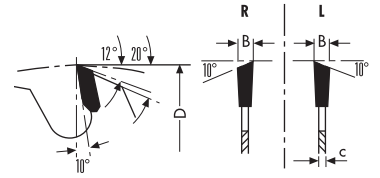

- **ES** 1 sided top bevel teeth
- **R**= right hand
- **L**= left hand
- For cutting double sided **veneer and laminate boards, thermoplastic boards, MDF and chipboard**
- **HW grade: KCR06 (K01-C4)**



Item	D	d	B/c	Z
FP100.02020R	100	20	3,2/2,2	20
FP100.02020L	100	20	3,2/2,2	20
FP115.02430R NEW	115	30 Stefani	2,6/1,8	24
FP115.02430L NEW	115	30 Stefani	2,6/1,8	24
FP120.03020R	120	20	3,2/2,2	30
FP120.03020L	120	20	3,2/2,2	30
FP125.03020R	125	20	3,2/2,2	30
FP125.03020L	125	20	3,2/2,2	30
FP150.03620R	150	20	3,2/2,2	36
FP150.03620L	150	20	3,2/2,2	36
FP150.03630R	150	30	3,2/2,2	36
FP150.03630L	150	30	3,2/2,2	36
FP150.03655R	150	55	3,2/2,2	36
FP150.03655L	150	55	3,2/2,2	36
FP150.04820R	150	20	3,2/2,2	48
FP150.04820L	150	20	3,2/2,2	48
FP150.04830R	150	30	3,2/2,2	48
FP150.04830L	150	30	3,2/2,2	48
FP150.04855R	150	55	3,2/2,2	48
FP150.04855L	150	55	3,2/2,2	48
FP180.03630R NEW	180	30	3,2/2,2	36
FP180.03630L NEW	180	30	3,2/2,2	36
FP180.03655R NEW	180	55	3,2/2,2	36
FP180.03655L NEW	180	55	3,2/2,2	36
FP180.03660R NEW	180	60	3,2/2,2	36
FP180.03660L NEW	180	60	3,2/2,2	36
FP200.04830R NEW	200	30	3,2/2,2	48
FP200.04830L NEW	200	30	3,2/2,2	48
FP200.04840R NEW	200	40	3,2/2,2	48
FP200.04840L NEW	200	40	3,2/2,2	48
FP200.04880R NEW	200	80	3,2/2,2	48
FP200.04880L NEW	200	80	3,2/2,2	48

LIST OF MACHINES (SAWBLADES FOR BUILDING)

Diameter	Brand	Model-no.	
250 x 30	De Walt	DW250, DW320, 1251, 1501, 1503	
		DW710, DW125, DW150, DW720, DW742	
	Elu	TGS 171, TGS 172, 170, 171, 172, 173,	
		TKS171	
	Haffner	TGS 162, Sp 198, GS 166, AKS, GS 150	
		Sp 195, Sp189, Sp 197, TGS198, GS1	
		2W, 2D	
	Metabo	TK 1685 Magnum, TK 1685D, TK 1685,	
		TK 1688, TK 1688D, TKU 1633, TKU 1693	
	Ulmia	1610, 1622, 1625, 1711	
	Scheppach	TKS 250	
	Elektra-Beckum	PK 3100 WM 250, PK 4200 DN 4200	
		PK 6000 DN 250, KS 250, KGS 250, GKS 300	
	Festo	AD85-1, AE85	
	Flottjet	1011, 2011, 3011	
Mafell	MKS85, MS85, Erika 85		
Stayer	SLL250, SCE250, CP66		
300 x 30	De Walt	DW 1370, 142 DS, 160 DS, 1635,	
		4L/1875/2155 3, 3L	
	Haffner	Sp223, TGS 168, GS 157,	
		GS 158, TGS 169, Sp 224	
	Ulmia	1711, 1712, 1725	
	Metabo	TK 1685 Magnum	
	Schleicher	330, 310	
	Holz-Her	PKS 1212, -1211, -1215, -1220,	
		PKS 275 -1210, -1213	
	315 x 30	Haffner	KS 120
		Hanning	HTK 315, 3 VS
		Mafell	Biberex, Biber
		Matabo	TK 1685 Magnum
		Scheppach	TKH, TKU, TK
		Elektra-Beckum	Combi HS 315
Lutz		KKS 400, JUMBO 2000, RBK 500	
Alko		Holzmeister S, Holzmeister H	
Atika		ATK 315 H	
Lescha		TKS 315 N, TKS 315 H, TKS 315 HS	
350 x 30	De Walt	C14	
	Ulmia	1711, 1712, 1725	
400 x 30	De Walt	C 14, 163546+62, 2155-4+6	
	Haffner	KS 155/DGS 184, DGS 184 E	
	Mafell	VKS 130, VKS 160, AZB,	
		TD3, TDH4, TK 150, BK3	
	Holz-Her	B7K, 277	
	Avola	ZB 400, ABH 400	
	Atika	ABK 400, ABH 400	
	Lutz	LBK 500	
	Elektra	BS 3100 WNB/400, BS 4200 DNB/400	
		BS 6000 DNB/500	
	450 x 30	Mafell	BKV4, TDH5, TDH 450, BK
		Avola	ZBV 450, ZB 450
		Atika	ABH 450, BWK 450, ATU
	Elektra-Beckum	BS 3100 WNB/400,	
		BS4200 DNB/400, BS600 DNB/500	
Lutz	RKS 700		
Alko	W 450/W500		
Scheppach	BS 500, BSH 500, WS 500		

HW SAWBLADES FOR BUILDING SITES

ART. GA

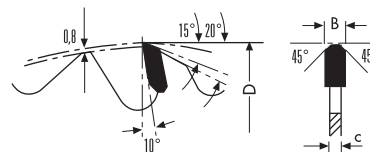

- **FZ/FA** flat, beveled teeth with anti-kickback design
- For cutting **slab woods and boards, timber with parts of concrete and metal (nails, metal fittings), porous concrete blocks**
- For table saws
- **HW grade: HC10 (K10-C3)**

Pin holes: **PH01= 2/10/60**



Item	D	d	B/c	Z	Pin holes
GA300.02030	300	30	3,2/2,2	20 +anti-kickback	PH01
GA315.02030	315	30	3,2/2,2	20 +anti-kickback	PH01
GA350.02430	350	30	3,2/2,2	24 +anti-kickback	PH01
GA400.02830 selling out	400	30	3,8/2,8	28 +anti-kickback	PH01

HW SAWBLADES FOR BUILDING SITES WITH COATING

ART. GB

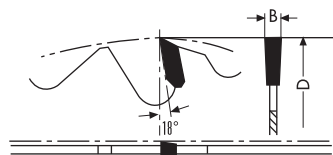

- **LFZ** flat teeth with anti-kickback design
- For cutting along and across grain in all, **wooden materials**
- Non-adhesive coated
- For table saws
- **HW grade: HC10 (K10-C3)**

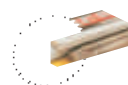

Item	D	d	B/c	Z
GB250.01630 selling out	250	30	3,0/2,0	16
GB350.02230 selling out	350	30	3,0/2,0	22
GB400.02430 selling out	400	30	3,5/2,8	24

HW SAWBLADES FOR ALUMINIUM

ART. LA

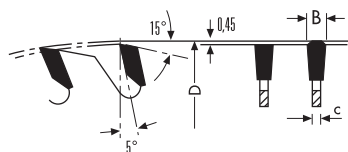

- FZ/TR triple chip teeth
- 5° positive hook angle
- For Alu, PVC and non-ferrous metals
- For table saws
- = no-noise with a special sound absorbing resin inside the silent slots
- HW grade: HC10 (K10-C3)

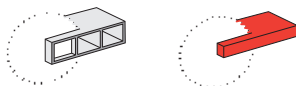

Item	D	d	B/c	Z	Pin holes
LA200.06430	200	30	3,2/2,5	64	2/11/63
LA200.06432	200	32	3,2/2,5	64	2/11/63
LA250.06030	250	30	3,4/2,6	60	2/11/63
LA250.06032	250	32	3,4/2,6	60	2/11/63
LA250.08030	250	30	3,4/2,6	80	2/11/63
LA250.08032	250	32	3,4/2,6	80	2/11/63
LA300.07230	300	30	3,4/2,6	72	2/11/63
LA300.07232	300	32	3,4/2,6	72	2/11/63
LA300.08430	300	30	3,4/2,6	84	2/11/63
LA300.08432	300	32	3,4/2,6	84	2/11/63
LA300.09630	300	30	3,4/2,6	96	2/11/63
LA300.09632	300	32	3,4/2,6	96	2/11/63
LA350.08430	350	30	3,4/2,6	84	2/11/63
LA350.08432	350	32	3,4/2,6	84	2/11/63
LA350.09630	350	30	3,4/2,6	96	2/11/63
LA350.09632	350	32	3,4/2,6	96	2/11/63
LA350.10830	350	30	3,4/2,6	108	2/11/63
LA350.10832	350	32	3,4/2,6	108	2/11/63
LA400.09630	400	30	4,0/3,2	96	2/11/63
LA400.09632	400	32	4,0/3,2	96	2/11/63
LA400.12030	400	30	4,0/3,2	120	2/11/63
LA400.12032	400	32	4,0/3,2	120	2/11/63
LA420.09632 NEW	420	32	4,0/3,2	96	2/11/63
LA450.09630	450	30	4,0/3,2	96	2/11/63
LA450.09632	450	32	4,0/3,2	96	2/11/63
LA450.10830	450	30	4,0/3,2	108	2/11/63
LA450.10832	450	32	4,0/3,2	108	2/11/63
LA500.12030	500	30	4,6/3,6	120	2/11/63
LA500.12032	500	32	4,6/3,6	120	2/11/63
LA500.12132 NEW	500	32	4,0/3,2	120	2/11/63
LA550.14030 NEW	550	30	4,6/3,6	140	2/11/63
LA600.14030 NEW	600	30	4,6/3,6	140	2/11/63

HW SAWBLADES FOR ALUMINIUM

ART. LB

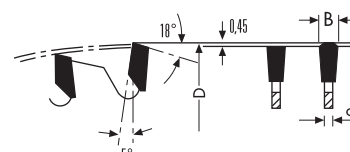

- FZ/TR triple chip teeth
- 5° negative hook angle
- For Alu, PVC and non-ferrous metals
- For table saws
- = no-noise with a special sound absorbing resin inside the silent slots
- HW grade: HC10 (K10-C3)

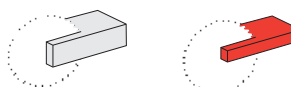

Item	D	d	B/c	Z	Pin holes
LB200.06430	200	30	3,2/2,5	64	2/11/63
LB200.06432	200	32	3,2/2,5	64	2/11/63
LB250.06030	250	30	3,4/2,6	60	2/11/63
LB250.08030	250	30	3,4/2,6	80	2/11/63
LB250.08032	250	32	3,4/2,6	80	2/11/63
LB300.07230	300	30	3,4/2,6	72	2/11/63
LB300.08430	300	30	3,4/2,6	84	2/11/63
LB300.08432	300	32	3,4/2,6	84	2/11/63
LB300.09630	300	30	3,4/2,6	96	2/11/63
LB300.09632	300	32	3,4/2,6	96	2/11/63
LB350.08430	350	30	3,4/2,6	84	2/11/63
LB350.08432	350	32	3,4/2,6	84	2/11/63
LB350.09630	350	30	3,4/2,6	96	2/11/63
LB350.09632	350	32	3,4/2,6	96	2/11/63
LB350.10830	350	30	3,4/2,6	108	2/11/63
LB350.10832	350	32	3,4/2,6	108	2/11/63
LB400.09630	400	30	4,0/3,2	96	2/11/63
LB400.09632	400	32	4,0/3,2	96	2/11/63
LB400.12030	400	30	4,0/3,2	120	2/11/63
LB400.12032	400	32	4,0/3,2	120	2/11/63
LB450.09630	450	30	4,0/3,2	96	2/11/63
LB450.09632	450	32	4,0/3,2	96	2/11/63
LB450.10830	450	30	4,0/3,2	108	2/11/63
LB450.10832	450	32	4,0/3,2	108	2/11/63
LB500.12030	500	30	4,6/3,6	120	2/11/63
LB500.12032	500	32	4,6/3,6	120	2/11/63
LB550.14030 NEW	550	30	4,6/3,6	140	2/11/63
LB600.14030 NEW	600	30	4,6/3,6	140	2/11/63

RPM suggested referred to the blade diameter

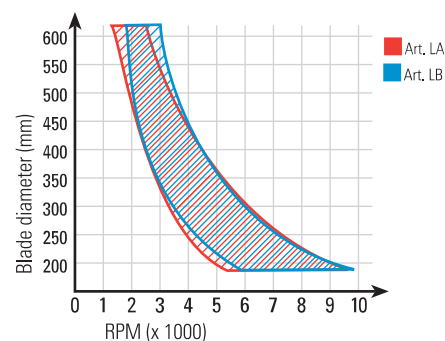

HW GROOVING SAWBLADES

ART. KA

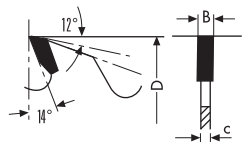

- FZ flat teeth
- For cutting along and across grain of **hardwood, softwood, timber wood, and plastic coated panel**
- For producing grooves
- HW grade: KCR06 (K01-C4)

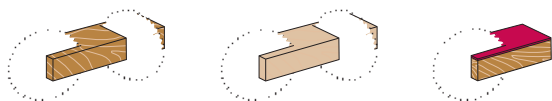

Item	D	d	B/c	Z
KA125.0123015	125	30	1,5/1,1	12
KA125.0123018	125	30	1,8/1,3	12
KA125.0123020	125	30	2,0/1,4	12
KA125.0123025	125	30	2,5/1,6	12
KA125.0123030	125	30	3,0/2,0	12
KA125.0123035	125	30	3,5/2,5	12
KA125.0123040	125	30	4,0/2,8	12
KA125.0123045	125	30	4,5/3,2	12
KA125.0123050	125	30	5,0/4,0	12
KA125.0123060	125	30	6,0/4,0	12
KA125.0123070	125	30	7,0/6,0	12
KA125.0123080	125	30	8,0/6,0	12
KA125.0123090	125	30	9,0/6,0	12
KA125.0123099	125	30	10,0/6,0	12

KA150.0183015	150	30	1,5/1,1	18
KA150.0183018	150	30	1,8/1,3	18
KA150.0183020	150	30	2,0/1,4	18
KA150.0183025	150	30	2,5/1,6	18
KA150.0183030	150	30	3,0/2,0	18
KA150.0183035	150	30	3,5/2,5	18
KA150.0183040	150	30	4,0/2,8	18
KA150.0183050	150	30	5,0/4,0	18
KA150.0183060	150	30	6,0/4,0	18
KA150.0183070	150	30	7,0/6,0	18
KA150.0183080	150	30	8,0/6,0	18
KA150.0183090	150	30	9,0/6,0	18
KA150.0183099	150	30	10,0/6,0	18

KA180.0243020	180	30	2,0/1,4	24
KA180.0243025	180	30	2,5/1,6	24
KA180.0243030	180	30	3,0/2,0	24
KA180.0243035	180	30	3,5/2,5	24
KA180.0243040	180	30	4,0/2,8	24
KA180.0243050	180	30	5,0/4,0	24
KA180.0243060	180	30	6,0/4,0	24
KA180.0243070	180	30	7,0/6,0	24
KA180.0243080	180	30	8,0/6,0	24
KA180.0243090	180	30	9,0/6,0	24
KA180.0243099	180	30	10,0/6,0	24

HW "DRY" OR "QUATTRO" SAWBLADES

ART. LZ

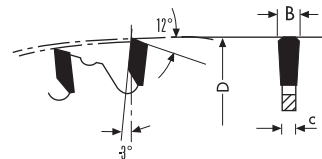

- TR special form of teeth
- 3° negative hook angle
- For cutting wood, **ferrous and no-ferrous material, plastic and compound materials**
- For hand saws, mitre-saws and table saws
- HW grade: SMX (P20 - P25 - C6)



Item	D	d	B/c	Z	Pin holes
LZ150.03020	150	20	2,2/1,6	30	
LZ160.03020	160	20	2,2/1,6	30	
LZ170.03030	170	30	2,2/1,6	30	
LZ180.03430	180	30	2,2/1,6	30	
LZ190.03830	190	30	2,2/1,6	38	

LZ200.04030	200	30	2,2/1,6	40	
LZ210.04030	210	30	2,2/1,6	40	
LZ230.04430	230	30	2,2/1,6	40	2/7/42

LZ250.04820	250	20	2,4/1,8	48	2/7/42
LZ250.04830	250	30	2,4/1,8	48	2/7/42

LZ300.06026	300	25,4	2,4/1,8	60	2/7/42+2/10/60
LZ300.06030	300	30	2,4/1,8	60	2/7/42+2/10/60

LZ305.06026	305	25,4	2,4/1,8	60	2/7/42+2/10/60
LZ305.08026	305	25,4	2,4/1,8	80	2/7/42+2/10/60

LZ350.08030	350	30	2,6/2,0	70	2/7/42+2/10/60
LZ355.08026	355	25,4	2,6/2,0	80	2/7/42+2/10/60

LZ400.08430	400	30	3,0/2,0	84	2/10/60
-------------	-----	----	---------	----	---------

RPM suggested referred to the blade diameter

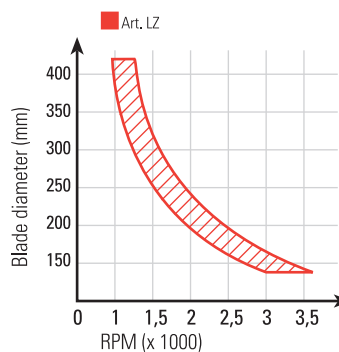

HW SAWBLADES FOR "SOLID SURFACE"

ART. MES

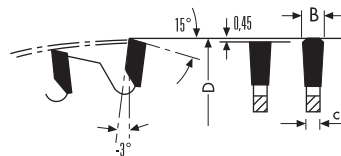

- FZ/TR triple chip teeth
- 3° negative hook angle
- Ideal for cutting solid surface "Corian®" "Varicor" ecc
- Suitable for **plexiglass and plastic materials**
- High finishing grade, no scratch, no risk of material melting
- **No-noise**
- HW grade: KCR05 (K01-C4)

Pin holes: PH02= 2/7/42 + 2/9,5/46,5 + 2/10/60

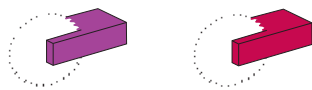

Item	D	d	B/c	Z	Pin holes
MES250.06030	250	30	3,2/2,5	60	PH02
MES250.08030	250	30	3,2/2,5	80	PH02
MES300.08430	300	30	3,2/2,5	84	PH02
MES300.09630	300	30	3,2/2,5	96	PH02
MES350.11230	350	30	3,2/2,5	108	PH02

RPM suggested referred to the blade diameter

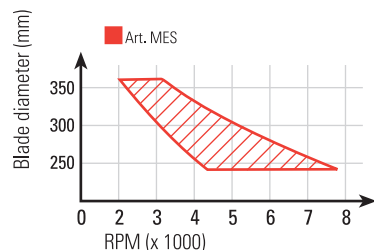

HW SAWBLADES FOR PVC AND PLEXIGLASS

ART. MGS

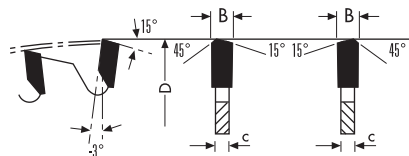

- WZ/FA alternate-trap, teeth
- 3° negative hook angle
- Suitable for **thin plastic, plexiglass, PVC and plywood**
- **No-noise**
- HW grade: KCR06 (K01-C4)

Pin holes: PH02= 2/7/42 + 2/9,5/46,5 + 2/10/60

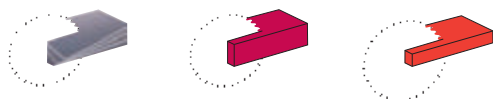

Item	D	d	B/c	Z	Pin holes
MGS250.08030	250	30	2,6/2,0	80	PH02
MGS300.08430	300	30	2,6/2,0	84	PH02
MGS300.09630	300	30	2,6/2,0	96	PH02

HW SAWBLADES FOR FRAMES

ART. MLS - MMS

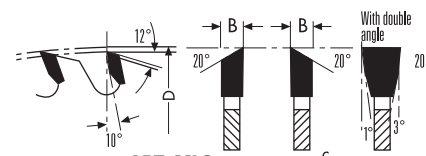

ART. MLS

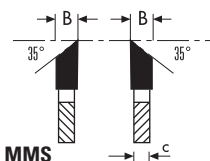

ART. MMS

- WZ alternate top bevel teeth
- Excellent finish on 45° cut
- **No-noise**
- MLS excellent for **MDF and PVC frame**
- MMS for difficult cutting
- HW grade: KCR06 (K01-C4)

Pin holes: PH02= 2/7/42 + 2/9,5/46,5 + 2/10/60

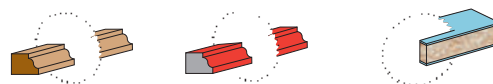

Item	D	d	B/c	α	Z	Pin holes
MLS250.08030	250	30	3,0/2,5	20°	80	PH02
MLS300.09630	300	30	3,0/2,5	20°	96	PH02
MMS300.09630	300	30	3,0/2,5	35°	96	PH02

HW SAWBLADES FOR "SANDWICH" PANELS

ART. MP

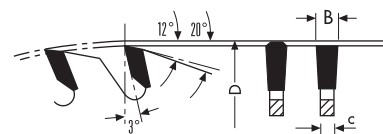

- FZ/TR triple chip teeth
- QHW grade: SMX (P20 - P25 - C6)

Pin holes: PH01= 2/10/60

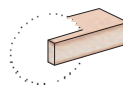

Item	D	d	B/c	Z	Pin holes
MP250.08030 NEW	250	30	2,8/2,2	80	
MP300.09630 NEW	300	30	2,8/2,2	96	PH01
MP350.10830 NEW	350	30	3,2/2,6	108	PH01
MP400.10830 NEW	400	30	3,4/2,8	108	PH01
MP450.12030 NEW	450	30	3,6/3,0	120	
MP500.12040 NEW	500	40	3,8/3,2	120	
MP550.14040 NEW	550	40	4,2/3,6	140	
MP600.14440 NEW	600	40	4,2/3,6	144	

HW DMo5 SAWBLADES FOR FERROUS MATERIALS

ART. PA - PB

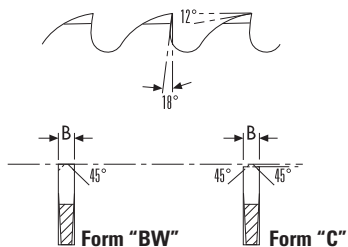

- Vaporized execution for steel, pipe, ferrous materials
- Fit for low RPM table saws
- Art. PA = form "C"
- Art. PB = form "BW"

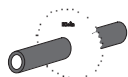

Item	D	d	B	Form	Z	Pin holes
PA225.12032	225	32	2,0	C	120	2/8/45+2/11/63+2/9/50
PA225.12040	225	40	2,0	C	120	2/8/55+4/12/64
PB225.18032	225	32	2,0	BW	180	2/8/45+2/11/63+2/9/50
PB225.18040	225	40	2,0	BW	180	2/8/55+4/12/64
PA250.12832	250	32	2,0	C	128	2/8/45+2/11/63+2/9/50
PA250.12840	250	40	2,0	C	128	2/8/55+4/12/64
PB250.20032	250	32	2,0	BW	200	2/8/45+2/11/63+2/9/50
PB250.20040	250	40	2,0	BW	200	2/8/55+4/12/64
PA275.14032	275	32	2,5	C	140	2/8/45+2/11/63+2/9/50
PA275.14040	275	40	2,5	C	140	2/8/55+4/12/64
PB275.22032	275	32	2,5	BW	220	2/8/45+2/11/63+2/9/50
PB275.22040	275	40	2,5	BW	220	2/8/55+4/12/64
PA300.16032	300	32	2,5	C	160	2/8/45+2/11/63+2/9/50
PA300.16040	300	40	2,5	C	160	2/8/55+4/12/64
PB300.22032	300	32	2,5	BW	220	2/8/45+2/11/63+2/9/50
PB300.22040	300	40	2,5	BW	220	2/8/55+4/12/64
PA315.16032	315	32	2,5	C	160	2/8/45+2/11/63+2/9/50
PA315.16040	315	40	2,5	C	160	2/8/55+4/12/64
PB315.22032	315	32	2,5	BW	220	2/8/45+2/11/63+2/9/50
PB315.22040	315	40	2,5	BW	220	2/8/55+4/12/64
PA325.16040	325	40	2,5	C	160	2/8/55+4/12/64
PA350.18032	350	32	2,5	C	180	2/8/45+2/11/63+2/9/50
PA350.18040	350	40	2,5	C	180	2/8/55+4/12/64
PB350.28032	350	32	2,5	BW	280	2/8/45+2/11/63+2/9/50
PB350.28040	350	40	2,5	BW	280	2/8/55+4/12/64
PA370.19040	370	40	3,0	C	190	2/8/55+4/12/64
PA400.16040	400	40	3,0	C	160	2/8/55+4/12/64

DP SAWBLADES

ART. XFC

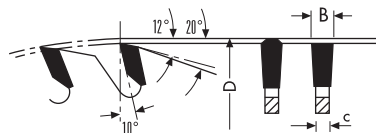

- (FZ/TR) DP triple chip teeth
- For cutting along and across grain of **softwoods, hardwood and exotic timber, double-side veneer laminate boards, MDF and plywood**
- Tooth height **H= 4 mm**

Pin holes: **PH02= 2/7/42 + 2/9,5/46,5 + 2/10/60**

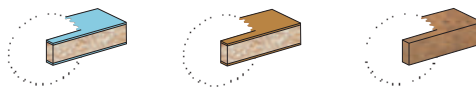

Item	D	d	B/c	Z	Pin holes
XFC250.04830 NEW	250	30	3,2/2,2	48	PH02
XFC250.06030 NEW	250	30	3,2/2,2	60	PH02
XFC300.06030 NEW	300	30	3,2/2,2	60	PH02
XFC300.07230 NEW	300	30	3,2/2,2	72	PH02
XFC350.07230 NEW	350	30	3,5/2,5	72	PH02
XFC350.08430 NEW	350	30	3,5/2,5	84	PH02
XFC350.09630 NEW	350	30	3,5/2,5	96	PH02



DP CONICAL SCORING SAWBLADES

ART. XFI

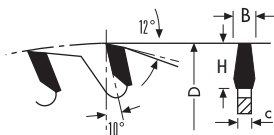

- (KON/FZ) DP conical teeth
- For cutting along and across grain of **softwoods, hardwood and exotic timber, double-side veneer laminate boards, MDF and plywood**
- Tooth height **H= 2,5 mm**

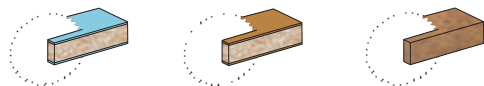

Item	D	d	B/c	Z	Pin holes
XFI120.02020 NEW	120	20	3,1-3,7/2,2	20	
XFI120.02022 NEW	120	22	3,1-3,7/2,2	20	
XFI125.01020 NEW	125	20	2,8-3,4/2,2	10+10	
XFI125.01022 NEW	125	22	2,8-3,4/2,2	10+10	
XFI125.02420 NEW	125	20	3,1-3,7/2,2	20	
XFI125.02422 NEW	125	22	3,1-3,7/2,2	20	
XFI160.03645 NEW	160	45	4,4-5,0/3,2	36	Giben
XFI160.03655 NEW	160	55	4,4-5,0/3,2	36	Gabbiani
XFI180.03620 NEW	180	20	4,4-5,0/3,2	36	
XFI180.03645 NEW	180	45	4,4-5,0/3,2	36	Holzma
XFI180.04450 NEW	180	50	4,4-5,0/3,2	44	Giben
XFI181.03645 NEW	180	45	4,8-5,6/3,5	36	Holzma
XFI182.03620 NEW	180	20	5,8-6,6/4,0	36	Anthon
XFI200.03620 NEW	200	20	4,4-5,0/3,2	36	
XFI200.03630 NEW	200	30	4,4-5,0/3,2	36	
XFI200.03645 NEW	200	45	4,4-5,0/3,2	36	Holzma
XFI200.03665 NEW	200	65	4,4-5,0/3,2	36	Selco
XFI201.03645 NEW	200	45	4,8-5,6/3,5	36	Holzma
XFI201.03665 NEW	200	65	4,8-5,6/3,5	36	Selco
XFI202.03620 NEW	200	20	5,0-5,8/3,5	36	Schelling
XFI203.03645 NEW	200	45	5,8-6,6/4,0	36	Holzma
XFI215.04250 NEW	215	50	4,4-5,0/3,2	42	Giben

DP PANEL SIZING SAWBLADES

ART. XHC

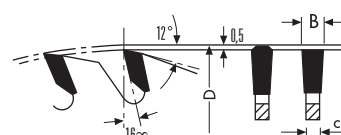

- (FZ/TR) DP triple chip teeth
- For cutting along and across grain of **softwoods, hardwood and exotic timber, double-side veneer laminate boards, MDF and plywood**
- Tooth height **H= 4 mm** (can be produced also with H= 5/6 mm)

Pin holes:

PH02= 2/7/42 + 2/9,5/46,5 + 2/10/60

PH04= 2/14/110 + 2/7/110 + 4/9/100 + 4/19/120 + 2/9/130 (Selco-Gabbiani-SCM)

PH05= 4/15/105 + 3/7/100 (Giben-Homag-MacMazza)

Item	D	d	B/c	Z	Pin holes
XHC300.06030 NEW	300	30	4,4/3,2	60	PH02
XHC300.06065 NEW	300	65	4,4/3,2	60	Selco
XHC320.06050 NEW	320	50	4,4/3,2	60	Giben
XHC320.06065 NEW	320	65	4,4/3,2	60	Selco
XHC330.06050 NEW	330	50	4,4/3,2	60	Giben
XHC350.07230 NEW	350	30	4,4/3,2	72	PH02
XHC350.07250 NEW	350	50	4,4/3,2	72	Giben
XHC350.07260 NEW	350	60	4,4/3,2	72	Holzma
XHC350.07265 NEW	350	65	4,4/3,2	72	Selco
XHC350.07275 NEW	350	75	4,4/3,2	72	PH05
XHC350.07280 NEW	350	80	4,4/3,2	72	PH04
XHC360.07250 NEW	360	50	4,4/3,2	72	Giben
XHC360.07265 NEW	360	65	4,4/3,2	72	Selco
XHC370.07230 NEW	370	30	4,4/3,2	72	PH02
XHC380.07260 NEW	380	60	4,8/3,5	72	Holzma
XHC400.07230 NEW	400	30	4,4/3,2	72	2/10/60
XHC400.07260 NEW	400	60	4,4/3,2	72	Anthon
XHC400.07275 NEW	400	75	4,4/3,2	72	Giben-Homag
XHC400.07280 NEW	400	80	4,4/3,2	72	PH04
XHC401.07260 NEW	400	60	4,8/3,5	72	Holzma
XHC420.07260 NEW	420	60	4,8/3,5	72	Holzma
XHC430.07275 NEW	430	75	4,8/3,5	72	Giben
XHC430.07280 NEW	430	80	4,8/3,5	72	PH04
XHC450.07230 NEW	450	30	4,8/3,5	72	Schelling
XHC450.07280 NEW	450	80	4,8/3,5	72	PH04
XHC451.07260 NEW	450	60	4,8/3,5	72	Holzma
XHC451.07280 NEW	450	80	4,8/3,5	72	PH04
XHC460.07230 NEW	460	30	4,4/3,2	72	Schelling
XHC470.07275 NEW	470	75	4,4/3,2	72	Giben
XHC480.07230 NEW	480	30	4,4/3,2	72	Schelling
XHC481.07260 NEW	480	60	4,8/3,5	72	Holzma
XHC481.07280 NEW	480	80	4,8/3,5	72	Selco
XHC500.07260 NEW	500	60	4,8/3,5	72	Holzma
XHC520.07260 NEW	520	60	4,8/3,5	60	Holzma

REDUCTION RINGS FOR SAWBLADES

ART. ZA

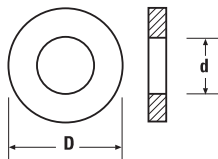

Item	D	d
ZA000.02012	20	12,7
ZA000.02014 <i>selling out</i>	20	13
ZA000.02015 <i>selling out</i>	20	15
ZA000.02016	20	16
ZA000.03015 <i>selling out</i>	30	15
ZA000.03016	30	16
ZA000.03020	30	20
ZA000.03025	30	25
ZA000.03026	30	25,4
ZA000.03028 <i>selling out</i>	30	28,6
ZA000.03220 NEW	32	20
ZA000.03230	32	30
ZA000.03516 NEW	35	16
ZA000.03520 NEW	35	20
ZA000.03526 NEW	35	26
ZA000.03530	35	30
ZA000.03532 NEW	35	32
ZA000.04030 NEW	40	30
ZA000.04032 NEW	40	32
ZA000.04035 NEW	40	35

SPECIAL SAWBLADE REBORING

ART. AF

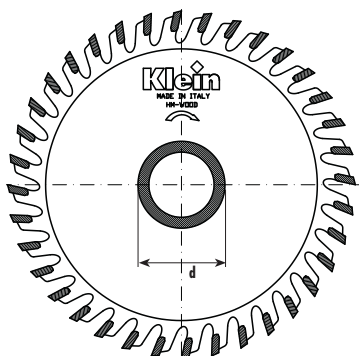

- Specify diameter (d)
- **Reboring is never recommended**
- **Maximum reboring of the blade is 20 mm of the original bore size**

Item	pcs.
LAME.AF.x1	1
LAME.AF.x2	2
LAME.AF.x3	3

SAFETY PIN HOLES FOR SAWBLADES

ART. FT

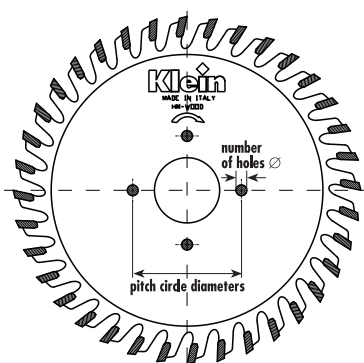

Specify number of pin holes, sawblade diameter and pitch circle diameters

Item	pcs.
LAME.FT.x1	1
LAME.FT.x2	2
LAME.FT.x3	3

Cutterheads



13



HW "LAMELLO"- GROOVE CUTTER
Page 13.03



HW "LAMELLO"- GROOVE CUTTER
Page 13.03



HW ADJUSTABLE GROOVE CUTTER
Page 13.03



HS CUTTERHEADS B=40
WITH CHIP LIMITERS
Page 13.04



HS CUTTERHEADS B=40
WITHOUT CHIP LIMITERS
Page 13.04



LIGHT ALLOY CUTTERHEADS
B=40-50 WITH CHIP LIMITERS
Page 13.05



LIGHT ALLOY CUTTERHEADS B=40-50
WITHOUT CHIP LIMITERS
Page 13.05



7 PROFILE CUTTERHEAD SETS WITH
KNIVES AND CHIP LIMITERS
(PROFILES 0-6)
Page 13.06



7 PROFILE CUTTERHEAD SETS
WITH KNIVES (PROFILES 0-6)
Page 13.06



13 PROFILE CUTTERHEAD SETS WITH
KNIVES AND CHIP LIMITERS
(PROFILES 0-12)
Page 13.07



13 PROFILE CUTTERHEAD SETS
WITH KNIVES (PROFILES 0-12)
Page 13.07



13 PROFILE CUTTERHEAD SETS
WITH KNIVES AND CHIP LIMITERS
(PROFILES 13-24)
Page 13.08



13 PROFILE CUTTERHEAD SETS
WITH KNIVES (PROFILES 13-24)
Page 13.08



13 PROFILE CUTTERHEAD SETS WITH
KNIVES AND CHIP LIMITERS
(PROFILES 25-36)
Page 13.09



13 PROFILE CUTTERHEAD SETS
WITH KNIVES (PROFILES 25-36)
Page 13.09



HW ADJUSTABLE CUTTERHEAD WITH
REVERSIBLE KNIVES FOR GROOVES
Page 13.21



HW CUTTERHEADS WITH REVERSIBLE
KNIVES FOR "LAMELLO"
Page 13.22



HW ADJUSTABLE CUTTERHEAD WITH
REVERSIBLE KNIVES FOR GROOVES
Page 13.22





HW ADJUSTABLE GROOVING CUTTERHEAD FOR TENONS
Page 13.23



HW CUTTERHEAD WITH REVERSIBLE STRAIGHT KNIVES AND SPURS
Page 13.23



HW CUTTERHEAD WITH REVERSIBLE STRAIGHT KNIVES AND SPURS
Page 13.24



REBATING-GROOVING SET
Page 13.25



HW CUTTERHEAD FOR 45° BEVELS
Page 13.25



HW ADJUSTABLE BEVEL CUTTERHEAD
Page 13.26



HW TOOLING SET FOR ROUNDING AND CHAMFERING
Page 13.27



HW MULTIRADIUS SET
Page 13.28



HW TOOLING SET FOR CONCAVE AND CONVEX QUARTER ROUNDS
Page 13.29



MULTIPROFILE SET
Page 13.30



HW MITRE JOINT CUTTERHEAD 45°
Page 13.34



HW PROFILE CUTTER
Page 13.34



HW PANEL RAISING SET WITH SIX PROFILES
Page 13.35 - 13.36



HW PROFILE-COUNTERPROFILE PANEL RAISING CUTTERHEAD
Page 13.37



HW PANEL RAISING SET
Page 13.38



HW PANEL RAISING SET
Page 13.39



COUNTERPROFILE-RAISING PANEL SET
Page 13.39

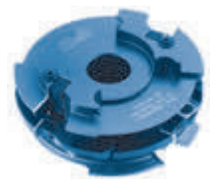

HW TOOLING SET FOR PROFILES AND COUNTERPROFILES
Page 13.40 ÷ 13.42



TONGUE AND GROOVE TOOLING SET
Page 13.43



HW PLANERHEAD
Page 13.44



GUIDE BALL BEARINGS FOR SAWING OUT
Page 13.44



GUIDE RINGS FOR BALL BEARING
Page 13.44

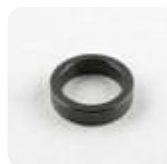

REDUCTION RINGS FOR CUTTERHEADS
Page 13.45



REDUCING BUSHES
Page 13.45



BALL BEARING WITH BUTTING RING SET
Page 13.45

HW "LAMELLO"- GROOVE CUTTER

ART. AH

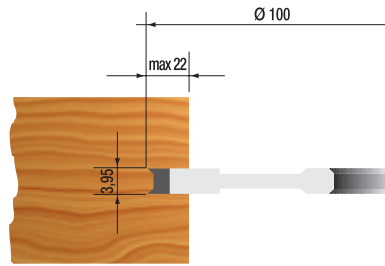

- T.C.T. brazed cutter with spurs for making grooves on any kind of wood
- For hand milling machines

Item	D	d	B	Z	V
AH100.20622	100	22	3,95	2	4

HW "LAMELLO"- GROOVE CUTTER

ART. RA

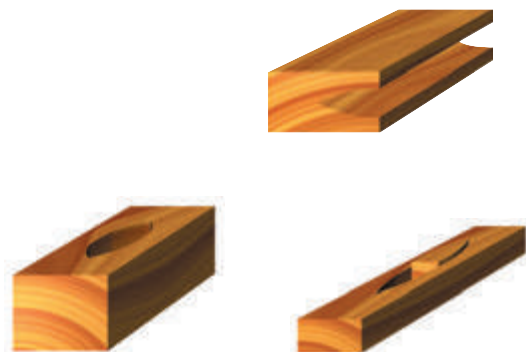
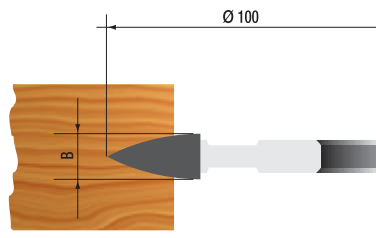

T.C.T. brazed cutters for manual feed for lamello hand milling machines

Item	D	d	B	Z
RA100.08022	100	22	8	4
RA100.15022	100	22	15	4

HW ADJUSTABLE GROOVE CUTTER

ART. RA

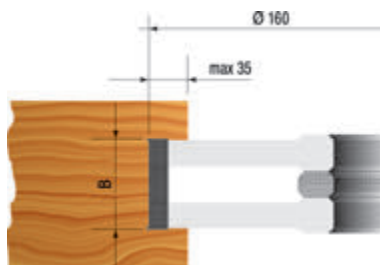

T.C.T. brazed cutter with spurs for precision grooves for manual feed

Item	D	d	B	Z	V
RA160.07530	160	30	4÷7,5	4	4
RA160.14030	160	30	7,5÷14	4	4

HS CUTTERHEADS B=40 WITH CHIP LIMITERS

ART. SA

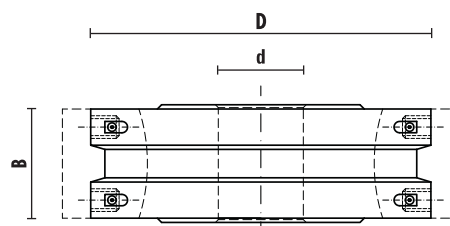

- Tool body in steel
- Equipped with SP knives and chip limiters profile "0"
- For spindle moulders with manual feed (MAN)
- To be used with knives **B=40x4 mm** (Art. SA0 page 13.08÷13.13) and chip limiters (Art. SA1 page 13.08÷13.13)
- For solid wood

Item	D	d	B	Z	n min	n max
SA078.40030 NEW	78	30	40	2	7000	9000
SA093.40030	93	30	40	2	5800	8600
SA100.40030 NEW	100	30	40	2	5500	8400
SA120.40030 NEW	120	30	40	2	4800	7700
SA120.40035	120	35	40	2	4800	7700
SA120.40050 NEW	120	50	40	2	4800	7700



Z056.790.R



Z051.704.R



Z052.003.R

HS CUTTERHEADS B=40 WITHOUT CHIP LIMITERS

ART. SA

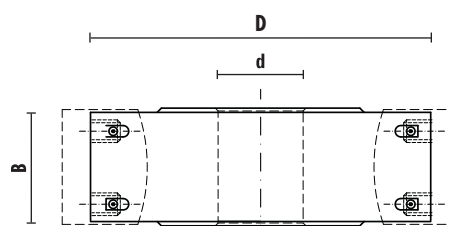

- Tool body in steel
- Equipped with SP knives profile "0"
- For spindle moulders with mechanical feed (MEC)
- To be used with knives **B=40x4 mm** (Art. SA0 page 13.08÷13.13)

Item	D	d	B	Z	n min	n max
SA078.40130 NEW	78	30	40	2	7000	9000
SA093.40130 NEW	93	30	40	2	5800	8600
SA100.40130 NEW	100	30	40	2	5500	8400
SA120.40135 NEW	120	35	40	2	4800	7700
SA120.40150 NEW	120	50	40	2	4800	7700



Z056.791.R



Z051.705.R



Z052.003.R

LIGHT ALLOY CUTTERHEADS B=40÷50 WITH CHIP LIMITERS

ART. SAL

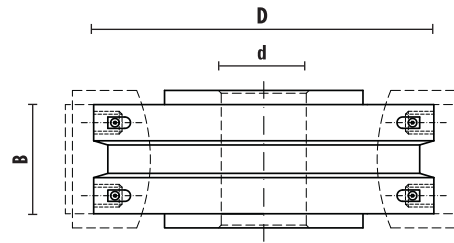

- Tool body in light alloy
- Equipped with SP knives and chip limiters profile "0"
- For spindle moulders with manual feed (MAN)
- To be used with knives **B=40x4 mm** (Art. SA0 page 13.08÷13.13) and chip limiters (Art. SA1 page 13.08÷13.13) or **B=50x4 mm** (Art. SA2 page 13.14÷13.18) and chip limiters (Art. SA3 page 13.14÷13.18)

Item	D	d	B	Z	n min	n max
SAL100.45030 NEW	100	30	40÷50	2	5500	8400
SAL120.45035 NEW	120	35	40÷50	2	4800	7400
SAL120.45050 NEW	120	50	40÷50	2	4800	7400



LIGHT ALLOY CUTTERHEADS B=40÷50 WITHOUT CHIP LIMITERS

ART. SAL

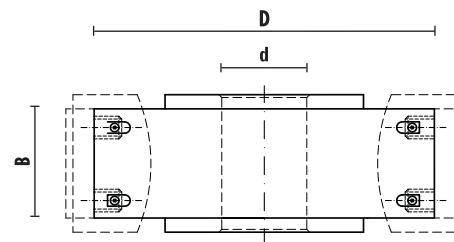

- Tool body in light alloy
- Equipped with SP knives and chip limiters profile "0"
- For spindle moulders with mechanical feed (MEC)
- To be used with knives **B=40x4 mm** (Art. SA0 page 13.08÷13.13) or **B=50x4 mm** (Art. SA2 page 13.14÷13.18)

Item	D	d	B	Z	n min	n max
SAL100.45130 NEW	100	30	40÷50	2	5500	8400
SAL120.45135 NEW	120	35	40÷50	2	4800	7400
SAL120.45150 NEW	120	50	40÷50	2	4800	7400



7 PROFILE CUTTERHEAD SETS WITH KNIVES AND CHIP LIMITERS (PROFILES 0÷6)

ART. SX001 - SXL001

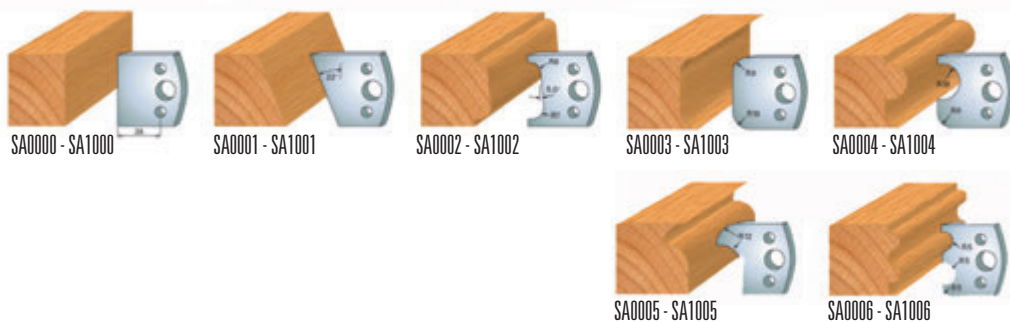

- Set in plastic box complete with cutterhead, SP steel knives and chip limiters profiles 0÷6
- Cutterhead Z=2 tool body in steel (**Art. SX**)
- Cutterhead Z=2 tool body in light alloy (**Art. SXL**)
- For spindle moulders with manual feed (MAN)

Item

SX001.078.40030 NEW	Complete with cutterhead in steel body D=78 - Bore 30 - B=40 (Art. SA078.40030) + Profiles and chip limiters 0÷6
SX001.093.40030 NEW	Complete with cutterhead in steel body D=93 - Bore 30 - B=40 (Art. SA093.40030) + Profiles and chip limiters 0÷6
SX001.100.40030 NEW	Complete with cutterhead in steel body D=100 - Bore 30 - B=40 (Art. SA100.40030) + Profiles and chip limiters 0÷6
SX001.120.40035 NEW	Complete with cutterhead in steel body D=120 - Bore 35 - B=40 (Art. SA120.40030) + Profiles and chip limiters 0÷6
SX001.120.40050 NEW	Complete with cutterhead in steel body D=120 - Bore 50 - B=40 (Art. SA120.40050) + Profiles and chip limiters 0÷6
SXL001.100.45030 NEW	Complete with cutterhead in light alloy body D=100 - Bore 30 - B=40÷50 (Art. SAL100.45030) + Profiles and chip limiters 0÷6
SXL001.120.45035 NEW	Complete with cutterhead in light alloy body D=120 - Bore 35 - B=40÷50 (Art. SAL120.45030) + Profiles and chip limiters 0÷6
SXL001.120.45050 NEW	Complete with cutterhead in light alloy body D=120 - Bore 50 - B=40÷50 (Art. SAL120.45050) + Profiles and chip limiters 0÷6

7 PROFILE CUTTERHEAD SETS WITH KNIVES (PROFILES 0÷6)

ART. SX001 - SXL001

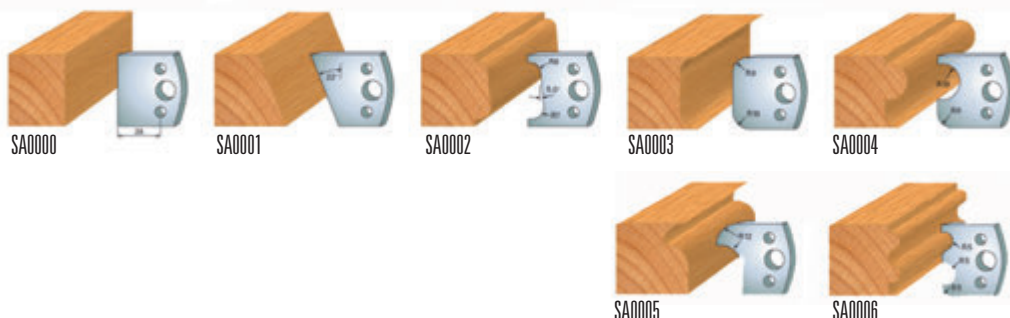

- Set in plastic box complete with cutterheads and SP steel knives 0÷6 (without chip limiters)
- Cutterhead Z=2 tool body in steel (**Art. SX**)
- Cutterhead Z=2 tool body in light alloy (**Art. SXL**)
- For spindle moulders with mechanical feed (MEC)

Item

SX001.078.40130 NEW	Complete with cutterhead in steel body D=78 - Bore 30 - B=40 (Art. SA078.40030) + Profiles 0÷6
SX001.093.40130 NEW	Complete with cutterhead in steel body D=93 - Bore 30 - B=40 (Art. SA093.40030) + Profiles 0÷6
SX001.100.40130 NEW	Complete with cutterhead in steel body D=100 - Bore 30 - B=40 (Art. SA100.40030) + Profiles 0÷6
SX001.120.40135 NEW	Complete with cutterhead in steel body D=120 - Bore 35 - B=40 (Art. SA120.40030) + Profiles 0÷6
SX001.120.40150 NEW	Complete with cutterhead in steel body D=120 - Bore 50 - B=40 (Art. SA120.40050) + Profiles 0÷6
SXL001.100.45130 NEW	Complete with cutterhead in light alloy body D=100 - Bore 30 - B=40÷50 (Art. SAL100.45030) + Profiles 0÷6
SXL001.120.45135 NEW	Complete with cutterhead in light alloy body D=120 - Bore 35 - B=40÷50 (Art. SAL120.45030) + Profiles 0÷6
SXL001.120.45150 NEW	Complete with cutterhead in light alloy body D=120 - Bore 50 - B=40÷50 (Art. SAL120.45050) + Profiles 0÷6

13 PROFILE CUTTERHEAD SETS WITH KNIVES AND CHIP LIMITERS (PROFILES 0÷12)

ART. SX002 - SXL002

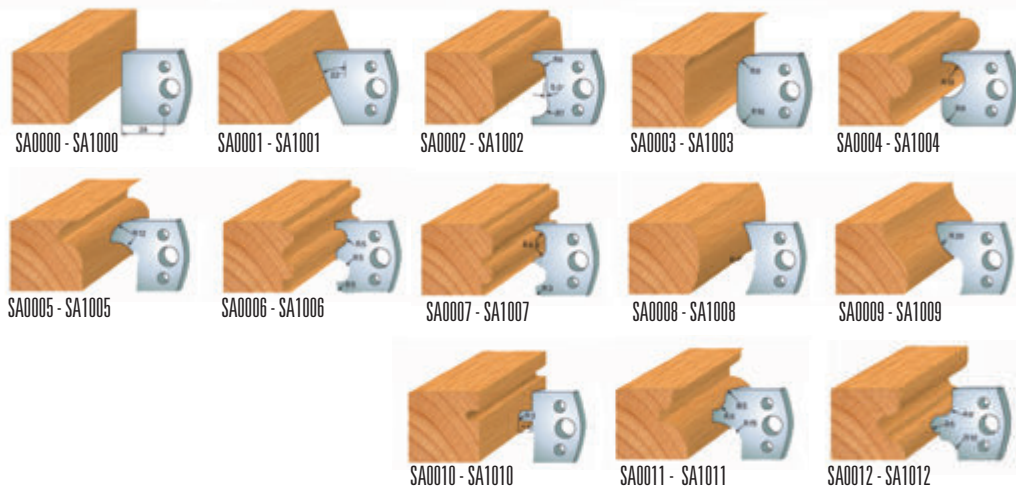

- Set in plastic box complete with cutterheads, SP steel knives and chip limiters profile 0÷12
- Cutterhead Z=2 tool body in steel (**Art. SX**)
- Cutterhead Z=2 tool body in light alloy (**Art. SXL**)
- For spindle moulders with manual feed (MAN)

Item	Description
SX002.078.40030 NEW	Complete with cutterhead in steel body D=78 - Bore 30 - B=40 (Art. SA078.40030) + Profiles and chip limiters 0÷12
SX002.093.40030 NEW	Complete with cutterhead in steel body D=93 - Bore 30 - B=40 (Art. SA093.40030) + Profiles and chip limiters 0÷12
SX002.100.40030 NEW	Complete with cutterhead in steel body D=100 - Bore 30 - B=40 (Art. SA100.40030) + Profiles and chip limiters 0÷12
SX002.120.40035 NEW	Complete with cutterhead in steel body D=120 - Bore 35 - B=40 (Art. SA120.40030) + Profiles and chip limiters 0÷12
SX002.120.40050 NEW	Complete with cutterhead in steel body D=120 - Bore 50 - B=40 (Art. SA120.40050) + Profiles and chip limiters 0÷12
SXL002.100.45030 NEW	Complete with cutterhead in light alloy body D=100 - Bore 30 - B=40÷50 (Art. SAL100.45030) + Profiles and chip limiters 0÷12
SXL002.120.45035 NEW	Complete with cutterhead in light alloy body D=120 - Bore 35 - B=40÷50 (Art. SAL120.45030) + Profiles and chip limiters 0÷12
SXL002.120.45050 NEW	Complete with cutterhead in light alloy body D=120 - Bore 50 - B=40÷50 (Art. SAL120.45050) + Profiles and chip limiters 0÷12

13 PROFILE CUTTERHEAD SETS WITH KNIVES (PROFILES 0÷12)

ART. SX002 - SXL002

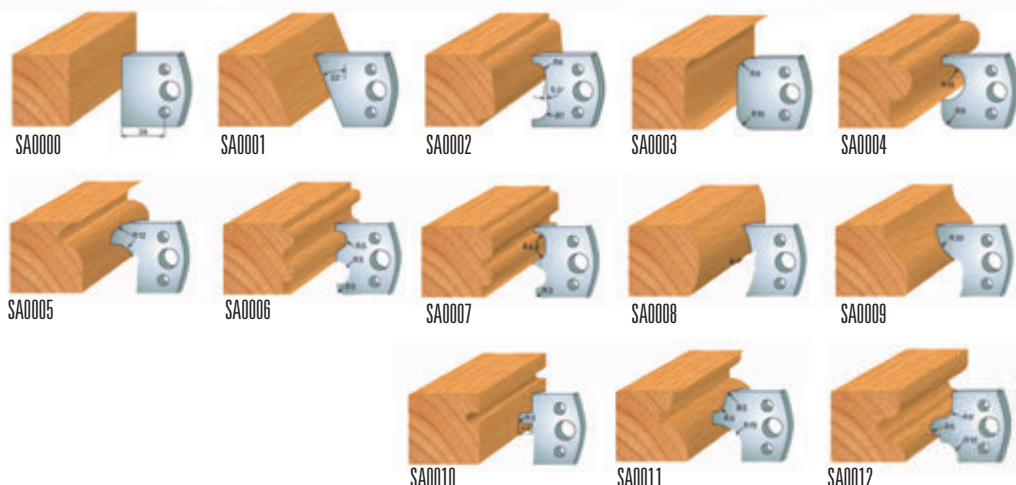

- Set in plastic box complete with cutterheads and SP steel knives 0÷12 (without chip limiters)
- Cutterhead Z=2 tool body in steel (**Art. SX**)
- Cutterhead Z=2 tool body in light alloy (**Art. SXL**)
- For spindle moulders with mechanical feed (MEC)

Item	Description
SX002.078.40130 NEW	Complete with cutterhead in steel body D=78 - Bore 30 - B=40 (Art. SA078.40030) + Profiles 0÷12
SX002.093.40130 NEW	Complete with cutterhead in steel body D=93 - Bore 30 - B=40 (Art. SA093.40030) + Profiles 0÷12
SX002.100.40130 NEW	Complete with cutterhead in steel body D=100 - Bore 30 - B=40 (Art. SA100.40030) + Profiles 0÷12
SX002.120.40135 NEW	Complete with cutterhead in steel body D=120 - Bore 35 - B=40 (Art. SA120.40030) + Profiles 0÷12
SX002.120.40150 NEW	Complete with cutterhead in steel body D=120 - Bore 50 - B=40 (Art. SA120.40050) + Profiles 0÷12
SXL002.100.45130 NEW	Complete with cutterhead in light alloy body D=100 - Bore 30 - B=40÷50 (Art. SAL100.45030) + Profiles 0÷12
SXL002.120.45135 NEW	Complete with cutterhead in light alloy body D=120 - Bore 35 - B=40÷50 (Art. SAL120.45030) + Profiles 0÷12
SXL002.120.45150 NEW	Complete with cutterhead in light alloy body D=120 - Bore 50 - B=40÷50 (Art. SAL120.45050) + Profiles 0÷12

13 PROFILE CUTTERHEAD SETS WITH KNIVES AND CHIP LIMITERS (PROFILES 13÷24)

ART. SX003 - SXL003

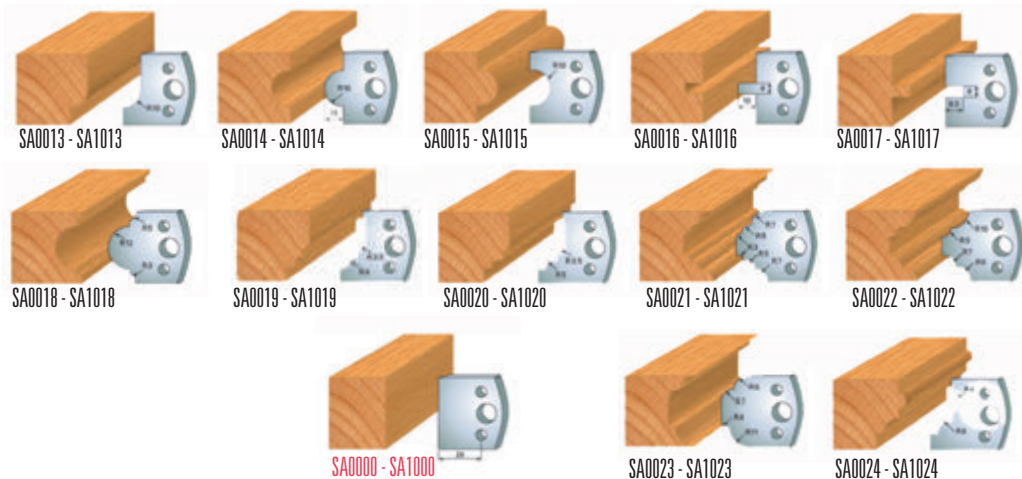

- Set in plastic box complete with cutterheads, SP steel knives and chip limiters profile 0+13÷24
- Cutterhead Z=2 tool body in steel (**Art. SX**)
- Cutterhead Z=2 tool body in light alloy (**Art. SXL**)
- For spindle moulders with manual feed (MAN)

Item	Description
SX003.078.40030 NEW	Complete with cutterhead in steel body D=78 - Bore 30 - B=40 (Art. SA078.40030) + Profiles and chip limiters 13÷24
SX003.093.40030 NEW	Complete with cutterhead in steel body D=93 - Bore 30 - B=40 (Art. SA093.40030) + Profiles and chip limiters 13÷24
SX003.100.40030 NEW	Complete with cutterhead in steel body D=100 - Bore 30 - B=40 (Art. SA100.40030) + Profiles and chip limiters 13÷24
SX003.120.40035 NEW	Complete with cutterhead in steel body D=120 - Bore 35 - B=40 (Art. SA120.40030) + Profiles and chip limiters 13÷24
SX003.120.40050 NEW	Complete with cutterhead in steel body D=120 - Bore 50 - B=40 (Art. SA120.40050) + Profiles and chip limiters 13÷24
SXL003.100.45030 NEW	Complete with cutterhead in light alloy body D=100 - Bore 30 - B=40÷50 (Art. SAL100.45030) + Profiles and chip limiters 13÷24
SXL003.120.45035 NEW	Complete with cutterhead in light alloy body D=120 - Bore 35 - B=40÷50 (Art. SAL120.45030) + Profiles and chip limiters 13÷24
SXL003.120.45050 NEW	Complete with cutterhead in light alloy body D=120 - Bore 50 - B=40÷50 (Art. SAL120.45050) + Profiles and chip limiters 13÷24

13 PROFILE CUTTERHEAD SETS WITH KNIVES (PROFILES 13÷24)

ART. SX003 - SXL003

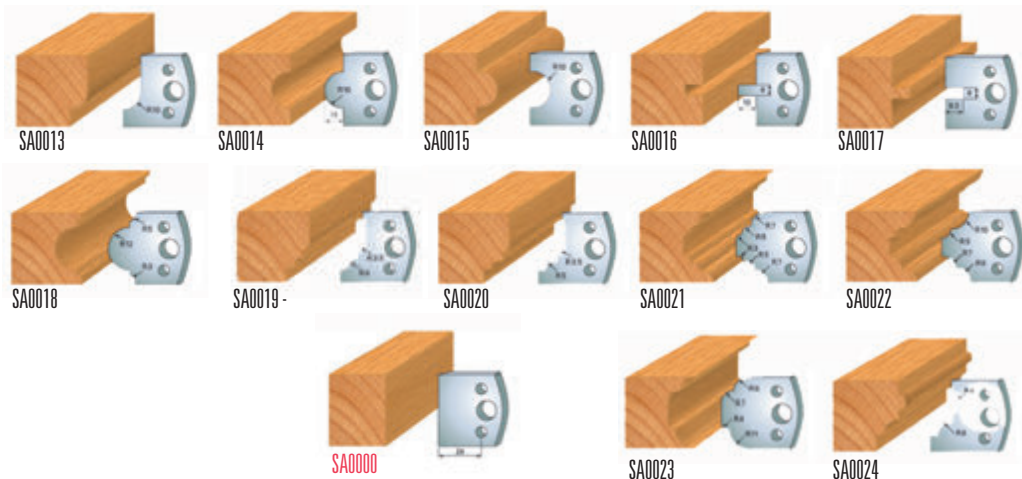

- Set in plastic box complete with cutterheads and SP steel knives 0+13÷24 (without chip limiters)
- Cutterhead Z=2 tool body in steel (**Art. SX**)
- Cutterhead Z=2 tool body in light alloy (**Art. SXL**)
- For spindle moulders with mechanical feed (MEC)

Item	Description
SX003.078.40130 NEW	Complete with cutterhead in steel body D=78 - Bore 30 - B=40 (Art. SA078.40030) + Profiles 13÷24
SX003.093.40130 NEW	Complete with cutterhead in steel body D=93 - Bore 30 - B=40 (Art. SA093.40030) + Profiles 13÷24
SX003.100.40130 NEW	Complete with cutterhead in steel body D=100 - Bore 30 - B=40 (Art. SA100.40030) + Profiles 13÷24
SX003.120.40135 NEW	Complete with cutterhead in steel body D=120 - Bore 35 - B=40 (Art. SA120.40030) + Profiles 13÷24
SX003.120.40150 NEW	Complete with cutterhead in steel body D=120 - Bore 50 - B=40 (Art. SA120.40050) + Profiles 13÷24
SXL003.100.45130 NEW	Complete with cutterhead in light alloy body D=100 - Bore 30 - B=40÷50 (Art. SAL100.45030) + Profiles 13÷24
SXL003.120.45135 NEW	Complete with cutterhead in light alloy body D=120 - Bore 35 - B=40÷50 (Art. SAL120.45030) + Profiles 13÷24
SXL003.120.45150 NEW	Complete with cutterhead in light alloy body D=120 - Bore 50 - B=40÷50 (Art. SAL120.45050) + Profiles 13÷24

13 PROFILE CUTTERHEAD SETS WITH KNIVES AND CHIP LIMITERS (PROFILES 25÷36)

ART. SX004 - SXL004

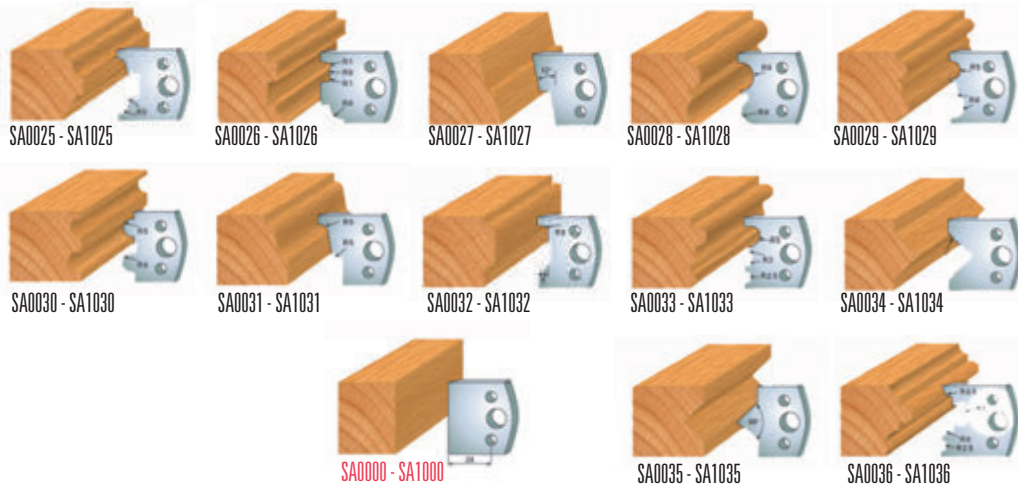

- Set in plastic box complete with cutterheads, SP steel knives and chip limiters profile 0+25÷36
- Cutterhead Z=2 tool body in steel (Art. SX)
- Cutterhead Z=2 tool body in light alloy (Art. SXL)
- For spindle moulders with manual feed (MAN)

Item	Description
SX004.078.40030 NEW	Complete with cutterhead in steel body D=78 - Bore 30 - B=40 (Art. SA078.40030) + Profiles and chip limiters 25÷36
SX004.093.40030 NEW	Complete with cutterhead in steel body D=93 - Bore 30 - B=40 (Art. SA093.40030) + Profiles and chip limiters 25÷36
SX004.100.40030 NEW	Complete with cutterhead in steel body D=100 - Bore 30 - B=40 (Art. SA100.40030) + Profiles and chip limiters 25÷36
SX004.120.40035 NEW	Complete with cutterhead in steel body D=120 - Bore 35 - B=40 (Art. SA120.40030) + Profiles and chip limiters 25÷36
SX004.120.40050 NEW	Complete with cutterhead in steel body D=120 - Bore 50 - B=40 (Art. SA120.40050) + Profiles and chip limiters 25÷36
SXL004.100.45030 NEW	Complete with cutterhead in light alloy body D=100 - Bore 30 - B=40÷50 (Art. SAL100.45030) + Profiles and chip limiters 25÷36
SXL004.120.45035 NEW	Complete with cutterhead in light alloy body D=120 - Bore 35 - B=40÷50 (Art. SAL120.45030) + Profiles and chip limiters 25÷36
SXL004.120.45050 NEW	Complete with cutterhead in light alloy body D=120 - Bore 50 - B=40÷50 (Art. SAL120.45050) + Profiles and chip limiters 25÷36

13 PROFILE CUTTERHEAD SETS WITH KNIVES (PROFILES 25÷36)

ART. SX004 - SXL004

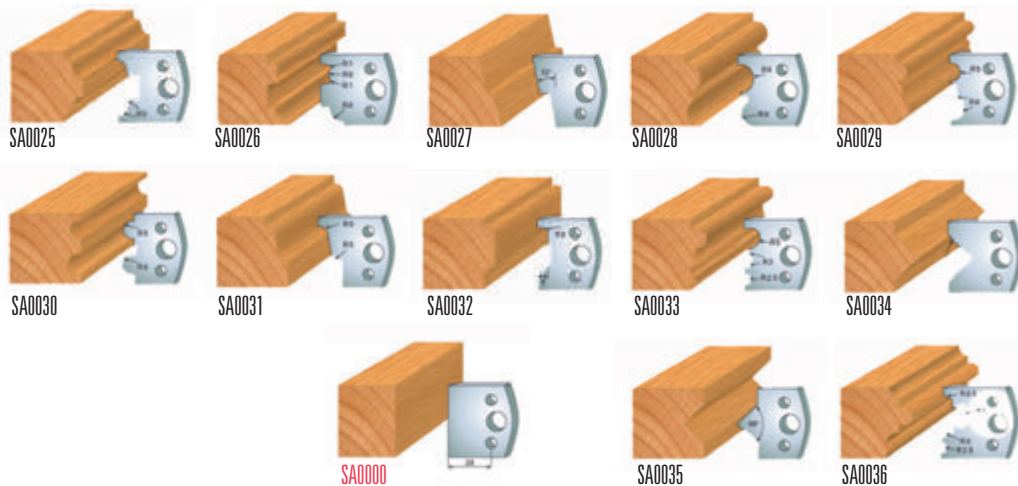

- Set in plastic box complete with cutterheads and SP steel knives 0+25÷36 (without chip limiters)
- Cutterhead Z=2 tool body in steel (Art. SX)
- Cutterhead Z=2 tool body in light alloy (Art. SXL)
- For spindle moulders with mechanical feed (MEC)

Item	Description
SX004.078.40130 NEW	Complete with cutterhead in steel body D=78 - Bore 30 - B=40 (Art. SA078.40030) + Profiles 25÷36
SX004.093.40130 NEW	Complete with cutterhead in steel body D=93 - Bore 30 - B=40 (Art. SA093.40030) + Profiles 25÷36
SX004.100.40130 NEW	Complete with cutterhead in steel body D=100 - Bore 30 - B=40 (Art. SA100.40030) + Profiles 25÷36
SX004.120.40135 NEW	Complete with cutterhead in steel body D=120 - Bore 35 - B=40 (Art. SA120.40030) + Profiles 25÷36
SX004.120.40150 NEW	Complete with cutterhead in steel body D=120 - Bore 50 - B=40 (Art. SA120.40050) + Profiles 25÷36
SXL004.100.45130 NEW	Complete with cutterhead in light alloy body D=100 - Bore 30 - B=40÷50 (Art. SAL100.45030) + Profiles 25÷36
SXL004.120.45135 NEW	Complete with cutterhead in light alloy body D=120 - Bore 35 - B=40÷50 (Art. SAL120.45030) + Profiles 25÷36
SXL004.120.45150 NEW	Complete with cutterhead in light alloy body D=120 - Bore 50 - B=40÷50 (Art. SAL120.45050) + Profiles 25÷36

**STANDARD PROFILE KNIVES IN "SP" STEEL - height 40x4 mm
(RELATING LIMITERS)**

**Example:
Knife SA0..
Limiter (SA1..)**

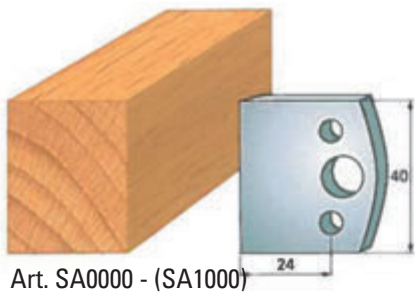

Art. SA0000 - (SA1000)

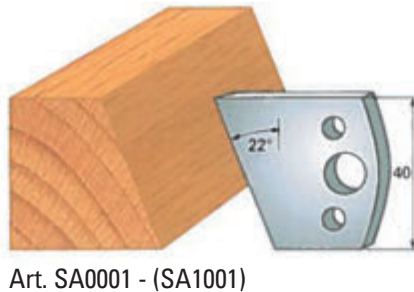

Art. SA0001 - (SA1001)

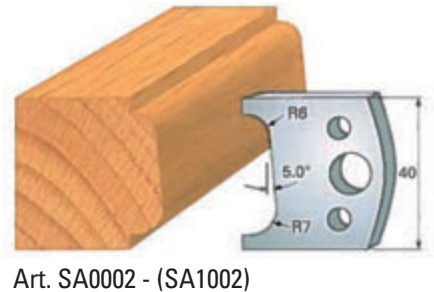

Art. SA0002 - (SA1002)

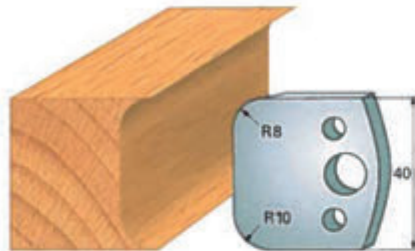

Art. SA0003 - (SA1003)

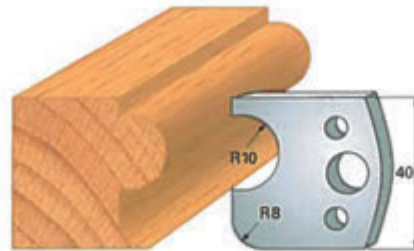

Art. SA0004 - (SA1004)



Art. SA0005 - (SA1005)

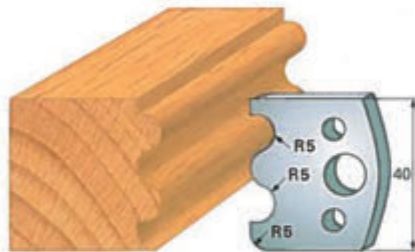

Art. SA0006 - (SA1006)

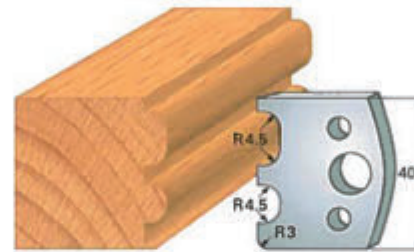

Art. SA0007 - (SA1007)

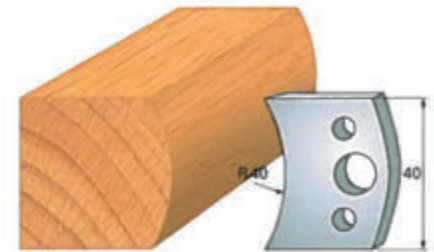

Art. SA0008 - (SA1008)

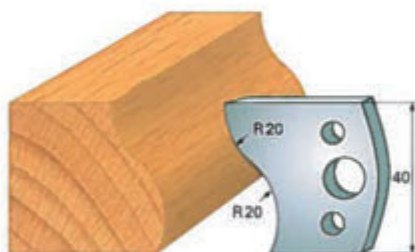

Art. SA0009 - (SA1009)

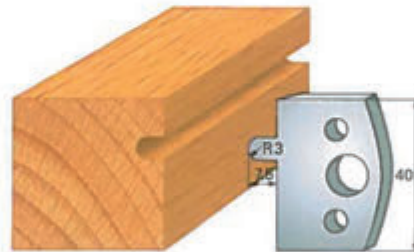

Art. SA0010 - (SA1010)

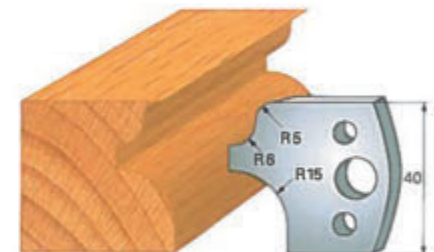

Art. SA0011 - (SA1011)

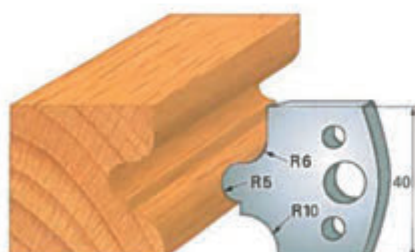

Art. SA0012 - (SA1012)

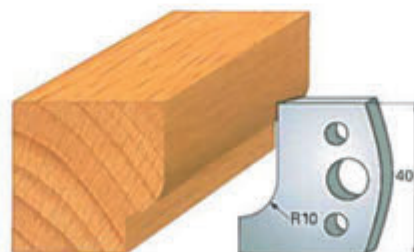

Art. SA0013 - (SA1013)

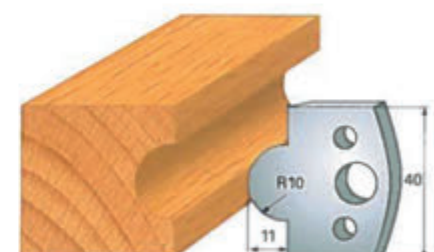

Art. SA0014 - (SA1014)



Art. SA0015 - (SA1015)

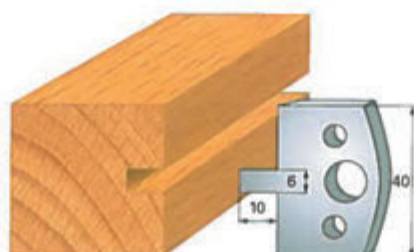

Art. SA0016 - (SA1016)



Art. SA0017 - (SA1017)

**STANDARD PROFILE KNIVES IN "SP" STEEL - height 40x4 mm
(RELATING LIMITERS)**

**Example:
Knife SA0..
Limiter (SA1..)**

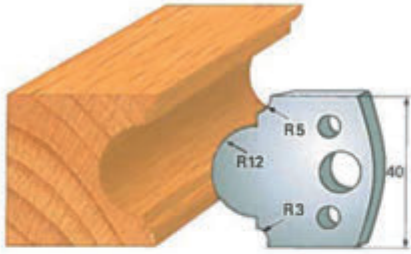

Art. SA0018 - (SA1018)

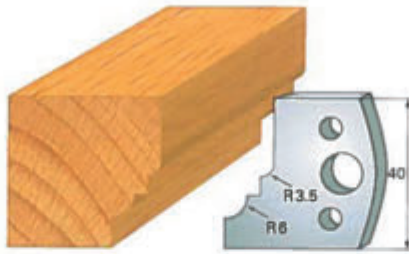

Art. SA0019 - (SA1019)

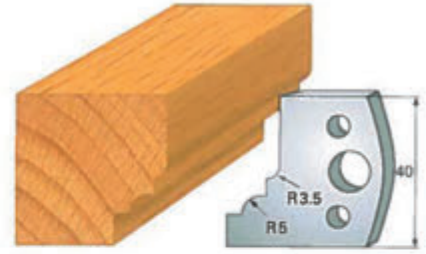

Art. SA0020 - (SA1020)

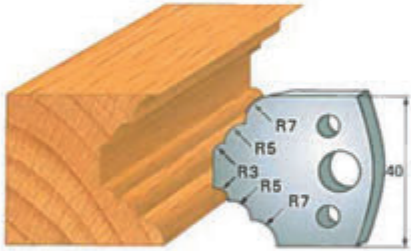

Art. SA0021 - (SA1021)

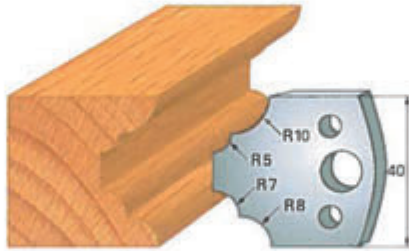

Art. SA0022 - (SA1022)

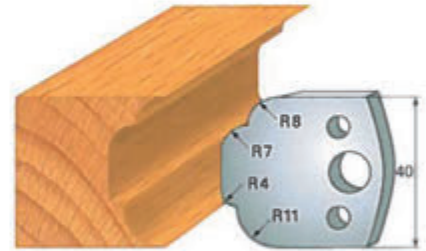

Art. SA0023 - (SA1023)

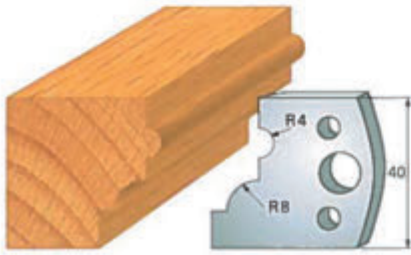

Art. SA0024 - (SA1024)

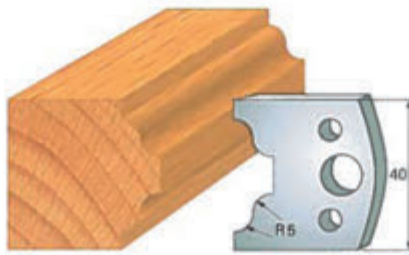

Art. SA0025 - (SA1025)

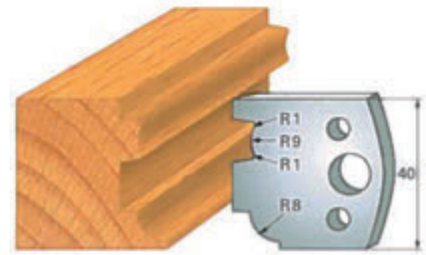

SA0026 - (SA1026)



Art. SA0027 - (SA1027)



Art. SA0028 - (SA1028)

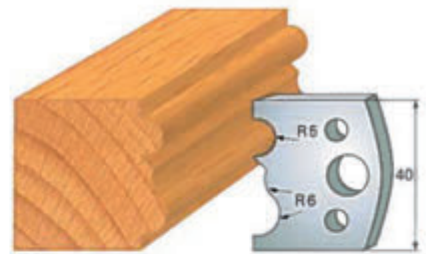

Art. SA0029 - (SA1029)

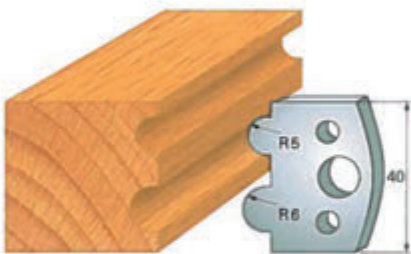

Art. SA0030 - (SA1030)

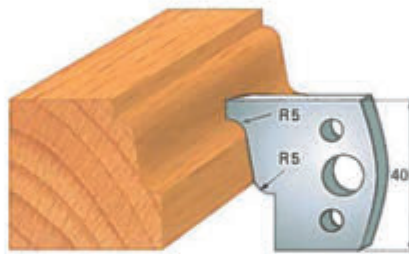

Art. SA0031 - (SA1031)

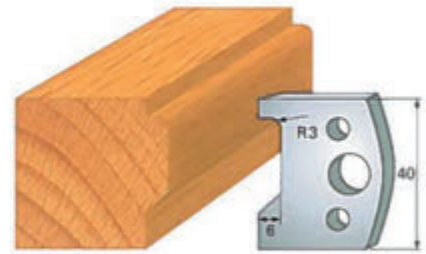

Art. SA0032 - (SA1032)

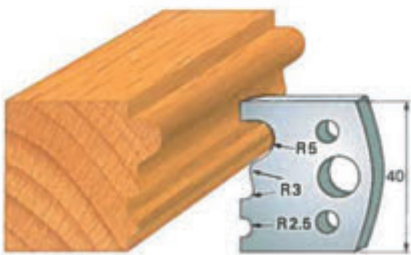

Art. SA0033 - (SA1033)

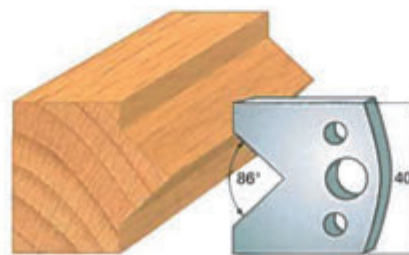

Art. SA0034 - (SA1034)

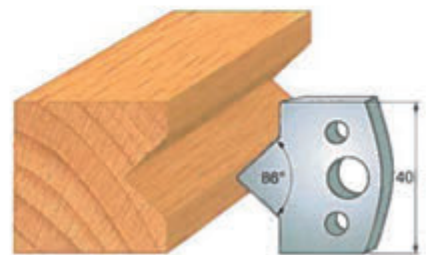

Art. SA0035 - (SA1035)

**STANDARD PROFILE KNIVES IN "SP" STEEL - height 40x4 mm
(RELATING LIMITERS)**

**Example:
Knife SA0..
Limiter (SA1..)**

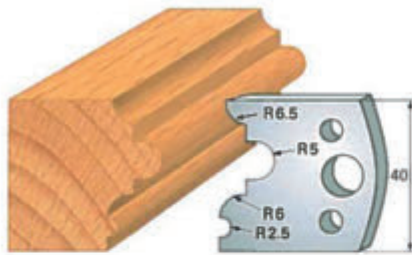

Art. SA0036 - (SA1036)

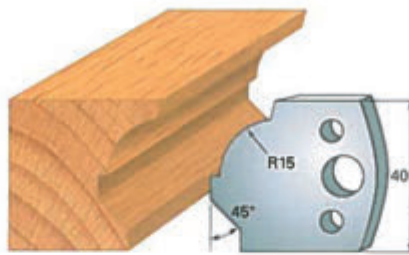

Art. SA0037 - (SA1037)

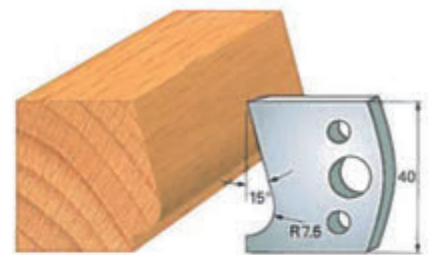

Art. SA0038 - (SA1038)

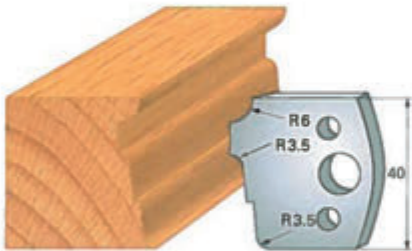

Art. SA0039 - (SA1039)

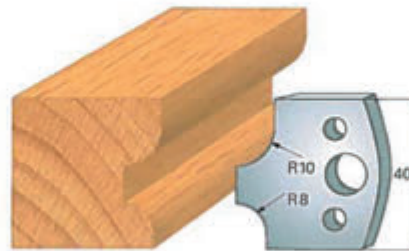

Art. SA0040 - (SA1040)

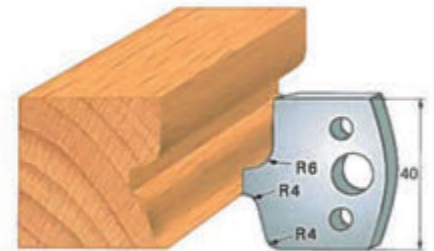

Art. SA0041 - (SA1041)

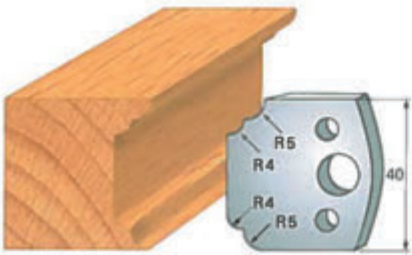

Art. SA0042 - (SA1042)

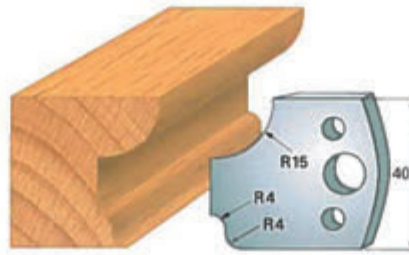

Art. SA0043 - (SA1043)

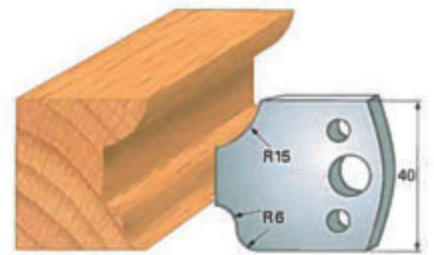

Art. SA0044 - (SA1044)

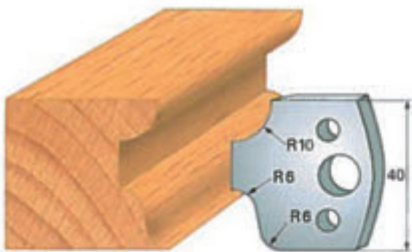

Art. SA0045 - (SA1045)

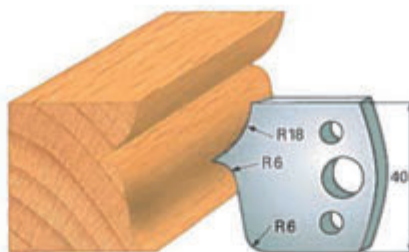

Art. SA0046 - (SA1046)

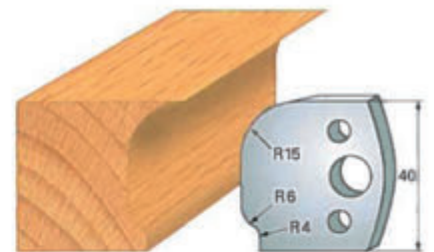

Art. SA0047 - (SA1047)

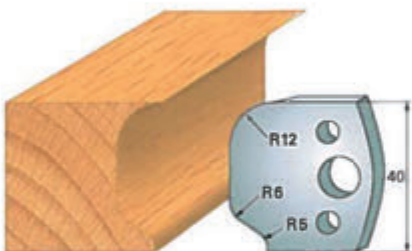

Art. SA0048 - (SA1048)

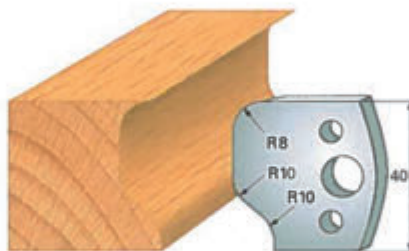

Art. SA0049 - (SA1049)

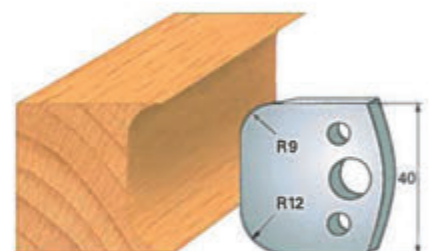

Art. SA0050 - (SA1050)



Art. SA0051 - (SA1051)

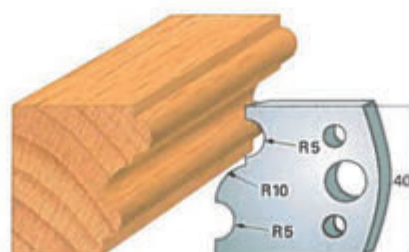

Art. SA0052 - (SA1052)

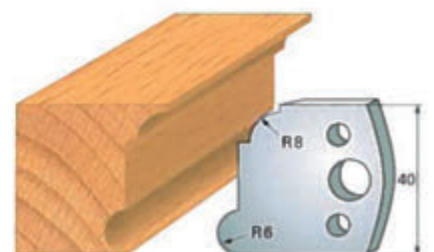

Art. SA0053 - (SA1053)

**STANDARD PROFILE KNIVES IN "SP" STEEL - height 40x4 mm
(RELATING LIMITERS)**

**Example:
Knife SA0..
Limiter (SA1..)**

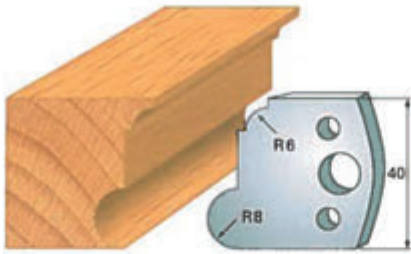

Art. SA0054 - (SA1054)

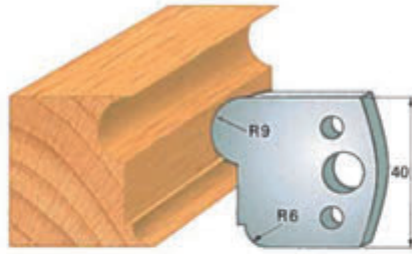

Art. SA0055 - (SA1055)

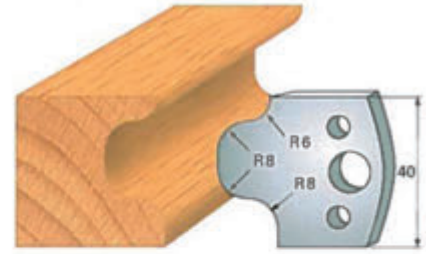

Art. SA0056 - (SA1056)

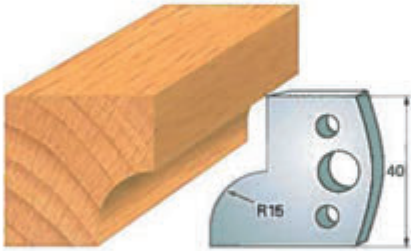

Art. SA0057 - (SA1057)

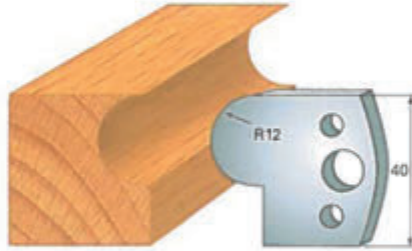

Art. SA0058 - (SA1058)

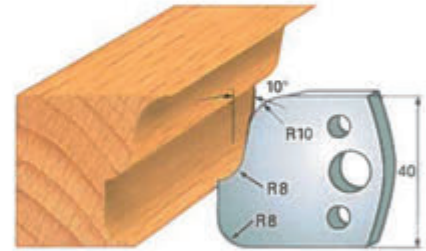

Art. SA0059 - (SA1059)

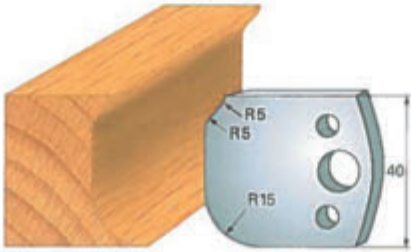

Art. SA0060 - (SA1060)

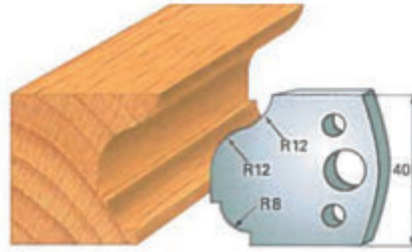

Art. SA0061 - (SA1061)

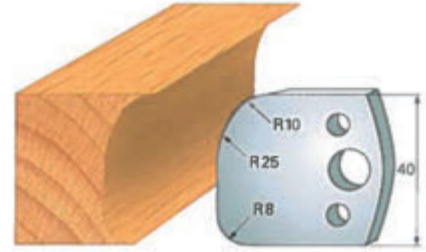

Art. SA0062 - (SA1062)

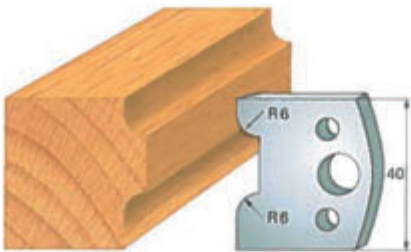

Art. SA0063 - (SA1063)

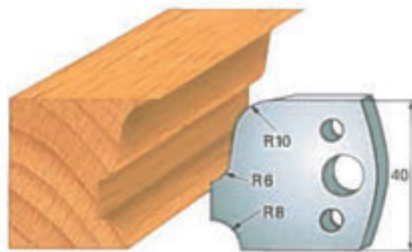

Art. SA0064 - (SA1064)

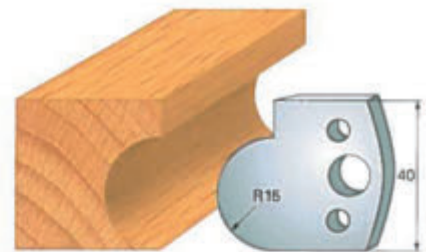

Art. SA0065 - (SA1065)

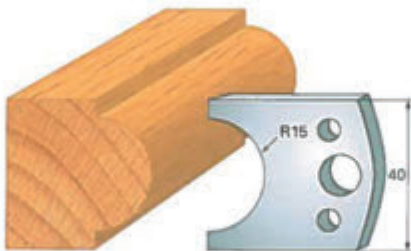

Art. SA0066 - (SA1066)

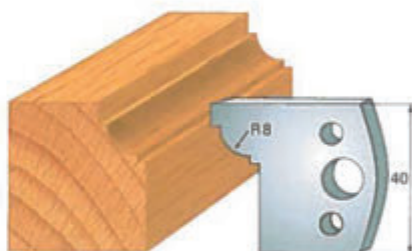

Art. SA0067 - (SA1067)

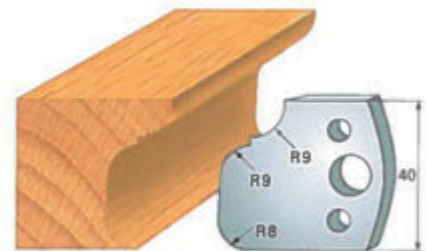

Art. SA0068 - (SA1068)

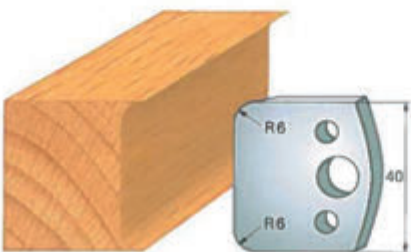

Art. SA0069 - (SA1069)

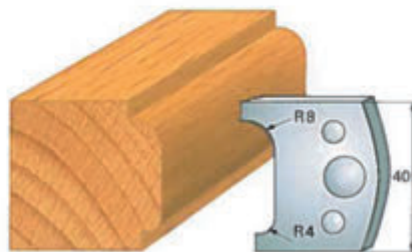

Art. SA0070 - (SA1070)

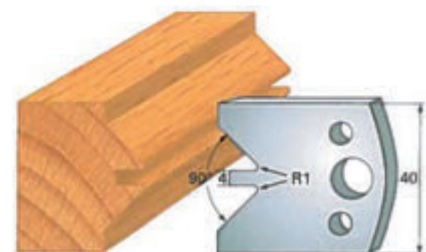

Art. SA0071 - (SA1071)

**STANDARD PROFILE KNIVES IN "SP" STEEL - height 40x4 mm
(RELATING LIMITERS)**

**Example:
Knife SA0..
Limiter (SA1..)**

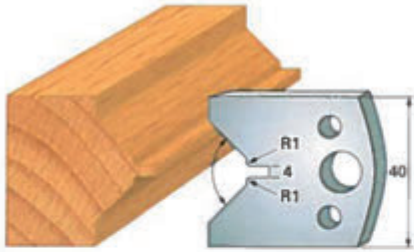

Art. SA0072 - (SA1072)

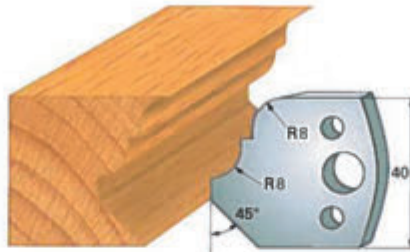

Art. SA0073 - (SA1073)

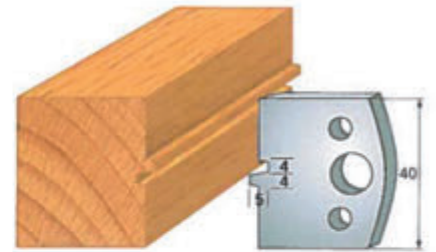

Art. SA0074 - (SA1074)

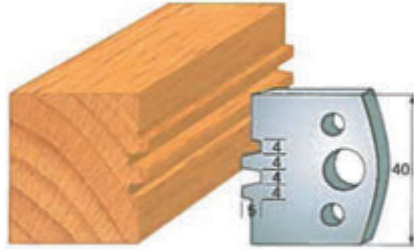

Art. SA0075 - (SA1075)

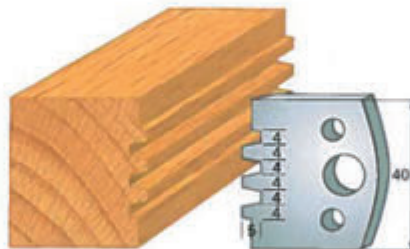

Art. SA0076 - (SA1076)

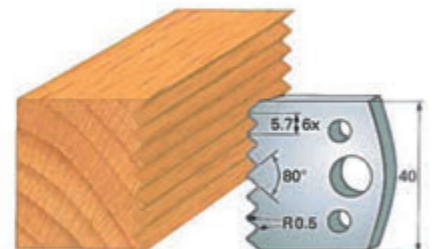

Art. SA0077 - (SA1077)

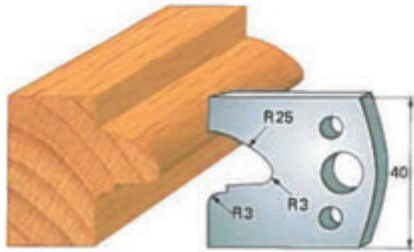

Art. SA0078 - (SA1078)

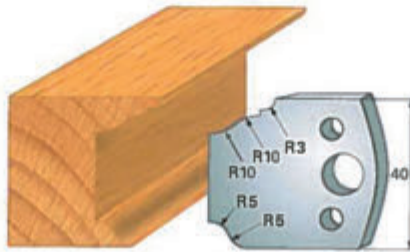

Art. SA0079 - (SA1079)

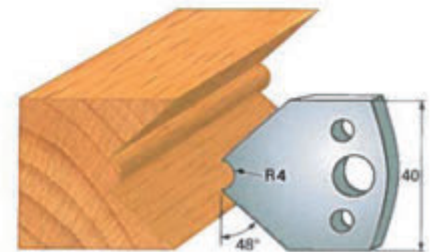

Art. SA0080 - (SA1080)

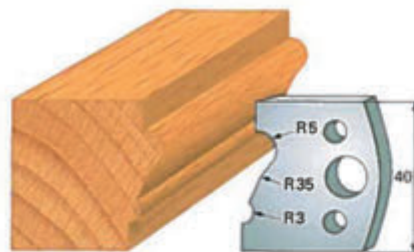

Art. SA0081 - (SA1081)

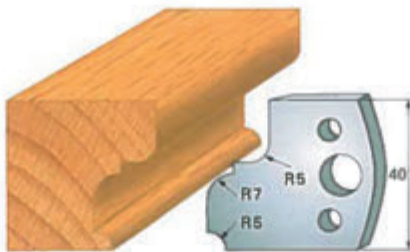

Art. SA0082 - (SA1082)

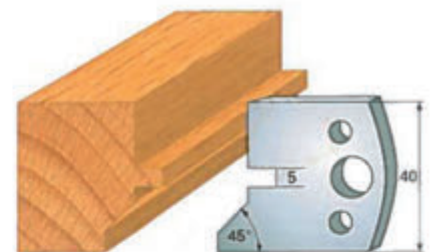

Art. SA0083 - (SA1083)

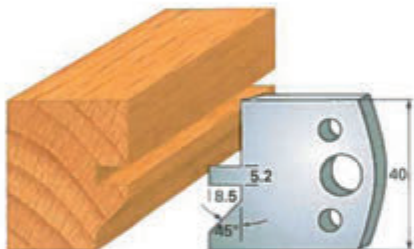

Art. SA0084 - (SA1084)

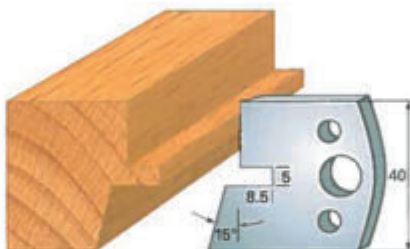

Art. SA0085 - (SA1085)

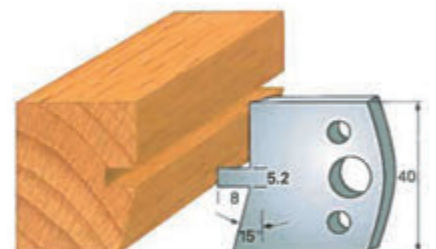

Art. SA0086 - (SA1086)

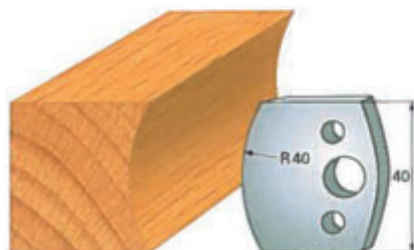

Art. SA0087 - (SA1087)

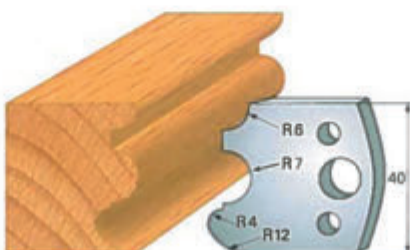

Art. SA0088 - (SA1088)

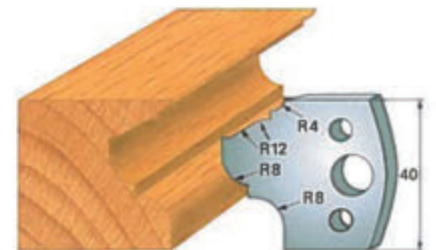

Art. SA0089 - (SA1089)

**STANDARD PROFILE KNIVES IN "SP" STEEL - height 40x4 mm
(RELATING LIMITERS)**

**Example:
Knife SA0..
Limiter (SA1..)**

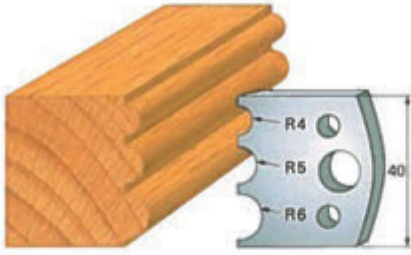

Art. SA0090 - (SA1090)

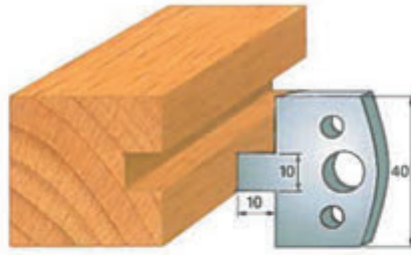

Art. SA0091 - (SA1091)

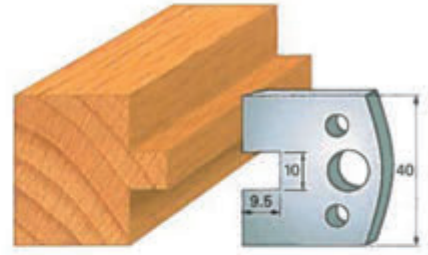

Art. SA0092 - (SA1092)

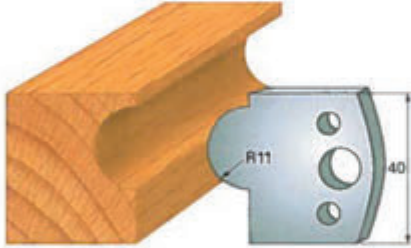

Art. SA0093 - (SA1093)

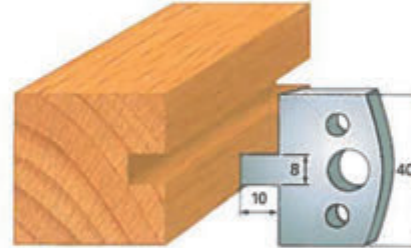

Art. SA0094 - (SA1094)

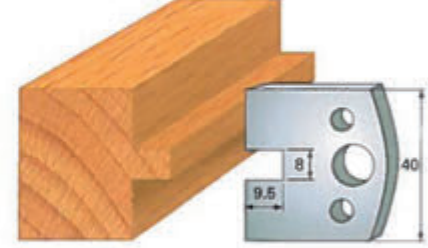

Art. SA0095 - (SA1095)

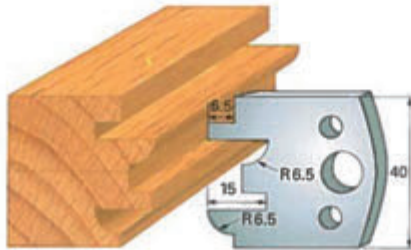

Art. SA0096 - (SA1096)

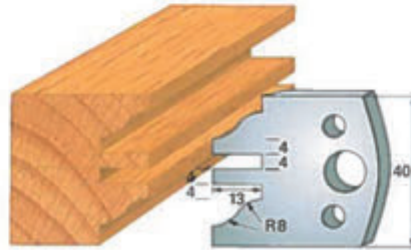

Art. SA0097 - (SA1097)

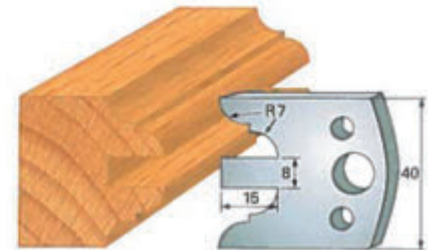

Art. SA0098 - (SA1098)

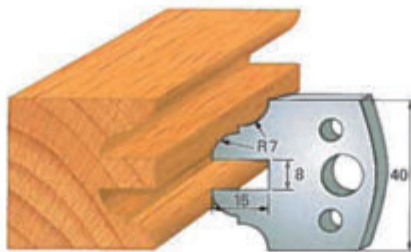

Art. SA0099 - (SA1099)

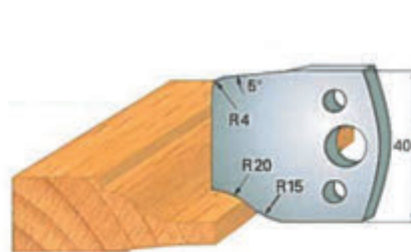

Art. SA0100 - (SA1100)

**STANDARD PROFILE KNIVES IN "SP" STEEL - height 50x4 mm
(RELATING LIMITERS)**

**Example:
Knife SA2..
Limiter (SA3..)**

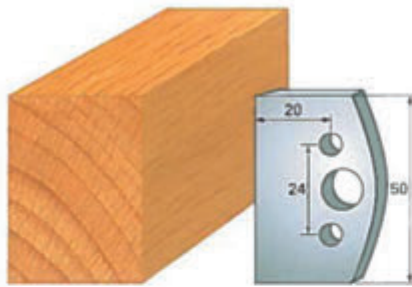

Art. SA2000 - (SA3000)

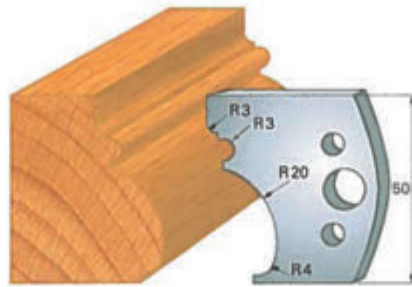

Art. SA2001 - (SA3001)



Art. SA2002 - (SA3002)

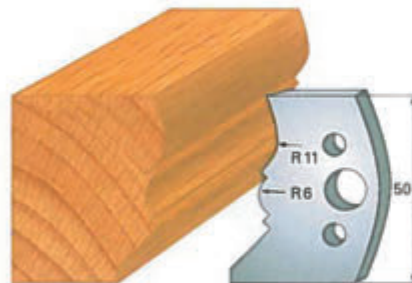

Art. SA2004 - (SA3004)

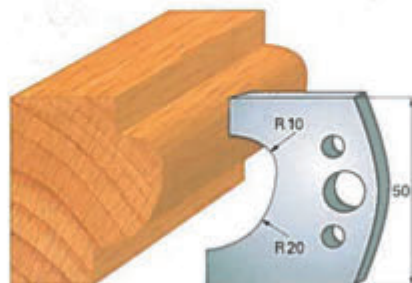

Art. SA2005 - (SA3005)

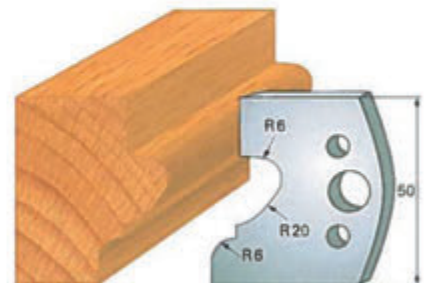

Art. SA2006 - (SA3006)

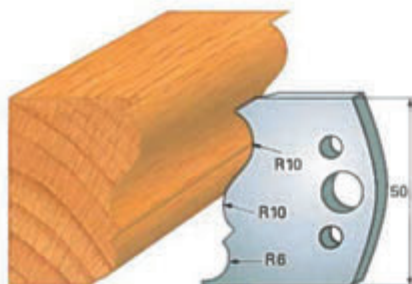

Art. SA2007 - (SA3007)



Art. SA2008 - (SA3008)

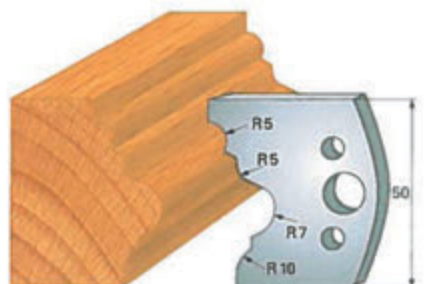

Art. SA2009 - (SA3009)

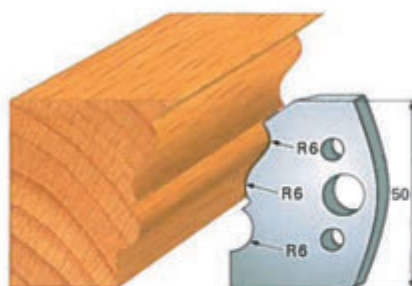

Art. SA2010 - (SA3010)

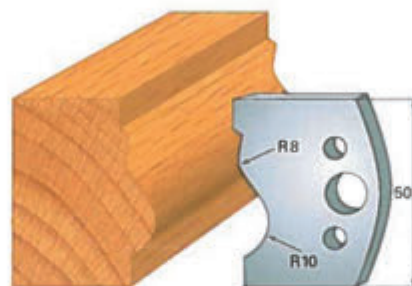

Art. SA2011 - (SA3011)

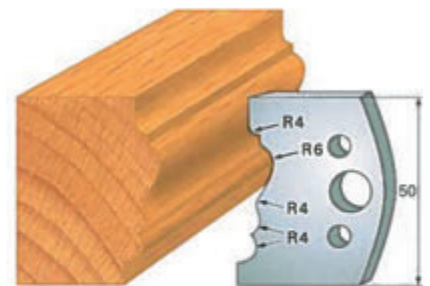

Art. SA2012 - (SA3012)

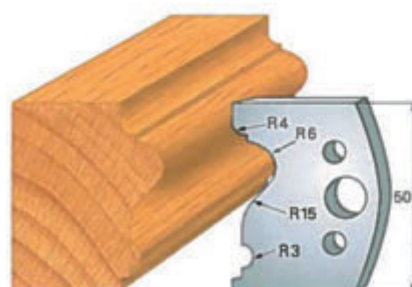

Art. SA2013 - (SA3013)

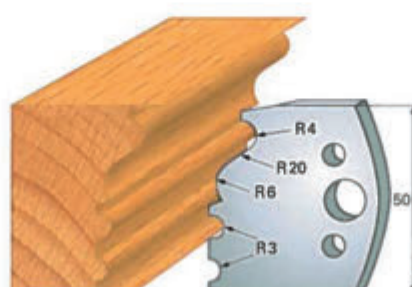

Art. SA2014 - (SA3014)

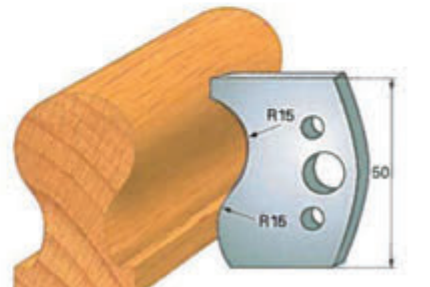

Art. SA2015 - (SA3015)

**STANDARD PROFILE KNIVES IN "SP" STEEL - height 50x4 mm
(RELATING LIMITERS)**

**Example:
Knife SA2..
Limiter (SA3..)**

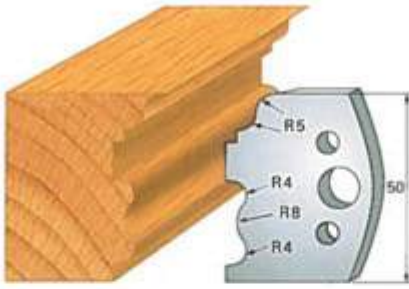

Art. SA2016 - (SA3016)

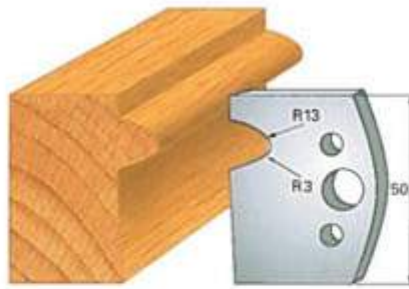

Art. SA2017 - (SA3017)

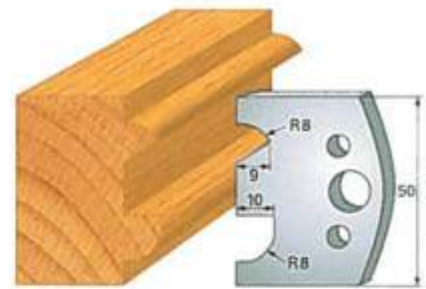

Art. SA2018 - (SA3018)

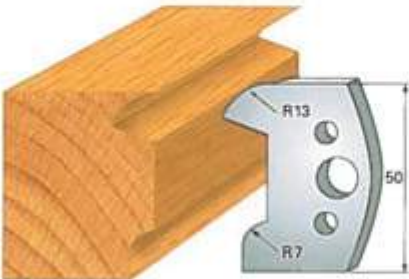

Art. SA2019 - (SA3019)

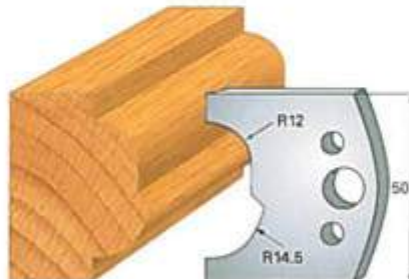

Art. SA2020 - (SA3020)

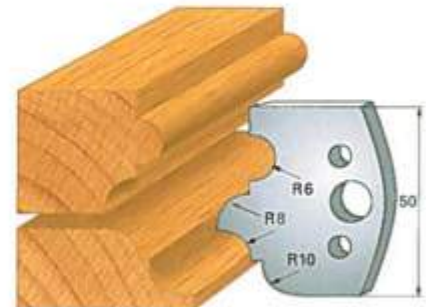

Art. SA2021 - (SA3021)



Art. SA2022 - (SA3022)

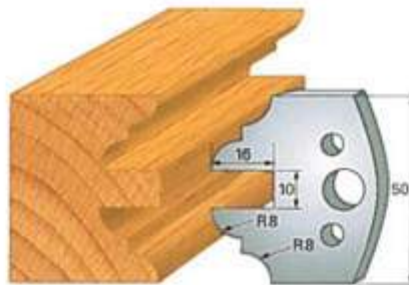

Art. SA2023 - (SA3023)



Art. SA2024 - (SA3024)

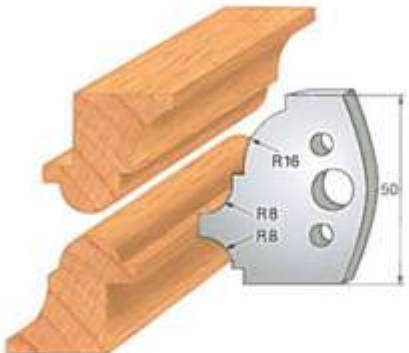

Art. SA2025 - (SA3025)

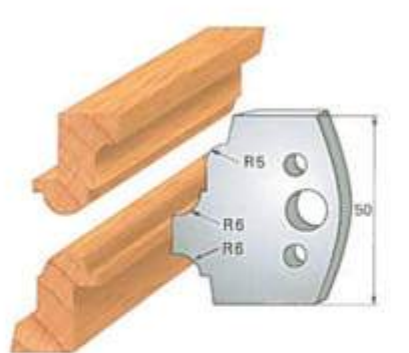

Art. SA2026 - (SA3026)



Art. SA2027 - (SA3027)



Art. SA2028 - (SA3028)



Art. SA2029 - (SA3029)

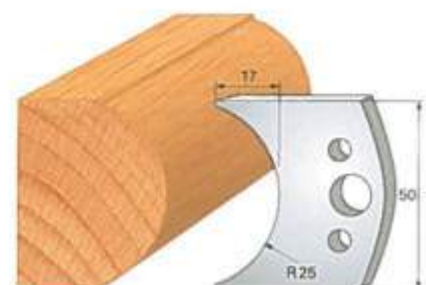

Art. SA2030 - (SA3030)

**STANDARD PROFILE KNIVES IN "SP" STEEL - height 50x4 mm
(RELATING LIMITERS)**

**Example:
Knife SA2..
Limiter (SA3..)**



Art. SA2031 - (SA3031)



Art. SA2032 - (SA3032)



Art. SA2033 - (SA3033)



Art. SA2034 - (SA3034)

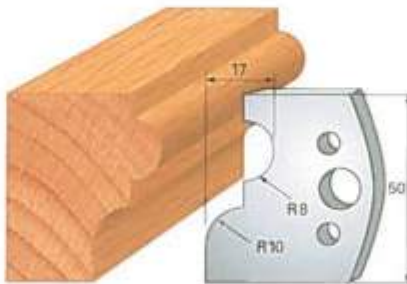

Art. SA2035 - (SA3035)

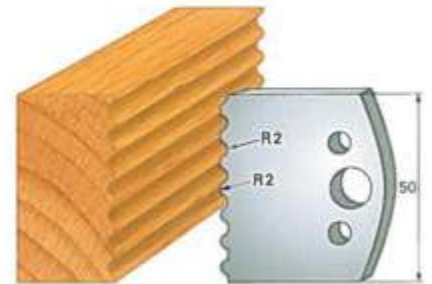

Art. SA2036 - (SA3036)



Art. SA2037 - (SA3037)



Art. SA2038 - (SA3038)



Art. SA2039 - (SA3039)



Art. SA2040 - (SA3040)

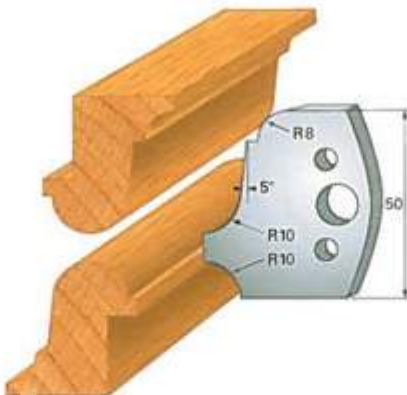

Art. SA2041 - (SA3041)

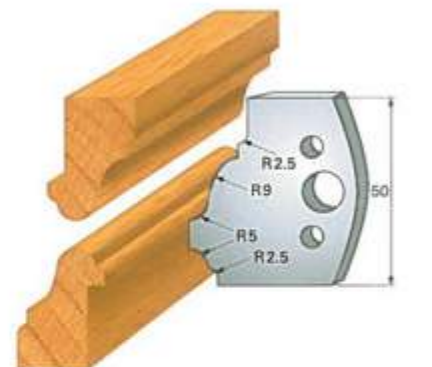

Art. SA2042 - (SA3042)



Art. SA2043 - (SA3043)



Art. SA2044 - (SA3044)



Art. SA2045 - (SA3045)

**STANDARD PROFILE KNIVES IN "SP" STEEL - height 50x4 mm
(RELATING LIMITERS)**

**Example:
Knife SA2..
Limiter (SA3..)**

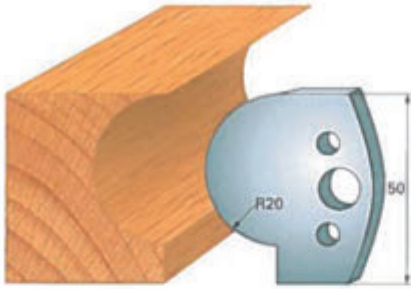

Art. SA2046 - (SA3046)



Art. SA2047 - (SA3047)

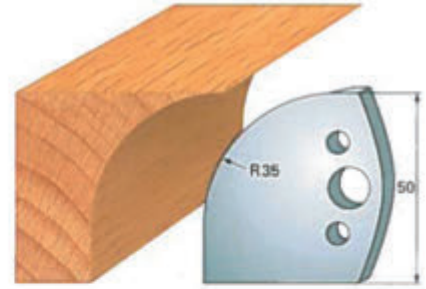

Art. SA2048 - (SA3048)

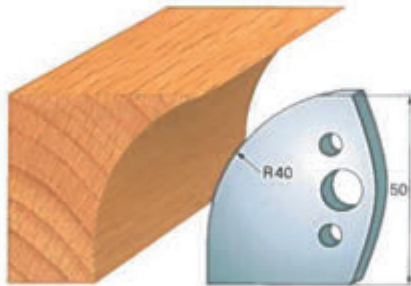

Art. SA2049 - (SA3049)

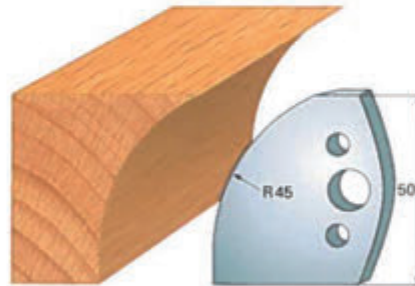

Art. SA2050 - (SA3050)

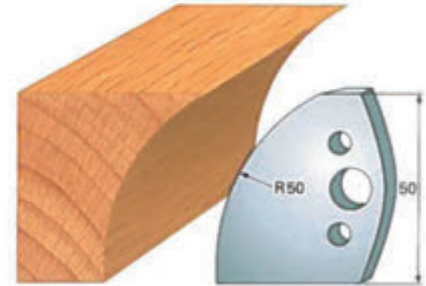

Art. SA2051 - (SA3051)

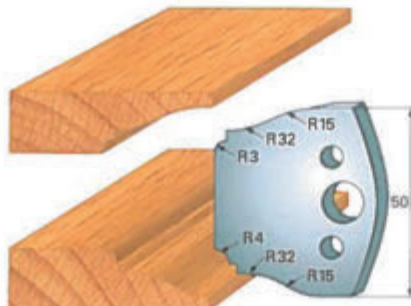

Art. SA2052 - (SA3052)

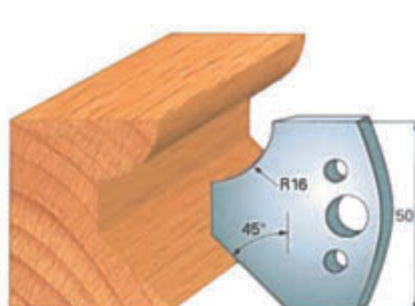

Art. SA2053 - (SA3053)

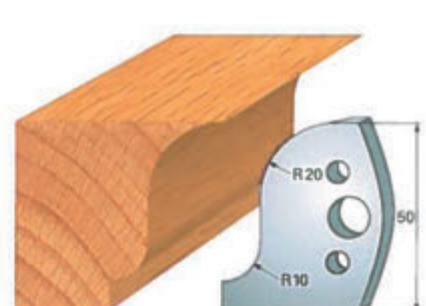

Art. SA2054 - (SA3054)

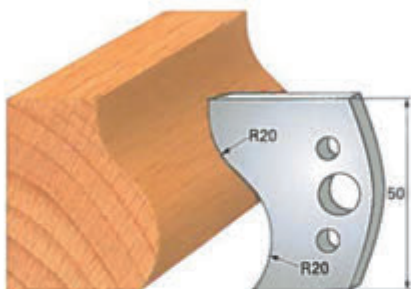

Art. SA2055 - (SA3055)



Art. SA2056 - (SA3056)



Art. SA2057 - (SA3057)



Art. SA2058 - (SA3058)

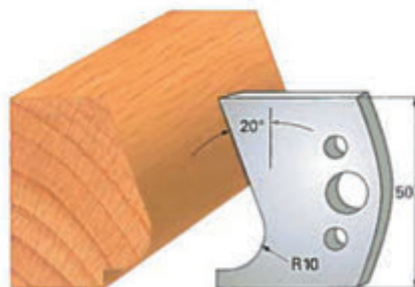

Art. SA2059 - (SA3059)

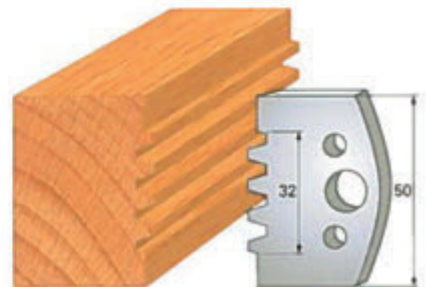

Art. SA2060 - (SA3060)

**STANDARD PROFILE KNIVES IN "SP" STEEL - height 50x4 mm
(RELATING LIMITERS)**

**Example:
Knife SA2..
Limiter (SA3..)**

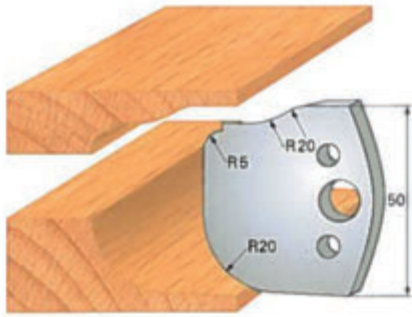

Art. SA2061 - (SA3061)

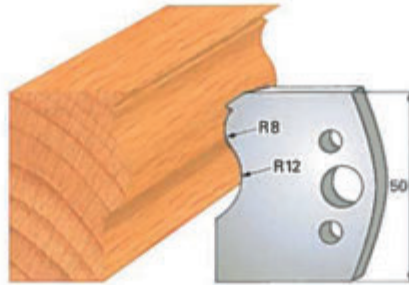

Art. SA2062 - (SA3062)

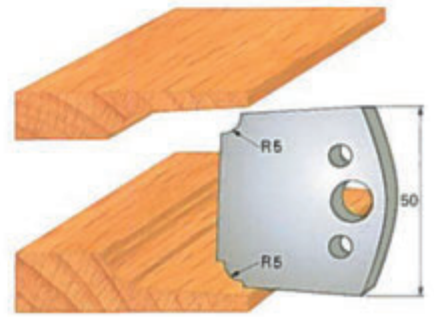

Art. SA2063 - (SA3063)

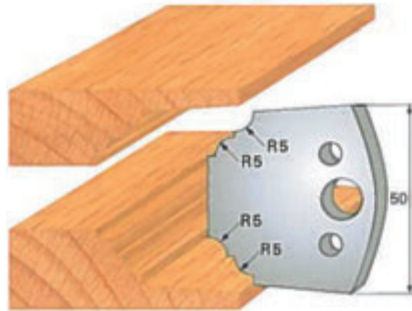

Art. SA2064 - (SA3064)

HW ADJUSTABLE CUTTERHEAD WITH REVERSIBLE KNIVES FOR GROOVES

ART. TA

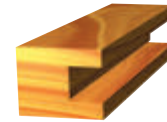
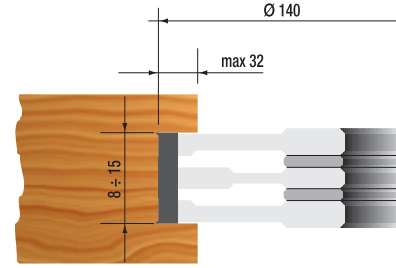
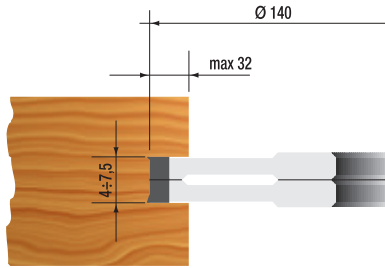

- For precision grooves 4 to 15 mm
- Adjustable by using spacer rings (included)
- Cutterhead in steel with reversible HW knives
- Manual feed (MAN)

Item		D	d	B	Z	V	E _{max}
TA140.07530	A+A	140	30	4 ÷ 7,5	4	4	32
TA140.07535	A+A	140	35	4 ÷ 7,5	4	4	32
TA140.07630	B	140	30	7,65	2	-	32
TA140.07635	B	140	35	7,65	2	-	32
TA140.15030	A+B+A	140	30	4 ÷ 15	4+2	4	32
TA140.15035	A+B+A	140	35	4 ÷ 15	4+2	4	32
TA180.07530	A+A	180	30	4 ÷ 7,5	8	4	32
TA180.07535	A+A	180	35	4 ÷ 7,5	8	4	32
TA180.07630	B	180	30	7,65	2	-	32
TA180.07635	B	180	35	7,65	2	-	32
TA180.15030	A+B+A	180	30	4 ÷ 15	8	4	32
TA180.15035	A+B+A	180	35	4 ÷ 15	8	4	32

Spare parts:	TA140.075		TA140.076	
	Dimensions	Item	Dimensions	Item
Knife	18x18x1,95	Z055.020.N	7,6x12x1,5	Z055.000.N
Knife screw	M4x3,2	Z051.700.R		
Threaded ring	12x1,7	Z060.701.R		
Spur	14x14x1,2	Z055.006.N		
Spur screw	M4x3,2	Z051.700.R		
Threaded ring	10x1,65	Z060.700.R		
Wedge	-	-	6,8	Z056.700.N
Wedge screw	-	-	M5x18	Z051.800.R

HW CUTTERHEADS WITH REVERSIBLE KNIVES FOR "LAMELLO"

ART. TAH

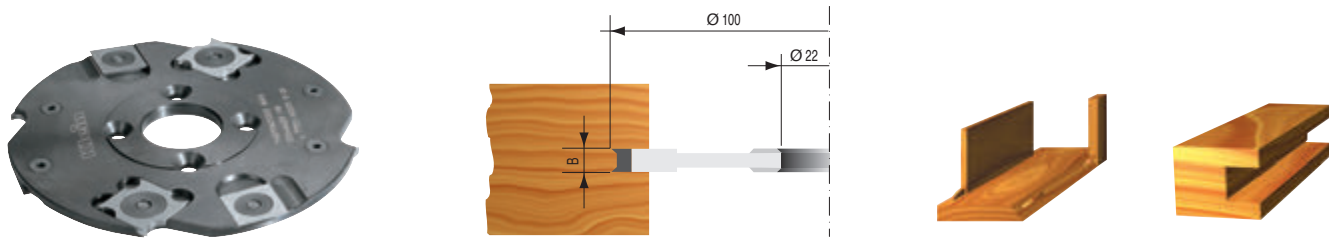

- For "Lamello" biscuit jointers on any kind of wood
- Cutterhead in steel with reversible HW knives and spurs
- Manual feed (MAN)

Item	D	d	B	Z	V
TAH100.20622	100	22	4	4	4

Spare parts:

	Dimension	Item
Knife	18x18x1,5	Z055.020.N
Knife screw	M4x3,2	Z051.700.R
Threaded ring	12x1,7	Z060.701.R
Spur	14x14x1,2	Z055.006.N
Spur screw	M4x3,2	Z051.700.R
Threaded ring	10x1,65	Z060.700.R

HW ADJUSTABLE CUTTERHEAD WITH REVERSIBLE KNIVES FOR GROOVES

ART. TB

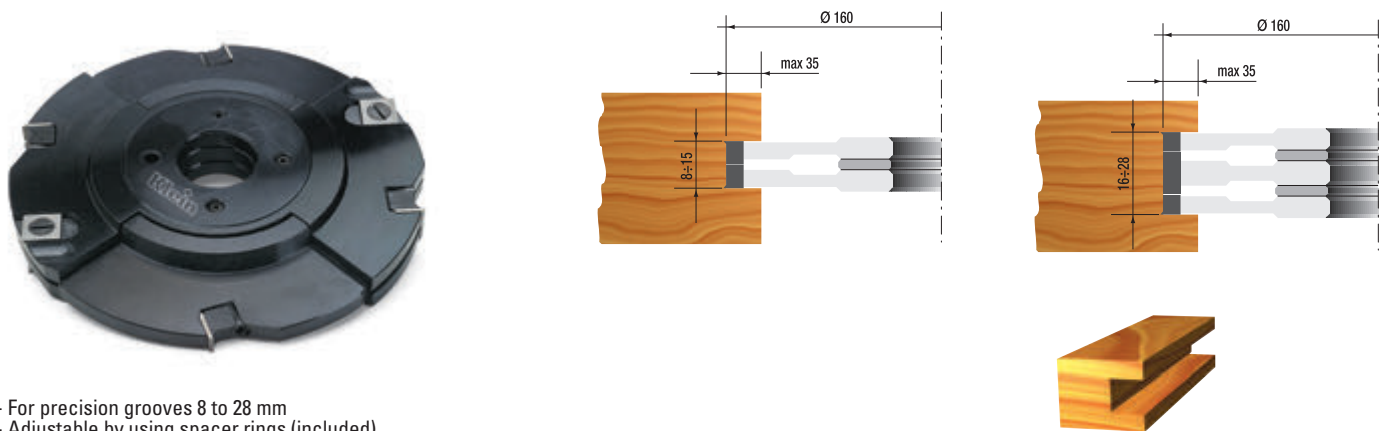

- For precision grooves 8 to 28 mm
- Adjustable by using spacer rings (included)
- Cutterhead in steel with reversible HW knives
- Manual feed (MAN)

Item		D	d	B	Z	V	E _{max}
TB160.15030	A+A	160	30	8÷15	4	4	35
TB160.15035	A+A	160	35	8÷15	4	4	35
TB160.15040	A+A	160	40	8÷15	4	4	35
TB160.15130	B	160	30	15	2	-	35
TB160.15135	B	160	35	15	2	-	35
TB160.15140	B	160	40	15	2	-	35
TB160.28030	A+B+A	160	30	8÷28	4+2	4	35
TB160.28035	A+B+A	160	35	8÷28	4+2	4	35
TB160.28040	A+B+A	160	40	8÷28	4+2	4	35

Spare parts:	TB160.150		TB160.151	
	Dimension	Item	Dimension	Item
Knife	7,65x12x1,5	Z055.000.N	15x12x1,5	Z055.002.N
Wedge	6,8	Z056.700.N	14	Z056.701.N
Wedge screw	M5x18	Z051.800.R	M7x21	Z051.801.R
Spur	14x14x2	Z055.007.N		
Spur screw	M5x7	Z051.701.R		

HW ADJUSTABLE GROOVING CUTTERHEAD FOR TENONS

ART. TC

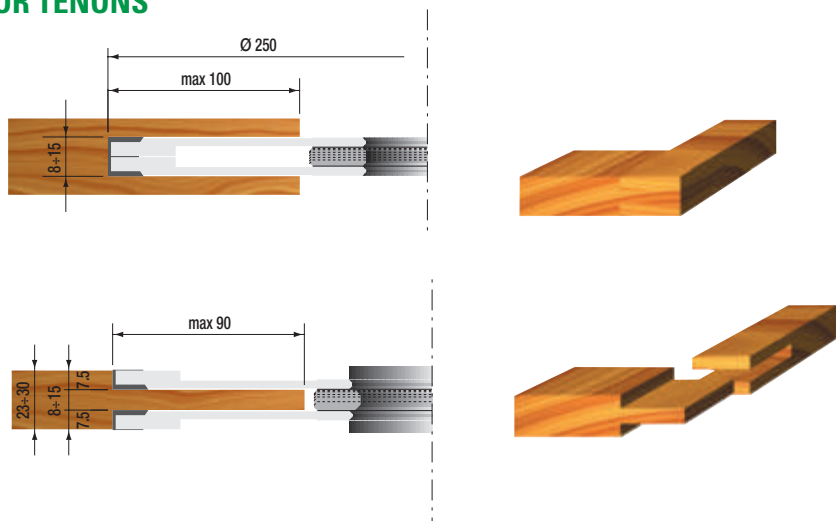

- For precision tenons 8 to 15 mm
- Adjustable by using spacer rings (included)
- Cutterhead in steel with reversible HW knives and spurs
- Manual feed (MAN)

Item	D	d	B	Z	V	E _{max}
TC250.15030	250	30	8÷15	4	4	100

Spare parts:

	Dimension	Item
Knife	7,6x12x1,5	Z055.000.N
Wedge	6,8	Z056.700.N
Wedge screw	M5x18	Z051.800.R
Spur	14x14x2	Z055.007.N
Spur screw	M5x7	Z051.701.R

HW CUTTERHEAD WITH REVERSIBLE STRAIGHT KNIVES AND SPURS

ART. TEL



- Cutterhead for precision rebating straight cut
- Light alloy with reversible HW knives and spurs
- Manual feed (MAN)

Item	D	d	B	Z	V
TEL100.50030	100	30	50	2	4
TEL100.50035	100	35	50	2	4
TEL125.50040	125	40	50	2	4
TEL125.50050	125	50	50	2	4

Spare parts:

	Dimension	Item
Knife	50x12x1,5	Z055.010.N
Wedge	46	Z056.702.N
Wedge screw	M8x16	Z051.810.R
Spur	14x14x2	Z055.007.N
Spur screw	M5x7	Z051.701.R

HW CUTTERHEAD WITH REVERSIBLE STRAIGHT KNIVES AND SPURS

ART. TF

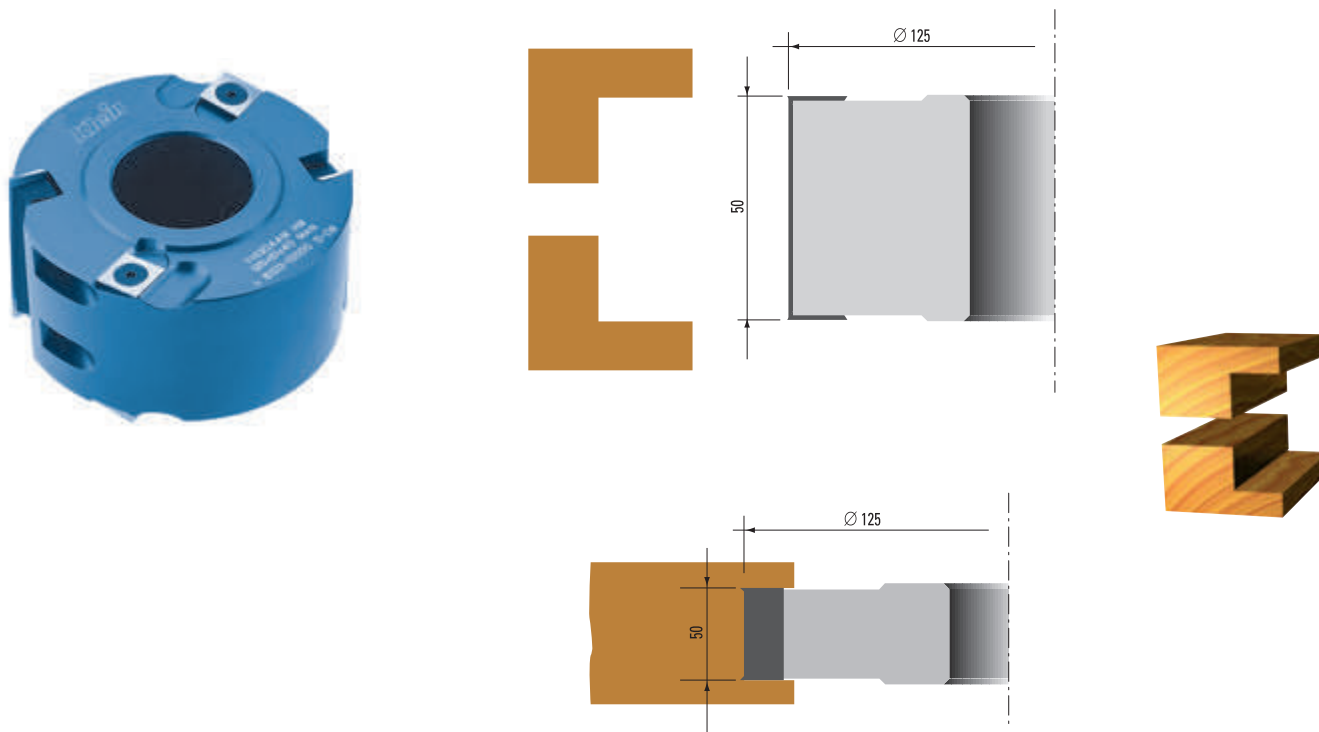

- Cutterhead for precision rebating straight cut, shear angle
- Steel body with reversible HW knives and spurs
- Manual feed (MAN)

Item	D	d	B	Z	V
TF125.30030	125	30	30	2	4
TF125.30035	125	35	30	2	4
TF125.30040	125	40	30	2	4
TF125.30050	125	50	30	2	4
TF125.50030	125	30	50	2	4
TF125.50035	125	35	50	2	4
TF125.50040	125	40	50	2	4
TF125.50050	125	50	50	2	4
TF125.50130	125	30	50	4	4
TF125.50135	125	35	50	4	4
TF125.50140	125	40	50	4	4
TF125.50150	125	50	50	4	4

	TF125.300		TF125.500	
	Dimension	Item	Dimension	Item
Knife	30x12x1,5	Z055.008.N	50x12x1,5	Z055.010.N
Wedge	26	Z056.703.N	46	Z056.702.N
Wedge screw	M7x21	Z051.801.R	M7x21	Z051.801.R
Spur	14x14x2	Z055.007.N	14x14x2	Z055.007.N
Spur screw	M5x7	Z051.701.R	M5x7	Z051.701.R

REBATING-GROOVING SET

ART. TX

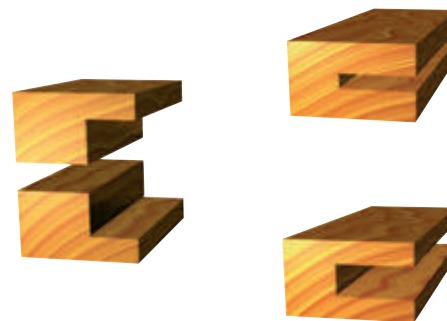
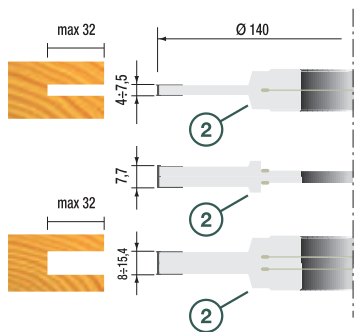
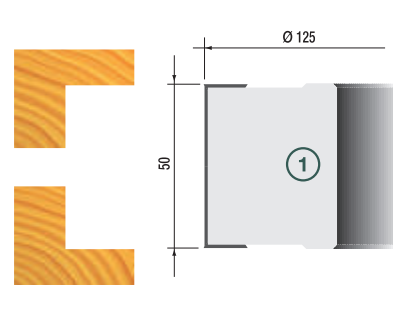
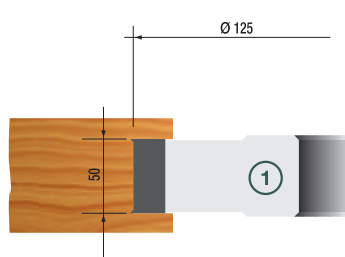

- Complete with: **TA140.15030**
TEL100.50030
- Manual feed (MAN)
- Available with bore 35

Item

TX0001 Rebating-grooving set in plastic case with bore 30

HW CUTTERHEAD FOR 45° BEVELS

ART. THL

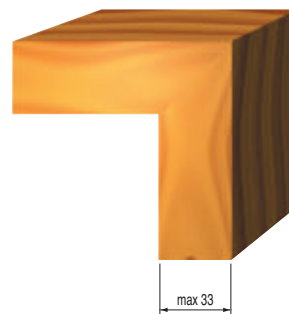
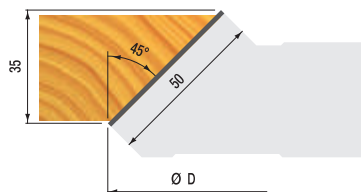

- Light alloy body for extremely accurate 45° bevels
- Reversible HW knives
- Manual feed (MAN)

Item	D	d	B	Z
THL150.36030	150	30	36	2
THL150.36035	150	35	36	2

Spare parts:

	Dimension	Item
Knife	50x12x1,5	Z055.010.N
Wedge	-	Z056.704.N
Wedge stop	-	Z056.800.N
Screw	M8x21	Z051.802.R

HW ADJUSTABLE BEVEL CUTTERHEAD

ART. TI

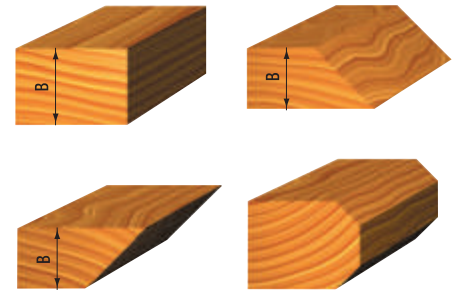
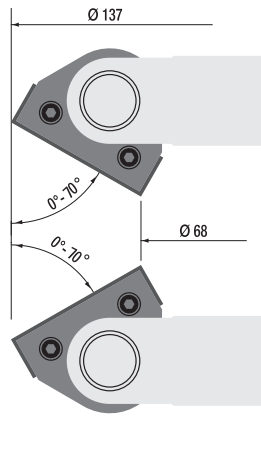

- Bevel cutterhead, adjustable by 1° on a scale
- Adjustment + 70° - 70°
- Steel tool body with HW reversible knives
- Manual feed (MAN)

Item	D	d	B	Z	α
T1160.50030	160	30	50	2	0+70°/0-70°
T1160.50035	160	35	50	2	0+70°/0-70°
T1160.50040	160	40	50	2	0+70°/0-70°
T1170.50050	170	50	50	2	0+70°/0-70°

Spare parts:		T1160.500	T1170.500
	Dimension	Item	
Knife	50x12x1,5	Z055.010.N	
Wedge	47	Z056.706.N	
Wedge screw	M6x12	Z051.804.R	

HW TOOLING SET FOR ROUNDING AND CHAMFERING

ART. TLL

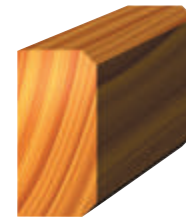
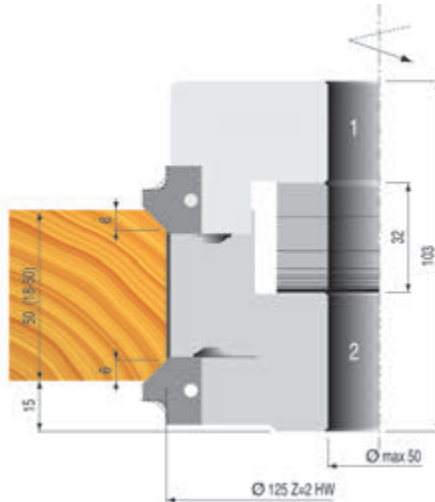
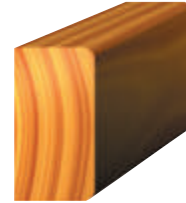
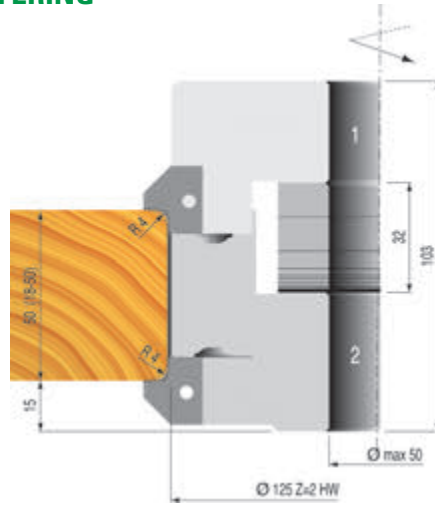

- Set of cutterhead for round profiles (R=2-3-4-5-6) on one side and 45° chamfer on the other
- Produced in light alloy complete with HW replaceable knives, spacing rings and two flanges for manual feeding
- Available also with bore 35/40/50

Item	D	d	B	Z	R	α
TLL139.50230	139	30	15÷50	2	2	45°
TLL139.50330	139	30	15÷50	2	3	45°
TLL139.50430	139	30	15÷50	2	4	45°
TLL139.50530	139	30	15÷50	2	5	45°
TLL139.50630	139	30	15÷50	2	6	45°

TLL139 diameter 139 mm. bore 35 mm. (code number ends with 35 instead of 30)

TLL139 diameter 139 mm. bore 40 mm. (code number ends with 40 instead of 30)

TLL139 diameter 139 mm. bore 50 mm. (code number ends with 50 instead of 30)

Spare parts:

	Dimension	Item
Knife	50x12x1,5	Z055.010.N
Wedge	-	Z056.707.N
Wedge screw	M8x20	Z051.805.R
Top profile knife	R=2/45°	Z055.800.R
Bottom profile knife	R=2/45°	Z055.800.L
Top profile knife	R=3/45°	Z055.801.R
Bottom profile knife	R=3/45°	Z055.801.L
Top profile knife	R=4/45°	Z055.802.R
Bottom profile knife	R=4/45°	Z055.802.L
Top profile knife	R=5/45°	Z055.803.R
Bottom profile knife	R=5/45°	Z055.803.L
Top profile knife	R=6/45°	Z055.804.R
Bottom profile knife	R=6/45°	Z055.804.L
Wedge	-	Z056.708.N
Wedge screw	M8x20	Z051.805.R

HW MULTIRADIUS SET

ART. TML

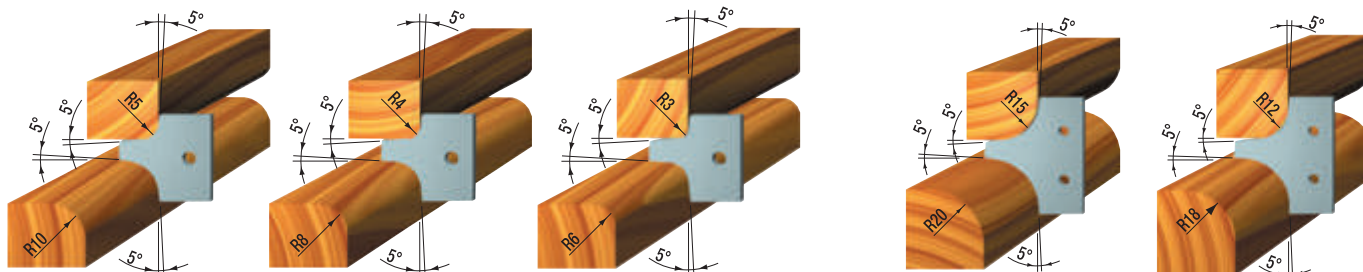
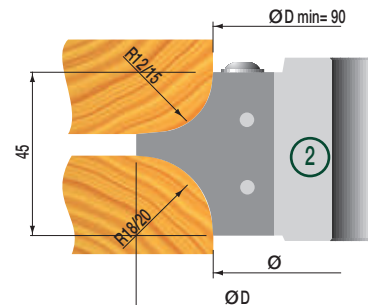
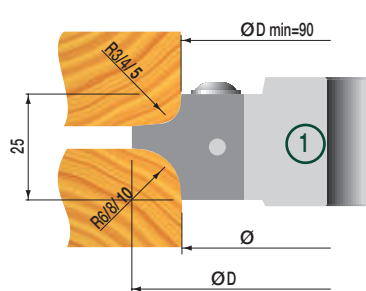

- Cutterhead with two radius knives mounted on the tools
- Produced in light alloy with HW knives
- Manual feed (MAN)
- Available also with bore 35/40/50

Item	D	d	B	Z	R
TML113.25330	113	30	25	2	3/6
TML113.25430	113	30	25	2	4/8
TML113.25530	113	30	25	2	5/10

TML113 diameter 113 mm. bore 35 mm. (code number ends with 35 instead of 30)

TML132.45230	132	30	45	2	12/18
TML132.45530	132	30	45	2	15/20

TML132 diameter 132 mm. bore 35 mm. (code number ends with 35 instead of 30)

Spare parts:		TML113.25	TML132.45
	Dimension	Item	Dimension
Profile knife	R= 3/6	Z055.805.R	R= 12/18
Profile knife	R= 4/8	Z055.806.R	R= 15/20
Profile knife	R= 5/10	Z055.807.R	-
Wedge	-	Z056.709.N	-
Wedge screw	M8x20	Z051.805.R	M8x20



Art. **TX0002** complete with: **TML113.25330** +
2 pcs. Z055.806.R +
2 pcs. Z055.807.R

Art. **TX0003** complete with: **TML132.45230** +
2 pcs. Z055.809.R

Available with bore 35

Item	Description
TX0002	Set in plastic box complete with cutterhead + 2 profile knives each R= 3/6 + R= 4/8 + R= 5/10 (bore 35 on request)
TX0003	Set in plastic box complete with cutterhead + 2 profile knives each R= 12/18 + R= 15/20 (bore 35 on request)

HW TOOLING SET FOR CONCAVE AND CONVEX QUARTER ROUNDS

ART. TNL

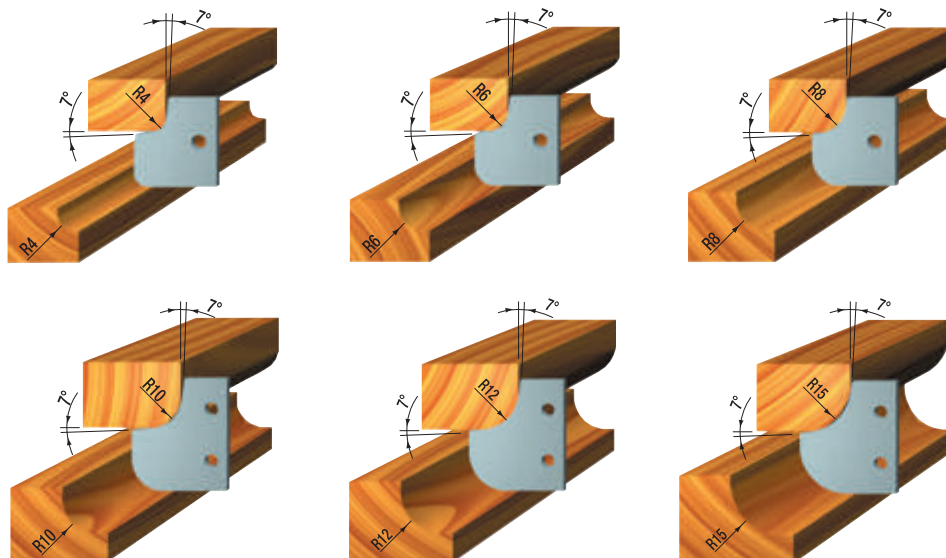
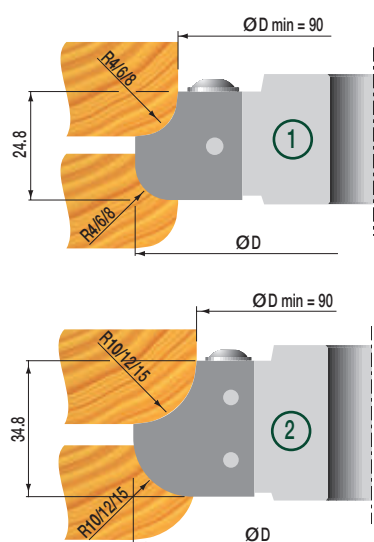

- Cutterhead with two radius knives mounted on the tools
- Produced in light alloy with HW knives
- Manual feed (MAN)
- Available also with bore 35/40/50

Item	D	d	B	Z	R
TNL110.25430	109	30	24,8	2	4-4
TNL110.25630	109	30	24,8	2	6-6
TNL110.25830	109	30	24,8	2	8-8
TNL122.35030	122	30	34,8	2	10-10
TNL122.35230	122	30	34,8	2	12-12
TNL122.35530	122	30	34,8	2	15-15

TNL122 diameter 122 mm. bore 35 mm. - R 10=15 (code number ends with 35 instead of 30)

Spare parts:	TNL110.25		TNL122.35	
	Dimension	Item	Dimension	Item
Profile knife	R= 4/4	Z055.810.R	R= 10/10	Z055.813.R
Profile knife	R= 6/6	Z055.811.R	R= 12/12	Z055.814.R
Profile knife	R= 8/8	Z055.812.R	R= 15/15	Z055.815.R
Wedge	-	Z056.710.N	-	Z056.711.N
Wedge screw	M8x20	Z051.805.R	M8x20	Z051.805.R



Art. **TX0004** complete with: **TNL110.25430** +
2 pcs. Z055.811.R +
2 pcs. Z055.812.R

Art. **TX0005** complete with: **TNL122.35030** +
2 pcs. Z055.814.R +
2 pcs. Z055.815.R

Available with bore 35

Item	Description
TX0004	Set in plastic box complete with cutterhead + 2 profile knives each R= 4/4 + R= 6/6 + R= 8/8 (bore 35 on request)
TX0005	Set in plastic box complete with cutterhead + 2 profile knives each R= 10/10 + R= 12/12 + R= 15/15 (bore 35 on request)

MULTIPROFILE SET

ART. TX

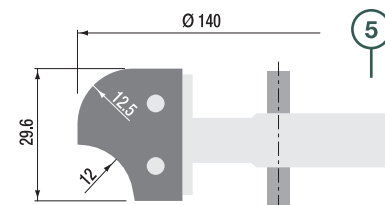
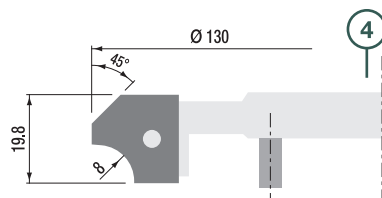
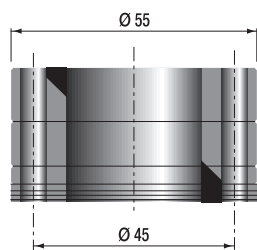
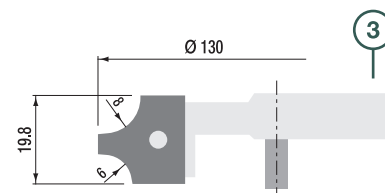
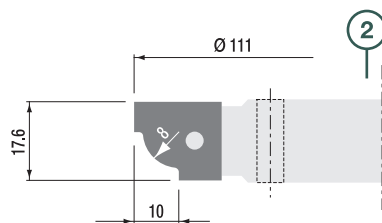
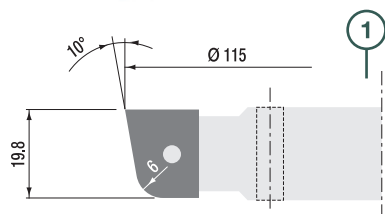

- Set complete with 5 heads in light alloy, Z=2 with HW knives and spacer rings
- For various profiles
- Manual feed (MAN)
- Available only with bore 30

Item	
TX0008 selling out	Multiprofile set in plastic box

Spare parts:

	Dimension	Item
Profile knife for head "1"	R=6	Z055.822.R
Profile knife for head "3"	R=6/8	Z055.824.R
Profile knife for head "4"	R=8/45°	Z055.825.R
Wedge	-	Z056.713.N
Profile knife for head "2"	R=8	Z055.823.R
Wedge	-	Z056.714.N
Profile knife for head "5"	R=12	Z055.826.R
Wedge	-	Z056.715.N
Wedge screw	M8x20	Z051.805.R

MULTIPROFILE SET

ART. TX

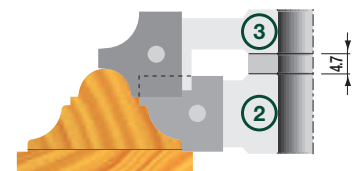
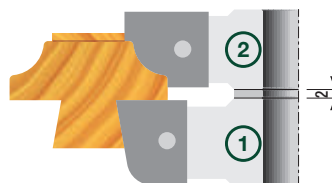
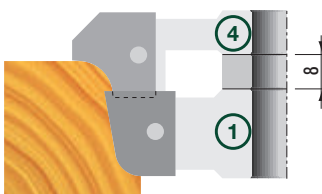
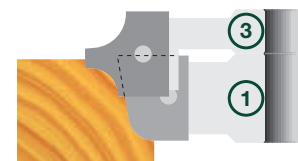
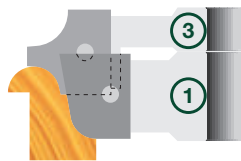
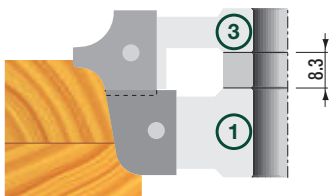
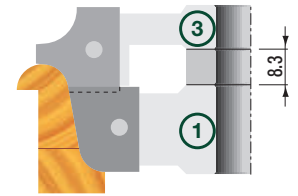
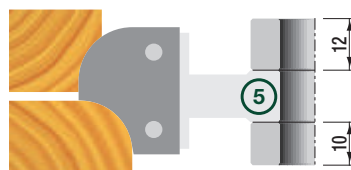
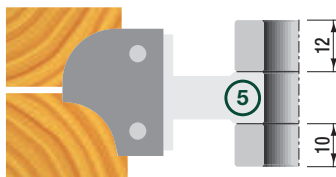

MULTIPROFILE SET

ART. TX

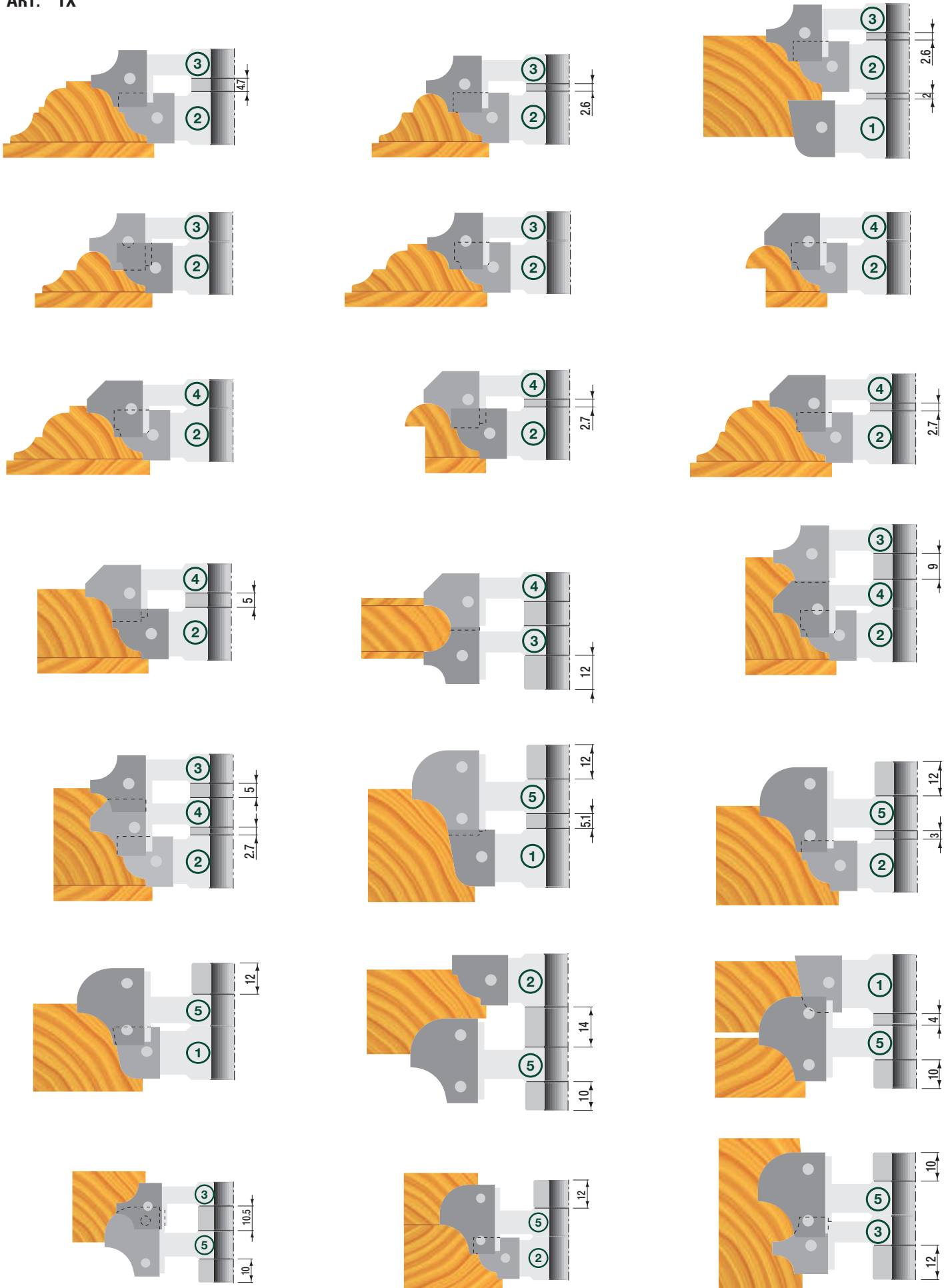

MULTIPROFILE SET

ART. TX

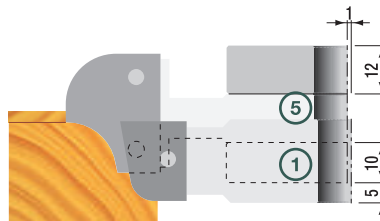
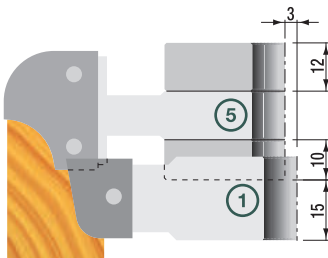
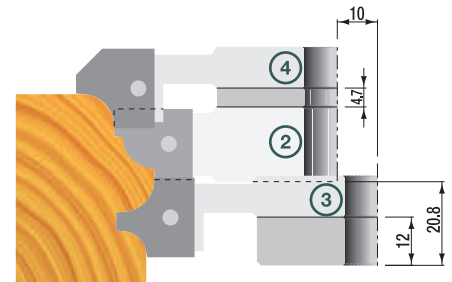
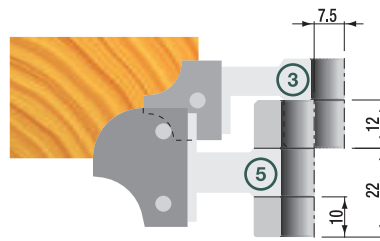
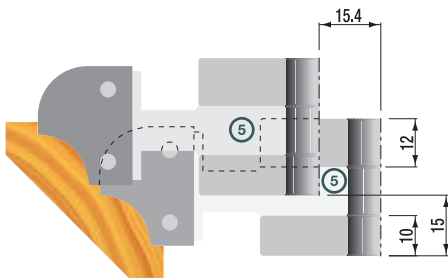
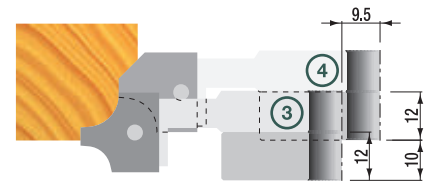
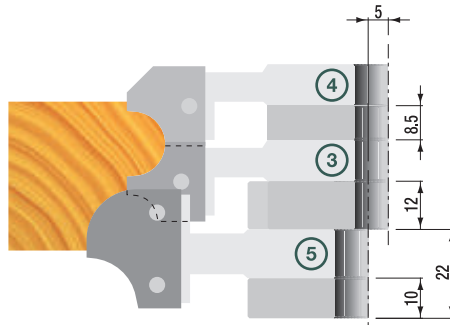
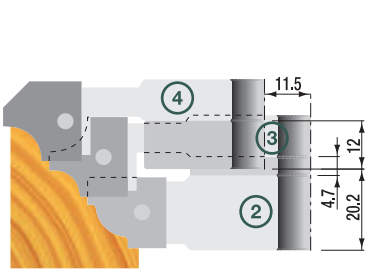
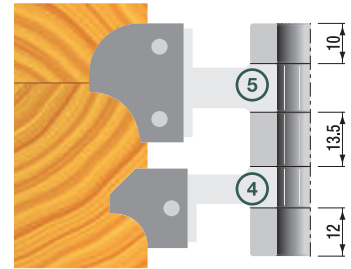
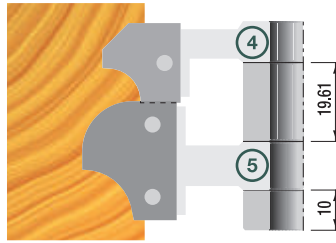
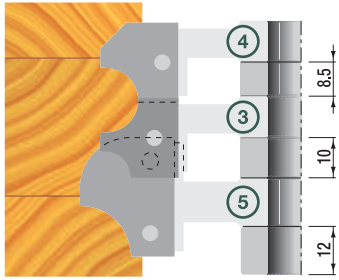

HW MITRE JOINT CUTTERHEAD 45°

ART. TSL

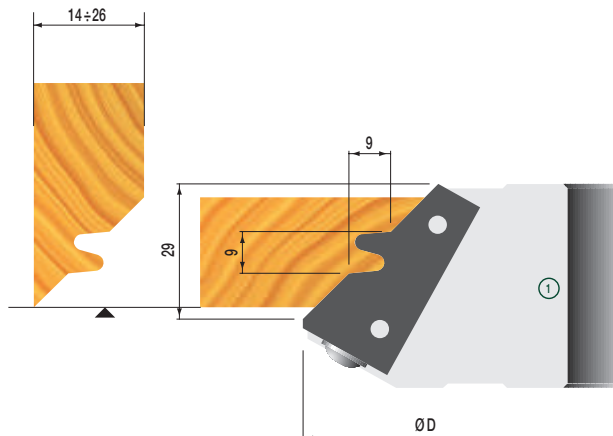

- Produced in light alloy with HW knives
- Manual feed (MAN)
- Available also with bore 35/40/50

item	D	d	B	Z
TSL140.32030	140	30	32	2
TSL140.32035	140	35	32	2
TSL140.32040	140	40	32	2

Spare parts:

	Dimension	Item
Knife	45	Z055.830.R
Wedge	-	Z056.719.N
Wedge stop	-	Z056.800.R
Wedge screw	M8X20	Z051.805.R

HW PROFILE CUTTER

ART. TS

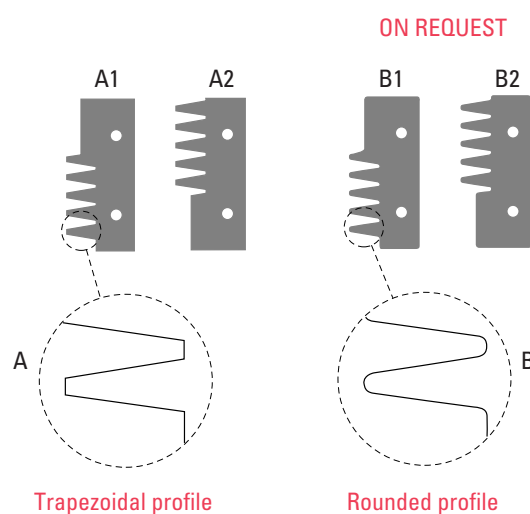
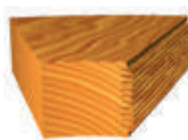
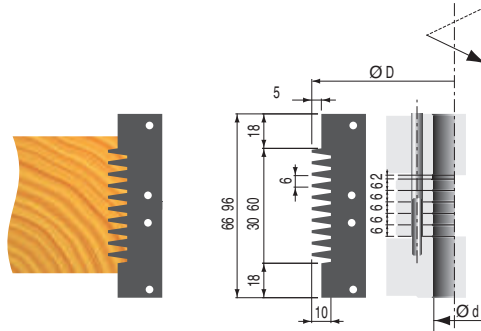

- Steel body with HW knives
- Adjustable by means of spacers
- Suitable for arch windows
- Manual feed (MAN)

Item	D	d	B	Z	Affilatura
TS140.96030	140	30	66÷96	2+2	A
TS140.96035	140	35	66÷96	2+2	A
TS140.96040	140	40	66÷96	2+2	A

Spare parts:

	Dimension	Item
Knife "A1"	50x22,5x2	Z055.861.N
Knife "A2"	50x22,5x2	Z055.862.N
Knife "B1"	50x22,5x2	Z055.863.N
Knife "B2"	50x22,5x2	Z055.864.N
Wedge	L= 46	Z056.726.N
Screw	M8X20	Z051.805.R

HW PANEL RAISING SET WITH SIX PROFILES

ART. TTL

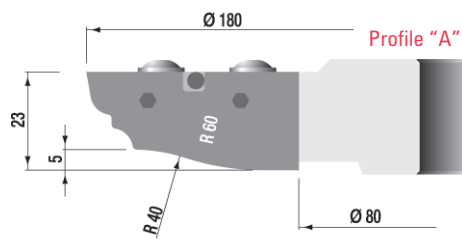
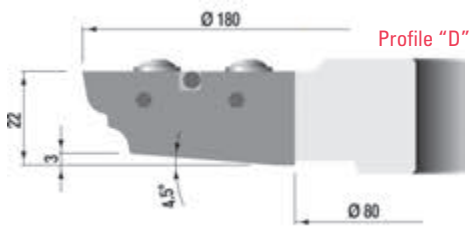

- Produced in light alloy with HW knives
- Six knives for working 12 different wood profiles (profiles "A" - "B" - "C" - "D" - "E" - "F")
- Manual feed (MAN)
- Available only with bore 30

Item	D	d	B	Profile	Z
TTL180.22130	180	30	22	D	2
TTL180.22230	180	30	22	E	2
TTL180.22330	180	30	22	F	2
TTL180.23130	180	30	23	A	2
TTL180.23230	180	30	23	B	2
TTL180.23330	180	30	23	C	2

Spare parts:

	Dimension	Item
Profile knife	Profile "A"	Z055.831.R
Profile knife	Profile "B"	Z055.832.R
Profile knife	Profile "C"	Z055.833.R
Profile knife	Profile "D"	Z055.834.R
Profile knife	Profile "E"	Z055.835.R
Profile knife	Profile "F"	Z055.836.R
Screw	M5x10	Z051.702.R

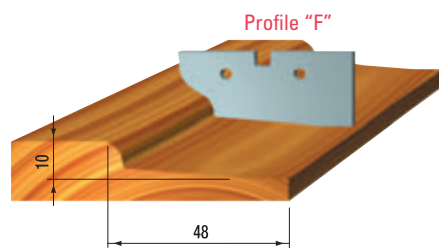
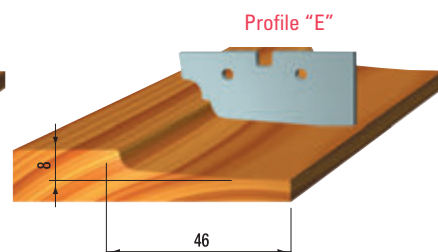
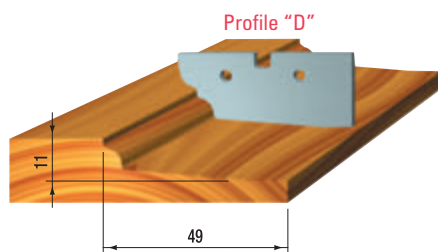
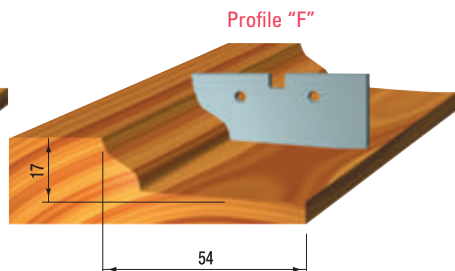
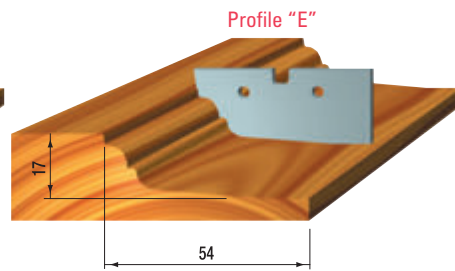
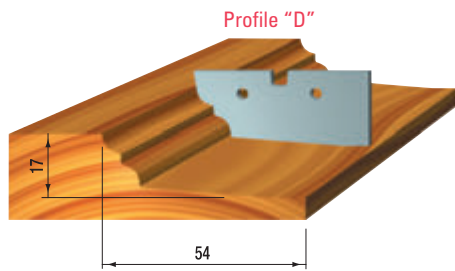
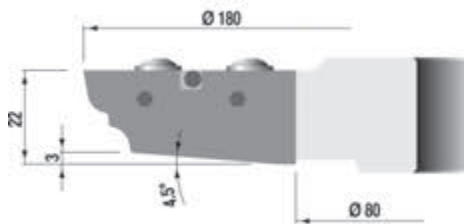

HW PANEL RAISING SET

ART. TTL

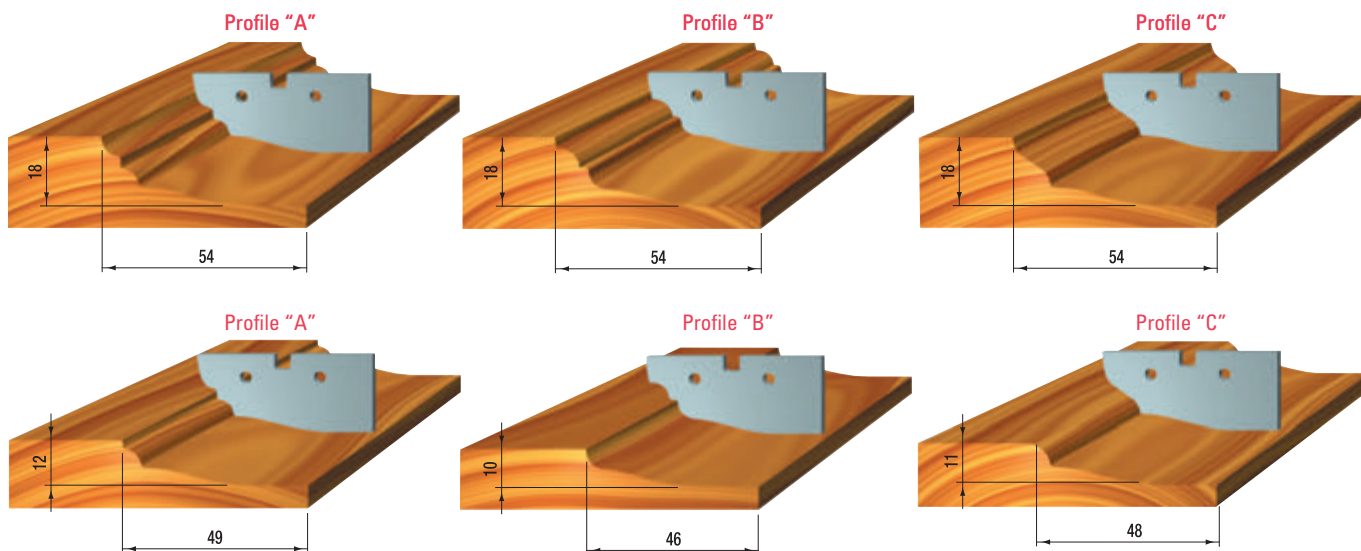
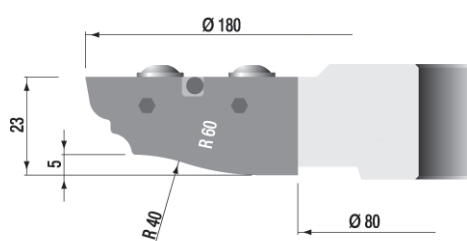

Art. **TX0010** complete with: **TTL180.22130** +
2 pz. Z055.835.R +
2 pz. Z055.836.R

Art. **TX0011** complete with: **TTL180.23130** +
2 pz. Z055.832.R +
2 pz. Z055.833.R

Available only with fore 30

Item	Description
TX0010	Set in plastic box with cutterhead + 2 profile knives each - Profile D + E + F
TX0011	Set in plastic box with cutterhead + 2 profile knives each - Profile A + B + C

HW PROFILE-COUNTERPROFILE PANEL RAISING CUTTERHEAD

ART. TUL

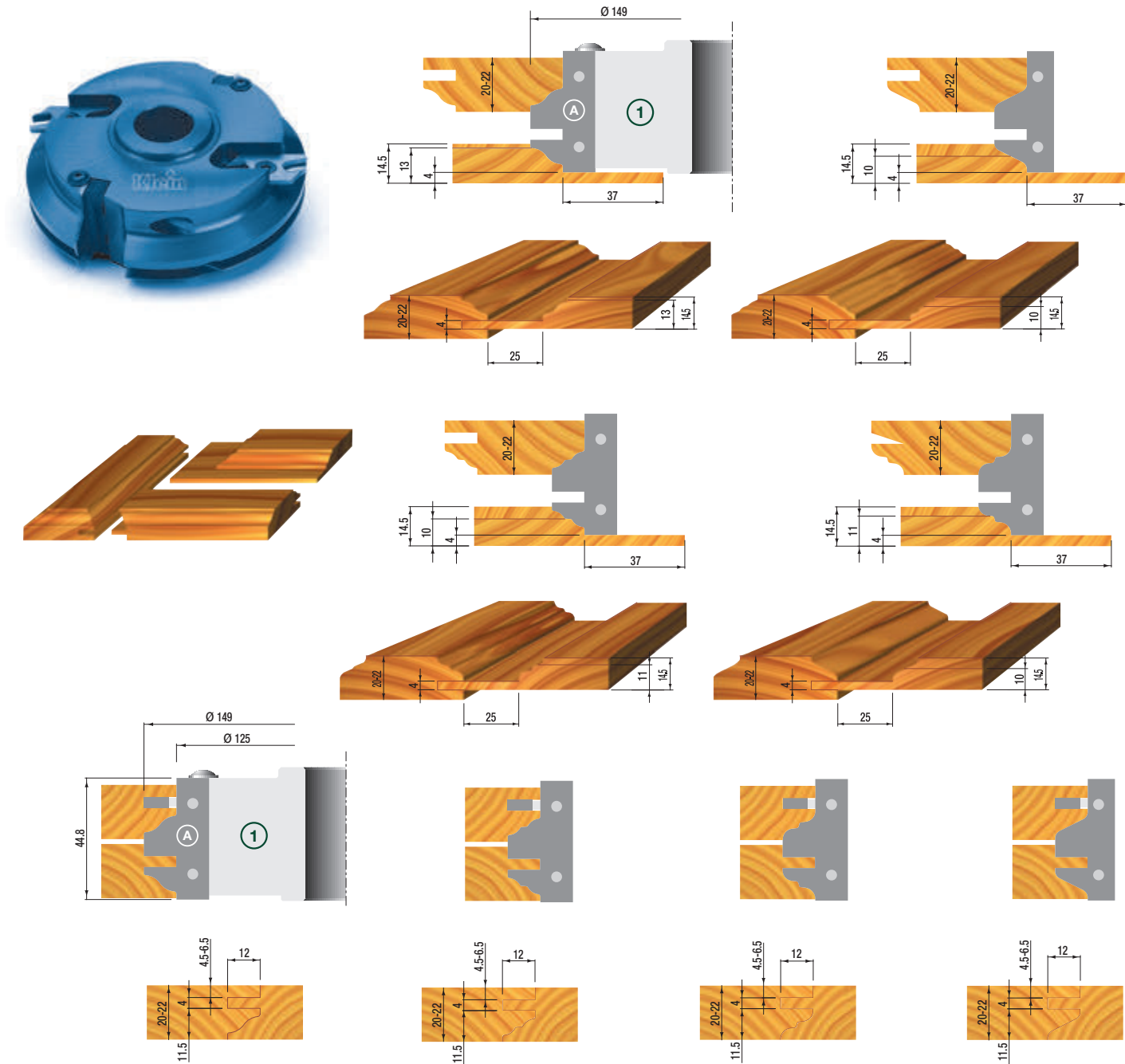

- Very versatile for the production of the door, profile, counterprofile and panel raising
- Light alloy with HW knives
- Same tool body fits four different profiled knives
- Manual feed (MAN)

Item	D	d	B	Profile	Z
TUL150.45130 selling out	149	30	44,8	A	2+2
TUL150.45230 selling out	149	30	44,8	B	2+2
TUL150.45330 selling out	149	30	44,8	C	2+2
TUL150.45430 selling out	149	30	44,8	D	2+2

Spare parts:

	Dimension	Item
Profile knife	Prof. "A"	Z055.837.R
Profile knife	Prof. "B"	Z055.838.R
Profile knife	Prof. "C"	Z055.839.R
Profile knife	Prof. "D"	Z055.840.R
Wedge	-	Z056.720N
Wedge screw	M8X20	Z051.805.R
Spare knife	40X4 - Dx	Z061.000.R
Screw	M6x15	Z051.703.R

HW PANEL RAISING SET

ART. TWL

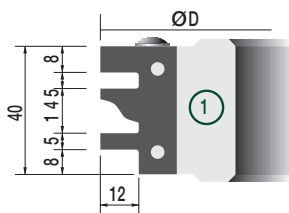

Profile "A"

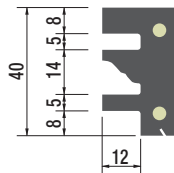

Profile "B"

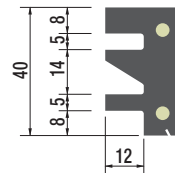

Profile "C"

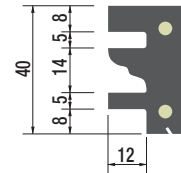

Profile "D"

- Cutterhead for profile and counter profile cutting
- Produced in light alloy with HW knives and shear angle
- The tool body fits 4 different profile knives
- Manual feed (MAN)
- Available also with bore 35/40/50

Item	D	d	B	Profilo	Z
TWL120.40130	120	30	40	A	2
TWL120.40230	120	30	40	B	2
TWL120.40330	120	30	40	C	2
TWL120.40430	120	30	40	D	2

TWL120 diameter 120 mm. bore 35 mm. (code number ends with 35 instead of 30)

TWL120 diameter 120 mm. bore 40 mm. (code number ends with 40 instead of 30)

Spare parts:

	Dimension	Item
Profile knife	profile "A"	Z055.843.R
Profile knife	profile "B"	Z055.844.R
Profile knife	profile "C"	Z055.845.R
Profile knife	profile "D"	Z055.846.R
Wedge	-	Z056.723.N
Wedge screw	M6X25	Z051.808.R

HW PANEL RAISING SET

ART. TVL

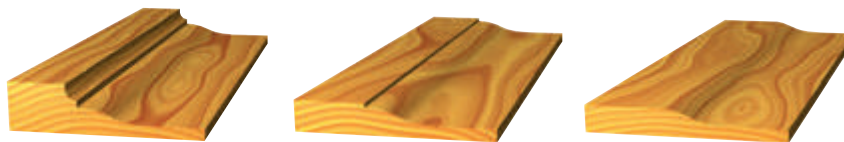
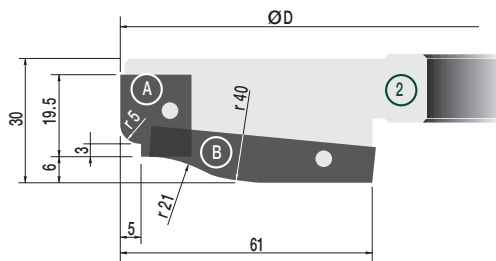

- Produced in light alloy with HW knives
- Manual feed (MAN)
- Available also with bore 35/40/50

Item	D	d	B	Z
TVL185.30030	185	30	30	2+2
TVL185.30035	185	35	30	2+2

Spare parts:

	Dimension	Item
Profile knife	profile "A"	Z055.841.R
Wedge	-	Z056.721.N
Wedge screw	M6X25	Z051.808.R
Profile knife	profile "B"	Z055.842.R
Wedge	-	Z056.722.N
Wedge screw	M6X25	Z051.808.R

COUNTERPROFILE-RAISING PANEL SET

ART. TX

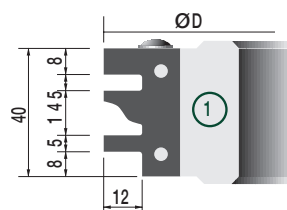
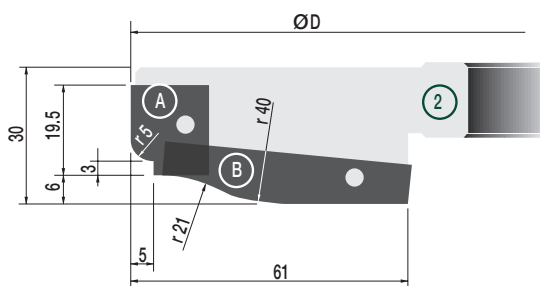

Complete with: **TVL185.30030**
TWL120.40130

Item	
TX0012	Counterprofile-raising panel set in plastic box (on request bore 35/40/50)

HW TOOLING SET FOR PROFILES AND COUNTERPROFILES

ART. TYL

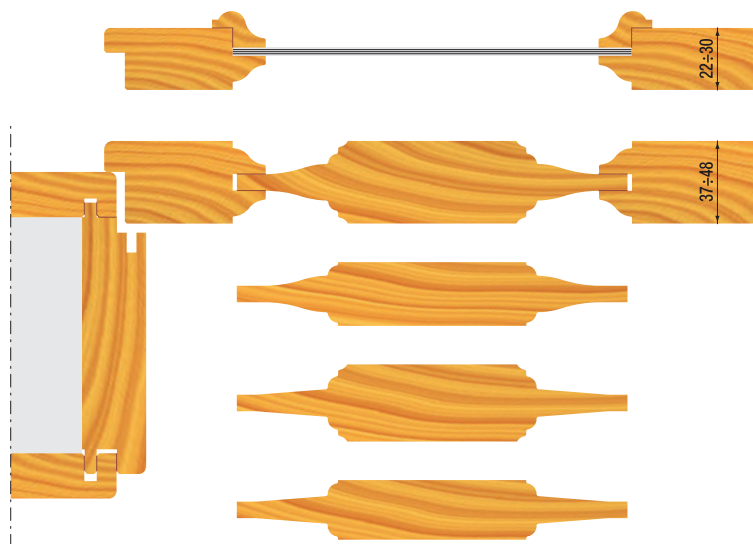

- Tool set for the production of doors (profile and counterprofile)
- Produced in light alloy with HW knives
- Complete with 3 cutterheads, adjustment spacer rings and two safety flanges
- The adjustable groover can be used separately
- Manual feed (MAN)
- **Available also with bore 35**

Item	D	d	B	Profile	V	Z
TYL132.25130	132	30	50	A1+A2	2	4
TYL132.25230	132	30	50	B1+B2	2	4
TYL132.25330	132	30	50	C1+C2	2	4
TYL132.25430	132	30	50	D1+D2	2	4
TYL132.25530	132	30	50	E1+E2	2	4

TYL132 diameter 132 mm. bore 35 mm. (code number ends with 35 instead of 30)

Spare parts:

	Dimension	Item
Profile knife	Prof. "A1"	Z055.851.R
Profile knife	Prof. "A2"	Z055.852.R
Profile knife	Prof. "B1"	Z055.853.R
Profile knife	Prof. "B2"	Z055.854.R
Profile knife	Prof. "C1"	Z055.855.R
Profile knife	Prof. "C2"	Z055.856.R
Profile knife	Prof. "D1"	Z055.857.R
Profile knife	Prof. "D2"	Z055.858.R
Profile knife	Prof. "E1"	Z055.859.R
Profile knife	Prof. "E2"	Z055.860.R
Wedge for A1-B1-C1-D1-E1	-	Z056.724.N
Wedge for A2-B2-C2-D2-E2	-	Z056.725.N
Wedge screw	M6X20	Z051.807.R

HW TOOLING SET FOR PROFILES AND COUNTERPROFILES EXAMPLES

ART. TYL

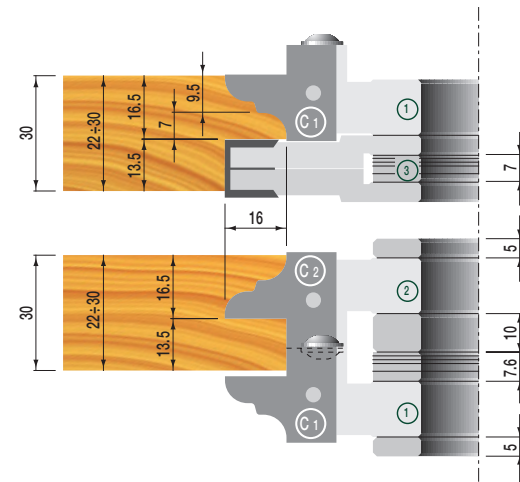
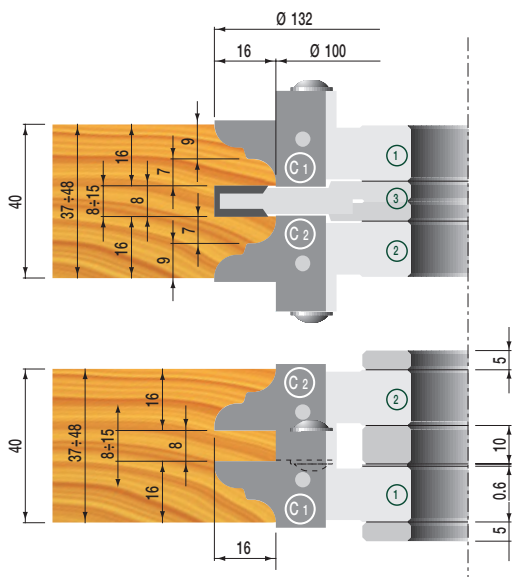
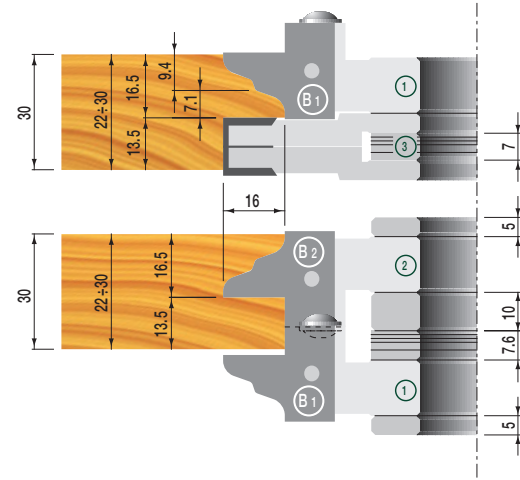
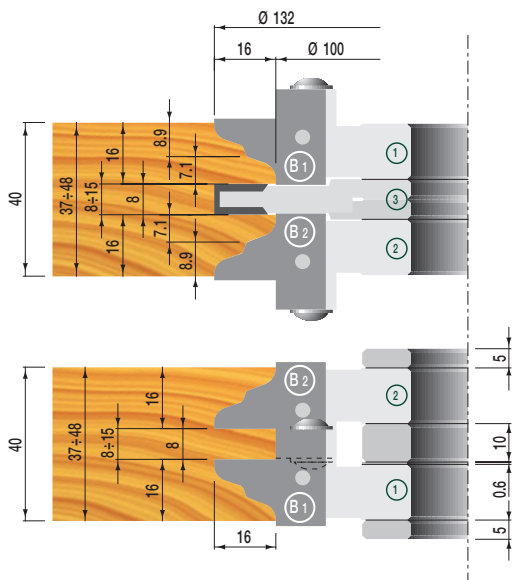
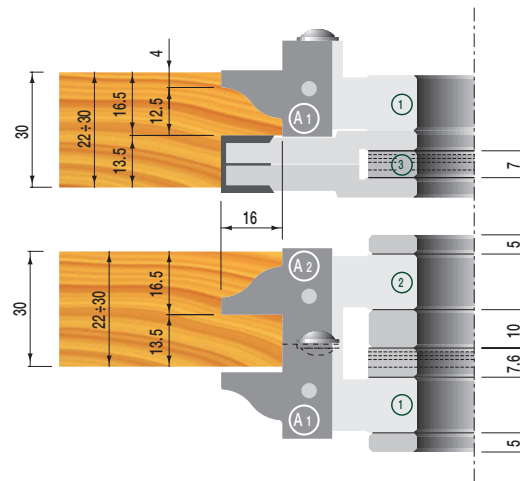
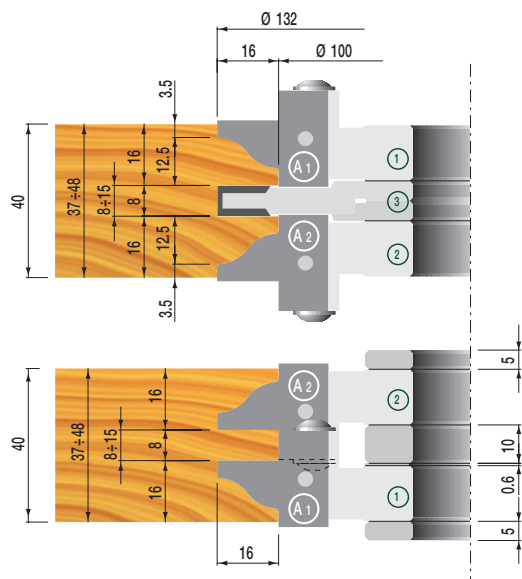

HW TOOLING SET FOR PROFILES AND COUNTERPROFILES EXAMPLES

ART. TYL

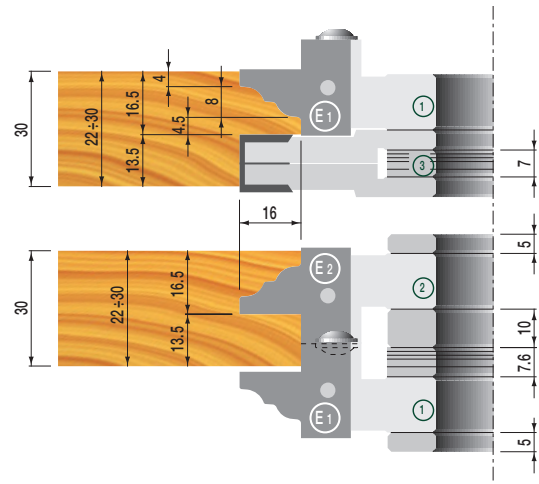
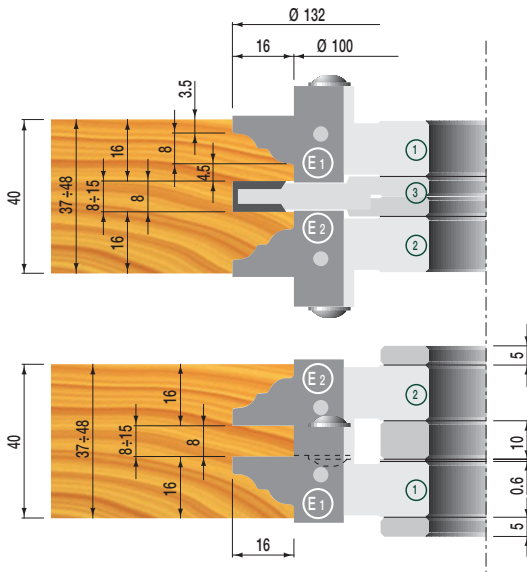
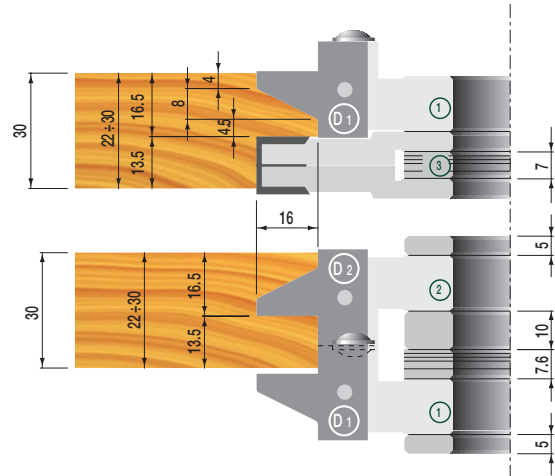
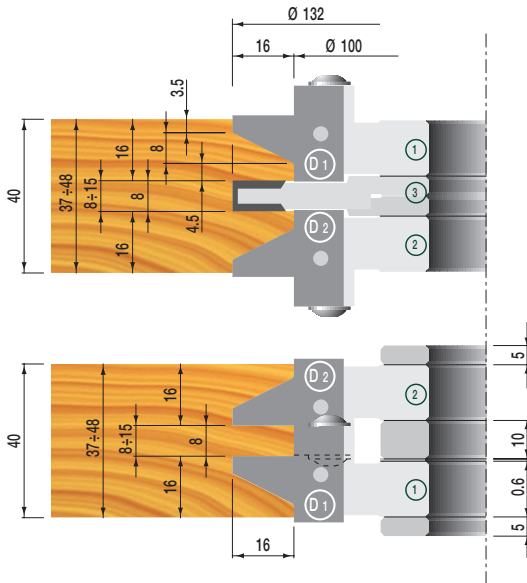

TONGUE AND GROOVE TOOLING SET

ART. TZL

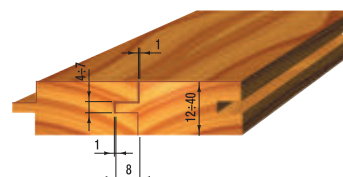
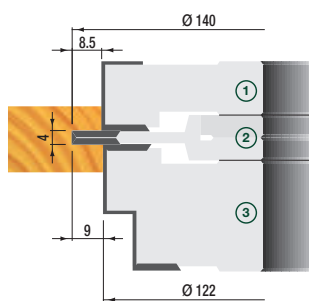
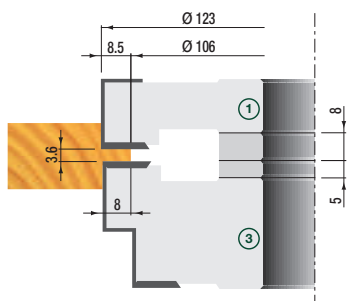
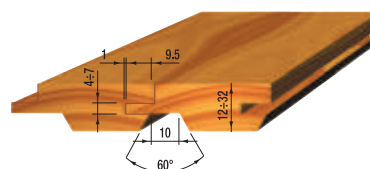
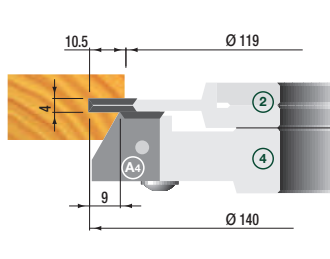
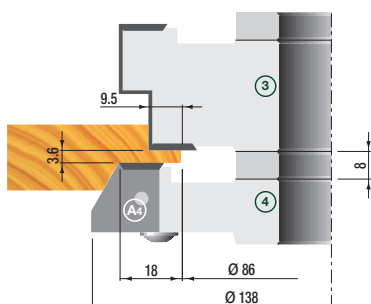
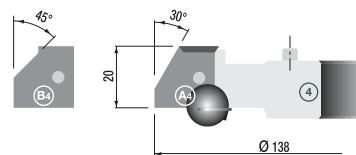
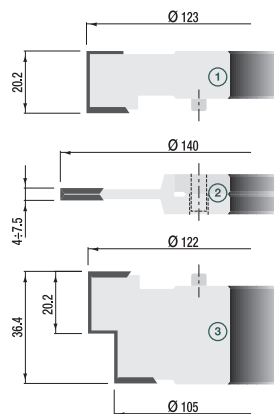
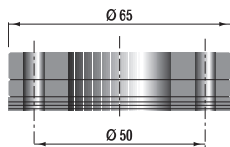

- Tool set for production of wall panels and various types of flooring
- Produced in light alloy with HW knives
- Complete with 4 cutterheads and spacers rings, packed in plastic case
- Manual feed (MAN)
- Available only with bore 30

Item	D	d	Bmax	Z	V
TZL138.40030	138	30	40	2	4
TZL138.40035	138	35	40	2	4

Spare parts:

	Dimension	Item
Knife "1"	20x12x1,5	Z055.003.N
Knife "3"	20x12x1,5	Z055.003.N
Wedge	-	Z056.708.N
Wedge screw	M8x20	Z051.805.R
Spur "1"	14x4x2	Z055.007.N
Spur "3"	14x4x2	Z055.007.N
Spur screw	M5x7	Z051.701.R
Knife "4"	prof. "A4"	Z055.847.R
Knife "4"	prof. "B4"	Z055.848.R
Wedge	-	Z056.708.N
Wedge screw	M8x20	Z051.805.R
Spur "4"	14x4x2	Z055.007.N
Spur screw	M5x7	Z051.701.R

HW PLANERHEAD

ART. TZA

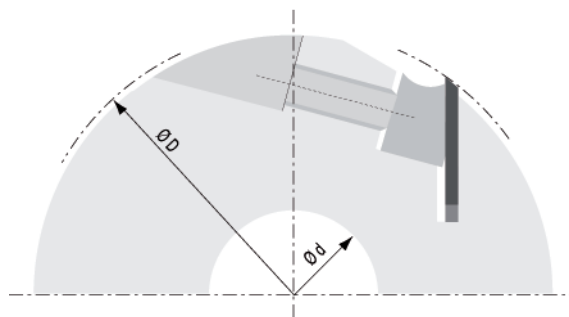

- Cutterhead in steel with HS knives (18%W) - 30x3
- Planer knives positioning by means of aligners Art. Y200.125.N (page....)
- Can be equipped with HW knives on request
- Can be also produced in light alloy

Item	D	d	B	Z
TZA125.12035	125	35	120	4
TZA125.12040	125	40	120	4
TZA125.13035	125	35	130	4
TZA125.13040	125	40	130	4
TZA125.15035	125	35	150	4
TZA125.15040	125	40	150	4
TZA125.18040	125	40	180	4
TZA125.23035	125	35	230	4
TZA125.23040	125	40	230	4

Spare parts:

Item

Z056.760.N	Wedge L= 120
Z056.761.N	Wedge L= 130
Z056.762.N	Wedge L= 150
Z056.763.N	Wedge L= 180
Z056.764.N	Wedge L= 230
Z051.809.R	Wedge screw M8x18
Z060.100.N	Pressure spring

GUIDE BALL BEARINGS FOR SAWING OUT

ART. Z050

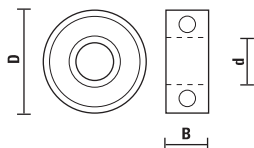

To be used with guide rings Art. Z058

Item	D	d	B
Z050.500.N	62	30	16

GUIDE RINGS FOR BALL BEARING

ART. Z058

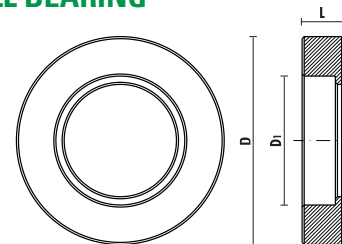

- Guide rings in **light alloy**
- Safety ring in **steel**

Item	D	D1	L	
Z058.501.N	70	62	21,5	
Z058.502.N	75	62	21,5	
Z058.503.N	80	62	21,5	
Z058.504.N	85	62	21,5	
Z058.505.N	90	62	21,5	
Z058.506.N	95	62	21,5	
Z058.507.N	100	62	21,5	
Z058.508.N	105	62	21,5	
Z058.509.N	110	62	21,5	
Z058.510.N	115	62	21,5	
Z058.511.N	120	62	21,5	
Z058.512.N	125	62	21,5	
Z058.900.N	Safety ring	68	30	21,5

REDUCTION RINGS FOR CUTTERHEADS

ART. ZA010

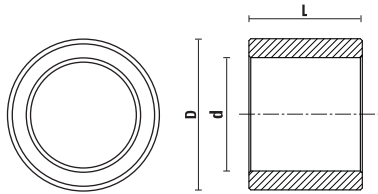

Tolerance:
D= 0/- 0,02
D1= + 0,02/0
L= ± 0,02

Item	D	D1	L
ZA010.322020 NEW	32	20	20
ZA010.353005 NEW	35	30	5
ZA010.353010 NEW	35	30	10
ZA010.353015 NEW	35	30	15
ZA010.353020 NEW	35	30	20
ZA010.353025 NEW	35	30	25
ZA010.353030 NEW	35	30	30
ZA010.353035 NEW	35	30	35
ZA010.353040 NEW	35	30	40
ZA010.403005 NEW	40	30	5
ZA010.403010 NEW	40	30	10
ZA010.403015 NEW	40	30	15
ZA010.403020 NEW	40	30	20
ZA010.403025 NEW	40	30	25
ZA010.403030 NEW	40	30	30
ZA010.403035 NEW	40	30	35
ZA010.403040 NEW	40	30	40
ZA010.403505 NEW	40	35	5
ZA010.403510 NEW	40	35	10
ZA010.403515 NEW	40	35	15
ZA010.403520 NEW	40	35	20
ZA010.403525 NEW	40	35	25
ZA010.403530 NEW	40	35	30
ZA010.403535 NEW	40	35	35
ZA010.403540 NEW	40	35	40

REDUCING BUSHES

ART. ZA011

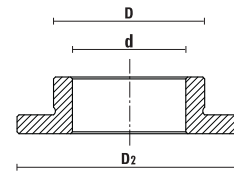

Tolerance:
D= 0/- 0,02
D1= 0/- 0,02

Item	D	D1	D2
ZA011.03530 NEW	35	30	55
ZA011.04030 NEW	40	30	60
ZA011.14035 NEW	40	35	55
ZA011.05030 NEW	50	30	70
ZA011.15035 NEW	50	35	70
ZA011.25040 NEW	50	40	70

BALL BEARING WITH BUTTING RING SET

ART. TX

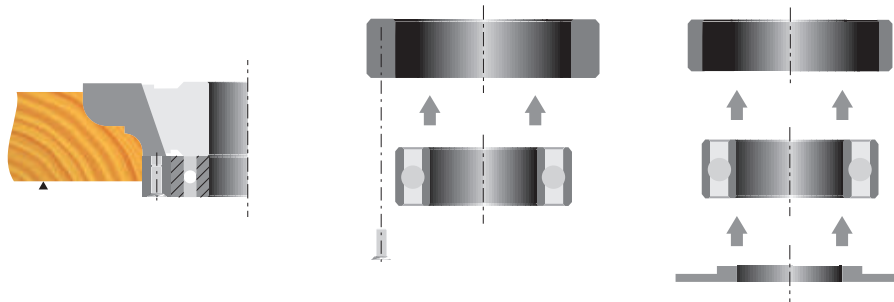

Item	
TX0050	
Complete with 6 pcs.:	
Z050.500.N - 1 ball bearing	Z058.507.N - 1 guide ring D=100
Z058.501.N - 1 guide ring D=70	Z058.511.N - 1 guide ring D=125
Z058.505.N - 1 guide ring D=90	Z058.900.N - 1 safety ring D=68

Lubricants, diamond grinding wheels, diamond stones

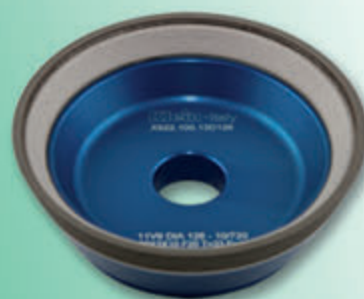

14



KLEIN TOPUP
Pag. 14.03



KLEIN DRYUP
Pag. 14.03



KLEIN PROTECT
Pag. 14.03



KLEIN CLEANUP
Pag. 14.03



KLEIN WASHER
Pag. 14.03



KLEIN CLEANER
Pag. 14.03



4" DIAMOND WHETSTONE
Pag. 14.04



4" DIAMOND WHETSTONE
Pag. 14.04



MACHINIST POCKET WHETSTONE
Pag. 14.04



MACHINIST POCKET WHETSTONE
Pag. 14.04



MACHINIST POCKET WHETSTONE
Pag. 14.05



DIAFOLD DIAMOND WHETSTONE
Pag. 14.05



DIAFOLD DIAMOND FLAT FILE
Pag. 14.05



DIAFOLD SERRATED KNIFE SHARPENER
Pag. 14.05



6"/8"/12" DIAMOND WHETSTONE
Pag. 14.06



DEMO-STAND
Pag. 14.06



**DIAMOND WAVE SHARPENERS FOR
RADIUS CUTTERS**
Pag. 14.07



**8" DIAMOND WHETSTONE
WITH BASE**
Pag. 14.07

Klein®



DIAMOND WHETSTONE
Pag. 14.07



DIAMOND WHETSTONE
Pag. 14.07



GRINDING WHEEL FOR ROUNDED
SPURS DOWEL DRILLS
Pag. 14.08



GRINDING WHEEL
FOR DOWEL DRILLS
Pag. 14.08



HIGH PERFORMANCE CUTTING DISC
Pag. 14.09



GRINDING WHEEL FOR HOLLOW
PARTS AND HOLES
Pag. 14.09

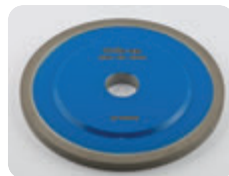

GENERAL PURPOSE STRAIGHT WHEEL
Pag. 14.09



GENERAL PURPOSE
STRAIGHT WHEEL
Pag. 14.09



GRINDING WHEEL
FOR HW TIPPED CUTTERS
Pag. 14.09



GRINDING WHEEL
FOR PLANER KNIVES
Pag. 14.09



GRINDING WHEEL
FOR ROUTER CUTTERS
Pag. 14.10



GRINDING WHEEL
FOR ROUTER CUTTERS
Pag. 14.10



GRINDING WHEEL FOR HW TIPPED
SAWBLADES
Pag. 14.10



GRINDING WHEEL FOR HW TIPPED
SAWBLADES
Pag. 14.10



GRINDING WHEEL FOR BAND SAWBLADES
Pag. 14.10

The best for a proper maintenance

KleinTOPUP

Table and tool surface sealant



- Eliminates "hang-ups" on sliding surfaces
- Protects all tools and equipment from rust.
- Up to 30% slicker than paste wax.
- Prevents rust 5 times longer than paste wax or silicone.
- Easier and quicker to apply
- Contains no silicone or petroleum oil.
- Will not stain wood or interfere with glues or finishes.
- Perfect for table saws, drill presses, lathes, planers, band saws, mitres, panel saws and all hand tools.
- Environment-friendly, doesn't contain CFCs or any other ODS.

Item	Description
KLEINTOPUP.400 NEW	Spray Can 400 ml.

KleinDRYUP

Blade and bit cutting lubricant



- Prevents resin build-up.
- Reduces blade cleanings.
- Extends overall life of blades and bits by up to 3 times!
- More than doubles time between resharpenings.
- Contains NO silicone or petroleum oil. Will NOT stain wood or interfere with glues or finishes.
- Reduces cutting friction and heat by 30%.
- Prolongs equipments life by reducing saw or drill motor drag by up to 25%.
- Increases productivity by less downtime for saw blade changeovers.
- Works equally well on steel or carbide, stellite and diamond-tipped cutting blades.
- Environment-friendly, doesn't contain CFCs or any other ODS.

Item	Description
KLEINDRYUP.400 NEW	Spray Can 400 ml.

KleinPROTECT

Protective lubricant for cutting tools



- Removes easily and rapidly any residues of grease, coolants and synthetic compounds.
- If regularly used, protects and prevents from rust and corrosion
- Displaces moisture and condensation in case of difficult weather conditions.
- Extremely efficient on every metal surface
- Can be applied also on alloys containing copper, magnesium, nickel, steel, stainless steel, titanium and zinc, or polymers and elastomers.
- Can be used on all types of delicate machinery and mechanisms for weapons (according to U.S. Army specifications).

Item	Description
KLEINPROTECT.400 NEW	Spray Can 400 ml.
KLEINPROTECT.5000 NEW	Liquid – Tank 5 L

KleinCLEANUP

Detergent for cutting tools cleaning



- Water-based detergent for clearing tools
- Recommended for removing resin or sludge from tools
- No corrosive or dulling effect
- Not foaming
- Not flammable, doesn't contain solvents
- Non-toxic, not health-harming
- Biodegradable
- Suitable also for washers
- Can be used on any mechanical parts or tools also mounted on groups for windows

Item	Description
KLEINCLEANUP.1000 NEW	Liquid – Bottle 1 L
KLEINCLEANUP.10000 NEW	Liquid – Tank 10 L

KleinWASHER

Automatic Tool Washer

- Suitable for washing any metal parts
- For tools of various dimensions, also for tool groups for windows
- Heated biological operating mode

Includes:

- Stainless steel housing
- Rotating tank D=550 mm.
- Stainless steel upper, under and lateral washing arms
- Timer
- Thermal resistance
- Single-phase 1 hp pump
- Dimensions: 700x600 h 866mm.
- Dimensions packing: 785x780 h1000mm.
- Weight: 50 kg.



Item
KLEINWASHER NEW

See section 16 page 16.19

KleinCLEANER

Manual Tool Washer

- Can wash any type of tools or metal parts
- Easy to be used with water and spray gun
- Heated biological operating mode

Includes:

- Spray gun
- Tool holding grid
- Stainless steel tank with thermal resistance
- Air-operated double diaphragm pump 5 L/min.
- Tank dimensions: 600x500 h 250mm.
- Tank capacity: 70L
- Dimensions: 700x560 h1000mm.
- Dimensions packing: 970x670 h1020.
- Weight: 40 Kg.



Item
KLEINCLEANER NEW

See section 16 page 16.19

DIAMOND WHETSTONE



Grind and spare!

A complete range of diamond stones for any kind of application
JUST DIAMOND CAN GIVE YOU THE EDGE OF PERFECTION

- FAST** - Hardest material; most efficient sharpening abrasive
- EASY** - Light pressure produces a sharp edge with just a few strokes
- CLEAN** - Use water for lubricant - No oil, no mess!
- VERSATILE** - Hones all hard materials: carbide, steel, etc.
- DURABLE** - Stays flat



- **X-Coarse** Most rapid stock removed for dressing nicked or damaged knives and chisels or sharpening heavy cutting tools such as axes and lawnmower blades.
- **Coarse** Rapidly restores a sharp edge on dull knives and tools. Perfect for honing garden tools, sport knives, scissors and general tools.
- **Fine** Ideal for honing a razor sharp edge on quality cutlery and woodworking tools that are regularly maintained.
- **Extra-Fine** the ultimate edge refinement for the finest quality knives and woodworking tools. Recommended after edge has been sharpened on the grit.

4" DIAMOND WHETSTONE

ART. W4

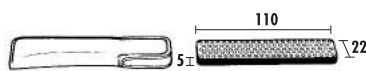

In leather sheath



Item	Grit sizing
W4E	Extra-fine
W4F	Fine
W4C	Coarse
W4X	X-Coarse



4" DIAMOND WHETSTONE

ART. A4

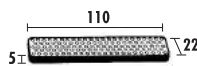

In plastic package



Item	Grit sizing
A4E	Extra-fine
A4F	Fine
A4C	Coarse
A4X	X-Coarse

MACHINIST POCKET WHETSTONE

ART. WM

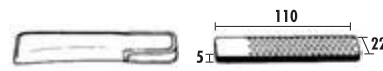

- In leather sheath
 - Ideal for resharpening small size tools



Item	Grit sizing
WMF	Fine
WMC	Coarse

MACHINIST POCKET WHETSTONE

ART. WS7

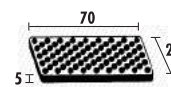

In plastic package



Item	Grit sizing
WS7E	Extra-fine
WS7F	Fine
WS7C	Coarse
WS7X	X-Coarse



MACHINIST POCKET WHETSTONE

ART. F70

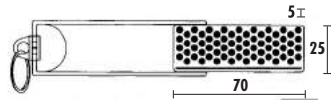

In plastic package



Item	Grit sizing
F70F	Fine
F70C	Coarse



DIAFOLD DIAMOND WHETSTONE

ART. FW

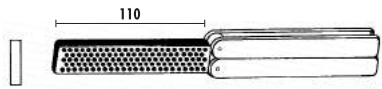

Diafold sharpeners with folding plastic handles



Item	Grit sizing
FWE	Extra-fine
FWF	Fine
FVC	Coarse
FWX	X-Coarse

FWEF	Ex.-fine/fine
FWFC	Fine/Coarse
FWCX	Coarse/ X-Coarse



DIAFOLD DIAMOND FLAT FILE

ART. FF

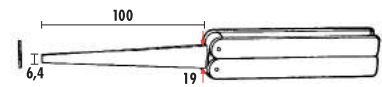

Pocket diafold diamond flat file



Item	Grit sizing
FFF	Fine
FFC	Coarse

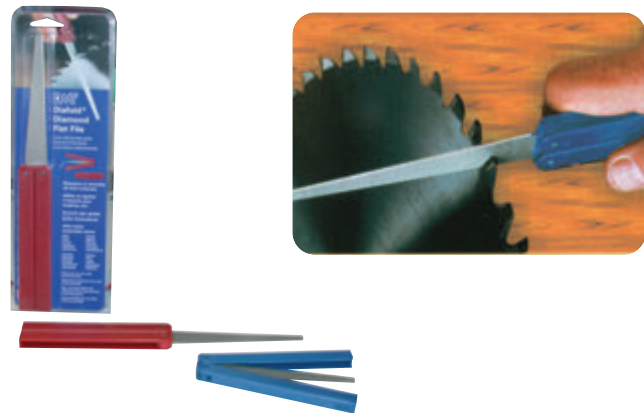

DIAFOLD SERRATED KNIFE SHARPENER

ART. FSK

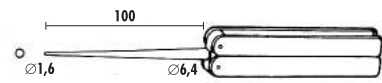

Pocket diafold conical diamond file



Item	Grit sizing
FSKF	Fine
FSKC	Coarse



6"/8"/12" DIAMOND WHETSTONE

ART. W6 - W8 - WT

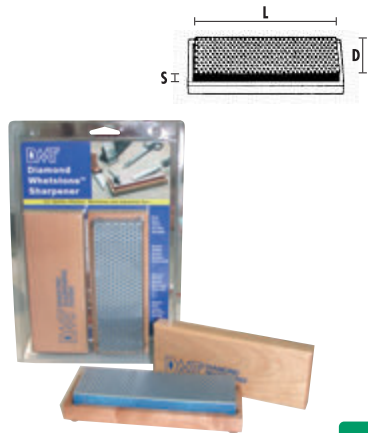

Bench model in hardwood case

Item	Grit sizing	L	D	S
W6E	Extra-fine	152	51	19
W6F	Fine	152	51	19
W6C	Coarse	152	51	19
W6X	X-Coarse	152	51	19
W8E	Extra-fine	205	67	32
W8F	Fine	205	67	32
W8C	Coarse	205	67	32
W8X	X-Coarse	205	67	32
WTF	Fine	305	67	32
WTC	Coarse	305	67	32

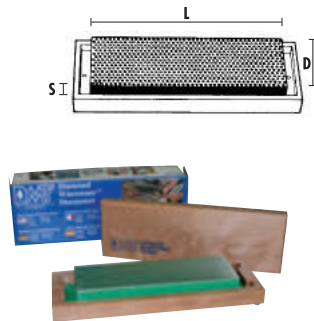
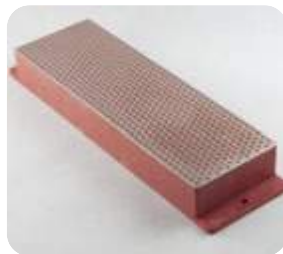

Bench model in plastic case

Item	Grit sizing	L	D	S
W6EP	Extra-fine	152	51	19
W6FP	Fine	152	51	19
W6CP	Coarse	152	51	19
W6XP	X-Coarse	152	51	19
W8ENB	Extra-fine	205	67	32
W8FNB	Fine	205	67	32
W8CNB	Coarse	205	67	32
W8XNB	X-Coarse	205	67	32



DEMO-STAND

ART. PDW6



- Demo stand including a diamond whetstone
- Supplied free of charge when ordering **two pieces** each of the following items

ART. F70F
ART. F70C



ART. W6F
ART. W6C



ART. W4F
ART. W4C



ART. FWF
ART. FWC



Item	Grit sizing	Dimension
PDW6F	Fine	152x51x19
PDW6C	Coarse	152x51x19

NEW DEALER STARTER KITS

Pcs	Item
1	PDW6C
2	W6FP
2	W6CP
2	F70F
2	F70C
2	FWE
2	FWF
2	FWC
2	FSKC

DIAMOND WAVE SHARPENERS FOR RADIUS CUTTERS

ART. WAVF

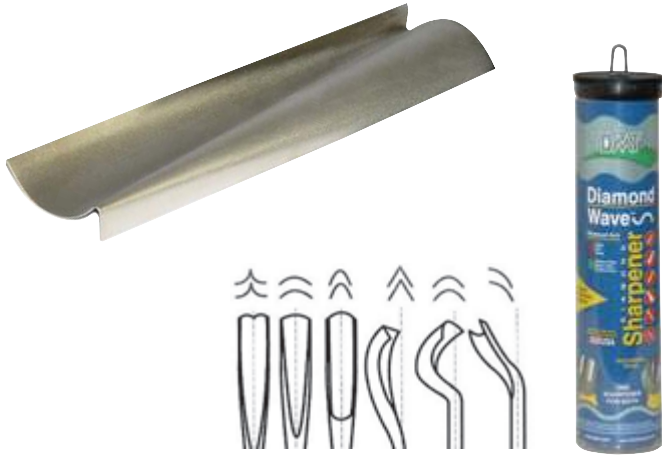

- DIAMOND WAVE

- Ideal for resharpening curved tools, like gouges, carving and wood turning tools
- Convex and concave diamond surface in one sharpening tool
- Resharpen tools with radius from min. 1,6 to max. 25 mm.
- Including anti-slippery pad for easier use
- No oil is needed – sharpen dry or with water



Item	Grit sizing	Dimension
WAVF	Fine	30x250x25

8" DIAMOND WHETSTONE WITH BASE

ART. WM8FC-WB



- DUOSHARP

- Double-sided stone:
- Coarse grit to quickly restore a neglected edge
- Fine grit for a razor sharp edge
- Ideal for all craftsmen who need to resharpen straight cutting edges
- Can resharpen a wide range of materials: carbide, steel, ceramic, glas, stone
- Supplied with plastic base



Item	Grit sizing	Dimension
WM8FC-WB	Coarse/Fine	203x66 mm

Spare parts

WM8FC	Coarse/Fine	203x66 mm
-------	-------------	-----------



NEW DIAMOND SHARPENERS "ECONOMY LINE"



Sharpens, hones & laps: knives, router bits, plane blades, ski edges, fish hooks, garden tools, chisels, scissors, sawblades, lapidary, ceramics, broadheads, climbing equipment, masonry drills, axes, engraving tools, farm tools, mold & dies, planer/jointer knives, speed skates, carbide, glass.

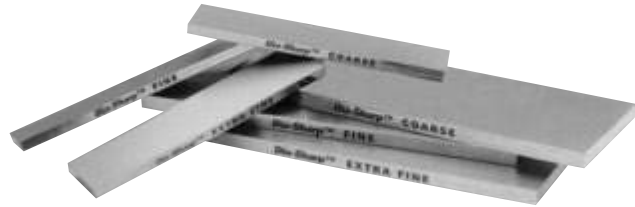

- COARSE (C) - 45 micron**
General use-rapidly restores a dull edge on a tool or knife
- FINE (F) - 25 micron**
Restores a razor edge on well maintained tools and knives
- Ex-FINE (E) - 9 micron**
The ultimate edge refinement after stock removal on coarser diamond

DIAMOND WHETSTONE

ART. D4



In plastic package



Item	Grit sizing	Dimension
D4E	Extra-fine	110x22x5
D4F	Fine	110x22x5
D4C	Coarse	110x22x5

DIAMOND WHETSTONE

ART. D6



In plastic package



Item	Grit sizing	Dimension
D6E	Extra-fine	150x50x6
D6F	Fine	150x50x6
D6C	Coarse	150x50x6

GRINDING WHEELS



As a result of long experience in the production of special, high precision tools, **SISTEMI** has developed the Super Diamond **Klein**, which allows performing quicker and more economically efficient abrasive machining operations. Obtained by a process of synthesis to very high pressure and temperature, the diamond used in the grinding wheels **Klein** is artificial and has been tested to provide the best possible result on the machines for regrinding tools for woodworking, while for ferrous materials, such as tools in HSS, CBN (Cubic boron nitride) is used.

The choice of grain size plays also an important role and **SISTEMI** has decided to limit the amount of grains available in its program by choosing those with the best performance of most use.

The grains of diamond or CBN are agglomerated with different binders, classified according to the following characteristics:

- Capacity of particle retention
- Capacity of discharging worn grains
- Dressing capacity
- Thermal resistance
- Thermal conductivity
- Type of material to be processed

The attention to component selection and manufacturing process ensures that **Klein** grinding wheels are products of high precision. Mounting flanges, back-plates or adapters must be absolutely used and kept in good condition. All possible defects in the wheel-arbor coupling must be corrected before starting the wheel.

Furthermore it is important to remember that the use of coolant increases the cutting performance of the grinding wheels, reducing friction, heat generation and jamming of the abrasive surface.

Our Super Diamond **Klein** can be supplied in different shapes or dimensions on request, as well as in other grain sizes or bond types.

GRINDING WHEEL FOR ROUNDED SPURS DOWEL DRILLS

ART. X900

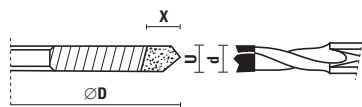

- Type 1A1 SPECIAL
- Abrasive material
- Grain size D91
- Suitable for Art. L114 - L115 - L116 - L117

Item	Tool diam.	ØD	Bore	U	X
X900.125.05D91	3÷7	125	20	5,5	8
X900.125.07D91	8÷10	125	20	7	8

GRINDING WHEEL FOR DOWEL DRILLS

ART. X901

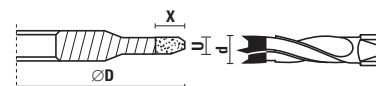

- Type 14A1 SPECIAL
- Abrasive material
- Grain size D91
- Suitable for Art. L101 - L102 - L103 - L104 - L105 - L106 - L107 - L108 - L109 - L110

Item	Tool diam.	ØD	Bore	U	X
X901.125.04D91	4	125	20	4	8
X901.125.05D91	5	125	20	4,5	8
X901.125.06D91	6	125	20	4,5	8
X901.125.08D91	8	125	20	5	8
X901.125.10D91	10	125	20	6	8

HIGH PERFORMANCE CUTTING DISC

ART. X902

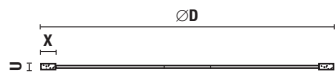

- Type 1A1R
- Abrasive material
- Grain size D181

Item	ØD	Bore	U	X
X902.125.12D181	125	20	1,2	6
X902.150.12D181	150	20	1,2	6

GRINDING WHEEL FOR HOLLOW PARTS AND HOLES

ART. X903

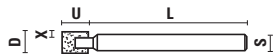

- Type 1A1W
- Abrasive material
- Grain size D126

Item	D	U	X	S	L
X903.006.06D126	6	6	1,5	6	60
X903.008.06D126	8	6	2	6	60
X903.010.06D126	10	6	2	6	60
X903.012.06D126	12	6	2	6	60

GENERAL PURPOSE STRAIGHT WHEEL

ART. X904

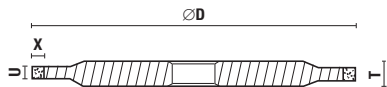
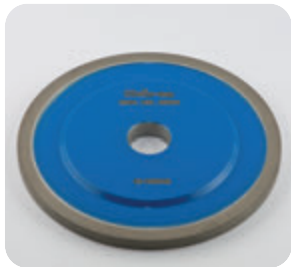

- Type 14A1
- Abrasive material
- Grain size D91

Item	ØD	Bore	U	X	T
X904.075.46D91	75	20	4	6	8
X904.075.66D91	75	20	6	6	10
X904.075.86D91	75	20	8	6	12
X904.100.46D91	100	20	4	6	8
X904.100.66D91	100	20	6	6	10
X904.100.86D91	100	20	8	6	12
X904.125.66D91	125	20	6	6	10
X904.125.86D91	125	20	8	6	12

GENERAL PURPOSE STRAIGHT WHEEL

ART. X905

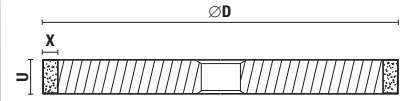

- Type 1A1
- Abrasive material
- Grain size D91

Item	ØD	Bore	U	X
X905.125.10D91	125	20	10	6
X905.125.12D91	125	20	12	6

GRINDING WHEEL FOR HW TIPPED CUTTERS

ART. X920

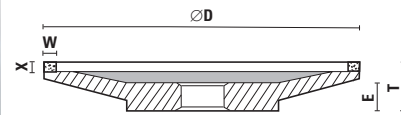

- Type 12A2 20°
- Abrasive material
- Grain size D64

Item	ØD	Bore	W	X	T	E
X920.150.46D64	150	20	6	4	21	9

GRINDING WHEEL FOR PLANER KNIVES

ART. X921

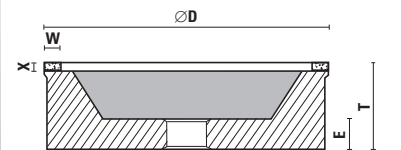

- Type 6A2
- D91 diamond type for HW knives
- Carborundum (CBN) B151 for HS knives

Item	ØD	Bore	W	X	T	E	Grain size	Abrasive
X921.125.45D91	125	16	5	4	40	16	D91	DIA
X921.150.46D91	150	20	6	4	49	15	D91	DIA
X921.175.56D91	175	20	6	5	56	15	D91	DIA
X921.125.45B151	125	16	5	4	40	16	B151	CBN
X921.150.46B151	150	20	6	4	49	15	B151	CBN

GRINDING WHEEL FOR ROUTER CUTTERS

ART. X922

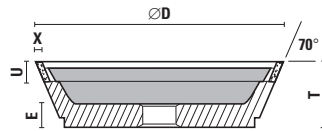
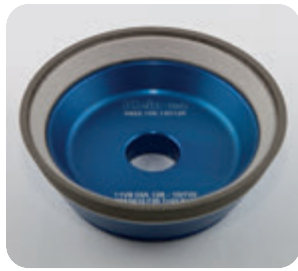

- Type 11V9
- Abrasive material
- Grain size D126
- For tool top and diameter regrinding
- For both HW straight router bits and solid carbide spiral router bits

Item	ØD	Bore	U	X	T	E
X922.075.13D126	75	20	10	3	30	11
X922.100.13D126	100	20	10	3	33	12

GRINDING WHEEL FOR ROUTER CUTTERS

ART. X923

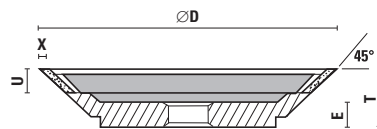
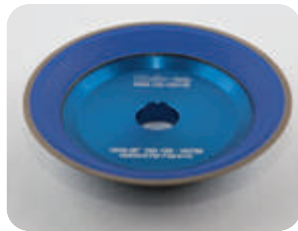

- Type 12V9 45°
- Abrasive material
- Grain size D126
- For tool face grinding on solid carbide spiral cutters

Item	ØD	Bore	U	X	T	E
X923.075.13D126	75	20	10	3	20	10
X923.100.13D126	100	20	10	3	25	11
X923.125.13D126	125	20	10	3	26	12

GRINDING WHEEL FOR HW TIPPED SAWBLADES

ART. X930

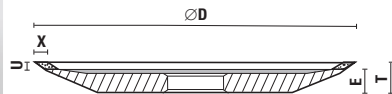

- Type 12V2
- Abrasive material
- Grain size D64
- Tooth face grinding
- Finishing grinding wheel

Item	ØD	Bore	X	U	T	E	Machine type
X930.075.24D64	75	25	4	2	10	8	Grifo AC66
X930.100.33D64	100	25 ch	3	3	11	8	Grifo AC90
X930.125.33D64	125	25 ch	3	3	12	8	Vollmer
X930.126.33D64	125	32	3	3	12	8	Vollmer CHC
X930.150.33D64	150	32	3	3	12	8	Ake
X930.175.33D64	175	50,8+1	3	3	12	12	Finimat
X930.200.33D64	200	32	3	3	12	11	Vollmer CHP

GRINDING WHEEL FOR HW TIPPED SAWBLADES

ART. X940

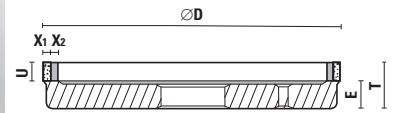
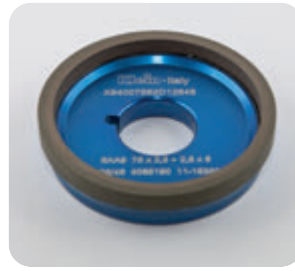

- Type 6AA9
- Abrasive material
- Grain size D126/46
- Tooth top grinding
- Double grain grinding wheel for single pass rough and finishing

Item	ØD	U	X1+X2	T	E	Bore	Machine type
X940.075.62D12646	75	6	2,5+2,5	17	9	25 ch	Grifo AC66
X940.100.82D12646	100	8	2,5+2,5	18	9	25 ch	Grifo AC90
X940.125.82D12646	125	8	2,5+2,5	20	11	32 ch	Voll. CHC - CHP
X940.126.82D12646	125	8	2,5+2,5	20	11	50,8+1	Finimat

GRINDING WHEEL FOR BAND SAWBLADES

ART. X950

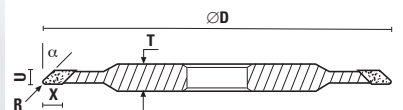

- Type 14VR
- Carborundum (CBN) grinding wheels
- Grain size B181
- For hardened steel and/or stellite

Item	ØD	U	X	T	R	α	Bore
X950.150.47B181	150	4	7	10	1	40°	20

Measuring instruments

15

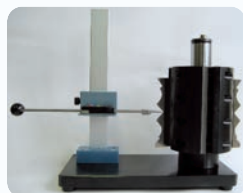

PRE SET P322
Page 15.03



CALIPER FOR CUTTER Z=3
Page 15.03



PRE SET LEADER
Page 15.04 - 15.05



PRE SET P368
Page 15.06 - 15.07



PRE SET P388
Page 15.08



PRE SET P382
Page 15.09



ANGOLFAST
Page 15.10

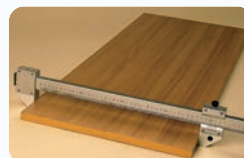

GAUGE FOR LINEAR MEASUREMENTS
Page 15.11



GAUGE FOR LINEAR MEASUREMENTS WITH STEEL PLATES
Page 15.11



GAUGE FOR DISTANCE BETWEEN HOLES
Page 15.12



GAUGE FOR 90° V-FOLD CUTS
Page 15.12



GAUGE FOR INSIDE/OUTSIDE MEASURING
Page 15.13

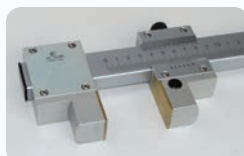

GAUGE FOR INSIDE/OUTSIDE MEASURING WITH STEEL PLATES
Page 15.13



GAUGE FOR LINEAR MEASUREMENTS AND DISTANCE BETWEEN CENTRES
Page 15.14

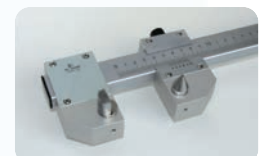

GAUGE FOR LINEAR MEASUREMENTS, DISTANCE FROM THE CENTRES OF THE HOLE TO THE EDGE OF THE PANEL
Page 15.14





GAUGE FOR LINEAR MEASUREMENTS,
WITH LONG JAWS
Page 15.15



GAUGE FOR LINEAR MEASUREMENTS,
WITH LONG JAWS AND STEEL PLATES
Page 15.15



GAUGE FOR 45° CUTS
Page 15.16



GAUGE FOR DIAGONAL AND OUT
OF SQUARE MEASUREMENTS
Page 15.16



OPTICAL LENS
Page 15.17



GAUGE CASE
Page 15.17



TEST REPORTER
Page 15.17

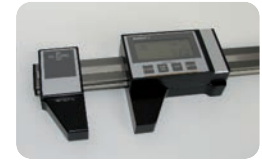

GAUGES FOR LINEAR MEASUREMENTS
Page 15.18



GAUGES FOR LINEAR-INSIDE/OUTSIDE
MEASUREMENTS
Page 15.18



GAUGE FOR LINEAR, INSIDE/OUTSIDE,
DISTANCE BETWEEN HOLES, OUT OF
SQUARE ANGLES MEASUREMENTS
Page 15.19



GAUGE FOR 45° CUTS
Page 15.19



GAUGE FOR LINEAR, INSIDE/OUTSIDE,
DISTANCE BETWEEN HOLES, OUT OF
SQUARE ANGLES MEASUREMENTS
Page 15.20

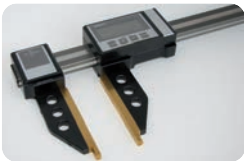

GAUGE FOR LINEAR MEASUREMENTS,
LONG JAWS
Page 15.21



GAUGE WITH NONIUS FOR
LINEAR-INSIDE/OUTSIDE
MEASUREMENTS, STEEL JAWS
Page 15.21



GAUGE WITH WIRELESS CONNECTION
FOR LINEAR MEASUREMENTS
Page 15.22



GAUGE WITH WIRELESS CONNECTION
FOR LINEAR, INSIDE/OUTSIDE,
DISTANCE BETWEEN HOLES,
OUT OF SQUARE ANGLES
MEASUREMENTS
Page 15.22



MAGNETIC STRIP MEASURING SYSTEM
Page 15.23



ELECTRONIC WORK STATION
Page 15.24 - 15.25

PRE SET P322

The radius measuring stand is a precision device of simple and quick use, suitable to measure the radius of profiled cutterheads. Before mounting the tools in a machine it is absolutely important to know the correct dimensions of the cutter and set them in order to start the production without any additional concerns.

The **Preset P322** was designed and developed in collaboration with technicians who work daily with these type of tools, having troubles with setting operations. The result is an optimization of the production and a good saving of time.

The **Preset P322** is the best accessory beside a moulding or a CNC machine.

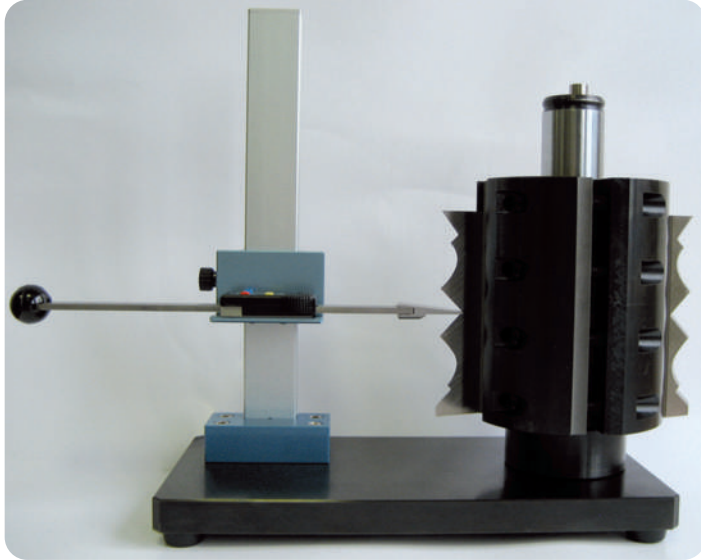

Main features
 Arbor height: 230 mm
 R max (cutterhead radius): 120 mm

Digital readout:
 Resolution: 0,01 mm
 Readout in mm/inches
 Battery-power (SR44)
 Operating temperature range: 0/+40°
 Storage temperature range: -10/+60°
 Umidity: ≤ 80%

Item	Ø Arbor	Height	R max
PRE-SET P322/30	30	230	120
PRE-SET P322/35	35	230	120
PRE-SET P322/40	40	230	120
PRE-SET P322/32	1" 1/4"	230	120
PRE-SET P322/38	1" 1/2"	230	120
PRE-SET P322/46	1" 13/16"	230	120

THREE POINT DIGITAL CALIPER FOR CUTTERS Z=3

ART. C.DIGIT.Z3

Caliper for measuring the diameter of router bits with three cutting edges (our items T143/T144, T153/T154 and any cutter Z=3)

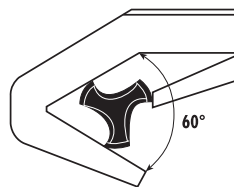

- Measuring range: 4 mm ÷ 40,00 mm / 0,16" ÷ 1,73"
- Resolution: 0,01 mm/0,0005"
- Accuracy: ± 0,05 mm/± 0,002"
- Repeatability: 0,01 mm/0,0005"
- Maximum measurement speed: 1,5 m/s - 60 in/s

- Operating temperature: 0°C÷40°C
- Storage temperature: -10°C÷60°C
- Power: 1,5V SR44 (silver oxide cell) - 1 battery
- Battery life: 1 year continuous usage/
3 years under normal operation

Item	Measuring range
C.DIGIT.Z3	4÷40 mm

PRE SET LEADER

Preset LEADER are high precision instruments performing high technology operations. Their structure is guaranteed by best quality components along with an interface very simple and intuitive to use.

Designed and developed in the field of tooling manufacture, the **preset LEADER** are also essential in sharpening centers and production units of furniture or windows, for checking the condition of the tools and their settings before being mounted in the machine.

In recent years the family of the **preset LEADER** has increased thanks to additional models with new combinations of diameter and height, satisfying most of the needs of market operators.

Moreover, after checking by our technical department, presetter devices with special dimensions can also be constructed on request.



Item	Measuring range
PRE-SET LEADER 33	H 360 mm - Ø 320 mm
PRE-SET LEADER 35	H 500 mm - Ø 320 mm
PRE-SET LEADER 53	H 360 mm - Ø 520 mm
PRE-SET LEADER 55	H 500 mm - Ø 520 mm

TECHNICAL FEATURES:

- Structural components heat treated
- High resolution CMOS Camera
- Telecentric lenses
- Measurement field 7x7
- Optical zoom 40x
- Digital zoom 16x
- Recirculating ball bearing linear guides with preloaded slides
- Micrometric movements by control knob
- Interchangeable tooling holder
- Housed-in PC
- 17" TFT colour monitor
- Mouse
- 7 USB outputs
- 1 Ethernet-Lan output

Leader	Dimension	Weight	Power
33	B 1100 P 620 H 900 mm	115 kg	230 V (on request 110V)
35	B 1200 P 620 H 1040 mm	121 kg	
53	B 1200 P 620 H 900 mm	131 kg	
55	B 1200 P 620 H 1040 mm	137 kg	



Telecentric lenses



High resolution camera

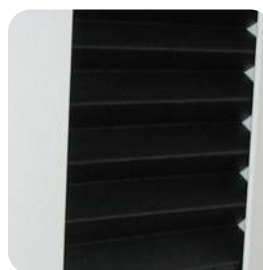

Protective bellows



Micrometric adjustment

SPARE CONE-HOLDERS

The **preset LEADER** are supplied with a cone-holder (ISO30, ISO40, ISO50, HSK63) on your choice. Other cone-holders can also be purchased later.

Item	Description
PRE-SET BL.ISO 30	for tool holders ISO 30
PRE-SET BL.ISO 40	for tool holders ISO 40
PRE-SET BL.ISO 50	for tool holders ISO 50
PRE-SET BL.HSK 63F	for tool holders HSK 63F/D/B
PRE-SET BL.HSK 63A	for tool holders HSK 63A/C/E
PRE-SET BL.HSK 80A	for tool holders HSK 80
PRE-SET BL.30x130	with arbor L=130, for tools with bore d= 30
PRE-SET BL.30x300	with arbor L=300, for tools with bore d= 30
PRE-SET BL.35x130	with arbor L=130, for tools with bore d= 35
PRE-SET BL.35x300	with arbor L=300, for tools with bore d= 35
PRE-SET BL.40x130	with arbor L=130, for tools with bore d= 40
PRE-SET BL.40x300	with arbor L=300, for tools with bore d= 40
PRE-SET BL.50x130	with arbor L=130, for tools with bore d= 50
PRE-SET BL.50x300	with arbor L=300, for tools with bore d= 50



Cone-holders for PRESET LEADER
Production before June 2012
Until serial no. Y12/L1177)

Cone-holders for
PRESET LEADER
(Production
after
June 2012
Starting from
serial no.
Y12/L1178)



Item
PRE-SET B. ISO 30
PRE-SET B. ISO 40
PRE-SET B. ISO 50
PRE-SET B. HSK 63 F

The software, CVS (Conti Vision System), was designed in-house and further developed in collaboration with the professionals and machine operators to ensure the completeness of the functions and best ease of use. It is Windows-based and can be updated via Internet connection.

CVS Software features:

- Tool diameter and height measuring performed:
 - with Fixed Axis: manual detection, by approaching the profile of the tool
 - with Mobile Axis: automatic detection, simply by rotating the tool

- Real view function
- Storing of 200 machine origins
- Storing of 20.000 tools
- Tool list creation
- Storing of tool profile
- Printing of tool profile
- Printing of labels
- Printing of screenshot
- Alphanumerical keyboard on screen
- Various geometrical functions:
 - Radius
 - Angle
 - Perpendicularity
 - Tangent
 - Goniometer function on screen
- Etc.
- Language selection
- Online software update
- Optional:
 - Touch screen
 - Tool file generation for sending data to CNC machines
 - Setting for Balluff sensor

Example of measurements taken using the Conti Vision System (CVS)

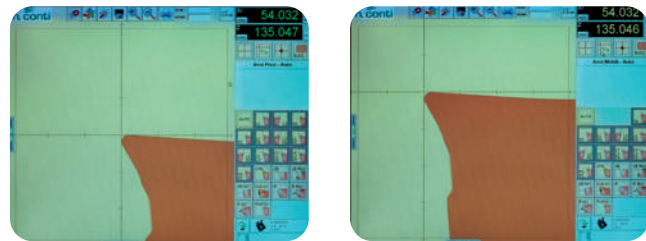

Measuring in "fixed axe" mode

Measuring in "movable axe" mode

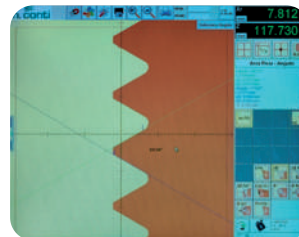

Angle measurement

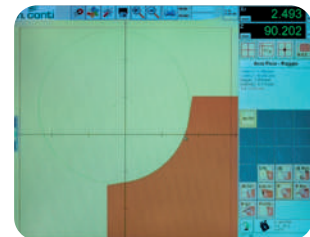

Radius measurement

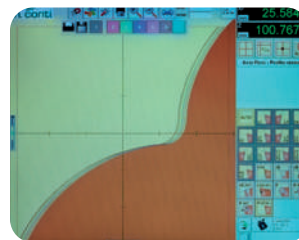

Comparing multiple shaped cutters

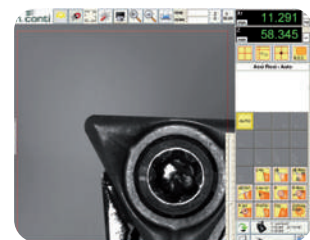

Real view

Optional



Holding cart

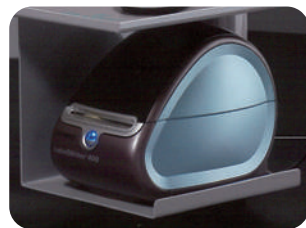

Label printer



A4 laser printer

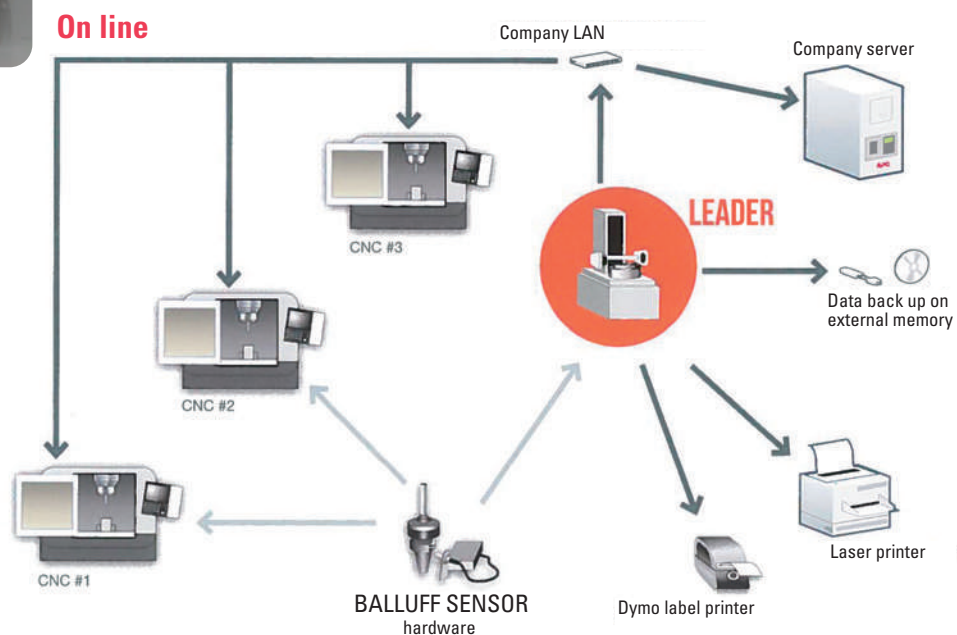



PRE SET P368LR

The **Preset P368LR** is a precision tool setting instrument, easy and quick to use, especially designed to meet the requirements of the NC machine operators. It is mainly used in the wood, metal and glass working field where there is a constant need to set or adjust the tools.

The **Preset P368LR** measures both the radius/diameter and the length/height of the tools. Working with different tool holders or various machines can be possible by setting up to 4 origins. The measures shown in the display can be set directly in the machine and the production quickly starts again.

Item	Measuring range
PRE-SET P368LR	H 300 mm - Ø 250 mm

- Excellent price/quality relationship
- Considerable cutback of tooling-up times, no waste of material
- 4 machine origins
- It measures shank tools and cutterheads
- Battery powered – no need of electrical plug
- Large display easy to read
- One touch conversion mm/inch
- Interchangeable cone holders (ISO, HSK, VDI, arbors)

TECHNICAL FEATURES:

Slide guides:

X axis: slide guide with preloaded recirculating ball bearings
Z axis: slide guide in anti-friction material

Measurement detection: Precision magnetic strip

Dimension	Resolution	Weight	Power
B 410 mm P 150 mm H 540 mm	0,01 mm	12 kg	2 AA Batteries each display (included)

TIGHTENING DEVICE

Upon request the preset P368LRB can be supplied with a special tightening device. This tightening equipment is suitable only for a first soft tighten of the tool, when adjusting the clamping length in the tool holder. Afterwards, the tool must be strongly tightened on a separate proper clamping device (see our items T139 at page 7.34). Any incorrect use of the P368LRB can invalidate the precision of the whole instrument.

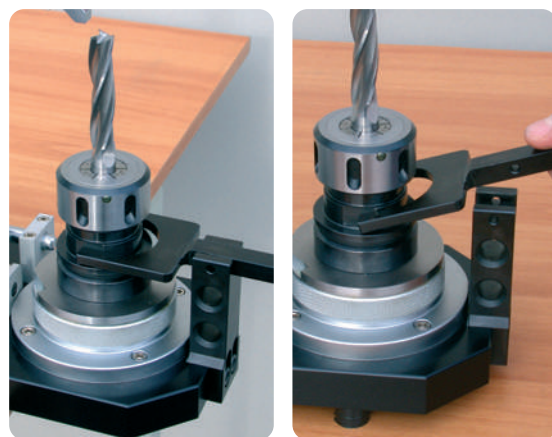

Item	Description
AS1500014	Support + Blocking fork flange=46
AS1500020	Support + Blocking fork flange=30
AS1500044	Support + Blocking fork flange=41
AS1500062	Support + Blocking fork flange=36
AS1500069	Support + Blocking fork flange=47

Item	Description
AS1500028	Blocking fork flange=36
AS1500029	Blocking fork flange=30
AS1500049	Blocking fork flange=41
AS1500050	Blocking fork flange=45
AS1500051	Blocking fork flange=47
AS1500052	Blocking fork flange=60

SPARE CONE-HOLDERS

Item	Description
PRE-SET B.ISO 30	for tool holders ISO 30
PRE-SET B.ISO 40	for tool holders ISO 40
PRE-SET B.ISO 50	for tool holders ISO 50
PRE-SET B.HSK 63F	for tool holders HSK 63F/D/B
PRE-SET B.HSK 63A	for tool holders HSK 63A/C/E
PRE-SET B.HSK 80A	for tool holders HSK 80
PRE-SET B.30x130	with arbor L=130, for tools with bore d= 30
PRE-SET B.30x300	with arbor L=300, for tools with bore d= 30
PRE-SET B.35x130	with arbor L=130, for tools with bore d= 35
PRE-SET B.35x300	with arbor L=300, for tools with bore d= 35
PRE-SET B.40x130	with arbor L=130, for tools with bore d= 40
PRE-SET B.40x300	with arbor L=300, for tools with bore d= 40
PRE-SET B.50x130	with arbor L=130, for tools with bore d= 50
PRE-SET B.50x300	with arbor L=300, for tools with bore d= 50

The preset P368LR are supplied with a cone-holder (ISO30, ISO40, ISO50) on your choice. Other cone-holders can also be purchased later.

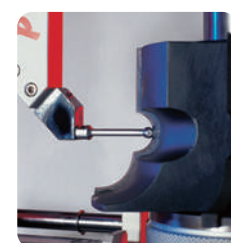

T.SFERA

Spherical feeler for shaped cutters (optional)

Item
T. SFERA-P368

PRE SET P368XL

The **Preset P368** is a precise instrument, easy and quick to use: these characteristics have been especially designed to meet the requirements of the NC machine operator. It is used in the wood, metal and glass machining industries where the tools must be pre-set or adjusted.

The **Preset P368XL**, can be used for both measuring lengths and radius of the tools.

The **Preset P368XL** is necessary when working with tools with diameter up to 400 mm.



Item	Measuring range
PRE-SET P368XL	H 300 mm - Ø 400 mm
<ul style="list-style-type: none"> - Excellent quality/price relationship - Considerable cutback of tooling-up times - It measures all types of tools - It does not require connection to the electrical mains - Display with large numbers - Interchangeable cone holders (ISO, HSK, VDI, arbors) 	

MEASURING CAPACITY:

Slide guides

Axis X: slide guide with ball recirculation

Axis Z: slide guide in anti-friction material

Measurement detection Magnetic strip

Dimension	Resolution	Weight	Power
B 410 mm P 150 mm H 540 mm	0,01 mm	12 kg	2 AA Batteries each display (included)

TIGHTENING DEVICE

Upon request the preset P368LRB can be supplied equipped with a special tightening device. This tightening equipment is suitable only for a first soft tighten of the tool, when adjusting the clamping length in the tool holder. Afterwards, the tool must be strongly tightened on a separate proper clamping device (see our items T139 at page 7.34). Any incorrect use of the P368LRB can invalidate the precision of the whole instrument.

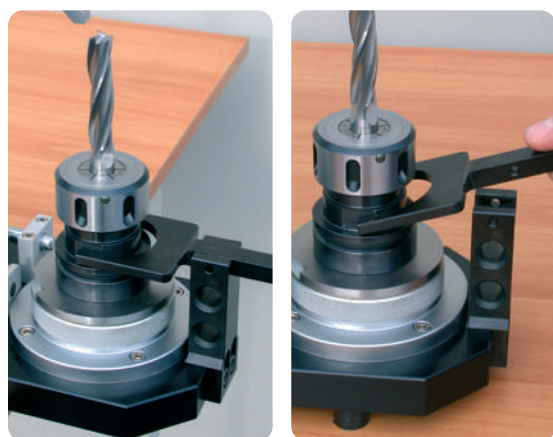

Item	Description
AS1500014	Support + Blocking fork flange=46
AS1500020	Support + Blocking fork flange=30
AS1500044	Support + Blocking fork flange=41
AS1500062	Support + Blocking fork flange=36
AS1500069	Support + Blocking fork flange=47

Item	Description
AS1500028	Blocking fork flange=36
AS1500029	Blocking fork flange=30
AS1500049	Blocking fork flange=41
AS1500050	Blocking fork flange=45
AS1500051	Blocking fork flange=47
AS1500052	Blocking fork flange=60

SPARE CONE-HOLDERS

Item	Description
PRE-SET B.ISO 30	for tool holders ISO 30
PRE-SET B.ISO 40	for tool holders ISO 40
PRE-SET B.ISO 50	for tool holders ISO 50
PRE-SET B.HSK 63F	for tool holders HSK 63F/D/B
PRE-SET B.HSK 63A	for tool holders HSK 63A/C/E
PRE-SET B.HSK 80A	for tool holders HSK 80
PRE-SET B.30x130	with arbor L=130, for tools with bore d= 30
PRE-SET B.30x300	with arbor L=300, for tools with bore d= 30
PRE-SET B.35x130	with arbor L=130, for tools with bore d= 35
PRE-SET B.35x300	with arbor L=300, for tools with bore d= 35
PRE-SET B.40x130	with arbor L=130, for tools with bore d= 40
PRE-SET B.40x300	with arbor L=300, for tools with bore d= 40
PRE-SET B.50x130	with arbor L=130, for tools with bore d= 50
PRE-SET B.50x300	with arbor L=300, for tools with bore d= 50

The preset **P368XL** are supplied with a cone-holder (ISO30, ISO40, ISO50) on your choice. Other cone-holders can also be purchased later.

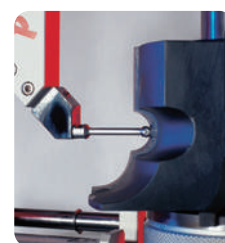

T.SFERA

Spherical feeler for shaped cutters (optional)

Item
T. SFERA-P368



PRE SET P388

The **Pre-set P388** is a precision instrument that measures the radius and height of a tool by means of a spring-loaded probe and an optical DIAL INDICATOR.

The DIAL INDICATOR has a double function:

- 1) The contact between the probe and the tool is not strong, therefore it is possible to measure also particularly fragile tools, such as diamond tools.
- 2) The exact measurement repeating is guaranteed by the DIAL INDICATOR that shows when the tool is in the correct measuring position.

The structure of the **Pre-set P388** is particularly sturdy thanks also to the Z axis column made of steel and the use of preloaded recirculating ball bearings guides..

Item	Measuring range
PRE-SET P388	H 300 mm - Ø 250 mm

- Excellent price/quality relationship
- Considerable cutback of tooling-up times, no waste of material
- 4 machine origins
- It measures shank tools and cutterheads
- Battery powered – no need of electrical plug
- Large display easy to read
- One touch conversion mm/inch
- Interchangeable cone holders (ISO, HSK, VDI, arbors)

TECHNICAL FEATURES:

Slide guides:

X axis: slide guide with preloaded recirculating ball bearings

Z axis: slide guide with preloaded recirculating ball bearings

Measurement detection: Precision magnetic strip

Dimension	Resolution	Weight	Power
B 420 mm P 180 mm H 690 mm	0,01 mm	29 kg	2 AA Batteries each display (included)

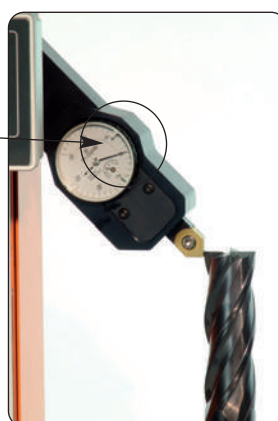

How to measure tool radius

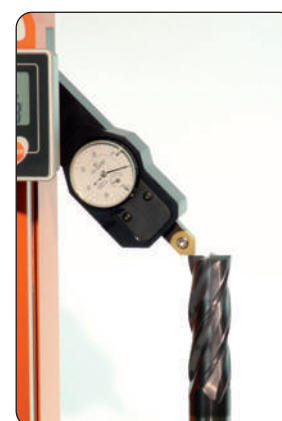

How to measure tool length

SPARE CONE-HOLDERS

Item	Description
PRE-SET B.ISO 30	for tool holders ISO 30
PRE-SET B.ISO 40	for tool holders ISO 40
PRE-SET B.ISO 50	for tool holders ISO 50
PRE-SET B.HSK 63F	for tool holders HSK 63F/D/B
PRE-SET B.HSK 63A	for tool holders HSK 63A/C/E
PRE-SET B.HSK 80A	for tool holders HSK 80
PRE-SET B.30x130	with arbor L=130, for tools with bore d= 30
PRE-SET B.30x300	with arbor L=300, for tools with bore d= 30
PRE-SET B.35x130	with arbor L=130, for tools with bore d= 35
PRE-SET B.35x300	with arbor L=300, for tools with bore d= 35
PRE-SET B.40x130	with arbor L=130, for tools with bore d= 40
PRE-SET B.40x300	with arbor L=300, for tools with bore d= 40
PRE-SET B.50x130	with arbor L=130, for tools with bore d= 50
PRE-SET B.50x300	with arbor L=300, for tools with bore d= 50

The presets **P388** are supplied with a cone-holder (ISO30, ISO40, ISO50) on your choice. Other cone-holders can also be purchased later.



PRE SET P382

The **Preset 382** is the result of two factors: technology and simplicity of use. Stiffness, precision, repeatability and reliability are the main characteristics of this instrument.

Item	Measuring range
PRE-SET P382	H 300 mm (optional 420 mm) - Ø 260 mm

Dimension	Resolution	Weight	power
B 450 mm P 300 mm H 770 mm	0,01 mm	60 kg	230 V (on request 110V)



TECHNICAL FEATURES:

Guides with preloaded recirculating ball bearings

Measurement transducers:

Optical scales

Electronics:

Alphanumeric keypad

Backlit display

Storing of 100 machine origins

Storing of 100 tools for each machine (total 10.000 tools)

Conversion mm-inches

Conversion radius-diameter

Absolute-incremental measurements

Hold function

Language selection (I-GB-D-F)

Power supply 230V - 50hz

2 serial outputs RS 232 C

Optional

Labels printing

Tools list printing

Origins list printing

Optional:

Labels printing

Tools list printing

Origins list printing



Detail of the step feeler

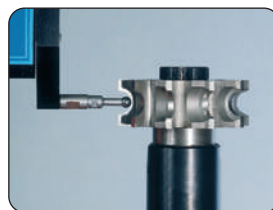

Item

T. SFERA-P382

Spherical feeler for shaped cutters (optional)



SPARE CONE-HOLDERS

Item	Description
PRE-SET B.ISO 30	for tool holders ISO 30
PRE-SET B.ISO 40	for tool holders ISO 40
PRE-SET B.ISO 50	for tool holders ISO 50
PRE-SET B.HSK 63F	for tool holders HSK 63F/D/B
PRE-SET B.HSK 63A	for tool holders HSK 63A/C/E
PRE-SET B.HSK 80A	for tool holders HSK 80
PRE-SET B.30x130	with arbor L=130, for tools with bore d= 30
PRE-SET B.30x300	with arbor L=300, for tools with bore d= 30
PRE-SET B.35x130	with arbor L=130, for tools with bore d= 35
PRE-SET B.35x300	with arbor L=300, for tools with bore d= 35
PRE-SET B.40x130	with arbor L=130, for tools with bore d= 40
PRE-SET B.40x300	with arbor L=300, for tools with bore d= 40
PRE-SET B.50x130	with arbor L=130, for tools with bore d= 50
PRE-SET B.50x300	with arbor L=300, for tools with bore d= 50

- The display has been designed to make any function simple and immediate. It is moreover provided with 2 RS232 C serial outputs and a software for labels printing.
- The cone-holder is made of hardened steel and is quickly interchangeable, always maintaining a perfect centring of the tool.

The preset P382 are supplied with a cone-holder (ISO30, ISO40, ISO50) on your choice.

Other cone-holders can also be purchased later.



ANGOLFAST

the right instruments for measuring angles

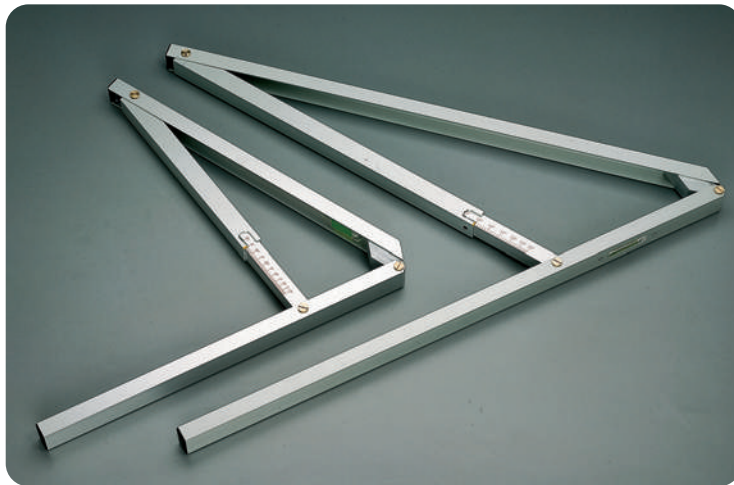

**PRECISE
STURDY
VERSATILE
LIGHT
HANDY
SIMPLE**

Item	Dimension
ANGOLFAST 45	450 mm
ANGOLFAST 70	700 mm
ANGOLFAST 70S	700 mm with reference shoulder

Angolfast is made of anodized aluminium, so it is very sturdy but at the same time light and easy to use. It features a shockproof spirit-level and can measure inner angles between 20-135°.

These in brief are the characteristics of this instrument, useful for:

**INTERIOR DECORATORS
KITCHEN UNIT MANUFACTURERS
FRAME INSTALLERS
BRICKLAYERS
CARPENTERS
SMITHS
SURVEYORS
ARCHITECTS**



Examples of use

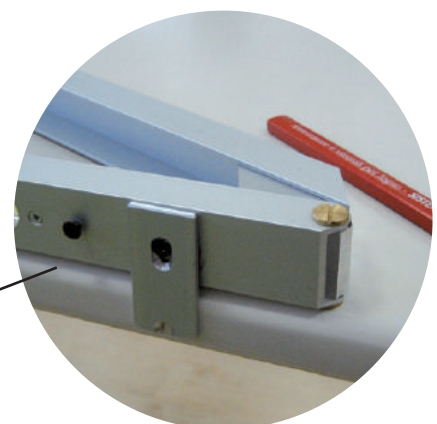
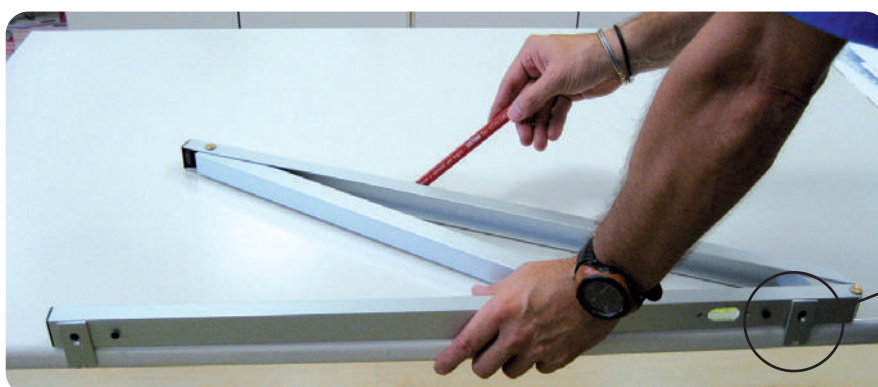

Angolfast 70S with reference shoulder for easier outlining.

GAUGES

Modern panel working production technologies have made indispensable the use of appropriate measuring instruments sufficiently precise to achieve high quality standards. The line of gauges shown below has been designed to meet all woodworking measurement needs and these gauges are commonly used even in the working of **aluminium, glass** and **sheet metals**. All the gauges are made of chromium-plate steel with inscribed scale and coloured black; **PRECISION** of 0,1 mm.

GAUGE FOR LINEAR MEASUREMENTS

ART. C.LIN



Suitable for measuring wood panel widths and lengths, but also for glass, aluminium profiles and sheet metal.

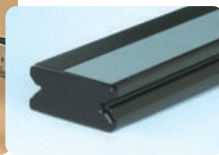

COMPLETELY NEW SHAPE

Item	Measuring range
C.LIN.0500	0÷500
C.LIN.0750	0÷750
C.LIN.1000	0÷1000
C.LIN.1500	0÷1500
C.LIN.2000	0÷2000
C.LIN.2500	0÷2500
C.LIN.3200	0÷3200

GAUGE FOR LINEAR MEASUREMENTS WITH STEEL PLATES

ART. C.LIN.PA

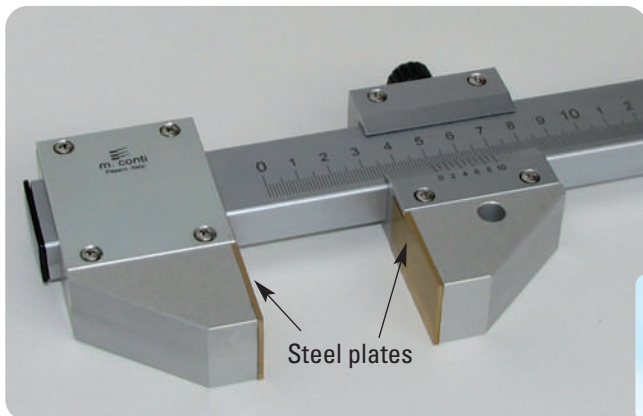

Suitable for measuring widths and lengths in glass, aluminium and sheet metal items.

Plates in TIN coated high resistance steel.

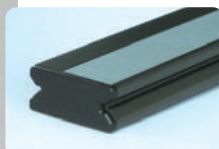

COMPLETELY NEW SHAPE

Item	Measuring range
C.LIN.PA0500	0÷500
C.LIN.PA0750	0÷750
C.LIN.PA1000	0÷1000
C.LIN.PA1500	0÷1500
C.LIN.PA2000	0÷2000
C.LIN.PA2500	0÷2500
C.LIN.PA3200	0÷3200

GAUGE FOR DISTANCE BETWEEN HOLES

ART. C.INT

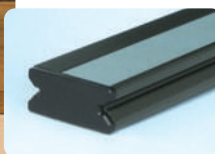
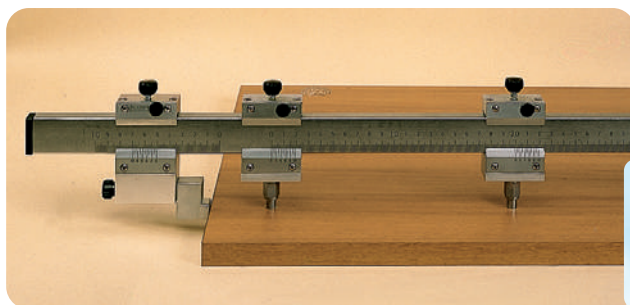

Practically indispensable for correctly measuring the distance from the edge of the panel to the centre of holes or the centre distance between one hole and another. Supplied with one semi-fixed slider and two moving sliders with dia. 8 pin.

COMPLETELY NEW SHAPE

Item	Measuring range
C.INT0500	0÷500
C.INT0750	0÷750
C.INT1000	0÷1000
C.INT1500	0÷1500
C.INT2000	0÷2000
C.INT2500	0÷2500
C.INT3200	0÷3200

Spare parts

C.CORS.PER	Spare slider complete with pin		
C.PER.0415	Conical pin for dia. 4 - dia. 15 holes		
C.PERNO.03	For hole Ø 3	C.PERNO.14	For hole Ø 14
C.PERNO.04	For hole Ø 4	C.PERNO.15	For hole Ø 15
C.PERNO.05	For hole Ø 5	C.PERNO.16	For hole Ø 16
C.PERNO.06	For hole Ø 6	C.PERNO.18	For hole Ø 18
C.PERNO.07	For hole Ø 7	C.PERNO.20	For hole Ø 20
C.PERNO.08	For hole Ø 8	C.PERNO.25	For hole Ø 25
C.PERNO.09	For hole Ø 9	C.PERNO.26	For hole Ø 26
C.PERNO.10	For hole Ø 10	C.PERNO.30	For hole Ø 30
C.PERNO.12	For hole Ø 12	C.PERNO.35	For hole Ø 35

GAUGE FOR 90° V-FOLD CUTS

ART. C.INV

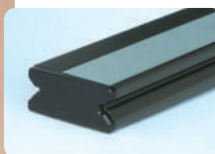
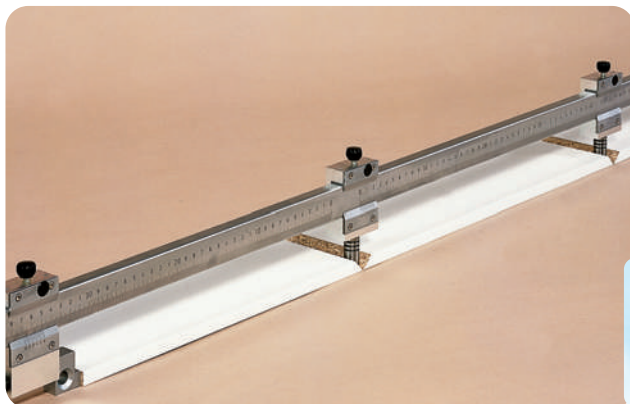

Suitable for the production of drawers, it features a semi-fixed slider and two moving sliders with V-90° pin.

COMPLETELY NEW SHAPE

Item	Measuring range
C.INV1000	550÷0÷1000
C.INV1500	550÷0÷1500
C.INV2000	550÷0÷2000
C.CORS.V90°	Spare slider complete with pin
C.PERS.V90°	V-90° pin

GAUGE FOR INSIDE/OUTSIDE MEASURING

ART. C.LIE

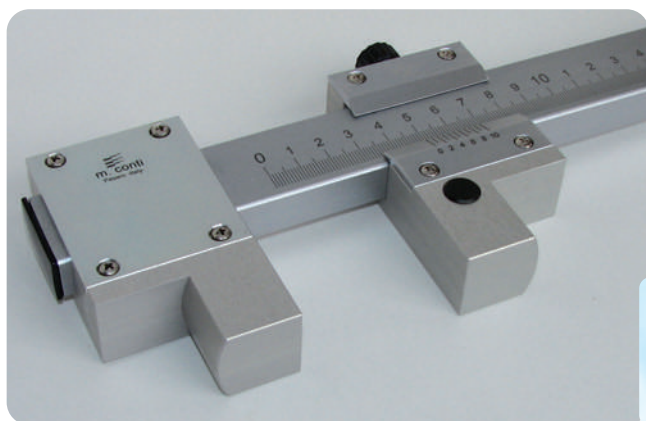

Suitable for measuring big dimension openings (min. 50 mm) on wood panels and frames. For inside measurements mm 50 is to be added.

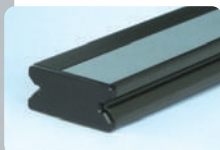

COMPLETELY NEW SHAPE

Item	Measuring range
C.LIE0500	0÷500
C.LIE0750	0÷750
C.LIE1000	0÷1000
C.LIE1500	0÷1500
C.LIE2000	0÷2000
C.LIE2500	0÷2500
C.LIE3200	0÷3200

GAUGE FOR INSIDE/OUTSIDE MEASURING WITH STEEL PLATES

ART. C.LIE.PA

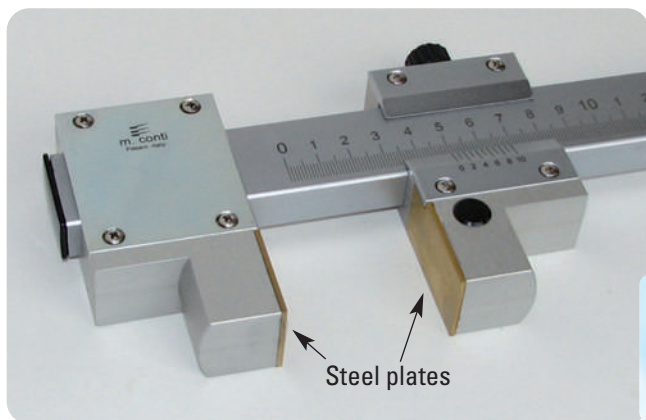

Suitable for measuring big dimension openings (min. 50 mm) on glass, alu, metal and PVC items.

Plates in TIN coated high resistance steel.



COMPLETELY NEW SHAPE

Item	Measuring range
C.LIE.PA0500	0÷500
C.LIE.PA0750	0÷750
C.LIE.PA1000	0÷1000
C.LIE.PA1500	0÷1500
C.LIE.PA2000	0÷2000
C.LIE.PA2500	0÷2500
C.LIE.PA3200	0÷3200

GAUGE FOR LINEAR MEASUREMENTS AND DISTANCE BETWEEN CENTRES

ART. C.LIN.PI

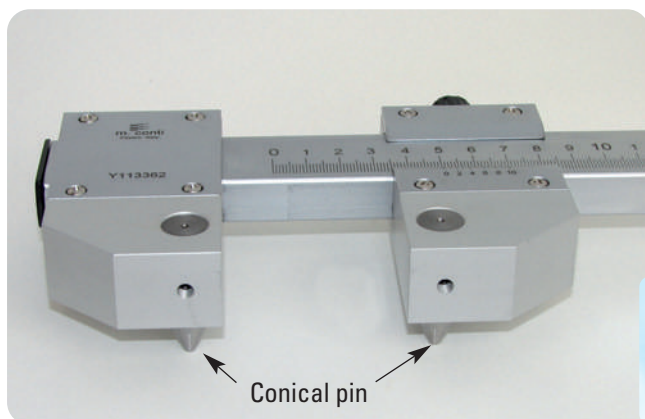

The length is read directly on the graduated scale, the hole distance is obtained by adding 20 mm to the value read on the scale.
Two tapered pins are supplied as standard $\varnothing 4/\varnothing 15$ mm.

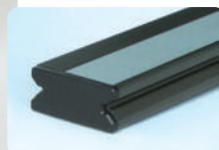

COMPLETELY NEW SHAPE

Item	Measuring range
C.LIN.PI0500	0÷500
C.LIN.PI0750	0÷750
C.LIN.PI1000	0÷1000
C.LIN.PI1500	0÷1500
C.LIN.PI2000	0÷2000
C.LIN.PI2500	0÷2500
C.LIN.PI3200	0÷3200
C.PER.1415	Conical pin for dia. 4 - dia. 15 holes

GAUGE FOR LINEAR MEASUREMENTS, DISTANCE FROM THE CENTRES OF THE HOLE TO THE EDGE OF THE PANEL

ART. C.LIN.PB

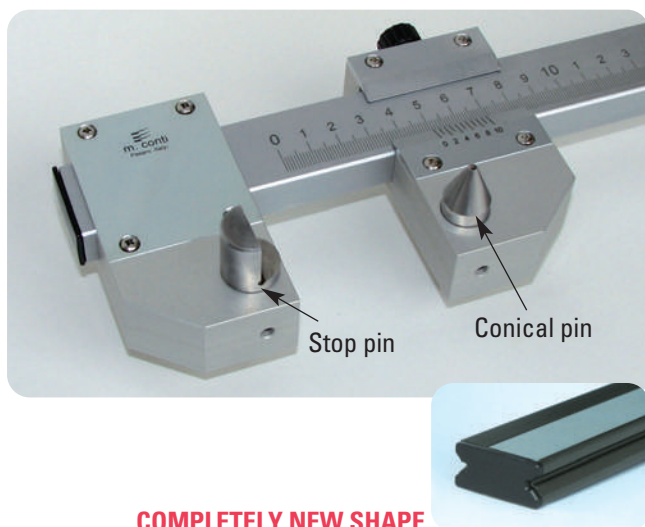

The length is read directly on the graduated scale, the hole distance is obtained by adding 20 mm to the value read on the scale. Two pins are supplied as standard (one tapered of $\varnothing 4/\varnothing 15$ mm and one as stop).
With the left pin the distance between the edge of the panel and the centre of the hole can be measured.

Measuring of the distance of panel edge to the hole centres

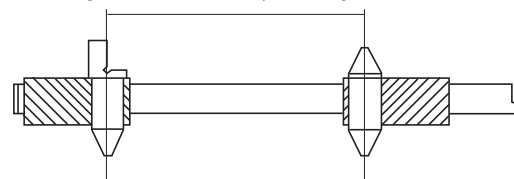

Measuring of distance between hole centres

COMPLETELY NEW SHAPE

Item	Measuring range
C.LIN.PB0500	0÷500
C.LIN.PB0750	0÷750
C.LIN.PB1000	0÷1000
C.LIN.PB1500	0÷1500
C.LIN.PB2000	0÷2000
C.LIN.PB2500	0÷2500
C.LIN.PB3200	0÷3200
C.PER.1415	Conical pin for dia. 4 - dia. 15 holes
C.PER.B12	Stop pin



GAUGE FOR LINEAR MEASUREMENTS, WITH LONG JAWS

ART. C.LIN.L

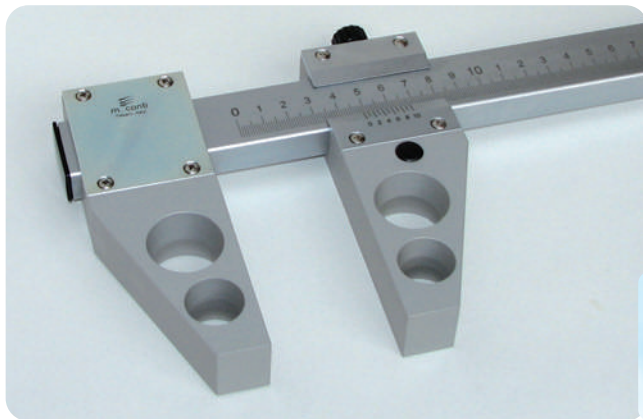

Suitable for measuring width and length of wood panel
JAW LENGTH 97 mm.

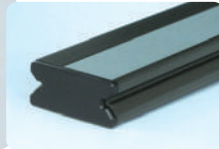

COMPLETELY NEW SHAPE

Item	Measuring range
C.LIN.L0500	0÷500
C.LIN.L0750	0÷750
C.LIN.L1000	0÷1000
C.LIN.L1500	0÷1500
C.LIN.L2000	0÷2000
C.LIN.L2500	0÷2500
C.LIN.L3200	0÷3200

GAUGE FOR LINEAR MEASUREMENTS, WITH LONG JAWS AND STEEL PLATES

ART. C.LIN.L.PA

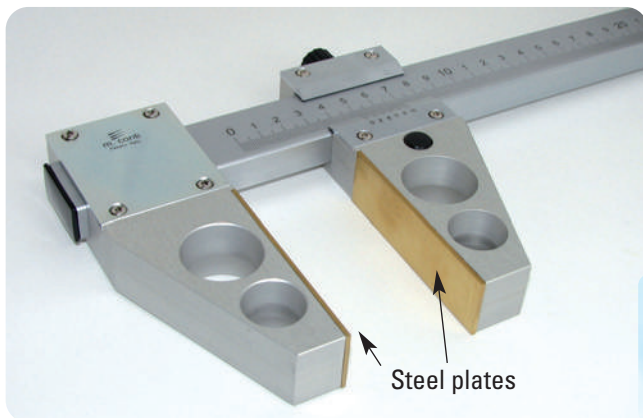

Suitable for measuring the width and length of glass and aluminium items and when cutting sheet metal.
JAW LENGTH 97 mm.

Plates in TIN coated high resistance steel.

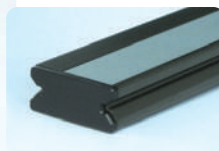

COMPLETELY NEW SHAPE

Item	Measuring range
C.LIN.L.PA0500	0÷500
C.LIN.L.PA0750	0÷750
C.LIN.L.PA1000	0÷1000
C.LIN.L.PA1500	0÷1500
C.LIN.L.PA2000	0÷2000
C.LIN.L.PA2500	0÷2500
C.LIN.L.PA3200	0÷3200

GAUGE FOR 45° CUTS

ART. C.L45

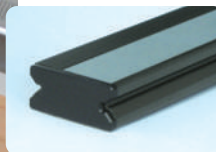

Suitable for the production of frames, sashes and other components with 45° angles.
Minimum measurable length - 80mm.

COMPLETELY NEW SHAPE

Item	Measuring range
C.L45.0500	80÷500
C.L45.0750	80÷750
C.L45.1000	80÷1000
C.L45.1500	80÷1500
C.L45.2000	80÷2000
C.L45.2500	80÷2500
C.L45.3200	80÷3200

GAUGE FOR DIAGONAL AND OUT OF SQUARE MEASUREMENTS

ART. C.LIN.D

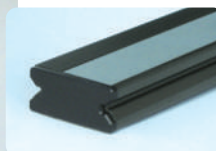
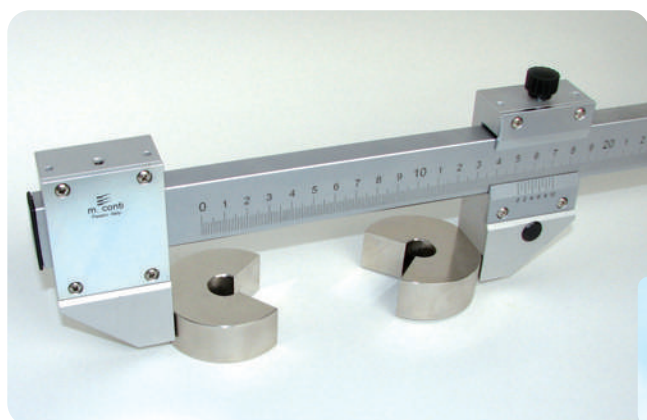

Suitable for measuring the out of square of a panel or any diagonal line



2 reference steel discs included

COMPLETELY NEW SHAPE

Item	Measuring range
C.LIN.D.0500	0÷500
C.LIN.D.0750	0÷750
C.LIN.D.1000	0÷1000
C.LIN.D.1500	0÷1500
C.LIN.D.2000	0÷2000
C.LIN.D.2500	0÷2500
C.LIN.D.3200	0÷3200

Spare parts

C.DIS.040	D=40 - 90° cut - Reference steel disc
-----------	---------------------------------------

OPTICAL LENS

ART. C.LETTORE

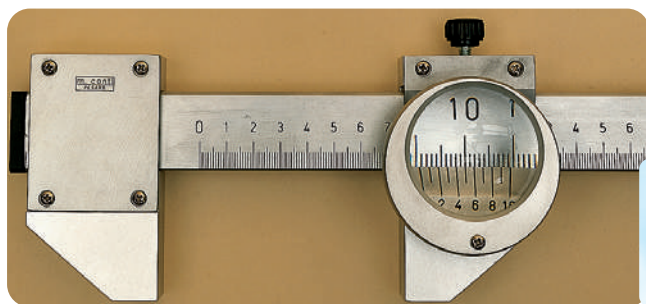

Used to improve the evaluation of the scale in case of reading from a distance. Made of anodized aluminium dia. 50 mm, it can be used with any gauge.



COMPLETELY NEW SHAPE

IYEM

C.LETTORE

Dimension

Ø 50

GAUGE CASE

ART. AST.CAL



Very useful for protecting the gauge when this is not in use or for transport. Made of wood.

Item

AST.CAL.

Dimension

800X150

TEST REPORTER

ART. CERT.

On request, all gauges can be supplied with our test report which certifies the accuracy every 100 mm. The gauges are tested using certified gauge blocks.

Item	Gauge measuring range
CERT.0500	500
CERT.0750	750
CERT.1000	1000
CERT.1500	1500
CERT.2000	2000
CERT.2500	2500
CERT.3200	3200

GAUGES DIGIT +

The Digit + digital gauges have been designed and developed to meet the need to take as quickly as possible the measurements of the dimensions of the panels in the production units.

Thanks to digital technology and to the large and easy to use display, the subjectivity of the operator is bypassed and the maximum precision is ensured.

All Digit + can be supplied on request with centesimal resolution (0.01 mm) and / or serial output.

GAUGES FOR LINEAR MEASUREMENTS

ART. DIGIT950

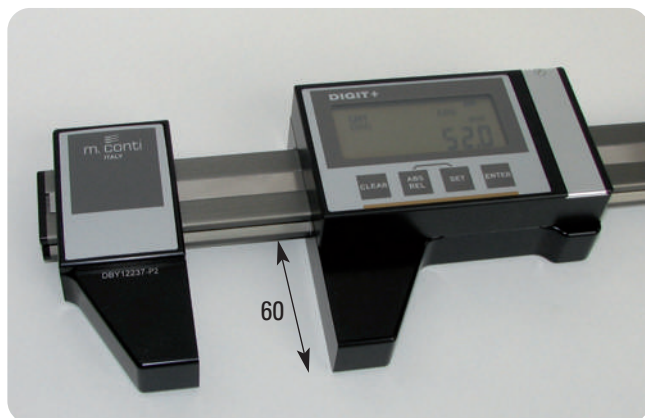

- Resolution 0,1 mm
- Light, precise and easy to use
- Battery powered (1 battery 1,5 V type AA)
- Measuring system by magnetic strip our production
- Display functions:
 - absolute/relative
 - selection of measuring mode
 - programmable automatic shutdown
 - mm/inches conversion
 - large display for easy reading
- Bars and jaws are made of anodized aluminium with 500 HV hardness on the surface

Item	Measuring range
DIGIT950.0500	0÷500
DIGIT950.0750	0÷750
DIGIT950.1000	0÷1000
DIGIT950.1500	0÷1500
DIGIT950.2000	0÷2000
DIGIT950.2500	0÷2500
DIGIT950.3100	0÷3100

GAUGES FOR LINEAR-INSIDE/OUTSIDE MEASUREMENTS

ART. DIGIT955

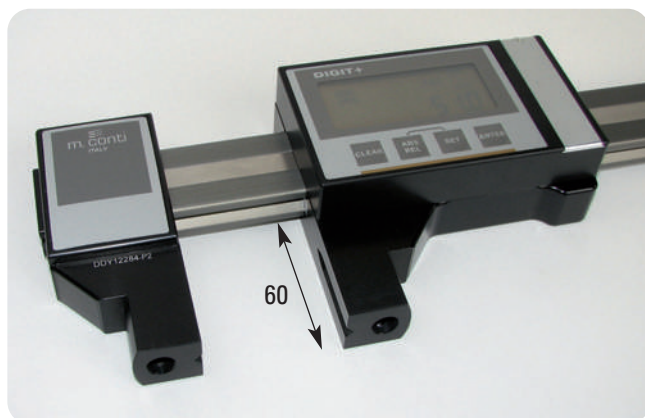

- Resolution 0,1 mm
- Light, precise and easy to use
- Battery powered (1 battery 1,5 V type AA)
- Measuring system by magnetic strip our production
- Display functions:
 - absolute/relative
 - selection of measuring mode
 - programmable automatic shutdown
 - mm/inches conversion
 - large display for easy reading
- Bars and jaws are made of anodized aluminium with 500 HV hardness on the surface

- Optional: pins + reference jig for measuring distances between holes

Item	Measuring range
DIGIT955.0500	0÷500
DIGIT955.0750	0÷750
DIGIT955.1000	0÷1000
DIGIT955.1500	0÷1500
DIGIT955.2000	0÷2000
DIGIT955.2500	0÷2500
DIGIT955.3100	0÷3100

GAUGE FOR LINEAR, INSIDE/OUTSIDE, DISTANCE BETWEEN HOLES, OUT OF SQUARE ANGLES MEASUREMENTS

ART. DIGIT990



- Resolution 0,1 mm
- Light, precise and easy to use
- Battery powered (1 battery 1,5 V type AA)
- Measuring system by magnetic strip our production
- Display functions:
 - absolute/relative
 - selection of measuring mode
 - programmable automatic shutdown
 - mm/inches conversion
 - large display for easy reading
- Bars and jaws are made of anodized aluminium with 500 HV hardness on the surface

Item	Measuring range
DIGIT990.0500	0÷500
DIGIT990.0750	0÷750
DIGIT990.1000	0÷1000
DIGIT990.1500	0÷1500
DIGIT990.2000	0÷2000
DIGIT990.2500	0÷2500
DIGIT990.3100	0÷3100

GAUGE FOR 45° CUTS

ART. DIGIT991

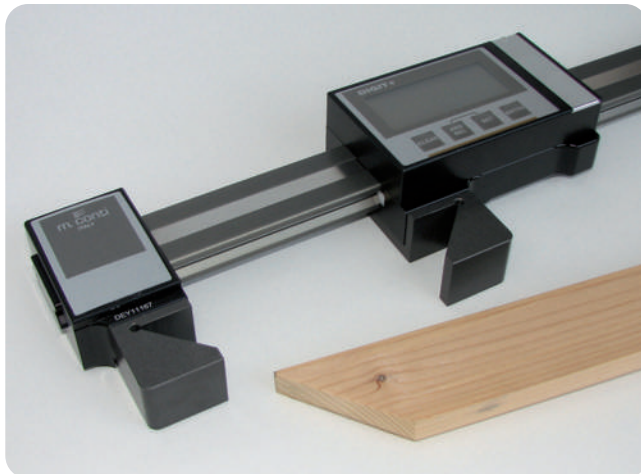

- Resolution 0,1 mm
- Light, precise and easy to use
- Battery powered (1 battery 1,5 V type AA)
- Measuring system by magnetic strip our production
- Display functions:
 - absolute/relative
 - selection of measuring mode
 - programmable automatic shutdown
 - mm/inches conversion
 - large display for easy reading
- Bars and jaws are made of anodized aluminium with 500 HV hardness on the surface

Suitable for the production of frames, sashes and other components with 45° angles.
Minimum measurable length - 80mm.

Item	Measuring range
DIGIT991.0750 NEW	0÷750
DIGIT991.1000 NEW	0÷1000
DIGIT991.1500 NEW	0÷1500
DIGIT991.2000 NEW	0÷2000
DIGIT991.2500 NEW	0÷2500
DIGIT991.3100 NEW	0÷3100

**GAUGE FOR LINEAR, INSIDE/OUTSIDE, DISTANCE BETWEEN HOLES, OUT OF SQUARE ANGLES MEASUREMENTS
DIGIT992**



- Resolution 0,1 mm
- Light, precise and easy to use
- Battery powered (1 battery 1,5 V type AA)
- Measuring system by magnetic strip our production
- Display functions:
 - absolute/relative
 - selection of measuring mode
 - programmable automatic shutdown
 - mm/inches conversion
 - large display for easy reading



2 reference steel discs included

Item	Measuring range
DIGIT992.1000	0÷1000
DIGIT992.1500	0÷1500
DIGIT992.2000	0÷2000
DIGIT992.2500	0÷2500
DIGIT992.3100	0÷3100

Spare parts

C.DIS.040	D=40 - 90° cut - Reference steel disc
-----------	---------------------------------------



GAUGE FOR LINEAR MEASUREMENTS, LONG JAWS

ART. DIGIT980/985/986/987

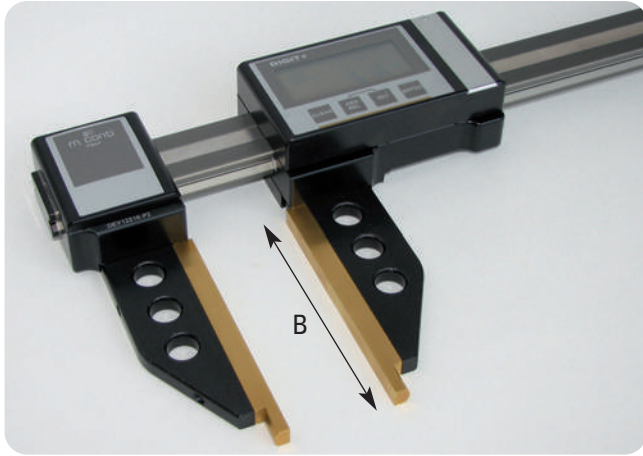

- Light-weight but at the same time rigid and accurate
- Battery-powered (nr. 1 Battery 1,5 type AA)
- Measuring system by magnetic strip our production
- Main display features: absolute/relative measuring, selection of measuring mode, programmable automatic shutdown, mm/inch conversion, large numbers display for easy reading.

- **STEEL PLATES**
- **JAWS WITH LIGHTENING HOLES**

Item	Measuring range	B
DIGIT980.1000 NEW	0÷1000	100
DIGIT980.1500 NEW	0÷1500	100
DIGIT980.2000 NEW	0÷2000	100
DIGIT980.2500 NEW	0÷2500	100
DIGIT980.3100 NEW	0÷3100	100
DIGIT985.1000 NEW	0÷1000	150
DIGIT985.1500 NEW	0÷1500	150
DIGIT985.2000 NEW	0÷2000	150
DIGIT985.2500 NEW	0÷2500	150
DIGIT985.3100 NEW	0÷3100	150

Item	Measuring range	B
DIGIT986.1000 NEW	0÷1000	200
DIGIT986.1500 NEW	0÷1500	200
DIGIT986.2000 NEW	0÷2000	200
DIGIT986.2500 NEW	0÷2500	200
DIGIT986.3100 NEW	0÷3100	200
DIGIT987.1000 NEW	0÷1000	300
DIGIT987.1500 NEW	0÷1500	300
DIGIT987.2000 NEW	0÷2000	300
DIGIT987.2500 NEW	0÷2500	300
DIGIT987.3100 NEW	0÷3100	300

GAUGE WITH NONIUS FOR LINEAR-INSIDE/OUTSIDE MEASUREMENTS, STEEL JAWS

ART. DIGIT900N

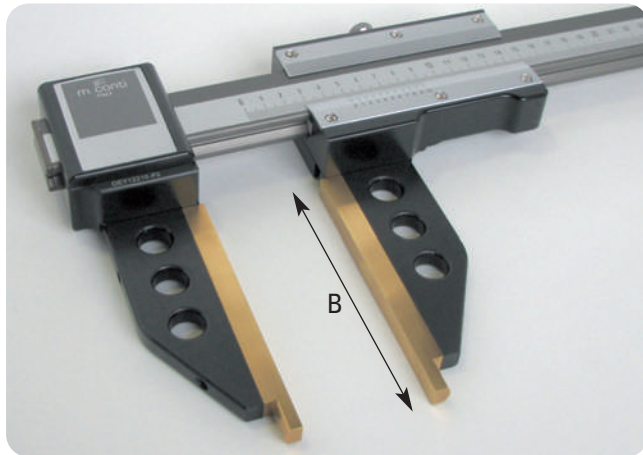

- 0,05 mm Resolution
- Light, precise and easy to use

- **STEEL PLATES**
- **JAWS WITH LIGHTENING HOLES**

Item	Measuring range	B
C.LIE.L.PA.1000.100 NEW	0÷1000	100
C.LIE.L.PA.1500.100 NEW	0÷1500	100
C.LIE.L.PA.2000.100 NEW	0÷2000	100
C.LIE.L.PA.2500.100 NEW	0÷2500	100
C.LIE.L.PA.3100.100 NEW	0÷3100	100
C.LIE.L.PA.1000.150 NEW	0÷1000	150
C.LIE.L.PA.1500.150 NEW	0÷1500	150
C.LIE.L.PA.2000.150 NEW	0÷2000	150
C.LIE.L.PA.2500.150 NEW	0÷2500	150
C.LIE.L.PA.3100.150 NEW	0÷3100	150

Item	Measuring range	B
C.LIE.L.PA.1000.200 NEW	0÷1000	200
C.LIE.L.PA.1500.200 NEW	0÷1500	200
C.LIE.L.PA.2000.200 NEW	0÷2000	200
C.LIE.L.PA.2500.200 NEW	0÷2500	200
C.LIE.L.PA.3100.200 NEW	0÷3100	200
C.LIE.L.PA.1000.300 NEW	0÷1000	300
C.LIE.L.PA.1500.300 NEW	0÷1500	300
C.LIE.L.PA.2000.300 NEW	0÷2000	300
C.LIE.L.PA.2500.300 NEW	0÷2500	300
C.LIE.L.PA.3100.300 NEW	0÷3100	300

GAUGE WITH WIRELESS CONNECTION FOR LINEAR MEASUREMENTS

ART. DIGIT950



The DIGIT+ RF have a sender integrated in the caliper and a separate Master for receiving the data appearing on the display of the digital caliper and sent via radio frequency.

The Receiver must be connected to a Computer or any device able to process an ASCII string via RS232. In open space the transmission distance is approx. 50 meters.

Item	Measuring range
DIGIT950.1000RF	0÷1000
DIGIT950.1500RF	0÷1500
DIGIT950.2000RF	0÷2000
DIGIT950.2500RF	0÷2500
DIGIT950.3100RF	0÷3100

GAUGE WITH WIRELESS CONNECTION FOR LINEAR, INSIDE/OUTSIDE, DISTANCE BETWEEN HOLES, OUT OF SQUARE ANGLES MEASUREMENTS

ART. DIGIT990



The DIGIT+ RF have a sender integrated in the caliper and a separate Master for receiving the data appearing on the display of the digital caliper and sent via radio frequency.

The Receiver must be connected to a Computer or any device able to process an ASCII string via RS232. In open space the transmission distance is approx. 50 meters.

Item	Measuring range
DIGIT990.1000RF	0÷1000
DIGIT990.1500RF	0÷1500
DIGIT990.2000RF	0÷2000
DIGIT990.2500RF	0÷2500
DIGIT990.3100RF	0÷3100



MAGNETIC STRIP MEASURING SYSTEM

A fast and accurate system which allows reading of measurements directly on the M10 display. It is extremely easy to apply – just fix the magnetic strip on a suitable surface of the machine with double-sided adhesive tape and fit the display with the sensor on the movable part. When movement is made, the display indicates the position with respect to a machine reference. The measuring system can be used on PANEL SIZING MACHINES, ROLLER BEDS FOR MITRE SAWS, BORING MACHINES, CIRCULAR SAWS etc.



Item	Dimension
K.M.1000	Magnetic strip length 1000 mm
K.M.1500	Magnetic strip length 1500 mm
K.M.2000	Magnetic strip length 2000 mm
K.M.3000	Magnetic strip length 3000 mm
K.M.4500	Magnetic strip length 4500 mm

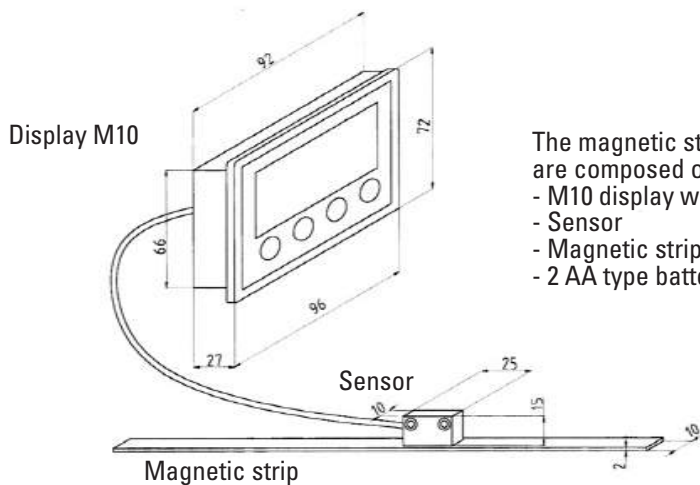

The magnetic strip measuring system is supplied in kits, they are composed of:

- M10 display with 0.5 m cable
- Sensor
- Magnetic strip (with double-sided tape)
- 2 AA type batteries



Application on panel sizing machines for squaring cuts

MAIN CHARACTERISTICS

- M10 display dimensions: 96x72x27 mm
- battery-powered with 1.5V AA type battery with a 12-month life
- system accuracy: 0.1 mm
- 5 incremental counting
- 5 programmable offsets
- programmable zero point
- battery check
- self diagnostic in real-time
- wide installation tolerances
- parameters stored in permanent memory
- battery voltage control shown on the display
- multifunction LCD display
- 4-key display keypad
- operating temperature: 5° - 60°C
- storage temperature: -20° - 70°C
- max. humidity: 95% (condensation not permitted)
- magnetic strip: 10x2 mm
- type of magnetic strip: MT500
- distance between magnetic strip and sensor: max. 2.5 mm

ELECTRONIC WORK STATION

For modern panel production for the furniture industry, adequate quality control is indispensable. During the production, to set up the manufacturing machines, at the end of the work shift for quality control, on acceptance of semi-finished products from third parties and for product certification, the electronic work station ensures the quality of your products and cuts machine stops and the time taken for assembly, thereby increasing productivity.



Item	Description
BCE 22 Y07-R	dimension 2.200 mm x 700 mm - panels/BCE 40 mm - thickness 0,1 mm with 6-position revolver
BCE 25 Y10-R	dimension 2.500 mm x 1.000 mm - panels/BCE 40 mm - thickness 0,1 mm with 6-position revolver
BCE 31 Y10-R	dimension 3.100 mm x 1.000 mm - panels/BCE 40 mm - thickness 0,1 mm with 6-position revolver



Execution with 6-position revolver to speed up feeler pin change

THANKS TO THIS WORK STATION YOU CAN CHECK

- Panel dimensions
- Out of square angles
- Distances between hole centres
- Parallelism and orthogonality between holes
- Depth of vertical and horizontal holes
- Dimension of grooves on panels
- Profiles on shaped panels
- Possibility of zero-setting to left and right



Blocking system by means of 2 vacuum units
Useful when small panels are measured (optional)

The electronic workstation is a real "quality control station" able to check almost all dimensions on the length, width and thickness of the panel. **The tolerance of max. 0,1mm** mistake on the whole device surface is guaranteed. **First quality components** as well as highly automated processing cycle ensure the extreme precision of the workstation. Last production step consists in the complete and **scrupulous inspection effected** also using certified block gauges. The electronic workstation can also operate in dusty environment.

SOFTWARE (optional)

For a rational use of the electronic workstation , a special software program has been developed to suit the requirements of modern furniture production and semi-finished products.

Completely worked out at **M.Conti** in collaboration with expert computer engineers and advise from important manufacturing companies, the software has been developed considering and trying to solve all producers' requirements.

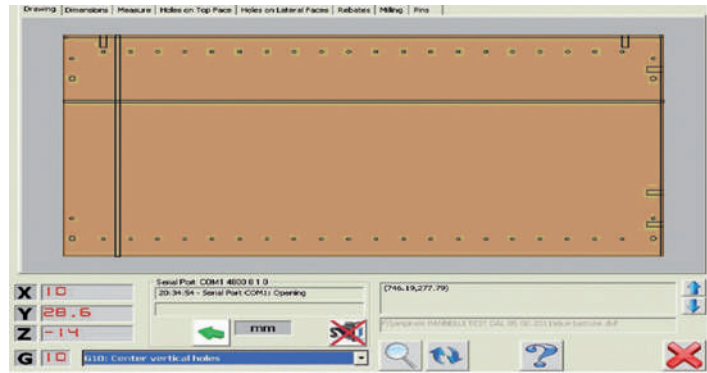
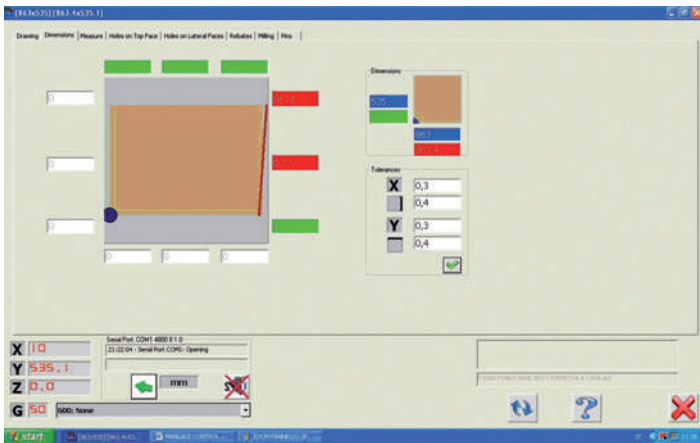

SOFTWARE SPECIFICATION

1) To **check and compare** a finished piece, or a CAD execution of the piece.

The elements which can be measured are:

1. Panel squaring
2. Vertical holes
3. Horizontal holes
4. Cuts
5. Relative distances

Using the software program we can visualize the measuring taken on the display and compare them with those requested thus detecting any mistake in production or out of tolerance dimension

A final report showing the measures taken can be printed, stored or attached to the production batch.

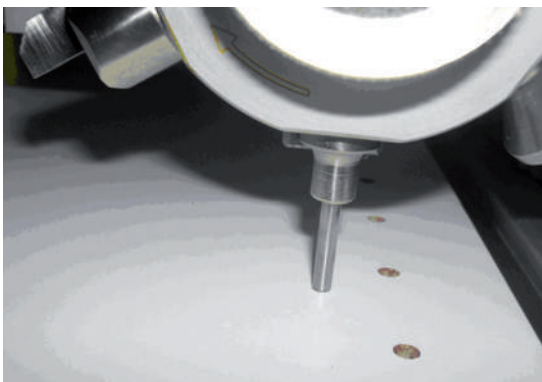
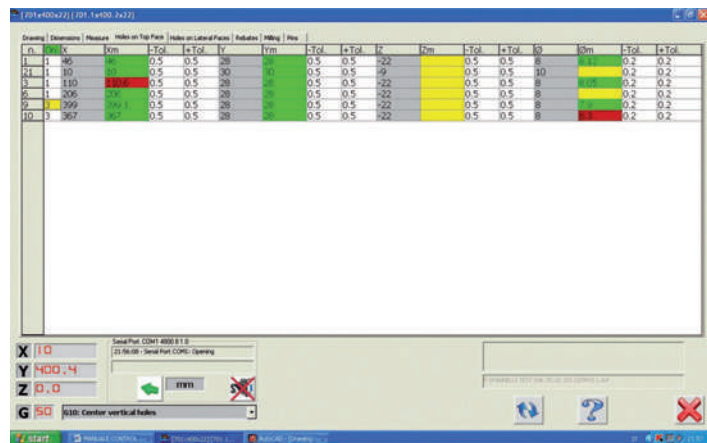

2) Graphic mode:

To **digitise a sample piece** and create a DXF file.

The elements which can be digitised are:

1. Curves



Side stop, longer execution (optional)



OPTIONAL FEATURES

Item	Description
AS1500201	software program
SPP040077	Z-axis
SPP040079	panel hold down system
SPP040107	additional vacuum unit
SPP040080	6 adapters revolver
AS1500224	higher side stop

Special devices



16



• "ARKADE+ZINKEL+ELLIX"
• Page 16.03 ÷ 16.05



• TRIMATIC FOR HINGES
• Page 16.06 - 16.07



• TRIMATIC 32
• Page 16.08



• DRILLING FOR CREMONE BOLTS
• Page 16.09



• SPECIAL DEVICES FOR ANGULAR
• HINGES INSERTING
• Page 16.10 - 16.11



• DRILLING JIG FOR MAKING HOLES
• FOR HINGE INSERTING
• Page 16.12 - 16.13



• DRILLING OF WOOD AND PVC
• WINDOW FRAME TO
• FIT CREMONE BOLT
• Page 16.13



• DRILLING JIG FOR MAKING HOLES
• FOR HINGE INSERTING - 32/90°
• Page 16.14



• ELECTRIC ROUTER
• Page 16.15



• ECCENTRIC CLAMP
• Page 16.16



• ROUTER TABLE
• Page 16.16



• DRIVER FOR CURVES
• Page 16.16

Klein®





LIFTING CLAMP
Page 16.16



EDGE CLAMP
Page 16.17



T-JOINTS CLAMP
Page 16.17



CARPENTER'S CLAMP
Page 16.17



DOOR LIFTER
Page 16.17



HORIZONTAL TYPE WITH
HORIZONTAL CLAMPING
Page 16.18



HORIZONTAL TYPE WITH
VERTICAL CLAMPING
Page 16.18



PNEUMATIC TYPE
Page 16.18



PUSHER TYPE
Page 16.18



KLEIN WASHER
Pag. 16.19



KLEIN CLEANER
Pag. 16.19

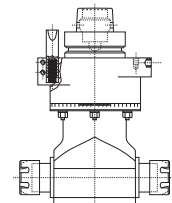

ANGLE HEADS FOR
CNC ROUTERS MACHINES
Pag. 16.20 - 16.21

“ARKADE+ZINKEL+ELLIX” - The complete routing system for arches

The building techniques of the ancient Greeks and Egyptians had not contemplated the joining of wall openings by the use of arches. Roman times brought great technological progress. Thanks to archlinking they were able to create wider openings and so this technique became increasingly popular. The greatest development and the most gracious examples of arch construction came during the middle ages and continued through the years until more modern times when other building methods largely replaced the use of arches. Modern day building construction has rediscovered the charm, aesthetic taste and practical aspects of archlinking and because of this our technical department has developed and patented **“ARKADE + ZINKEL”**. This is the only equipment on the market today capable of drawing and producing wooden, double-radius arch frames with practically no size restriction, quickly and with unmatched quality results.

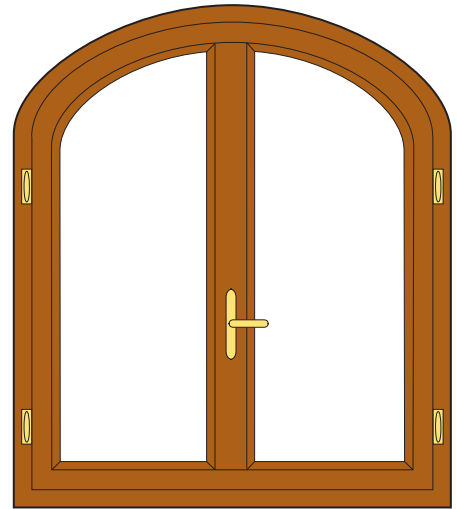

PATENT nr. AN93A000054



Item
ARKADE
“ARKADE” complete with tracer unit and goniometer

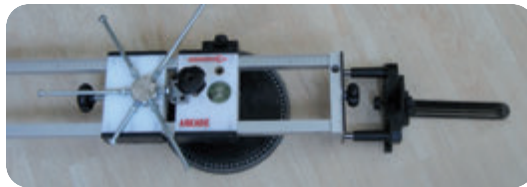

Item
ZINKEL
“ZINKEL” articulate accessory for double-radii arches



Item
ELLIX
“ELLIX” the equipment for perfect geometrical ellipse for customers already using “ARKADE”

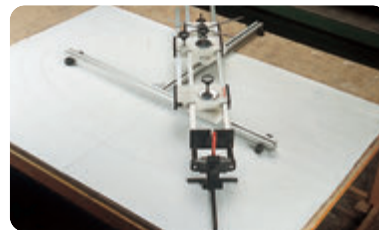

Item
ELLISYSTEM
“ELLISYSTEM” is the “last born” of our special equipments for producing arch frames. With “ELLISYSTEM” the customer can execute a perfect geometrical ellipse. Suitable for house restoration where the double radius arch is difficult to fit. Simple and easy to use, it keeps the same work procedure and features as “ARKADE” + “ELLIX”

Examples of windows made with “Arkade+Zinkel+Ellix”



WORK PROCEDURE

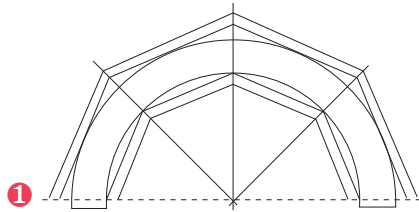

- 1 - Drawing of arch.
- Drawing and cutting of arch component parts.

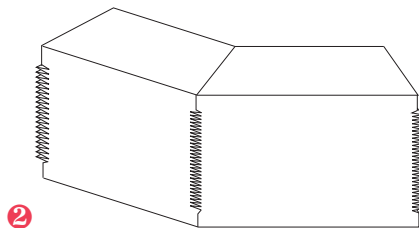

- 2 **Joining the arch component parts**
(use eccentric clamp Art. SPP060029).

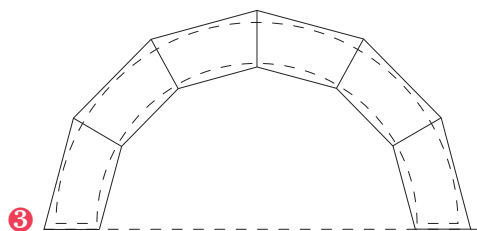

- 3 **Positioning and securing the arch component parts, which are glued together**

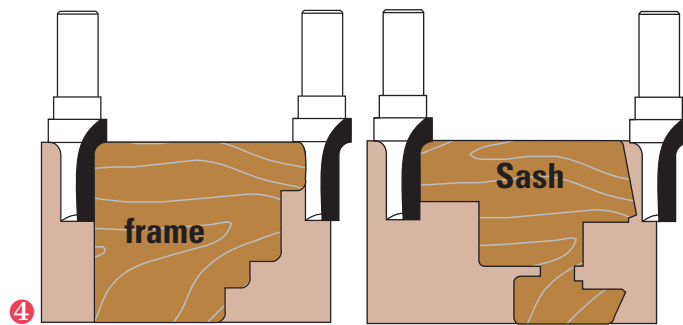

- 4 **Inner-outer frame and sash outlining using a portable electric router fitted on the equipment**
(use tool Art. E.199.200.R).

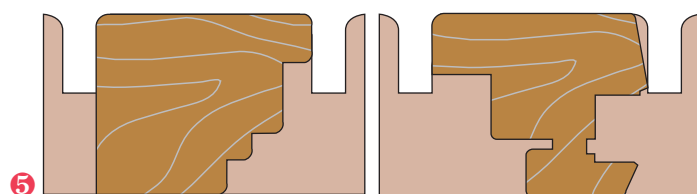

- 5 **Using the band saw, remove excess wood**

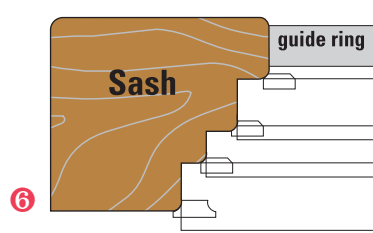

- 6 **Profiling the frame by means of the cutter units with copy bearing on moulding machine**

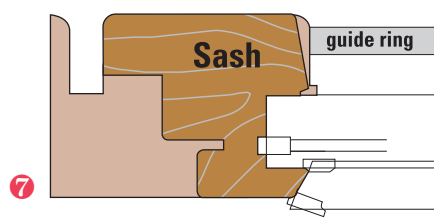

- 7 **Profiling the sash by means of the cutter units with copy bearing on moulding machine**

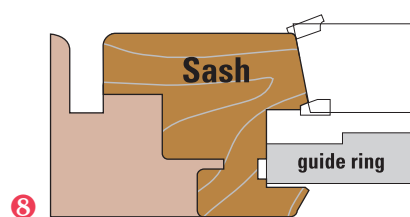

- 8 **Profiling the glazing bead by means of the cutter units with copy bearing on moulding machine**



- 9 **Shaping of the glazing bead** (with cutter Art. E.199.165.R use router table Art. SPP060028 ballbearing guide Art. SPP060039).

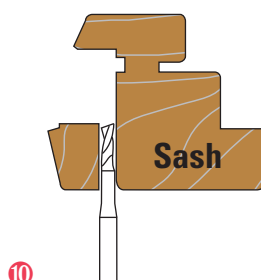

- 10 **Separation of glazing bead with cutter Art. T141.061.R.**

“ARKADE+ZINKEL+ELLIX”

The only equipment on the market capable of producing single and double radius arches or elliptical frames

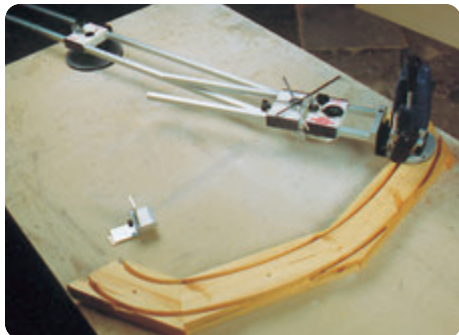

The window arch is worked continuously
It does not require a specific work bench
The goniometer shows exactly how to cut the wood sections making up the arch

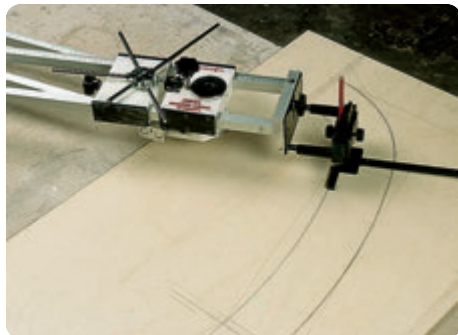

Drawing is done before making the window
A carpenter's pencil is used
Bars are engraved

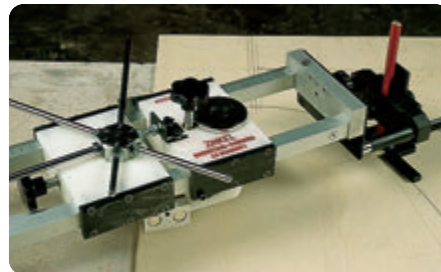

Thanks to the revolver, the frame measurements can be repeated without risk of error



With the router table accessory and the ballbearing guide the execution of glazing bead is quick and easy.



With the equipment “ELLIX” a perfect geometrical ellipse can be executed



Uses standard electric router

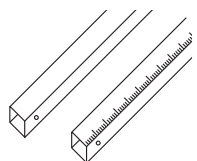

Item	Description
SPP060037	Additional 1.500 mm bars

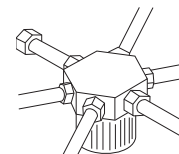

Item	Description
SPP060036	Additional revolver

TOOLS TO BE USED WITH THESE EQUIPMENTS

Shank Ø8	Shank Ø12	Description	
C199.140.R	E199.140.R	T.C.T. beading bit	
C199.165.R	E199.165.R	T.C.T. beading bit	
C199.200.R	E199.200.R	T.C.T. beading bit	
T141.061.R	T141.061.R	Solid carbide bit for glass fixing lath	
U211.061.R	U211.061.R	HS upcut spiral bits for aluminium	
	Z001.006.N	Bushing Ø 6/12	
Z001.001.N		Bushing Ø 6/8	
TS140.96030		Profil cutter hole Ø 30/35/40	
TS140.96035		Profil cutter hole Ø 30/35/40	
TS140.96040		Profil cutter hole Ø 30/35/40	

TRIMATIC FOR HINGES

TRIMATIC are drilling jigs which allow making holes required in a single pass using a normal pillar drill or a portable electric drill. These articles are dedicated to craftsmen and hobbyists who have drilling problems when fitting hinges or positioning shelves with holes at a distance between centres of 32 mm.

The **TRIMATIC** unit with three tool-holders is suitable to make the three holes to fix the hinge in a single pass with distance between centres depending on the hinge to be fixed. Tools diameter depends on the hinge used. The central bit must have right hand rotation, the lateral bits have left hand rotation.

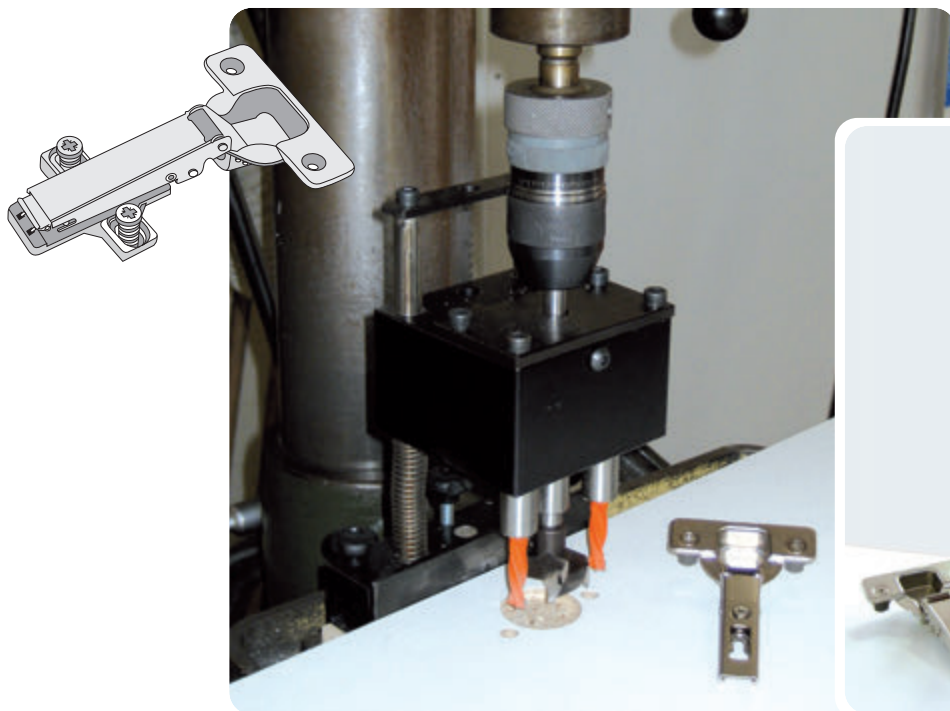

TRIMATIC 48/6 used with a pillar drilling machine



TRIMATIC 48/6 used with a portable drilling machine



Item	
TRIMATIC 38/7,5	Mini-hinges

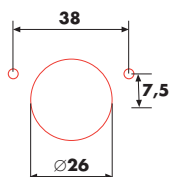

TRIMATIC 42/11	for hinges type "Grass"
----------------	-------------------------

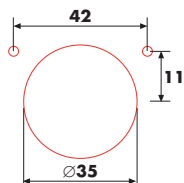

TRIMATIC 45/9,5	for hinges type "Blum"
-----------------	------------------------

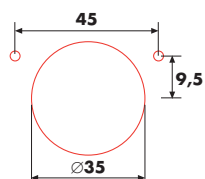

TRIMATIC 48/6	for hinges type "Salice"
---------------	--------------------------

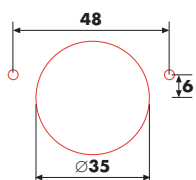

Item	
TRIMATIC 48/9	for hinges type "Mepla"

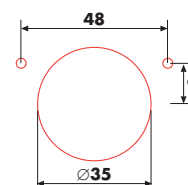

TRIMATIC 52/5,5	for hinges type "Hettich"
-----------------	---------------------------

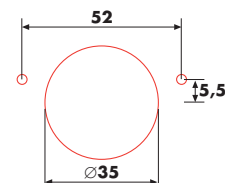

TRIMATIC 52/9	for hinges type "Hafele"
---------------	--------------------------

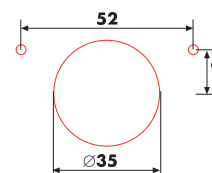

TRIMATIC 52/7,5	hinges for large thickness
-----------------	----------------------------

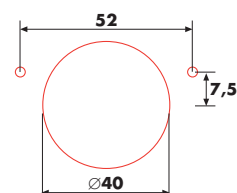

Designed in 1998 is one of the most innovative products in the woodworking field. Tested and appreciated by the most important hinges manufacturers, only our TRIMATIC boring jigs allow making more than **50.000** bores.

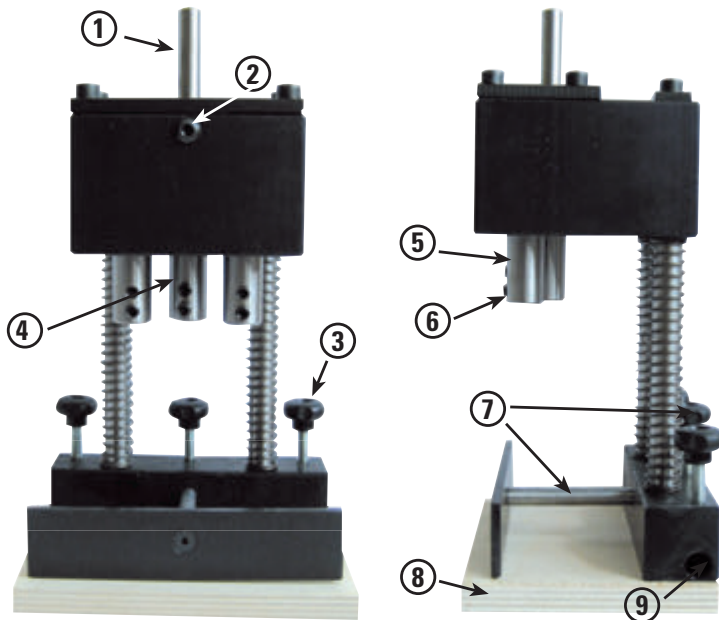

DESCRIPTION

- 1) Arbor for pillar drill spindle
- 2) Threaded hole for greasing
- 3) Locking knob for stop reference rod
- 4) Distance adjusting screw "B"
- 5) Tool holder bush
- 6) Tool locking screw
- 7) Distance adjusting screw "A"
- 8) Equipment support table
- 9) Stop rod sliding hole

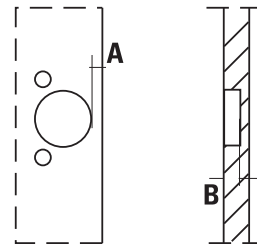

HW tools suitable for TRIMATIC

∅	Rotation	Description
3	Lh	L120.030.L + Z011.030.N
5	Lh	L103.050.L
8	Lh	L103.080.L
10	Lh	L103.100.L
26	Rh	L140.260.R
35	Rh	L140.350.R
40	Rh	L140.400.R

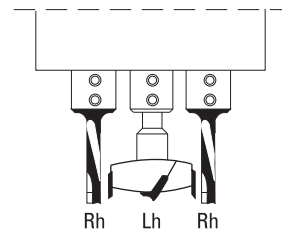

The central bit must have right hand rotation, the lateral bits have left hand rotation

DIMENSIONS

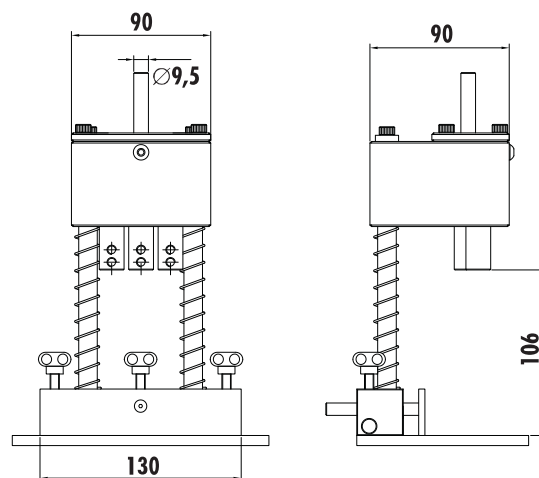

TRIMATIC 32

The **TRIMATIC** unit with five tool holders is suitable to make a five holes set with distance between centres of 32 mm. in a single pass. This device is designed for drilling holes in lateral panels (sides) of furniture for both fixing the hinge and positioning the shelves at the height desired. In the **TRIMATIC 32** the tool diameters depend on the fittings used. The central bit and those mounted in the external positions have right hand rotation, the other tools have left hand rotation.

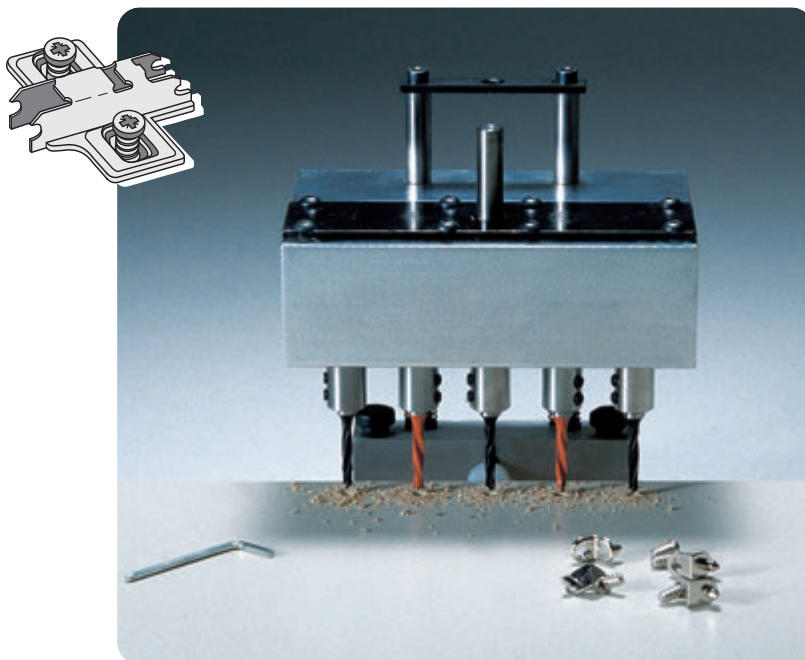

Item
TRIMATIC 32

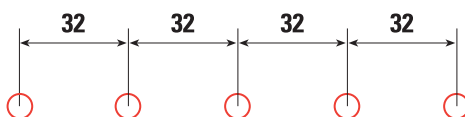

HW tools suitable for TRIMATIC 32

Ø	Rotation	Description
4	Rh	L103.040.R
4	Lh	L103.040.L
5	Rh	L103.050.R
5	Lh	L103.050.L

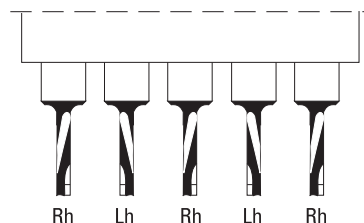

DIMENSIONS



The central bit and those mounted in the external positions have right hand rotation, the other tools have left hand rotation.

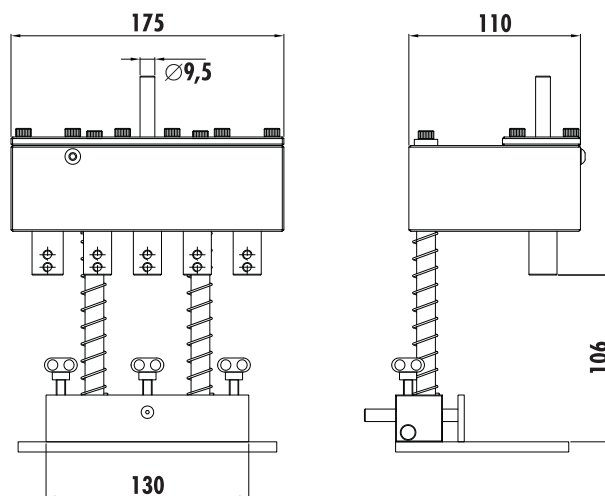

DRILLING FOR CREMONE BOLTS

TRIMATIC 43/0 was designed for window frame makers who have problems with drilling holes to fit the handle on wood, wood/aluminium and PVC windows. **TRIMATIC 43/0** allows drilling the three holes necessary to fit the cremone bolt in one single pass with a normal pillar drill or a portable electric drill.

TRIMATIC 43/0, a drilling jig for handles with a distance between centres of the retaining screws of 43 mm.

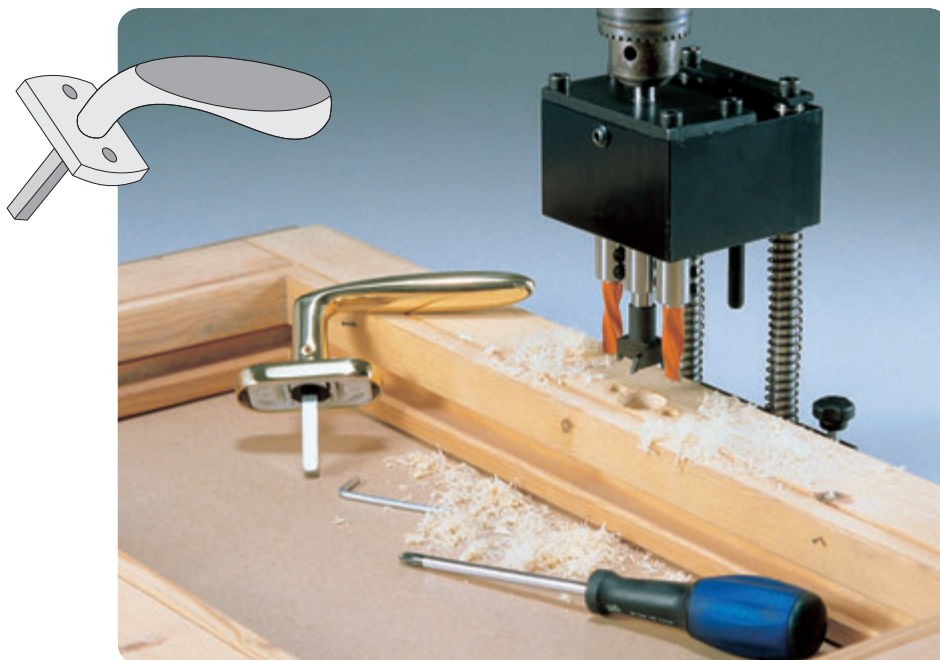

Drilling of wood and PVC window frames to fit cremone bolts

Item
TRIMATIC 43/0

HW tools suitable for TRIMATIC 43/0

Ø	Rotation	Description
4	Rh-Lh	L103.040.R/L
5	Rh-Lh	L103.050.R/L
8	Lh	L103.080.L
10	Rh-Lh	L103.100.R/L
12	Rh-Lh	L103.120.R/L
25	Rh	L140.250.R
26	Rh	L140.260.R

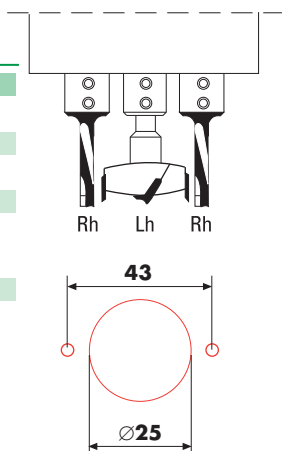

HSS tools suitable for TRIMATIC 43/0 for working PVC and Aluminium

Ø	Rotation	Description
8	Lh	U260.080.L
10	Lh	U260.100.L
12	Rh-Lh	U260.120.R/L
14	Rh	U260.140.R

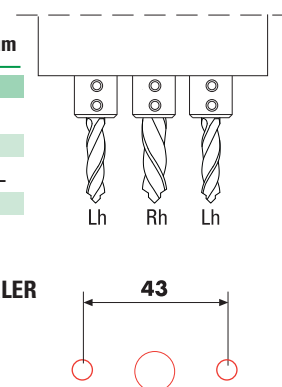

Some examples of drilling patterns

SIEGENIA-TRIAL		WEIDTMANN-KURLER	
U260.120.L	2	U260.100.L	2
U260.120.R	1	U260.140.R	1
G-U JET77		OLIVEN	
U260.100.L	2	U260.080.L	2
U260.120.R	1	U260.1420.R	1



The central bit must have right hand rotation, the lateral bits have left hand rotation.

DIMENSIONS

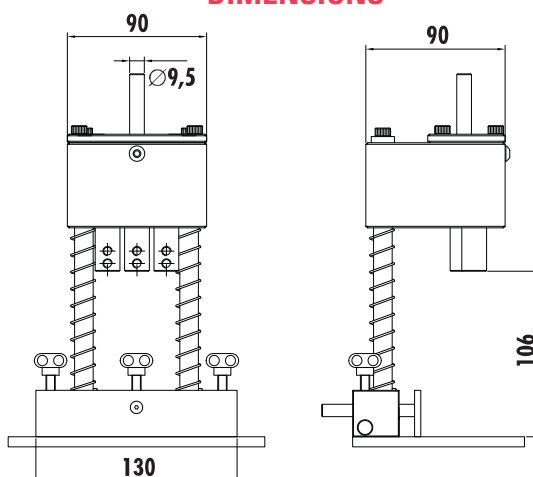

SPECIAL DEVICES FOR ANGULAR HINGES INSERTING

With constant attention paid to our customers' requirements and ongoing research for developing new technical solutions for helping craftsmen and small firms, our special equipments **TRIMATIC 22, 25 e 28** help the window makers to make holes for angular hinges to be mounted on windows and door-windows, in wood and wood-aluminium material. The **TRIMATIC 22, 25 e 28** can be used either with pillar drills or portable electric drills, and have distance between holes suitable for angular hinges of the following types: Siegenia (Trimatic 22), GU (Trimatic 25), Maico and AGB (Trimatic 28).

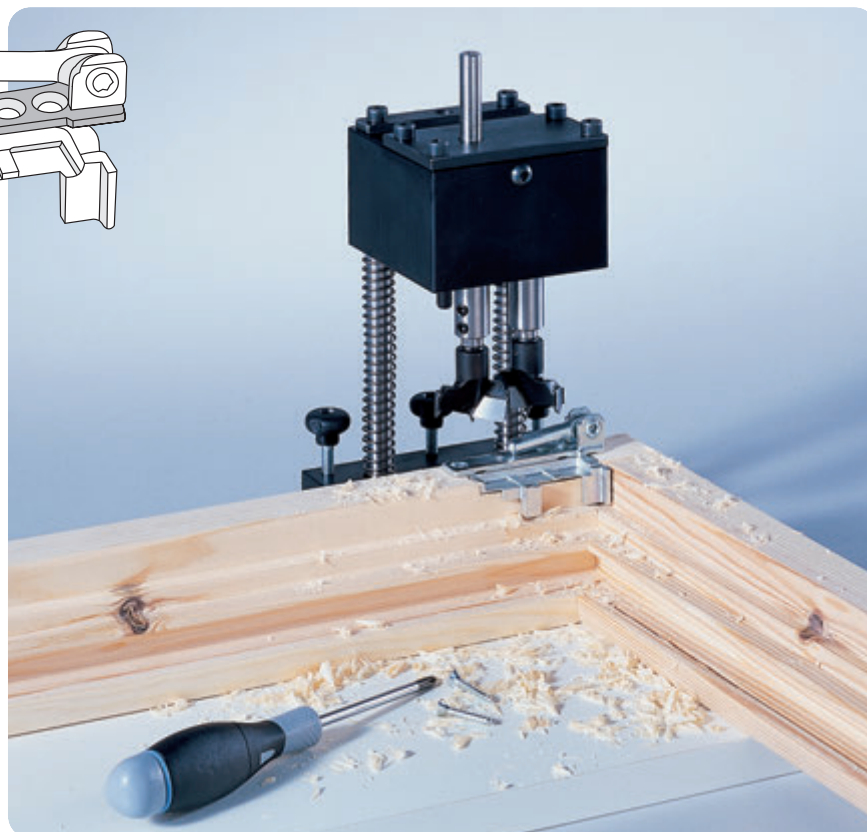
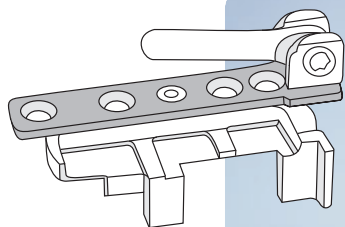

Fixing of edge hinge

Item

TRIMATIC 22 for angular hinges "SIEGENIA" (Ø30 e Ø34) with a distance between holes of 22 mm

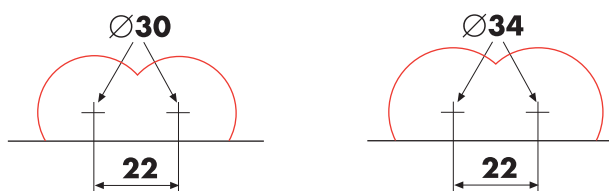

TRIMATIC 25 for angular hinges "GU" with a distance between holes of 25 mm

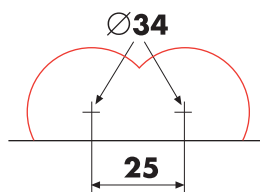

TRIMATIC 28 for angular hinges MAICO (typ "Trend") e AGB with a distance between holes of 28 mm

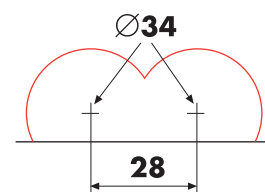

SPECIAL DEVICES FOR ANGULAR HINGES INSERTING

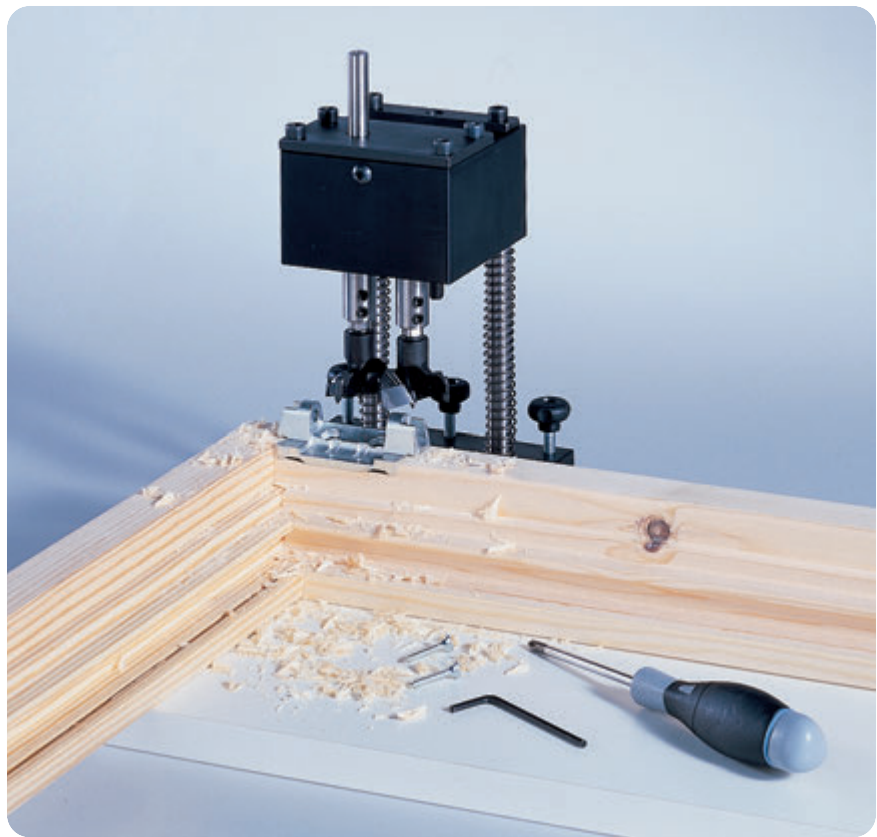

Fixing of top hinge

HW tools suitable for TRIMATIC 22 - 25 - 28

Ø	Rotation	Description
30	Rh	L160.300.R
30	Lh	L160.300.L
34	Rh	L160.340.R
34	Lh	L160.340.L

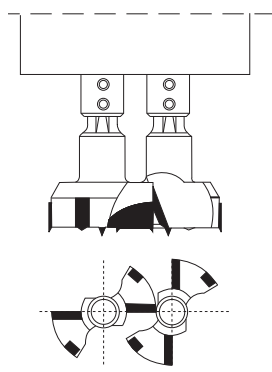

DIMENSIONS

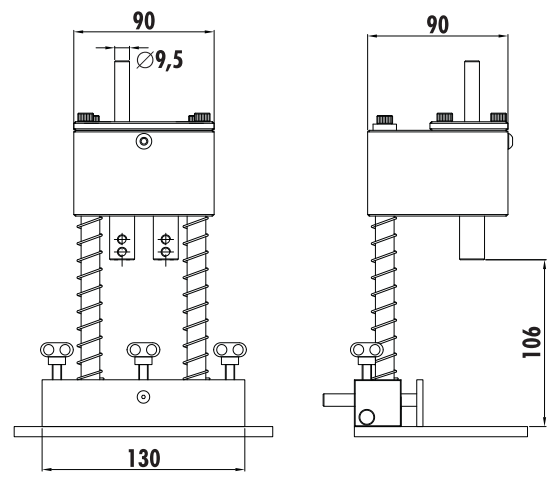

DRILLING JIG FOR MAKING HOLES FOR HINGE INSERTING

The **TRIMATIC SUPER** is a very innovative drilling jig, suitable to solve many problems to craftsmen and small industries when fitting the hinges and handles on doors, windows and cabinet doors. The **TRIMATIC SUPER** can be easily and quickly mounted on the multi-spindles head of any automatic boring machine with 32 mm distance between centres chucks. The **TRIMATIC SUPER** is very precise and fast, making in one single pass the three holes required for fitting the hinges on the cabinet doors.

At the moment, 8 types **TRIMATIC SUPER** in different patterns are available, suitable for the most common hinges: Salice, Blum, Hettich, Grass, Mepla, Ferrari, ecc. The new model 43/0, is now available for the execution of the holes necessary to fit the cremone bolt on the handles of doors and windows. The **TRIMATIC SUPER** are small-sized, 12,5x5x3 cm, but they are very solid and long-lasting devices. The diameter of the drills has to be chosen with reference to the model of hinges being used. Now, just choose the type of **TRIMATIC SUPER** you need.

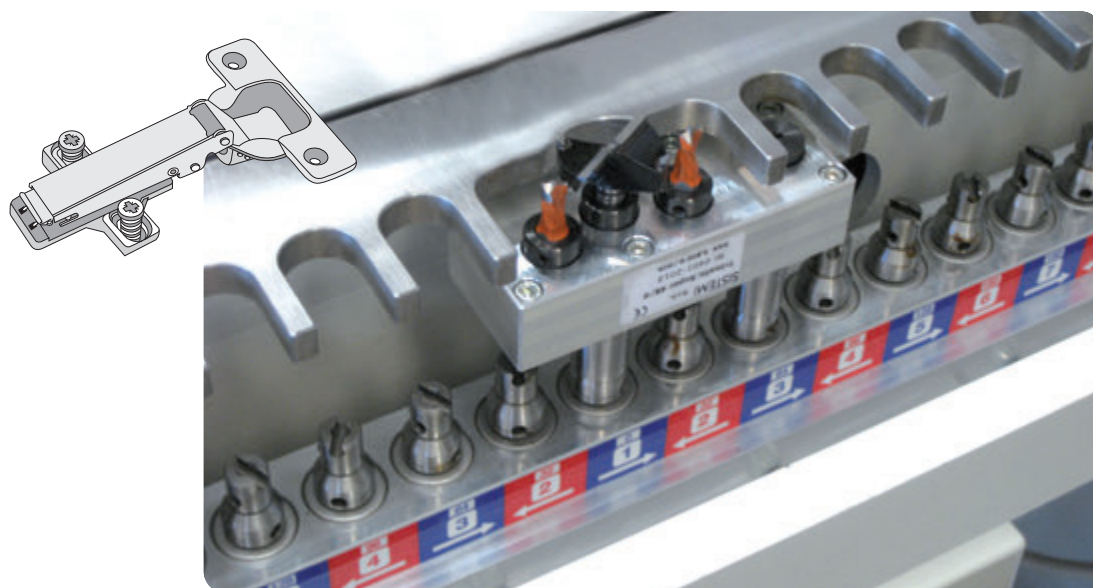

Item

TRIMATIC SUPER 38/7,5 Mini-hinges

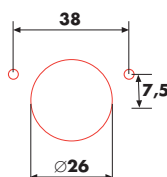

TRIMATIC SUPER 42/11 for hinges type "Grass"

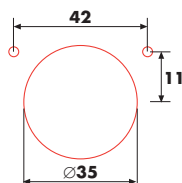

TRIMATIC SUPER 45/9,5 for hinges type "Blum"

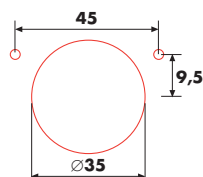

TRIMATIC SUPER 48/6 for hinges type "Salice"

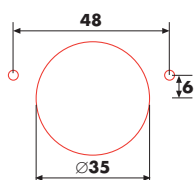

item

TRIMATIC SUPER 48/9 for hinges type "Mepla"

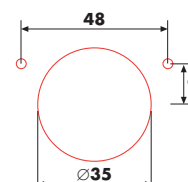

TRIMATIC SUPER 52/5,5 for hinges type "Hettich"

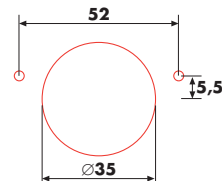

TRIMATIC SUPER 52/9 for hinges type "Hafele"

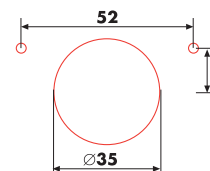

TRIMATIC SUPER 52/7,5 hinges for large thickness

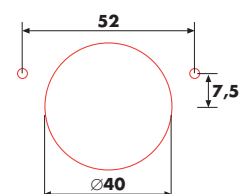

DRILLING JIG FOR MAKING HOLES FOR HINGE INSERTING



HW tools suitable for TRIMATIC SUPER

Ø	Rotation	Description
3	Lh	L120.030.L + Z011.030.N
5	Lh	L171.050.L
8	Lh	L171.080.L
10	Lh	L171.100.L
26	Rh	L170.260.R
35	Rh	L170.350.R
40	Rh	L170.400.R

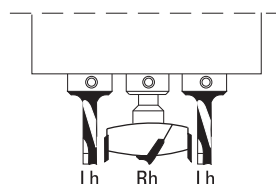

DIMENSIONS

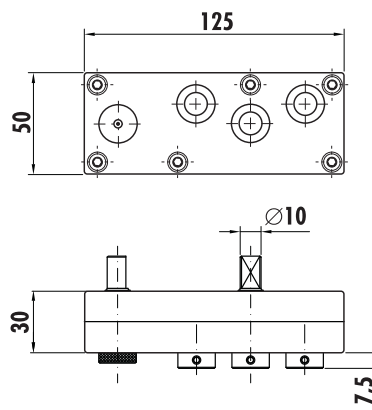

The central bit must have right hand rotation, the lateral bits have left hand rotation.

DRILLING OF WOOD AND PVC WINDOW FRAME TO FIT CREMONE BOLT

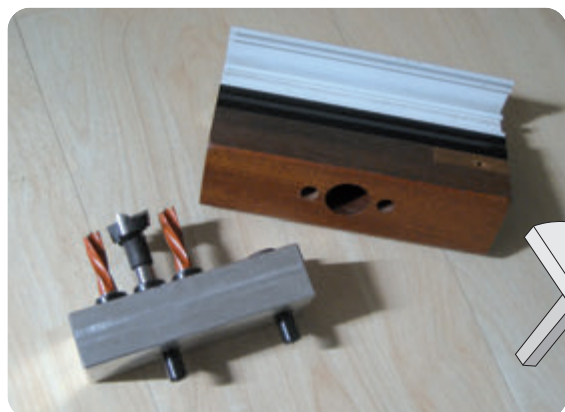

Item
TRIMATIC SUPER 43/0

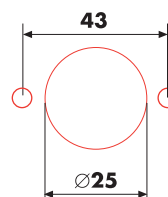

HW tools suitable for TRIMATIC SUPER 43/0

Ø	Rotation	Description
10	Lh	L103.100.L
12	Lh	L103.120.L
25	Rh	L140.250.R

DRILLING JIG FOR MAKING HOLES FOR HINGE INSERTING

TRIMATIC SUPER 32/90° allows to drill at a same time 2 holes perpendicular to the machine boring axis.

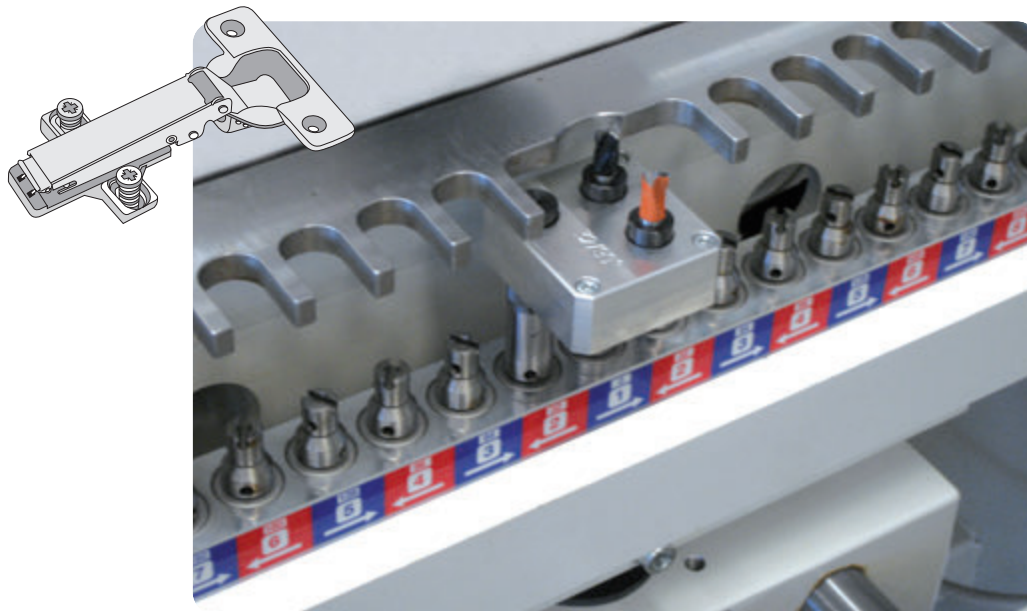

TRIMATIC SUPER 32/90° drilling jig for multi spindles machines 32 mm

Item

TRIMATIC SUPER 32/90°

HW tools suitable for TRIMATIC SUPER 32/90°

Ø	Rotation	Description
20	Lh	L170.200.L
10	Rh	L171.100.R

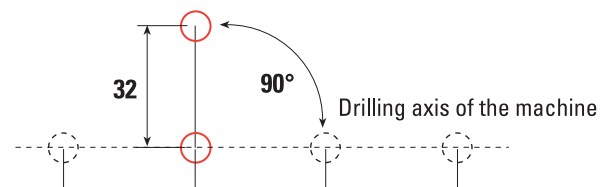

DIMENSIONS

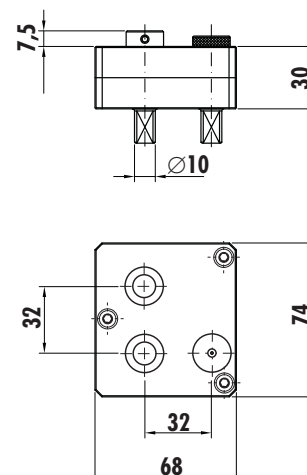
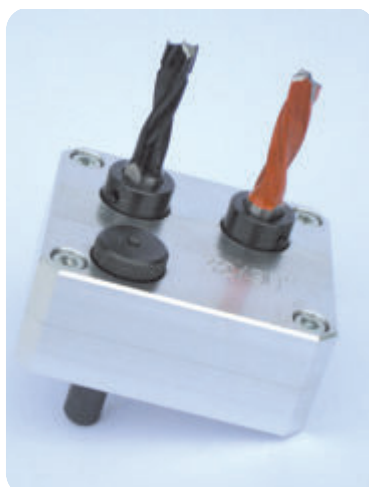

ELECTRIC ROUTER

Wood milling machines are possibly the most versatile machines that exist for woodworking. They can be used to carry out a whole series of finishing operations that would require hour upon hour of hard work and toil with other systems and achieve an unimaginable degree of precision. Although professional operators and woodworkers are fully familiar with its vast array of possibilities, hobbyists often see milling machines as a slightly mysterious tool and approach them with some diffidence. In fact, a milling machine is not a drill. To use it to its full extent, operators must first get to know its great potential, and then start working with it - which requires a certain degree of training. On the other hand, the satisfaction it can give is considerable. Items made as a hobby - often a little awkward and bulky - can be embellished with smooth corners, curves and rounded edges, and traditional, cabinet-making joints can replace joints made using pins or glue. In sum, a whole new world has opened up for do it yourself that was previously off-limits to them. Naturally, all this requires an extra effort, to ensure that customers are adequately informed. This is why we have decided to provide a summary of basic information to be supplied for this type of customer, when they express a desire to approach the world of milling.

High quality and long-lasting machine.

Its technical features, accuracy and performance make it a router for all your requirements.

Item	Description
DB2000E	Electric router power 1900 W

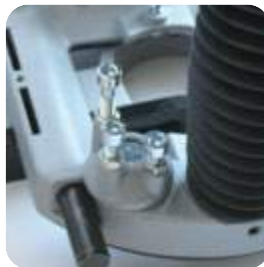
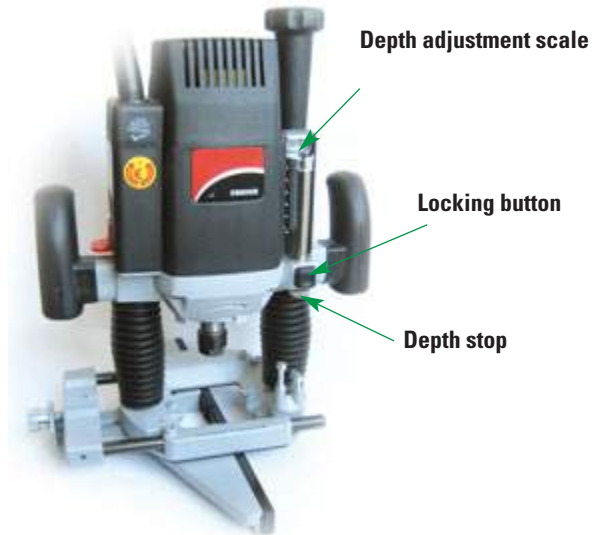

Graduated stop



Transparent protection



Dust extraction hood

TECHNICAL DATA

- Power consumption 1900 W
- Drive shaft speed 10000-22500 r.p.m.
- Tool shaft diameter 12 mm
- Lengthwise sliding 0-67 mm
- Maximum bit diameter 60 mm
- Weight (without accessories) 5,6 kg
- Total machine height 305 mm



STANDARD PACKAGE

- Slide stop
- Clamping collets diam. 12 mm and 8 mm
- Wrenches 22 mm and 8 mm
- Transparent protection
- Dust extraction hood
- Template
- Plastic box
- Instruction manual
- Safety instructions
- Warranty

ECCENTRIC CLAMP

The eccentric clamp is suitable for keeping the glued wood sections with comb joints under pressure. It is tightened and slackened by turning the grip; the eccentric pressors are covered in rubber to prevent damage to the wood.

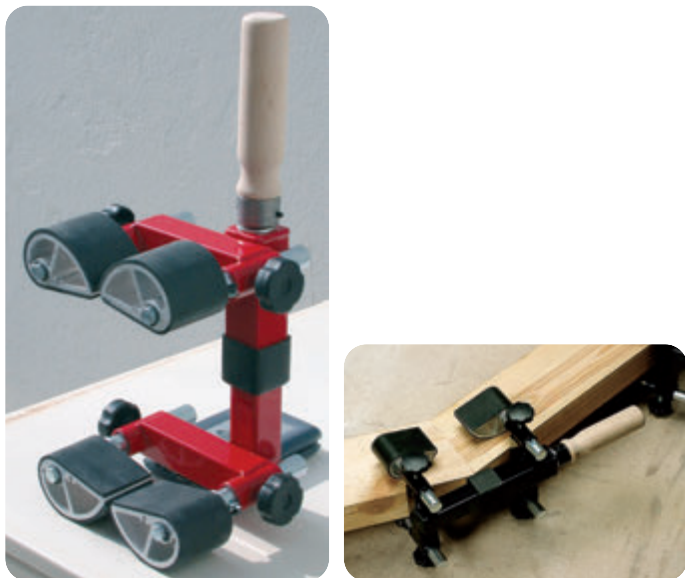

Item	Thickness range
SPP060029	Min. 25 mm - Max 75 mm
SPP060053	Min. 40 mm - Max 90 mm

ROUTER TABLE



Item	Description
SPP060028	Router table to separate the glass fixing lath
SPP060039	Ball bearing guide for router table

DRIVER FOR CURVES

The driver for curves was conceived for greater safety during router machining on curves. It is equipped with a motor sufficient to guarantee a regular feed of about 2 m/min. so that a good quality of finish is obtained. The rubber wheel, apart from not damaging the wood, guarantees the perfect position of the piece with respect to the tools. The driver can already be applied with an arc of 25 cm radius.

2 feed rates=1,39 mt/min. + 2,78 mt/min.



Item	Description
SPP060065	Drivers for curves 2 feed rate

LIFTING CLAMP

The lifting clamp facilitates the handling and transport of large panels. It features an anatomic wooden grip and rubber covered eccentric jaws.



Item	Thickness range
SPP060047	Min. 10 mm - Max 65 mm

EDGE CLAMP

The edge clamp is used to press the wooden lippings against the edge of the panel. The eccentric pressors are covered in rubber. This article is practically indispensable when gluing edge on curved or shaped panels.

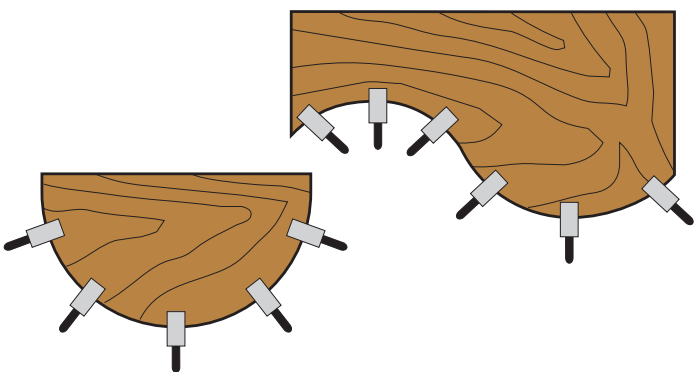
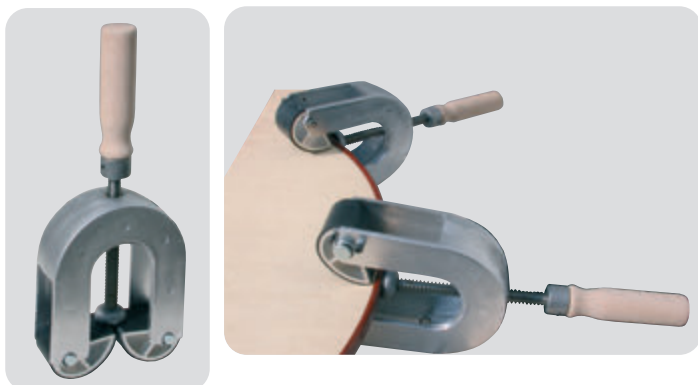

Item	Thickness range
SPP060052	Min. 10 mm - Max 65 mm

T-JOINTS CLAMP

Suitable for T-joints in little pieces of furniture

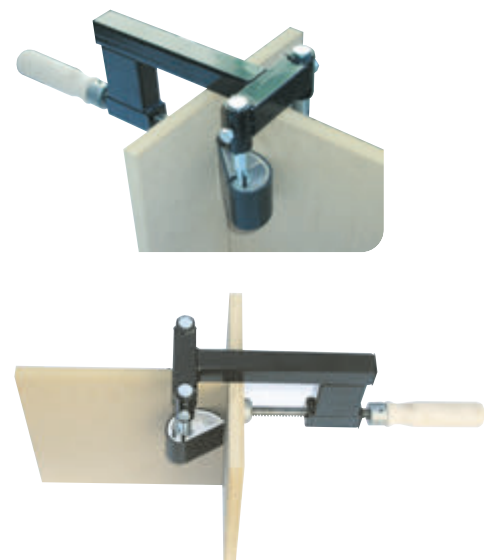

Item	Thickness range
SPP060075	Min. 10 mm - Max 65 mm

CARPENTER'S CLAMP

The carpenter's clamp is suitable for craftsmen who manufacture modern furniture. The clamp is tightened and loosened by turning the wooden handgrip. The ends which hold the panel are covered with ribbed rubber to protect and improve the grip. With a suitable number of extensions furniture of any dimension can be assembled.



Item	Thickness range
SPP020021	Min. 250 mm - Max 800 mm

EXTENSIONS

Item	Thickness range
SPP020022	800 mm

DOOR LIFTER

Lifts, swivels and lowers. Easy foot operation for weights up to 100 kg for the installation of doors including fire doors, windows, furniture, dry walls, partitions.



Item
LIFTER100

QUICK CLAMPING DEVICES

Devices for quick clamping workpieces and for numerous applications. By simply applying pressure on the grip, once dead centre has been passed, they close securely. Horizontal models with horizontal or vertical clamping, push rod and pneumatic. Maximum quality and a virtually unlimited lifespan.



HORIZONTAL TYPE WITH HORIZONTAL CLAMPING

ART. B.ORI



Item	Clamping strength
B.ORI.0240	Kg. 120
B.ORI.0400	Kg. 200
B.ORI.0600	Kg. 300
B.ORI.0700	Kg. 350

HORIZONTAL TYPE WITH VERTICAL CLAMPING

ART. B.VER



Item	Clamping strength
B.VER.0241	Kg. 120
B.VER.0401	Kg. 200
B.VER.0601	Kg. 300
B.VER.0701	Kg. 350

PNEUMATIC TYPE

ART. B.PNE



Operated by a cylinder 6,5 Atm.

Item	Clamping strength
B.PNE.0400	Kg. 200

PUSHER TYPE

ART. B.SPI



Item	Clamping strength
B.SPI.0400	Kg. 220

SPARE ENDPINS made in rubber

Item	Description
B.ORI.0240	M6 for clamps kg. 120
B.ORI.0400	M8 for clamps kg. 200
B.ORI.0600	M10 for clamps kg. 300
B.ORI.0700	M12 for clamps kg. 350

KleinWASHER
Automatic Tool Washer



- Suitable for washing any metal parts
- For tools of various dimensions, also for tool groups for windows
- Heated biological operating mode

Includes:

- Stainless steel housing
- Rotating tank D=550 mm.
- Stainless steel upper, under and lateral washing arms
- Timer
- Thermal resistance
- Single-phase 1 hp pump
- Dimensions: 700x600 h 866mm.
- Dimensions packing: 785x780 h1000mm.
- Weight: 50 kg.

Item	Description
KLEINWASHER NEW	Automatic tool washer

Sealants, lubricants, cleaning products
see section 14 page 14.03

KleinCLEANER
Manual Tool Washer



- Can wash any type of tools or metal parts
- Easy to be used with water and spray gun
- Heated biological operating mode

Includes:

- Spray gun
- Tool holding grid
- Stainless steel tank with thermal resistance
- Air-operated double diaphragm pump 5 L/min.
- Tank dimensions: 600x500 h 250mm.
- Tank capacity: 70L
- Dimensions: 700x560 h1000mm.
- Dimensions packing: 970x670 h1020.
- Weight: 40 Kg.

Item	Description
KLEINCLEANER NEW	Manual tool washer

Sealants, lubricants, cleaning products
see section 14 page 14.03

ANGLE HEADS FOR CNC ROUTERS MACHINES

Please specify:

- Type of tool holder
- Type of Machine and model
- Tool used
- Application

ART. GR1.WZ.SL

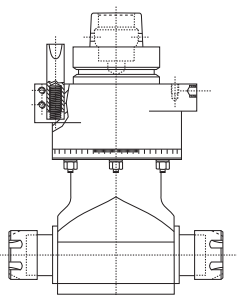

"LIGHT" TYPE
90° double sided angle head

ART. GR1.WD.SL

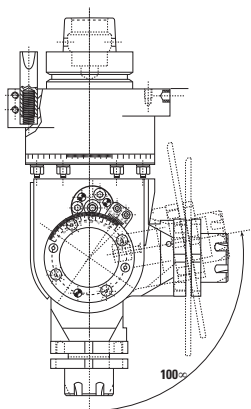

"LIGHT" TYPE
Adjustable angle head 0-100°

ART. GR2.WS.FL

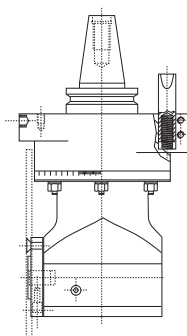

STANDARD TYPE
1-side angle head 90°
(spring collet or sawblade)

ART. GR2.WZ.FL

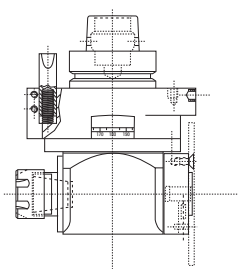

STANDARD TYPE
2-sided angle head 90°
(spring collet or sawblade)

ART. GR2.WV.FL

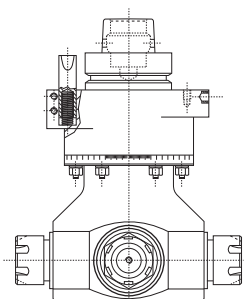

STANDARD TYPE
4-sided angle head 90°
(spring collet) application

ART. GR2.WW.FL

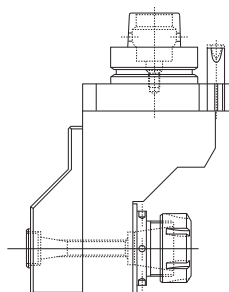

STANDARD TYPE
1-side trimming angle head for locks

ART. GR2.WD.FL

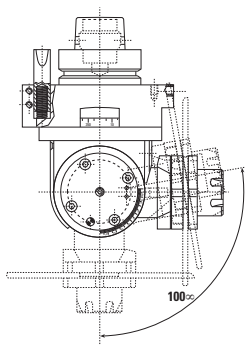

STANDARD TYPE
Adjustable angle head 0-100°
(spring collet or sawblade)

ART. GR3.WS.UL

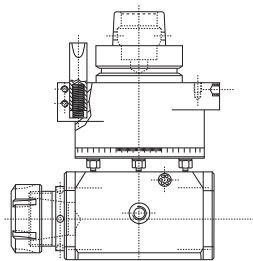

OIL COOLING, HARD-WEARING
1-side angle head 90°

ART. GR2.W1.FL

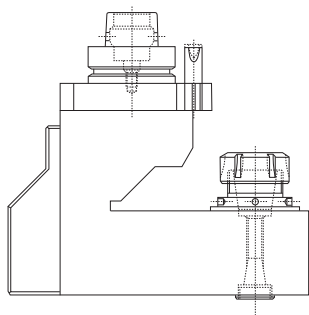

STANDARD TYPE
1-side undersurface
trimming angle head

ART. GR3.WZ.UL

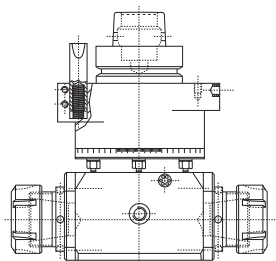

OIL COOLING, HARD-WEARING
90° double sided angle heads

ART. GR2.W2.FL

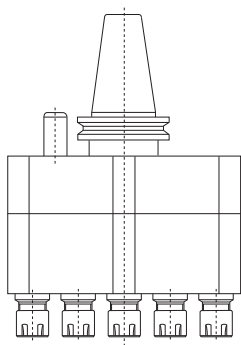

STANDARD TYPE
Multi spindle angle
head 5-sided
**Similar devices suitable
for boring machines
available on request**

ART. GR3.WX.UL

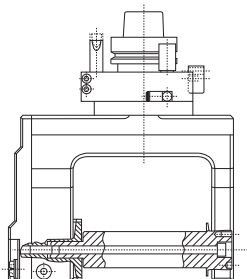

OIL COOLING, HARD-WEARING
1-side 90° angle head with arbor
for cutters

ART. GR3.WD.UL

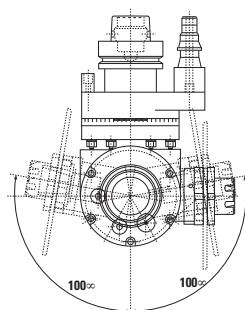

OIL COOLING, HARD-WEARING
Adjustable angle head -100°+100°
(spring collet and sawblade)

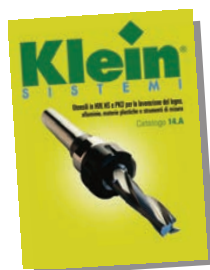

FRESE HW CON CUSCINETTO SUPERIORE Z=2

HW FLUSH TRIM BITS WITH UPPER BALL BEARING GUIDE Z=2

ART. A160 - B160 - C160

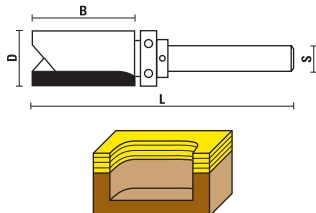

- Adatte per refillare e fresare su qualsiasi tipo di legno e suoi derivati.
- **Gamma completa alla pagina 1.19 del nostro Catalogo 14.A**
- *Suitable for trimming and milling on every type of wood.*
- **Full range at page 1.19 of our Catalog 14.A**



S Ø 6	S Ø 6,4 (1/4")	D	B	L
A160.125.R	B160.125.R	12,7	13	55
A160.126.R	B160.126.R	12,7	19	55



Z050.007.N



Z058.001.N



Z051.005.R

S Ø 8	D	B	L
C160.161.R	16	32	69



Z050.018.N



Z058.004.N



Z051.005.R

FRESE HW A RAGGIO CONVESSO CON CUSCINETTO SUPERIORE Z=2

HW CORE BOX BITS WITH UPPER BALL BEARING Z=2

ART. A165 - B165 - C165

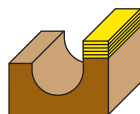
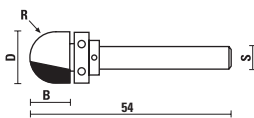

- Adatte per intagliare e ottenere scanalature su qualsiasi tipo di legno e suoi derivati.
- **Gamma completa alla pagina 1.20 del nostro Catalogo 14.A**
- *Suitable for cutting round-bottom groove that can be both decorative and functional on every type of wood.*
- **Full range at page 1.20 of our Catalog 14.A**



S Ø 6	S Ø 6,4 (1/4")	S Ø 8	D	R	B
A165.160.R	B165.160.R	C165.160.R	16	8	11



Z050.018.N



Z058.004.N



Z051.005.R

S Ø 6	S Ø 6,4 (1/4")	D	R	B
A165.190.R	B165.190.R	19	9.5	11



Z050.006.N



Z058.005.N



Z051.005.R

S Ø 8	D	R	B
C165.190.R	19	9.5	11



Z050.026.N



Z058.006.N



Z051.005.R

FRESE HW PER CIOTOLE E VASSOI CON CUSCINETTO SUPERIORE Z=2

HW BOWL AND TRAY BITS WITH UPPER BALL BEARING Z=2

ART. C166

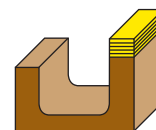
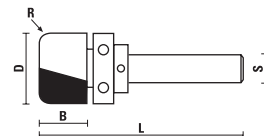

- Adatte per ciotole, vassoi, taglieri e altri articoli che necessitano di bordi alti e una superficie più bassa e liscia.
- **Gamma completa alla pagina 1.20 del nostro Catalogo 14.A**
- *Suitable for making custom bowls, boxes, plates in any shape you can cut template for.*
- **Full range at page 1.20 of our Catalog 14.A**



S Ø 8	D	R	B	L
C166.190.R	19	6,4	16	67



Z050.026.N



Z058.006.N



Z051.005.R

FRESE HW PER CIOTOLE E VASSOI Z=2

HW BOWL AND TRAY BITS Z=2

ART. A196 - B196 - C196

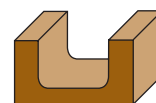
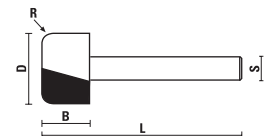

- Adatte per ciotole, vassoi, taglieri e piatti.
- *Suitable for cutting hollows into bowls, boxes, plates, serving trays and spoon.*



S Ø 6	S Ø 6,4 (1/4")	S Ø 8	D	R	B	L
A196.110.R	B196.110.R	C196.110.R	11	3	12,7	54
A196.190.R	B196.190.R	C196.190.R	19	6,4	16	60



FRESE HW PER MACCHINE "FESTOOL"® Z=2 HW ROUTER BITS FOR "FESTOOL"® MACHINES Z=2

ART. F160 - F161



- Da utilizzare su elettrofresatrici Festool® "Domino DF500"
- Adatto per giunzioni "Domino"® per la realizzazione di cornici, cassetti, corpi di mobili, antine e giunti
- Gamma completa alla pagina 3.15 del nostro Catalogo 14.A

- To be used on Festool® joining machines "Domino DF500"
- Suitable for creating dowel cross-cut for making Domino® joints for frames, drawers, cabinets and furniture
- Full range at page 3.15 of our Catalog 14.A



S = M6x0,75

F160.040.R ▲ NEW

D
4

B
11

L
38

▲ HW integrale/Solid carbide

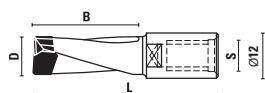

- Da utilizzare su elettrofresatrici Festool® "Domino XL DF700"
- Adatto per giunzioni "Domino"® per la realizzazione di antine, tavoli, porte e telai

- To be used on Festool® joining machines "Domino XL DF700"
- Suitable for creating dowel cross-cut for making Domino® joints for kitchen cabinets, tables and door frames



S = M8x1

F161.080.R NEW

D
8

B
50

L
90

F161.100.R NEW

10

70

90

F161.120.R NEW

12

70

90

F161.140.R NEW

14

70

90

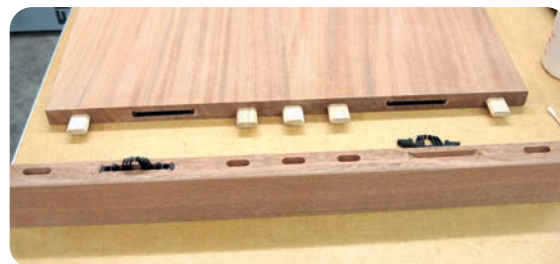

PUNTE HW INTEGRALE FORI CIECHI Z=2, RICOPERTE Klein^{DIA} VHW DOWEL DRILLS Z=2, Klein^{DIA} COATED

ART. L116.KD - L117.KD

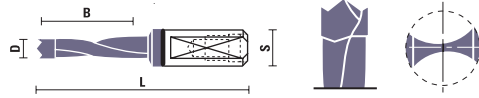

Xtra[®] **Durata 4 volte superiore all'utensile non ricoperto**
bore **Tool life 4 times longer than uncoated tools**

- Affilatura **EXTRA TIME** (incisore arrotondato, centrino rinforzato)
- Corpo in **HW integrale** (esecuzione con 2 eliche)
- **Tagliente lappato e ricoperto per un minore attrito e una migliore fuoriuscita del truciolo**
- **Ottima finitura dei fori**
- **Elevatissima durata dell'utensile e migliori performance**
- Per legno naturale, pressato, agglomerato, impiallacciato, laminato e carta
- Indicato anche per lavorare **Trespa[®]** e melaminici
- **EXTRA TIME** grinding tool (rounded spurs and reinforced centering point)
- **Solid carbide spiral portion** (with 2-flutes)
- **Polished and coated cutting edge for improved chip evacuation and less friction**
- **Special HW** more resistant
- **Excellent finish and longer tool life for excellent performance**
- For natural wood, pressed wood, veneered, chipboard, laminated and MDF
- Suggested also for working **Trespa[®]** and melamine panels

Rot. Dx/Rh Rot.	Rot. Sx/Lh Rot.	D	B	L	S
L116.030.RKD	L116.030.LKD	3	20	57,5	10X32
L116.040.RKD	L116.040.LKD	4	23	57,5	10X27
L116.050.RKD	L116.050.LKD	5	23	57,5	10X27
L116.060.RKD	L116.060.LKD	6	23	57,5	10X27
L116.080.RKD	L116.080.LKD	8	23	57,5	10X27
L117.030.RKD	L117.030.LKD	3	20	70	10x38
L117.040.RKD	L117.040.LKD	4	30	70	10x30
L117.050.RKD	L117.050.LKD	5	30	70	10x30
L117.060.RKD	L117.060.LKD	6	30	70	10x30
L117.080.RKD	L117.080.LKD	8	30	70	10x30



Z051.302.R



Z059.001.L



Z059.001.R

Su richiesta
on request



Z051.505.R

PUNTE COMPONENTI HW PER FORI PASSANTI Z=2 VHW THROUGH HOLE DRILL BITS Z=2

ART. L129

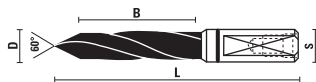

- Corpo in **HW integrale** (esecuzione con 2 eliche)
- Per legno naturale, pressato, agglomerato, impiallacciato e laminato
- **Affilatura in super finitura** che consente una maggiore durata dell'utensile e una migliore resa grazie a una migliore evacuazione del truciolo.
- Particolarmente indicato per la foratura di pannelli con rivestimenti difficili da lavorare
- **Gamma completa alla pagina 5.14 del nostro Catalogo 14.A**
- **Solid carbide spiral portion** (with 2-flutes)
- For natural wood, pressed wood, veneered, chipboard, laminated and MDF
- Made with an exclusive carbide and a **mirror finish quality**. This process will reduce the friction and produce clean and smooth cuts with longer tool life and better performances.
- Best choice when working panels with special coating
- **Full range at page 5.14 of our Catalog 14.A**

Rot. Dx/Rh Rot.	Rot. Sx/Lh Rot.	D	B	L	S
L129.030.R NEW	L129.030.L NEW	3	20	70	10x30
L129.040.R NEW	L129.040.L NEW	4	30	70	10x30



Z051.302.R



Z059.001.L



Z059.001.R

Su richiesta
on request



Z051.505.R

PUNTE FORO PASSANTE HW INTEGRALE Z=2, RICOPERTE Klein^{DIA} VHW THROUGH HOLE DRILL BITS Z=2, Klein^{DIA} COATED

ART. L129.KD

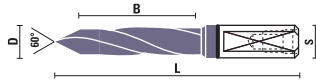





Xtra[®]
bore

**Durata 4 volte superiore
all'utensile non ricoperto**

*Tool life 4 times longer
than uncoated tools*

- Corpo in HW integrale (esecuzione con 2 eliche)
- Tagliente lappato e ricoperto per un minore attrito e una migliore fuoriuscita del truciolo
- Elevatissima durata dell'utensile e migliori performance
- Per legno naturale, pressato, agglomerato, impiallacciato e laminato
- Particolarmente indicato per la foratura di pannelli con rivestimenti difficili da lavorare

- Solid carbide spiral portion (with 2-flutes)
- Excellent finish and longer tool life
- Polished and coated cutting edge for improved chip evacuation and less friction
- For natural wood, pressed wood, veneered, chipboard, laminated and MDF
- Best choice when working panels with special coating

Rot. Dx/Rh Rot.	Rot. Sx/Lh Rot.	D	B	L	S
L129.050.RKD	L129.050.LKD	5	30	70	10x30
 Z051.302.R	 Z059.001.L	 Z059.001.R	Su richiesta on request  Z051.505.R		

PUNTE FORO PASSANTE HW INTEGRALE Z=2 SERIE "ET", RICOPERTE Klein^{DIA} VHW THROUGH HOLE DRILL BITS Z=2 "E.T." LINE, Klein^{DIA} COATED

ART. L134.KD - L135.KD

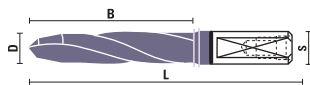





Xtra[®]
bore

**Durata 4 volte superiore
all'utensile non ricoperto**

*Tool life 4 times longer
than uncoated tools*

- Affilatura EXTRA TIME (incisore arrotondato, centrino rinforzato)
- Corpo in HW integrale (esecuzione con 2 eliche)
- Tagliente lappato e ricoperto per un minore attrito e una migliore fuoriuscita del truciolo
- Ottimi risultati di finitura con alte velocità di avanzamento
- Elevatissima durata dell'utensile e migliori performance
- Per legno naturale, pressato, agglomerato, impiallacciato, laminato e carta

- EXTRA TIME grinding tool (rounded spurs and reinforced centering point)
- Solid carbide spiral portion (with 2-flutes)
- Polished and coated cutting edge for improved chip evacuation and less friction
- Excellent finish and longer tool life
- High performance thanks to its double angle geometry
- Special HW more resistant
- For natural wood, pressed wood, veneered, chipboard, laminated and MDF

Rot. Dx/Rh Rot.	Rot. Sx/Lh Rot.	D	B	L	S
L134.050.RKD	L134.050.LKD	5	28	58	10x20
L134.080.RKD	L134.080.LKD	8	28	58	10x20
L135.040.RKD	L135.040.LKD	4	40	70	10x20
L135.050.RKD	L135.050.LKD	5	40	70	10x20
L135.060.RKD	L135.060.LKD	6	40	70	10x20
L135.080.RKD	L135.080.LKD	8	40	70	10x20
 Z051.302.R	 Z059.001.L	 Z059.001.R	Su richiesta on request  Z051.505.R		

PORTAUTENSILI CONO ISO 30 COLLET CHUCKS ISO 30

ART. T118

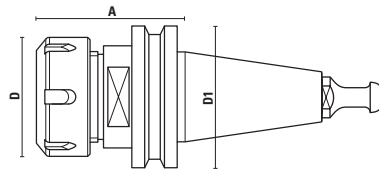

- Viene fornito completo di ghiera e tirante (senza pinza)
- Ghiera e chiave a pag. 7.26, pinza a pag. 7.20
- Ghiera DIN 6499
- La quota "A" è rilevata con l'utensile montato su nostra pinza DIN6499. Da notare che la quota "A" può subire variazioni in base al diametro dell'utensile in pinza
- Supplied with nut (without collet) and retaining pawl
- Threaded nut and wrenches see page 7.26, spring collets see page 7.20
- Threaded nut DIN 6499
- The "A" measure will be determined with clamped tool shanks by using our spring collet DIN6499.
- The "A" measure may be subject to variations depending on the diameter of the clamped tools

- Tirante/Retaining pawl T118.891.R per macchine/for. Biesse (dopo il 09/09/92), Masterwood - Bulleri (motori H.S.D.)

Articolo/Item	A	D	D1	Pinze/Spring collets	Ghiera/Clamping nut	Rot.
T118.798.R NEW	50	42	50	∅ 3÷16 (Art. T125/ER25)	Z091.103.R	Dx/Rh

PORTAUTENSILI CONO HSK-50F COLLET CHUCKS HSK-50F

ART. T118

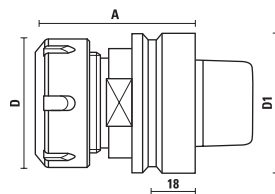

- Viene fornito completo di ghiera (senza pinza)
- Ghiera e chiave a pag. 7.26, pinza a pag. 7.20, 7.22
- Ghiera DIN 6499
- La quota "A" è rilevata con l'utensile montato su nostra pinza DIN6499. Da notare che la quota "A" può subire variazioni in base al diametro dell'utensile in pinza.
- L'attacco conico è costruito secondo la normativa DIN69893 ed è predisposto per l'alloggiamento del microchip "Balluff".
- Supplied with nut (without collet)
- Threaded nut and wrenches see page 7.26, spring collets see pages 7.20, 7.22
- Threaded nut DIN 6499
- The "A" measure will be determined with clamped tool shanks by using our spring collet DIN6499. The "A" measure may be subject to variations depending on the diameter of the clamped tools.
- The hollow taper shank is produced according to DIN69893 for inserting the Balluff microchip.

Articolo/Item	Cono/Type	A	D	D1	Pinze/Spring collets	Ghiera/Clamping nut	Rot.
T118.962.R NEW	HSK-50F	60	42	50	∅ 2÷16 (Art. T125/ER25)	Z091.103.R	Dx/Rh
T118.970.R NEW	HSK-50F	76	63	50	∅ 2÷30 (Art. T123/ER40)	Z091.002.R	Dx/Rh
T118.972.R NEW	HSK-50F	78	63	50	∅ 2÷30 (Art. T123/ER40)	Z091.102.R c/cuscinetto w/ball bearing nut	Dx/Rh

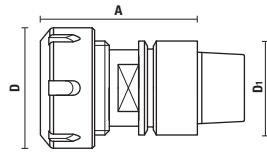
PORTAUTENSILI CONO HSK FORMA "E"
COLLET CHUCKS HSK "E"
ART. T118

- Viene fornito completo di ghiera (senza pinza)
- Ghiera e chiave a pag. 7.26, pinza a pag. 7.20, 7.23
- Ghiera DIN 6499
- **Equilibratura G2,5 x 25.000 g/min**
- La quota "A" è rilevata con l'utensile montato su nostra pinza DIN6499. Da notare che la quota "A" può subire variazioni in base al diametro dell'utensile in pinza.
- L'attacco conico è costruito secondo la normativa DIN69893 ed è predisposto per l'alloggiamento del microchip "Balluff"
- *Supplied with nut (without collet)*
- *Threaded nut and wrenches see page 7.26, spring collets see page 7.20, 7.23*
- *Threaded nut DIN 6499*
- **Balanced to 25.000 RPM at G 2,5**
- *The "A" measure will be determined with clamped tool shanks by using our spring collet DIN6499. The "A" measure may be subject to variations depending on the diameter of the clamped tools.*
- *The hollow taper shank is produced according to DIN69893 for inserting the Balluff microchip*

- Artt. T118.990.R e T118.992.R sono equilibrati a G2,5 x 40.000 g/min per macchine "Multicam"
 - Items T118.990.R and Art. T118.992.R are balanced to 40.000 RPM at G2,5 for "Multicam" machines

Articolo/Item	Cono/Type	A	D	D1	Pinze/Spring collets	Ghiera/Clamping nut	Rot.
T118.990.R NEW	HSK-25E	40	22	25	∅ 2÷10 (Art. T127/ER16)	Z091.405.R Mini	Dx/Rh
T118.991.R NEW	HSK-32E	60	35	32	∅ 1÷13 (Art. T126/ER20)	Z091.104.R	Dx/Rh
T118.992.R NEW	HSK-32E	60	42	32	∅ 2÷16 (Art. T125/ER25)	Z091.103.R	Dx/Rh
T118.993.R NEW	HSK-40E	80	42	40	∅ 2÷16 (Art. T125/ER25)	Z091.103.R	Dx/Rh
T118.997.R NEW	HSK-50E	80	42	50	∅ 2÷16 (Art. T125/ER25)	Z091.103.R	Dx/Rh
T118.998.R NEW	HSK-50E	100	50	50	∅ 2÷20 (Art. T119/ER32)	Z091.001.R	Dx/Rh

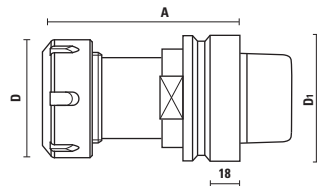
PORTAUTENSILI CONO HSK-63E
COLLET CHUCKS HSK-63E
ART. T118

- Viene fornito completo di ghiera (senza pinza)
- Ghiera e chiave a pag. 7.26, pinza a pag. 7.20, 7.23
- Ghiera DIN 6499
- La quota "A" è rilevata con l'utensile montato su nostra pinza DIN6499. Da notare che la quota "A" può subire variazioni in base al diametro dell'utensile in pinza.
- L'attacco conico è costruito secondo la normativa DIN69893 ed è predisposto per l'alloggiamento del microchip "Balluff".
- *Supplied with nut (without collet)*
- *Threaded nut and wrenches see page 7.26, spring collets see pages 7.20, 7.23*
- *Threaded nut DIN 6499*
- *The "A" measure will be determined with clamped tool shanks by using our spring collet DIN6499. The "A" measure may be subject to variations depending on the diameter of the clamped tools.*
- *The hollow taper shank is produced according to DIN69893 for inserting the Balluff microchip.*

Articolo/Item	A	D	D1	Pinze/Spring collets	Ghiera/Clamping nut	Rot.
T118.985.R100 NEW	100	50	63	∅ 2÷20 (Art. T119/ER32)	Z091.001.R	Dx/Rh

PORTAUTENSILI CONO HSK-63F ER16 - G 2,5
COLLET CHUCKS HSK-63F ER16 - G2.5 BALANCING

ART. TJ118

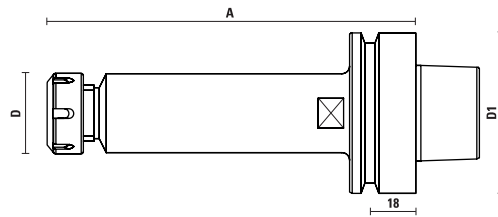

- **Equilibratura G2,5**
- Velocità di rotazione massima **36.000 giri/min**
- Viene fornito completo di ghiera standard
- Ghiera e chiave standard (vedi pag. 7.26 Catalogo 14.A)

- **Balanced at G2.5**
- **Maximum speed rotation at 36.000 RPM**
- **Supplied with standard clamping nut**
- **Threaded nut and wrenches (see page 7.26, Catalog 14.A)**

Articolo/Item	A	D	D1	Pinze/Spring collets	Ghiera/Clamping nut	Rot.
TJ118.900.R150	150	32	63	∅ 2÷10 (Art. T127/ER16)	Z091.105.R	Dx/Rh

PORTAUTENSILI CONO HSK-63F ER32 - G2,5
COLLET CHUCKS HSK-63F ER32 - G2.5 BALANCING

ART. TJ118

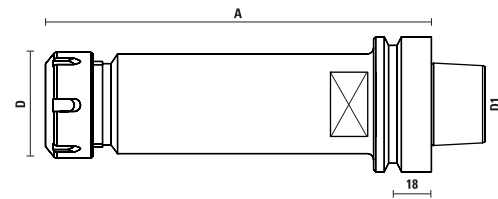

- **Equilibratura G2,5**
- Velocità di rotazione massima **36.000 giri/min**
- Viene fornito completo di ghiera standard
- Ghiera e chiave standard (vedi pag. 7.26 Catalogo 14.A)

- **Balanced at G2.5**
- **Maximum speed rotation at 36.000 RPM**
- **Supplied with standard clamping nut**
- **Threaded nut and wrenches (see page 7.26, Catalog 14.A)**

Articolo/Item	A	D	D1	Pinze/Spring collets	Ghiera/Clamping nut	Rot.
TJ118.976.R075	75	50	63	∅ 2÷20 (Art. T119/ER32)	Z091.001.R	Dx/Rh
TJ118.976.R125	125	50	63	∅ 2÷20 (Art. T119/ER32)	Z091.001.R	Dx/Rh
TJ118.976.R180	180	50	63	∅ 2÷20 (Art. T119/ER32)	Z091.001.R	Dx/Rh

PORTAUTENSILI CONO HSK-63F DIN6388/EOC25 - G2,5
COLLET CHUCKS HSK63F DIN6388/EOC25 - G2.5 BALANCING

ART. TJ118

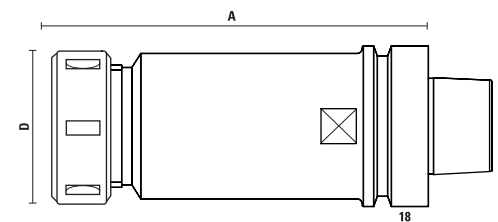

- **Equilibratura G2,5**
- Velocità di rotazione massima **36.000 giri/min**
- Viene fornito completo di ghiera standard
- Ghiera e chiave standard (vedi pag. 7.26 Catalogo 14.A)

- **Balanced at G2.5**
- **Maximum speed rotation at 36.000 RPM**
- **Supplied with standard clamping nut**
- **Threaded nut and wrenches (see page 7.26, Catalog 14.A)**

Articolo/Item	A	D	D1	Pinze/Spring collets	Ghiera/Clamping nut	Rot.
TJ118.984.R078	78	60	63	∅ 3÷26 (Art. T124/EOC25)	Z091.202.R	Dx/Rh
TJ118.984.R115	115	60	63	∅ 3÷26 (Art. T124/EOC25)	Z091.202.R	Dx/Rh
TJ118.984.R150	150	60	63	∅ 3÷26 (Art. T124/EOC25)	Z091.202.R	Dx/Rh
TJ118.984.R200	200	60	63	∅ 3÷26 (Art. T124/EOC25)	Z091.202.R	Dx/Rh

PORTAUTENSILI CONO HSK-63F PER CALETTAMENTO A CALDO
SHRINK FIT CHUCKS HSK-63F

ART. T120

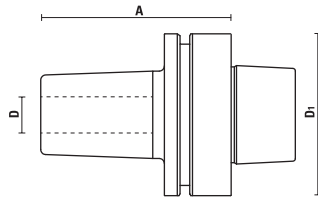
HotBlock®

- Concentricità $\leq 0,003$ mm
- Portautensili ad **alta precisione** grazie alla stretta termica
- Elevata stabilità e rigidità che li rende adatti per lavorazioni particolarmente gravose
- Per utensili in HW e HS
- Grado di **equilibratura G 2,5** x 24.000 RPM
- **Rotazione destra e sinistra**
- Alloggia utensili con gambo cilindrico tolleranza h6
- **Concentricity $\leq 0,003$ mm**
- **High precision** tool holders guaranteed by thermally induced shrink fit
- High rigidity and balance for heavy CNC working
- For HS and HW cutting tool
- **Balanced to 24.000 RPM at G 2,5**
- **Right and left-hand rotation**
- Cutting tool shank must have tolerance h6 with cylindrical shank (no flats)

Articolo/Item	A	D1	D
T120.580.N	76	63	8
T120.600.N	76	63	10
T120.620.N	76	63	12
T120.627.N	76	63	1/2" - (12,7 mm)
T120.660.N	76	63	16
T120.695.N	76	63	3/4" - (19,05 mm)
T120.700.N	76	63	20
T120.750.N	76	63	25

HotBlock®: i portautensili a calettamento sfruttano la dilatazione termica del cono, generata dalla stazione per calettamento (vedi Art. K.START.2), per poterci inserire utensili in HW e HS. Il successivo raffreddamento effettuato tramite il modulo di raffreddamento ad aria (vedi Art. K.FG500) riporta la parte terminale del cono alle dimensioni originarie permettendo così una stretta stabile e sicura degli utensili con la massima precisione di concentricità (≤ 3 micron). Questi speciali coni, creando un'elevata forza di serraggio attorno all'utensile, rendono il sistema estremamente stabile e valido per effettuare operazioni particolarmente gravose.

HotBlock®: high precision tool holders which ensure more precision having less coupling thanks to its special tight on the shank tool by thermal clamping. First, the collet tip is heated with the special shrink fit unit (see our article K.START.2), causing it to expand. The cutter shank is then inserted, and the collet is cooled to ambient temperature with the cooling machine (see our article K.FG500). This causes the collet to contract precisely around the cutter shank with a special concentricity less than 3 micron, therefore the highest precision and stability for high performance.

PROLUNGHE CILINDRICHE PER CONI A CALETTAMENTO A CALDO L=150
SHRINK FIT CHUCK EXTENSIONS L=150

ART. T120

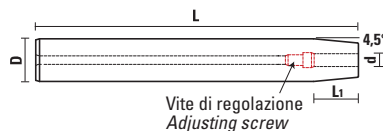

- Adatte per lavorazioni profonde e difficili da raggiungere
- Si raccomanda l'uso su coni a calettamento a caldo (vedi ns. Art. T120) o su coni hydro
- Risultati ottimali su utensili HW e HS con gambo in tolleranza h6
- **Complete di vite di regolazione**
- Suitable for **working deep and hard to reach surfaces**
- To be used with heat shrink fit chucks (our item T120) or hydro chuck
- Best results when clamping HW or HS tools with h6 tool shank
- **With adjusting screw for length adjustment**

Articolo/Item	D	d	L	L1	Vite/Screw
T120.012.03 NEW	12	3	150	12	M5
T120.012.04 NEW	12	4	150	16	M5
T120.016.04 NEW	16	4	150	16	M5
T120.016.06 NEW	16	6	150	26	M5
T120.020.06 NEW	20	6	150	26	M5
T120.020.08 NEW	20	8	150	26	M6
T120.020.10 NEW	20	10	150	32	M6
T120.020.12 NEW	20	12	150	37	M10
T120.025.08 NEW	25	8	150	26	M6
T120.025.10 NEW	25	10	150	32	M6
T120.025.12 NEW	25	12	150	37	M10
T120.025.16 NEW	25	16	150	40	M10

STAZIONE PER CALETTAMENTO

SHRINK FIT UNIT

ART. K.START.2



- Tempo di calettamento da 2 a 7 secondi
- Provvisto di anelli induttore (Ø6 - Ø12) + (Ø14 - Ø20) e di supporto per coni HSK63F
- Riscaldamento localizzato del porta utensile, senza alterazione dell'utensile e del porta utensile
- Autoregolazione della potenza di riscaldamento grazie a un microprocessore interno
- Induttore reversibile a 180° senza smontaggio
- Alimentazione elettrica 3x380/480V – 16A 50/60 Hz -14 kW
- Dimensioni L= 255 mm - P= 490 mm - H= 755 mm
- Peso (senza optional) 20 kg
- Heating time from 2 to 7 seconds
- Provided with inductor stop rings (Ø6 to Ø12) + (Ø14 to Ø20) and chuck holder for HSK63F
- Heating located on the tool holder, no deterioration of the tool and tool holder
- Self-regulated power thanks to a microprocessor depending on parameters detected
- Inductor rotates 180° without disassembling
- Power supply 3x380/480V – 16A 50/60 Hz -14 kW
- Dimensions: L= 255 mm - D= 490 mm - H= 755 mm
- Weight (options excluded) 20 kgs

Articolo/Item

K.START.2

MODULO DI RAFFREDDAMENTO AD ARIA

COOLING UNIT WITH AIR FLOW

ART. K.FG500



- Per il raffreddamento di coni porta utensili a calettare
- Tempi di raffreddamento da 1 minuto e 30 a 3 minuti
- Provvisto di anelli di raffreddamento (Ø6 - Ø12) + (Ø14 - Ø20) e di supporto per coni HSK63F
- Alimentazione pneumatica: 4-6 bar
- Dimensioni L= 220 mm - P= 190 mm - H= 615 mm
- Peso 5 kg
- Air cooling unit for shrink fit chucks
- Cooling time from 1,30 minute to 3 minutes
- Provided with cooling stop rings (Ø6 to Ø12) + (Ø14 to Ø20) and chuck holder for HSK63F
- Compressed air supply: 4-6 bars
- Dimensions: L= 220 mm - D= 190 mm - H= 615 mm
- Weight: 5 kgs

Articolo/Item

K.FG500.1150

GRUPPO/SECTION 7

PROLUNGHE CILINDRICHE PORTAPINZE

ER STRAIGHT SHANK TOOL EXTENSION

ART. T121

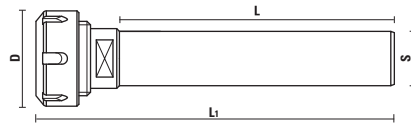

- Da utilizzare su coni portapinza
- Adatte per lavorazioni profonde e difficili da raggiungere
- To be used on ER tool holders
- Suitable for working deep and hard to reach surfaces

Articolo/Item	D	Pinze/Spring collets	Ghiera/Clamping nut	S	L	L1	Rot.
T121.016.120.080 NEW	22	Ø 2÷10 (Art. T127/ER16)	Z091.405.R Mini	12	80	118	Dx/Rh
T121.016.160.100 NEW	22	Ø 2÷10 (Art. T127/ER16)	Z091.405.R Mini	16	100	138	Dx/Rh
T121.016.200.100 NEW	22	Ø 2÷10 (Art. T127/ER16)	Z091.405.R Mini	20	100	131	Dx/Rh
T121.016.200.160 NEW	22	Ø 2÷10 (Art. T127/ER16)	Z091.405.R Mini	20	160	191	Dx/Rh
T121.016.200.200 NEW	22	Ø 2÷10 (Art. T127/ER16)	Z091.405.R Mini	20	200	231	Dx/Rh
T121.020.160.100 NEW	35	Ø 2÷13 (Art. T126/ER20)	Z091.104.R	16	100	146	Dx/Rh
T121.020.160.160 NEW	35	Ø 2÷13 (Art. T126/ER20)	Z091.104.R	16	160	195	Dx/Rh
T121.020.200.100 NEW	35	Ø 2÷13 (Art. T126/ER20)	Z091.104.R	20	100	146	Dx/Rh
T121.020.200.160 NEW	35	Ø 2÷13 (Art. T126/ER20)	Z091.104.R	20	160	206	Dx/Rh
T121.020.250.160 NEW	35	Ø 2÷13 (Art. T126/ER20)	Z091.104.R	25	160	200	Dx/Rh
T121.020.250.240 NEW	35	Ø 2÷13 (Art. T126/ER20)	Z091.104.R	25	260	300	Dx/Rh
T121.025.200.060 NEW	42	Ø 3÷16 (Art. T125/ER25)	Z091.103.R	20	60	106	Dx/Rh
T121.025.200.100 NEW	42	Ø 3÷16 (Art. T125/ER25)	Z091.103.R	20	100	146	Dx/Rh
T121.025.200.160 NEW	42	Ø 3÷16 (Art. T125/ER25)	Z091.103.R	20	160	206	Dx/Rh
T121.025.250.100 NEW	42	Ø 3÷16 (Art. T125/ER25)	Z091.103.R	25	100	140	Dx/Rh
T121.025.250.160 NEW	42	Ø 3÷16 (Art. T125/ER25)	Z091.103.R	25	160	200	Dx/Rh

Esempio d'utilizzo/ Example of use:

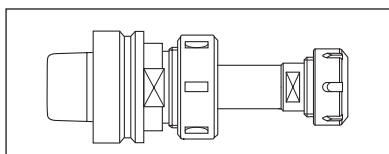

- Per un corretto utilizzo, l'attacco cilindrico della prolunga deve essere inserito per tutta la lunghezza della pinza.
- È importante stringere la ghiera del cono portapinza utilizzando una chiave dinamometrica assicurando la corretta forza di tenuta.
- A prolunga montata sul cono portapinza, il grado di equilibratura non viene garantito.
- For a proper use and maximum holding power, fill the collet all the way with the extension shank;
- It is very important to tighten the collet nut of tool holder to recommended torque using a torque wrench;
- When the extension is mounted, balancing grade is not guaranteed.

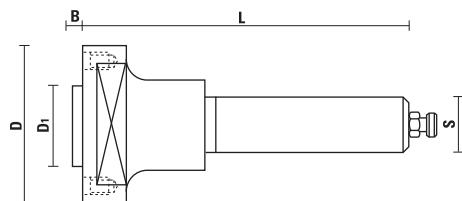
ADATTATORE PER SEGHE CIRCOLARI
ADAPTER FOR CIRCULAR SAWBLADES
ART. T128

- Nr. 4 fori a 90°
- Viene fornito completo di nr. 4 viti per il fissaggio della lama e vite di sicurezza
- **Si utilizza con nostro Art. XAH100 (Lamello®) e con seghe circolari di diametro fino a 200 mm**
- Gamma completa alla pagina 7.27 del nostro Catalogo 14.A

- Nr. 4 pin holes 90°
- Complete with nr. 4 screws to fix the sawblade
- **To be used with our item XAH100 (Lamello®) and with circular saw blades up to diameter 200 mm**
- Full range at page 7.27 of our Catalog 14.A

Articolo/Item	D	D1	B	S	L	Fori trasc./ Pin holes
T128.141.R NEW	60	22	2,5	Ø20x60	90	4/4/36
T128.145.R NEW	60	30	2,5	Ø25x60	90	4/6/48



Z051.014.R

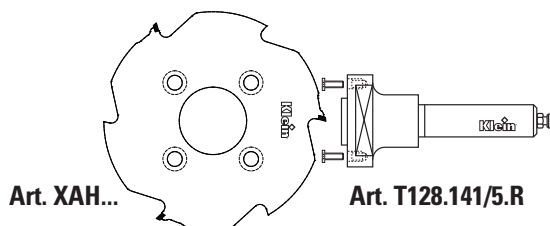
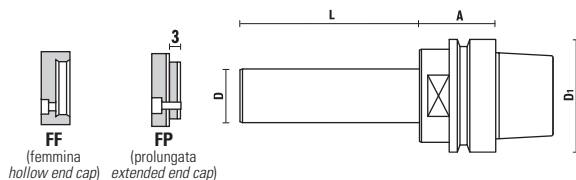

Z051.506.R

PORTAFRESE CONO HSK-63E
CUTTER ARBORS WITH HSK-63E TAPER
ART. T128

- Viene fornito completo di flangia di serraggio pag. 10.14
- Nr. 3 fori a 120°
- **Gamma completa alla pagina 7.29 del nostro Catalogo 14.A**

- Complete with end cap page 10.14
- Nr. 3 pin holes to 120°
- Full range at page 7.29 of our Catalog 14.A

Articolo/Item	Cono/Type	A	D	D1	L	Flangia di serraggio/End cap
T128.988.RM NEW	HSK-63E	42	30	63	100	FP - Z092.002.R
T128.988.R140M NEW	HSK-63E	42	30	63	140	FP - Z092.002.R
T128.988.R160M NEW	HSK-63E	42	30	63	160	FP - Z092.002.R
T128.988.R180M NEW	HSK-63E	42	30	63	180	FP - Z092.002.R
T128.988.R190M NEW	HSK-63E	42	30	63	190	FP - Z092.002.R
T128.988.R220M NEW	HSK-63E	42	30	63	220	FP - Z092.002.R
T128.988.R230M NEW	HSK-63E	42	30	63	230	FP - Z092.002.R
T128.988.35x100 NEW	HSK-63E	42	35	63	100	FF - Z092.003.R
T128.988.35x100M NEW	HSK-63E	42	35	63	100	FP - Z092.004.R
T128.988.35x130M NEW	HSK-63E	42	35	63	130	FP - Z092.004.R
T128.988.35x150M NEW	HSK-63E	42	35	63	150	FP - Z092.004.R
T128.988.35x180M NEW	HSK-63E	42	35	63	180	FP - Z092.004.R
T128.988.35x200M NEW	HSK-63E	42	35	63	200	FP - Z092.004.R
T128.988.40x100 NEW	HSK-63E	42	40	63	100	FF - Z092.005.R
T128.988.40x100M NEW	HSK-63E	42	40	63	100	FP - Z092.006.R
T128.988.40x150M NEW	HSK-63E	42	40	63	150	FP - Z092.006.R
T128.988.40x200M NEW	HSK-63E	42	40	63	200	FP - Z092.006.R

FRESE HW INTEGRALE ELICA DESTRA Z=2, RICOPERTE KleinDIA
SOLID CARBIDE SPIRAL CUTTERS FINISH STYLE Z=2, KleinDIA COATED

ART. T142.KD

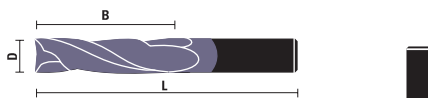

Migliore finitura
piano inferiore
Excellent finish
on bottom side



Ricoperte **KleinDIA**
per grandi prestazioni

KleinDIA coating for
excellent performance

- Rotazione destra con elica destra "TIPO TRAENTE"
- Tagliente lappato e ricoperto per un minore attrito e una migliore fuoriuscita del truciolo
- Elevatissima durata dell'utensile e migliori performance
- Per centri di lavoro, pantografi CNC e macchine punto a punto
- Per legni teneri e duri, pannelli truciolati, MDF, HF, lamellari, termoplastici, materiali minerali (CORIAN® ecc.)
- Right-hand rotation with "UP CUT SPIRAL"
- Polished and coated cutting edge for improved chip evacuation and less friction for excellent performance
- Longer tool life and greater cutting quality
- To be used on machining centres, CNC routers and point to point machines
- For softwood and hardwood, chipboard, MDF, HF, plywood, plastic coated, mineral materials (CORIAN® ecc.)

Rot. DX/Rh rot.	D	B	L	Z
T142.030.RKD NEW	3	12	50	2
T142.040.RKD NEW	4	12	50	2
T142.050.RKD NEW	5	17	50	2
T142.060.RKD NEW	6	17	60	2
T142.061.RKD NEW	6	27	60	2
T142.080.RKD NEW	8	22	80	2
T142.081.RKD NEW	8	35	80	2
T142.100.RKD NEW	10	35	80	2
T142.101.RKD NEW	10	45	100	2
T142.121.RKD NEW	12	45	100	2

FRESE HW INTEGRALE ELICA DESTRA Z=3, RICOPERTE KleinDIA
SOLID CARBIDE SPIRAL CUTTERS FINISH STYLE Z=3, KleinDIA COATED

ART. T143.KD

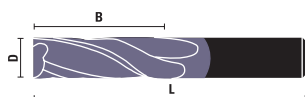

Migliore finitura
piano inferiore
Excellent finish
on bottom side



Ricoperte **KleinDIA**
per grandi prestazioni

KleinDIA coating for
excellent performance

- Rotazione destra con elica destra "TIPO TRAENTE"
- Tagliente lappato e ricoperto per un minore attrito e una migliore fuoriuscita del truciolo
- Elevatissima durata dell'utensile e migliori performance
- Per centri di lavoro, pantografi CNC e macchine punto a punto
- Per legni teneri e duri, pannelli truciolati, MDF, HF, lamellari, termoplastici, materiali minerali (CORIAN® ecc.)
- Right-hand rotation with "UP CUT SPIRAL"
- Polished and coated cutting edge for improved chip evacuation and less friction for excellent performance
- Longer tool life and greater cutting quality
- To be used on machining centres, CNC routers and point to point machines
- For softwood and hardwood, chipboard, MDF, HF, plywood, plastic coated, mineral materials (CORIAN® ecc.)

Rot. DX/Rh rot.	D	B	L	Z
T143.081.RKD NEW	8	35	80	3
T143.100.RKD NEW	10	35	80	3
T143.101.RKD NEW	10	45	100	3
T143.121.RKD NEW	12	45	100	3

FRESE HW INTEGRALE ELICA DESTRA Z=3 CON ROMPITRUCIOLO, RICOPERTE KleinDIA® SOLID CARBIDE SPIRAL CUTTERS ROUGHING STYLE Z=3, KleinDIA® COATED

ART. T144.KD

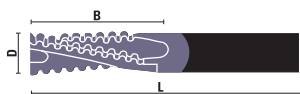

Ricoperte KleinDIA®
per grandi prestazioni

KleinDIA® coating for
excellent performance

- Rotazione destra con elica destra "TIPO TRAENTE"
- Tagliante lappato e ricoperto per un minore attrito e una migliore fuoriuscita del truciolo.
- Esecuzione con rompitruciolo
- Elevatissima durata dell'utensile e migliori performance
- Per centri di lavoro, pantografi CNC e macchine punto a punto
- Adatte alla sgrossatura, garantiscono una elevata velocità di avanzamento

- Right-hand rotation with "UP CUT SPIRAL"
- Polished and coated cutting edge for improved chip evacuation and less friction for excellent performance
- Chip-breaker execution
- Longer tool life and greater cutting quality
- To be used on machining centres, CNC routers and point to point machines
- Suitable for roughing, they guarantee a high feed rate

Rot. DX/Rh rot.	D	B	L	Z
T144.081.RKD NEW	8	35	80	3
T144.100.RKD NEW	10	35	80	3
T144.101.RKD NEW	10	45	100	3
T144.121.RKD NEW	12	45	100	3
T144.161.RKD NEW	16	55	100	3

FRESE HW INTEGRALE ELICA DESTRA CON DOPPIO CUSCINETTO Z=2 HW FLUSH TRIM BITS WITH DOUBLE BALL BEARINGS Z=2

ART. T168

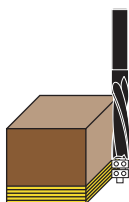

- Rotazione destra con elica destra "TIPO TRAENTE"
- Con doppio cuscinetto in testa per una maggiore precisione di rifilatura
- Permette una migliore evacuazione del truciolo in lavorazione grazie alla speciale geometria ad elica
- Per legno naturale, pressato, laminato e melaminico

- Right-hand rotation with "UP CUT SPIRAL"
- Double ball bearings guide for greater precision of trimming
- Special spiral geometry which provides better chip evacuation and smoother cuts compared to standard flush trim bits
- For natural wood, pressed wood, veneered, laminate and melamine

Rot. DX/Rh rot.	D	B	L	Z	S
T168.127.R NEW	12,7	51	125	2	12



Z050.007.N



FRESE HW INTEGRALE A COMPRESSIONE Z=3+3 SOLID CARBIDE COMPRESSION CUTTERS Z=3+3

ART. T356

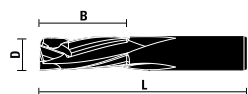

Migliore finitura
su entrambi i piani
Excellent finish on both
upper and lower side

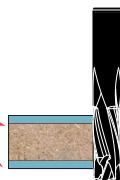

- Rotazione destra
- Per centri di lavoro, pantografi CNC e macchine punto a punto
- **Ottima finitura del pannello su entrambi i piani**
- Per legni teneri e duri, pannelli truciolati, MDF, HF, lamellari, termoplastici, materiali minerali (CORIAN® ecc.)

- Right-hand rotation
- To be used on machining centres, CNC routers and point to point machines
- **Excellent finish on both upper and lower side of the panel**
- For softwood and hardwood, chipboard, MDF, HF, plywood, plastic coated, mineral materials (CORIAN® ecc.)

Rot. DX/Rh rot.	D	B	L	Z
T356.080.R	8	22	70	3+3
T356.100.R	10	22	70	3+3
T356.101.R	10	32	70	3+3
T356.120.R	12	32	80	3+3
T356.121.R	12	42	100	3+3
T356.160.R	16	42	100	3+3
T356.161.R	16	52	100	3+3

FRESE HW INTEGRALE PER SERRATURE Z=3, RICOPERTE KleinDIA SOLID CARBIDE SPIRAL CUTTERS FOR LOCK-CASE Z=3, KleinDIA COATED

ART. T357.KD

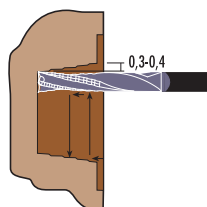
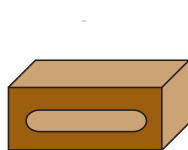
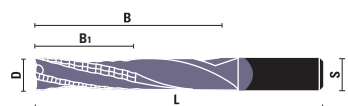

Ricoperte KleinDIA
per grandi prestazioni

KleinDIA coating for
excellent performance

- Rotazione destra con elica destra "TIPO TRAENTE"
- Esecuzione con rompitruciolo semifinitore (come ns. Artt. T344 - T354 vedi pag. 7.50 del nostro Catalogo 14.A)
- Per realizzare sedi per serrature e cerniere
- **Tagliante lappato e ricoperto per un minore attrito e una migliore fuoriuscita del truciolo. Elevate prestazioni.**
- Per centri di lavoro, pantografi CNC e macchine punto a punto
- Per legni teneri e duri, pannelli truciolati, MDF, HF, lamellari, termoplastici, materiali minerali (CORIAN® ecc.)

- Right-hand rotation with "UP CUT SPIRAL"
- **Semifinished chip-breaker execution (roughing and finishing) as our items T344 - T354 at page 7.50 of our Catalog 14.A**
- For locks and slot mortising
- **Polished and coated cutting edge for improved chip evacuation and less friction for excellent performance**
- To be used on machining centres, CNC routers and point to point machines
- For softwood and hardwood, chipboard, MDF, HF, plywood, plastic coated, mineral materials (CORIAN® ecc.)

ESEMPIO DI UTILIZZO

- Lavorazione a gradini 0,3-0,4 mm
- Grande profondità di fresata con ottima capacità di scarico

USE EXAMPLE

- Stepwise processing 0,3-0,4 mm
- Can work deeply and have excellent chip evacuation

Rot. DX/Rh rot.	D	B1	B	L	S	Z
T357.162.RKD NEW	16	45	100	150	16x45	3

GHIERA CONVOGLIATORE DUST & CHIP EXTRACTION NUT

ART. T139



Tornado®

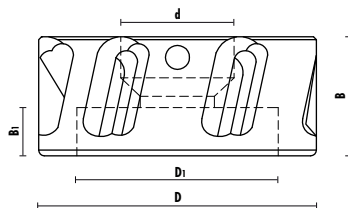

- Costruito in lega leggera (alluminio)
- Trattamento di indurimento superficiale
- **Adatto per tutti i tipi di cono** (HSK, ISO, BT, ..)
- Diametro utensile max: $\varnothing 98=70$ mm - $\varnothing 80=60$ mm
- Velocità di rotazione massima 20.000 RPM
- Bilanciatura G 2,5
- Peso 0,4 kg
- In scatola di cartone

Watch the Video on



- Tool body in light alloy
- Surface hardening treatment
- **Suitable for every type of collet chuck** (HSK, ISO, BT, ...)
- Maximum tool diameter: $\varnothing 98=70$ mm - $\varnothing 80=60$ mm
- Maximum speed rotation at 20.000 RPM
- Balanced at G2,5
- Weight 0,4 kg
- Single packed in carton box

Articolo/Item	Tipo/Type	D	D1	B	B1	d	Rot.
T139.501.R	DIN6499 (ER32)	98	74	42	17	M 40x1,5	Dx/Rh
T139.502.R	DIN6499 (ER40)	98	74	42	17	M 50x1,5	Dx/Rh
T139.503.R	DIN6499 (ER25)	98	74	42	17	M 32x1,5	Dx/Rh
T139.522.R	DIN6388 (EOC25)	98	74	42	17	M 48x2	Dx/Rh
T139.581.R	DIN6499 (ER32)	80	64	42	13	M 40x1,5	Dx/Rh

KIT GHIERA CONVOGLIATORE DUST & CHIP EXTRACTION NUT SET

ART. X139



- Kit composta da:
nr. 1 ghiera convogliatore
nr. 1 chiave a settore:
 $\varnothing 98=$ ch. 95/100
 $\varnothing 80=$ ch. 80/90
- Scatola in cartone
- Complete with:
n° 1 extraction nut
n° 1 wrench:
 $\varnothing 98=$ key 95/100
 $\varnothing 80=$ key 80/90
- Carton box

Articolo/Item	Descrizione/Description	Tipo/Type
X139.501.R	T139.501.R + Z052.315.N	DIN6499 (ER32)
X139.502.R	T139.502.R + Z052.315.N	DIN6499 (ER40)
X139.503.R	T139.503.R + Z052.315.N	DIN6499 (ER25)
X139.522.R	T139.522.R + Z052.315.N	DIN6388 (EOC25)
X139.581.R	T139.581.R + Z052.314.N	DIN6499 (ER32)

KIT GHIERA CONVOGLIATORE DUST & CHIP EXTRACTION NUT SET

ART. X139



- Kit composta da:
nr. 2 ghiera (ER32 - ER40)
nr. 1 chiave a settore 95/100
- Scatola in cartone
- Complete with:
n° 2 extraction nuts
(ER32 - ER40)
n° 1 wrench 95/100
- Carton box

Articolo/Item	Descrizione/Description
X139.990.R	T139.501.R + T139.502.R + Z052.315.N

Tornado: la nuova soluzione della Sistemi che favorisce l'aspirazione di polveri e trucioli durante la lavorazione di nesting e pantografatura. Facile da montare direttamente sul cono al posto della ghiera standard, permette di risolvere il problema delle polveri convogliandole con facilità verso il sistema d'aspirazione centralizzato delle macchine CNC.

Tornado: the new conveyor clamping nut helps both dust and chip evacuation during Nesting and conventional CNC Routing operations. Easy to assemble directly on the collet chuck instead of the standard nut, the new Klein Tornado provides a big improvement of dust evacuation, removing it from the workpiece directly into the centralized extraction system of the CNC machines.

FACILE DA MONTARE COME UNA GHIERA STANDARD/ EASY TO MOUNT LIKE A STANDARD CLAMPING NUT

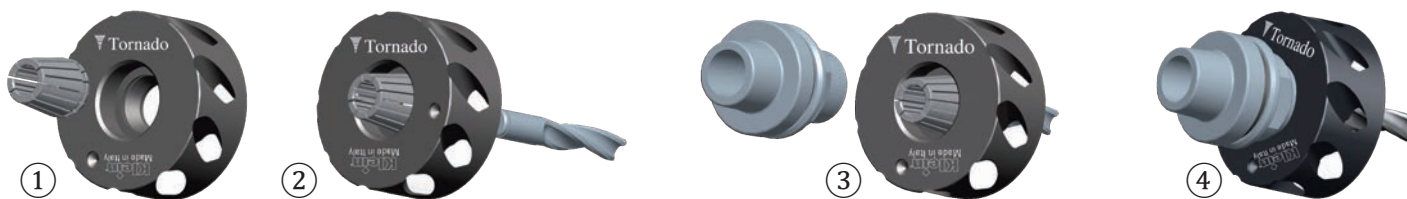

LAVORAZIONE CON TORNADO/ WORKING WITH TORNADO



LAVORAZIONE SENZA TORNADO/ WORKING WITHOUT TORNADO



**FRESE HW INTEGRALE ELICA DESTRA Z=5 PER SUPERFINITURA
SOLID CARBIDE SPIRAL CUTTERS Z=5 SUPER-FINISHING**

ART. U115

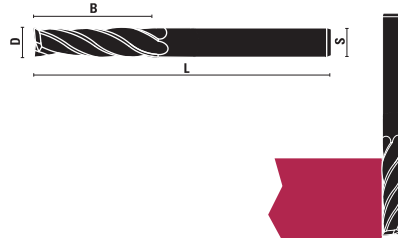

- Per lavorazione di plexiglass e acrilici
- Rotazione destra con elica destra "TIPO TRAENTE"
- Tagliente lappato per un minore attrito e una migliore fuoriuscita del truciolo
- Per centri di lavoro e pantografi C.N.C.
- Ideale per lucidatura e migliore finitura superficiale

- For working plexiglass and acrylic
- Right-hand rotation with "UP CUT SPIRAL"
- Polished cutting edge for improved chip evacuation and less friction
- To be used on machining centres and CNC routers
- Especially made for plexiglass polishing and best finishing cuts

Rot. DX/Rh Rot.	D	B	L	S
U115.060.R NEW	6	25	70	6
U115.080.R NEW	8	30	80	8
U115.100.R NEW	10	35	80	10

**FRESE HW INTEGRALE ELICA DESTRA Z=5 PER SUPERFINITURA, RICOPERTE KleinDIA[®]
SOLID CARBIDE SPIRAL CUTTERS Z=5 SUPER-FINISHING KleinDIA[®] COATED**

ART. U115.KD

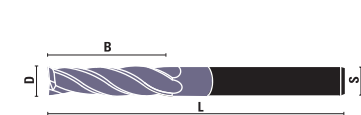

- Tagliente lappato e ricoperto per un minore attrito e una migliore fuoriuscita del truciolo. Elevate prestazioni.

- Polished and coated cutting edge for improved chip evacuation and less friction for excellent performance

 Ricoperte **KleinDIA[®]**
per grandi prestazioni

KleinDIA[®] coating for
excellent performance

Rot. DX/Rh Rot.	D	B	L	S
U115.060.RKD NEW	6	25	70	6
U115.080.RKD NEW	8	30	80	8
U115.100.RKD NEW	10	35	80	10

**FRESE IN HW INTEGRALE PER VETRORESINA, RICOPERTE KleinDIA[®]
SOLID CARBIDE BITS FOR FIBERGLASS WORKING, KleinDIA[®] COATED**

ART. U130.KD

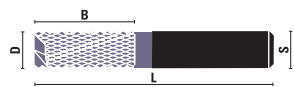

- Per lavorazione di materie plastiche, gomma dura e fibra di vetro
- Rotazione destra
- Per contornare e rasare frontale
- Da utilizzare su fresatrici, pantografi CNC e macchine portatili

- For working plastic materials, rubber and fiberglass

- Right-hand rotation
- For routing and shearing
- To be used on portable machines, CNC and routing machines

 Ricoperte **KleinDIA[®]**
per grandi prestazioni

KleinDIA[®] coating for
excellent performance

Articolo/Item	D	B	L	S	Rot.
U130.030.RKD	3	12	38	3	Dx/Rh
U130.040.RKD	4	15	40	4	Dx/Rh
U130.050.RKD	5	18	50	5	Dx/Rh
U130.060.RKD	6	22	55	6	Dx/Rh
U130.080.RKD	8	30	70	8	Dx/Rh
U130.100.RKD	10	30	72	10	Dx/Rh
U130.120.RKD	12	30	73	12	Dx/Rh

è oggi il trattamento superficiale più vantaggioso considerato che offre:

- **Maggior produzione**
(3/4 volte in più dell'utensile non ricoperto)
- **Miglior finitura**
- **Minor manutenzione**
(tempo risparmiato per il cambio utensile e minori affilature)

 Consigliato nelle lavorazioni di:
di legno massello, lamellari, materiali plastici,
materiali grafici, plexiglass, vetroresina e metalli leggeri.

KleinDIA[®]

is the most advantageous coating, ensuring:

- **Production increase**
(3/4 times more productive than an uncoated tool)
- **Better finishing**
- **Less maintenance** (no more wasted time for changing tools and less grinding operations)

 Excellent results can be achieved processing:
solid wood, plywood, Plexiglas, plastic and
graphitic materials, rubber and fiberglass.

FRESE HS-E ELICOIDALI PER ALLUMINIO Z=1, RICOPERTE KleinDIA[®] HS UPCUT SPIRAL BITS FOR ALUMINIUM Z=1, KleinDIA[®] COATED

ART. U201.KD

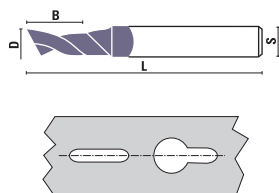

Ricoperte KleinDIA[®]
per grandi prestazioni

KleinDIA[®] coating for
excellent performance

- Costruite con acciaio HS al 5% cobalto
- Tagliente lappato per un minore attrito e una migliore fuoriuscita del truciolo
- Da usare su profilati in alluminio
- Per forare e contornare
- Usare con lubrificante

- Manufactured in HS 5% cobalt
- Polished cutting edge for improved chip evacuation and less friction
- Used for alu profiles
- Plunging and routing
- Use with lubricant

Rot. DX/Rh rot.	D	B	L	S
U201.040.RKD NEW	4	12	60	8
U201.050.RKD NEW	5	14	70	8
U201.060.RKD NEW	6	14	70	8
U201.080.RKD NEW	8	14	70	8
U201.081.RKD NEW	8	30	100	8
U201.100.RKD NEW	10	14	80	8

FRESE HS-E ELICOIDALI PER ALLUMINIO Z=1 TIPO LUNGO, RICOPERTE KleinDIA[®] HS UPCUT SPIRAL BITS FOR ALUMINIUM Z=1 LONG TYPE, KleinDIA[®] COATED

ART. U202.KD

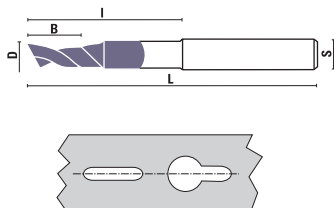

Ricoperte KleinDIA[®]
per grandi prestazioni

KleinDIA[®] coating for
excellent performance

- Costruite con acciaio HS al 5% cobalto
- Tagliente lappato per un minore attrito e una migliore fuoriuscita del truciolo
- Da usare su profilati in alluminio
- Per forare e contornare
- Con stelo ridotto
- Usare con lubrificante

- Manufactured in HS 5% cobalt
- Polished cutting edge for improved chip evacuation and less friction
- Used for alu profiles
- Plunging and routing
- Reduced throat execution
- Use with lubricant

Rot. DX/Rh rot.	D	B/l	L	S
U202.050.RKD NEW	5	14/35	80	8
U202.080.RKD NEW	8	14/60	80	8
U202.083.RKD NEW	8	30/70	100	8
U202.102.RKD NEW	10	14/95	120	8

FRESE HW INTEGRALE ELICA DESTRA Z=2 TIPO, RICOPERTE KleinDIA[®] SOLID CARBIDE SPIRAL CUTTERS Z=2, KleinDIA[®] COATED

ART. U302.KD

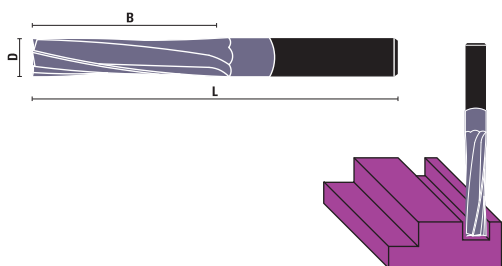

Ricoperte KleinDIA[®]
per grandi prestazioni

KleinDIA[®] coating for
excellent performance

- Per lavorazione di materiali compositi (Corian[®] - Avonite[®])
- Rotazione destra con elica destra "TIPO TRAENTE"
- Tagliente lappato per un minore attrito e una migliore fuoriuscita del truciolo in lavorazione consentendo una migliore resa e maggiore durata dell'utensile
- Inclinazione dell'elica specifica per lavorare materiali compositi
- Utilizzo di widia specifico per una migliore qualità di taglio

- For working Solid Surface (Corian[®] - Avonite[®])
- Right-hand rotation with "UP CUT SPIRAL"
- Polished cutting edge for improved chip evacuation and less friction by allowing better quality cuts and longer tool life
- Special shear angle for working solid surface without breakage
- Specific solid carbide for best cutting quality

Rot. DX/Rh Rot.	D	B	L
U302.080.RKD NEW	8	32	80
U302.100.RKD NEW	10	42	100
U302.120.RKD NEW	12	42	100
U302.160.RKD NEW	16	62	120

FRESE CON COLTELLINI HW PER REFILARE CON DOPPIO CUSCINETTO INFERIORE Z=2 HW INSERT FLUSH TRIMMING BITS WITH LOWER DOUBLE BALL BEARINGS Z=2

ART. W114

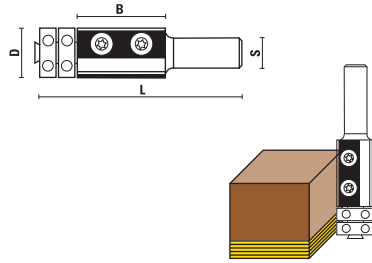

- Doppio cuscinetto inferiore per una maggiore precisione di rifilatura
- Gamma completa alla pagina 9.06 del nostro Catalogo 14.A

- Double ball bearings for more precise trimming results
- Full range at page 9.06 of our Catalog 14.A

Articolo/Item	D	B	L	Z	S
W114.192.R NEW	19	50	100	2	12



Z050.006.N



Z052.201.N



Z055.010.N



Z051.010.R

FRESE CON COLTELLINI HW PER REFILARE CON DOPPIO CUSCINETTO SUPERIORE Z=2 HW INSERT FLUSH TRIMMING BITS WITH UPPER DOUBLE BALL BEARINGS Z=2

ART. W116

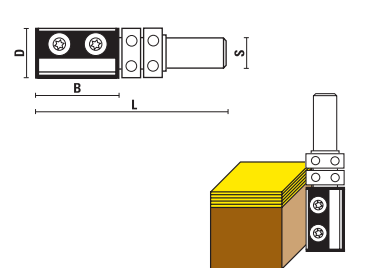

- Doppio cuscinetto superiore per una maggiore precisione di rifilatura
- Gamma completa alla pagina 9.06 del nostro Catalogo 14.A

- Double ball bearings for more precise trimming results
- Full range at page 9.06 of our Catalog 14.A

Articolo/Item	D	B	L	Z	S
W116.192.R NEW	19	50	100	2	12



Z050.012.N



Z052.201.N



Z055.010.N



Z051.010.R

FRESE CON COLTELLINI HW PER SPIANARE Z=3 HW INSERT ROUTER BITS FOR PLANING AND RABBETING Z=3

ART. W190

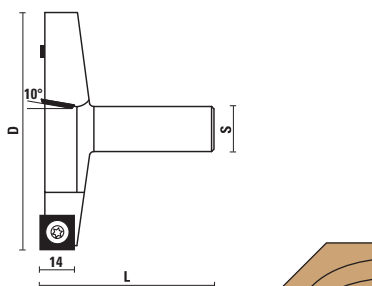

Angolo di taglio 10°/10° shear angle

- Particolarmente indicato per spianare larghe superfici di MDF o produrre profondi scalini in una singola passata
- Angolo di taglio 10°
- Adatte per ogni tipo di legno
- Si usa su pantografi e su centri di lavoro CNC
- Rotazione destra

- Used for surfacing MDF and particle board and making deep rabbet
- 10° shear angle
- Suitable for processing ever kind of wood
- To be used on machining centres and CNC routers
- Right-hand rotation

Articolo/Item	D	B	L	Z	S
W190.100.R NEW	100	14	80	3	∅20x55
W190.101.R NEW	101,6(4")	14	76	3	∅19,05x55 (3/4")
WE190.800.R NEW	80	14	76	3	∅12x50



Z051.201.R



Z055.007.N



Z052.201.N

FRESE CON COLTELLINI HW PER SCANALATURE Z=2 HW INSERT RABBETING BITS Z=2

ART. WE150

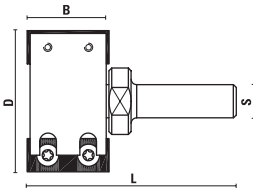

- Per l'utilizzo su portamodulo **FESTOOL® CMS-OF 1010/ BASIS 5A/BASIS 6**
- Da utilizzare su sistema **FESTOOL®** per lavori semistazionari su unità di base CMS (Compact Modular System)
- Suitable for **working with FESTOOL® CMS-OF 1010/ BASIS 5A/BASIS 6**
- To be used with **FESTOOL® Compact Modular System (CMS)**

Articolo/Item	D	B	L	Z	S
WE150.500.R NEW	50	30	70	2	Ø12

RICAMBI/ SPARE PARTS

Fresa/ Rabbeting head

WE150.505.R NEW	Ø50x30	Foro/ Bore Ø12	Z=2
------------------------	--------	----------------	-----

Alberino portafresa/ Cutter arbor

E117.130.N NEW	S= Ø12x36
-----------------------	-----------



Z051.010.R



Z052.201.N



Z055.110.N

MONTAGGIO/ ASSEMBLY

WE150.505.R
Fresa
Rabbeting head



+

E117.130.R
Alberino
Cutter arbor



=

WE150.500.R



FRESE PKD PER CONTORNARE CON ANGOLO ASSIALE 40° DP ROUTER CUTTERS WITH 40° SHEAR ANGLE

ART. X520 - X521

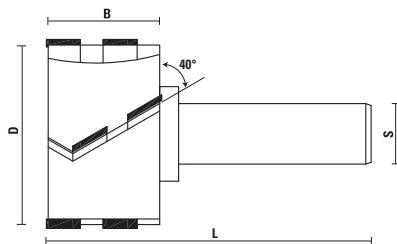

- **Angolo assiale 40°**
- Ideale per la contornatura di legno duro, MDF, impiallacciato, nobilitato e HPL
- Si usano su centri di lavoro e pantografi CNC
- Altezza placchetta PKD = 4mm (fino a 10 riaffilature)
- **40° shear angle**
- Recommended for routing and trimming solid hardwood, MDF, veneered, melamine and HPL panels
- To be used on machining centres and CNC routers
- DP tip height 4 mm (up to 10 times regrindable)

Rot. Dx/ Rh Rot.	D	B	L	S	Z	Placchette/Tips
X520.501.R NEW	50	23	80	20x55	3+3	9
X520.502.R NEW	50	23	80	20x55	4+4	12
X520.511.R NEW	50	28	80	20x55	3+3	15
X520.512.R NEW	50	28	80	20x55	4+4	20
X520.521.R NEW	50	38	80	20x55	3+3	21
X520.522.R NEW	50	38	80	20x55	4+4	28
X521.501.R NEW	50	23	80	25x55	3+3	9
X521.502.R NEW	50	23	80	25x55	4+4	12
X521.511.R NEW	50	28	80	25x55	3+3	15
X521.512.R NEW	50	28	80	25x55	4+4	20
X521.521.R NEW	50	38	80	25x55	3+3	21
X521.522.R NEW	50	38	80	25x55	4+4	28

FRESE PKD TIPO USA E GETTA H=1,5 DP ROUTER BITS H=1,5

ART. X522 - X523

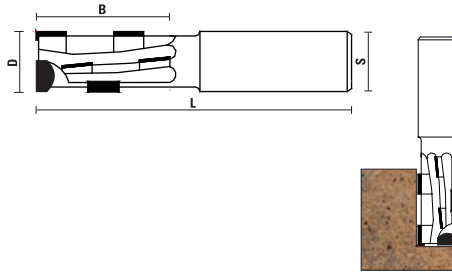

- Altezza placchetta PKD = 1,5 mm
- Ideale per la foratura e contornatura di legno duro massello, MDF impiallacciato e nobilitato
- **Tagliante per forare in HW**
- Da utilizzare su centri di lavoro e pantografi CNC
- **DP tip height 1,5 mm**
- Recommended for grooving and routing solid hardwood, veneered and laminated MDF
- **HW plunging tip**
- To be used on CNC router machines

Rot. Dx/Rh Rot.	Rot. Sx/Lh Rot.	D	B	L	S	Z	Placchette/Tips
X522.180.R	X522.180.L	18	25	85	20x50	3	3+1
X522.181.R	X522.181.L	18	36	96	20x50	3	4+1
X522.182.R	X522.182.L	18	45	105	20x50	3	5+1
X522.200.R	X522.200.L	20	25	85	20x50	3	3+1
X522.201.R	X522.201.L	20	36	96	20x50	3	4+1
X522.202.R	X522.202.L	20	45	105	20x50	3	5+1
X522.203.R	X522.203.L	20	53	113	20x50	3	6+1
X523.200.R	X523.200.L	20	25	90	25x55	3	3+1
X523.201.R	X523.201.L	20	36	100	25x55	3	4+1
X523.202.R	X523.202.L	20	45	110	25x55	3	5+1
X523.203.R	X523.203.L	20	53	118	25x55	3	6+1
X523.250.R	X523.250.L	25	36	100	25x55	3	4+1
X523.251.R	X523.251.L	25	45	110	25x55	3	5+1
X523.252.R	X523.252.L	25	53	118	25x55	3	6+1
X523.253.R	X523.253.L	25	62	127	25x55	3	7+1

FRESE PKD PER LAVORAZIONE NESTING DP ROUTER BITS FOR NESTING OPERATION

ART. X528

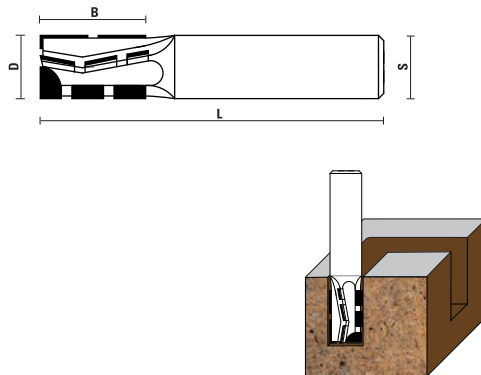

- Altezza placchetta PKD = 3 mm (3 affilature)
- Corpo fresa costruito con acciaio ad alta resistenza (**Densimet®**)
- Ideale per **lavorazione Nesting** di pannelli in truciolare, compensato, impiallacciato e MDF
- **Tagliante per forare in PKD**
- Avanzamento 26 m/min⁻¹
- Da utilizzare su centri di lavoro e pantografi CNC
- È consigliabile l'utilizzo insieme alla ghiera "**Tornado®**" Art. T139
- **DP tip height 3 mm (3 times regrindable)**
- Sturdy tool body in high density metal (**Densimet®**)
- Recommended for **Nesting operations** on chipboard, veneered and laminated MDF
- **DP plunging tip**
- To be used on CNC router machines
- For improved dust extraction use together with our Art. T139 "**Tornado®**" chip & dust conveyor clamping nut

Articolo/Item	D	B	L	S	Z	Placchette/Tips	Rot.
X528.120.R	12	20	70	12x45	3	8	Dx/Rh
X528.121.R	12	25	75	12x45	3	10	Dx/Rh
X528.122.R	12	30	80	12x45	3	12	Dx/Rh
X528.123.R	12	35	85	12x45	3	14	Dx/Rh

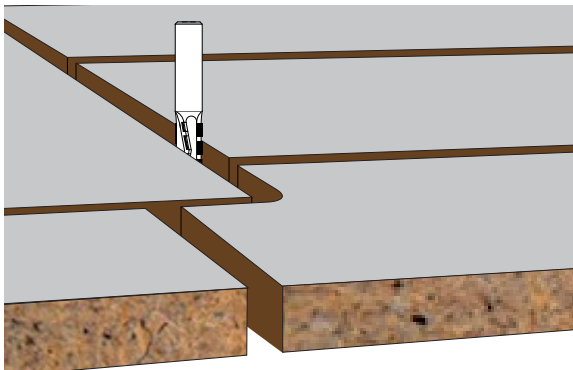

GHIERE ECCENTRICHE
CLAMPING NUT WITH ECCENTRIC RING

ART. Z091

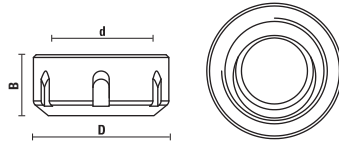

- Ideale per l'utilizzo con pinze a tenuta stagna Artt. T119/T123 NTS a pag. 7.21 e coni inox a pag. 7.18 del Catalogo 14.A
- **Per lavorazioni con l'uso di refrigerante**
- *To be used with our water-tight collets (Items T119/T123 NTS) at page 7.21 and stainless steel collet chucks at page 7.18 of our Catalog 14.A*
- **Suitable when working with coolant**

Articolo/Item	Tipo/Type	D	B	d	Rot.
Z091.051.R NEW	DIN 6499 (ER 32)	50	23	M 40x1,5	Dx/Rh
Z091.052.R NEW	DIN 6499 (ER 40)	63	25	M 50x1,5	Dx/Rh

GRUPPO/SECTION 11
COLTELLINI REVERSIBILI PKD
DP STANDARD REVERSIBLE KNIVES

ART. XZ055

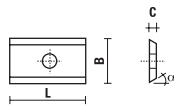
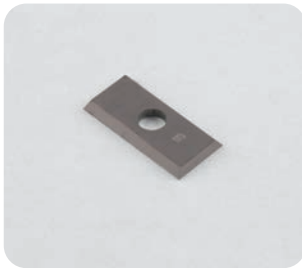

 VENDUTI SINGOLARMENTE
 SOLD INDIVIDUALLY

- Questo coltellino sostituisce perfettamente quello in HW tradizionale
- **2 Taglienti**
- La durata è maggiore di circa 35/50 volte rispetto alla versione in HC05
- Con 1 foro di fissaggio
- Coltellino riaffilabile
- **ATTENZIONE:** se si affila un coltellino su frese multitagliente assicurarsi di avere tutti i coltellini alla stessa altezza
- *These knives replace perfectly the HW standard knives*
- **2 cutting edges**
- *Lifetime up to 35/50 times longer compared to the HC05 (HW) knives*
- 1 fixing hole
- Regrindable knives
- **CAUTION:** when sharpening a multicutter bit make sure that all the knives are mounted at the same height

Articolo/Item	L	B	C	α
XZ055.000.N NEW	7,5	12	1,5	35°
XZ055.012.N NEW	9,6	12	1,5	35°
XZ055.002.N NEW	15	12	1,5	35°
XZ055.003.N NEW	20	12	1,5	35°
XZ055.014.N NEW	25	12	1,5	35°

COLTELLINI REVERSIBILI PKD
DP STANDARD REVERSIBLE KNIVES

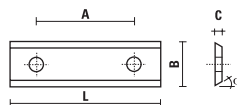
ART. XZ055



 VENDUTI SINGOLARMENTE
 SOLD INDIVIDUALLY

- Questo coltellino sostituisce perfettamente quello in HW tradizionale
- **2 Taglienti**
- La durata è maggiore di circa 35/50 volte rispetto alla versione in HC05
- Con 2 fori di fissaggio
- Coltellino riaffilabile
- **ATTENZIONE:** se si affila un coltellino su frese multitagliente assicurarsi di avere tutti i coltellini alla stessa altezza
- *These knives replace perfectly the HW standard knives*
- **2 cutting edges**
- *Lifetime up to 35/50 times longer compared to the HC05 (HW) knives*
- 2 fixing holes
- Regrindable knives
- **CAUTION:** when sharpening a multicutter bit make sure that all the knives are mounted at the same height

Articolo/Item	L	B	C	α	A
XZ055.008.N NEW	30	12	1,5	35°	14
XZ055.009.N NEW	40	12	1,5	35°	26
XZ055.010.N NEW	50	12	1,5	35°	26
XZ055.011.N NEW	60	12	1,5	35°	26

COLTELLINI REVERSIBILI PKD A 4 TAGLIENTI
DP STANDARD REVERSIBLE KNIVES WITH 4 CUTTING EDGES

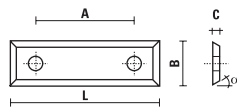
ART. XZ055



 VENDUTI SINGOLARMENTE
 SOLD INDIVIDUALLY

- Questo coltellino sostituisce perfettamente quello in HW tradizionale
- **4 Taglienti**
- La durata è maggiore di circa 35/50 volte rispetto alla versione in HC05
- Con 2 fori di fissaggio
- Coltellino riaffilabile
- **ATTENZIONE:** se si affila un coltellino su frese multitagliante assicurarsi di avere tutti i coltellini alla stessa altezza
- *These knives replace perfectly the HW standard knives*
- **4 cutting edges**
- *Lifetime up to 35/50 times longer compared to the HC05 (HW) knives*
- *2 fixing holes*
- *Regrindeable knives*
- **CAUTION:** when sharpening a multicutter bit make sure that all the knives are mounted at the same height

Articolo/Item	L	B	C	α	A
XZ055.329.N NEW	29,5	12	1,5	35°	14
XZ055.340.N NEW	39,5	12	1,5	35°	26
XZ055.349.N NEW	49,5	12	1,5	35°	26

COLTELLINI REVERSIBILI PKD A 4 TAGLIENTI 5° INCLINAZIONE DESTRA
DP 5° INCLINED REVERSIBLE KNIVES WITH 4 CUTTING EDGES

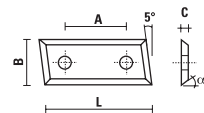
ART. XZ055



 VENDUTI SINGOLARMENTE
 SOLD INDIVIDUALLY

- Questo coltellino sostituisce perfettamente quello in HW tradizionale
- **4 Taglienti**
- La durata è maggiore di circa 35/50 volte rispetto alla versione in HC05
- **Inclinazione 5° a destra**
- Con 2 fori di fissaggio
- Coltellino riaffilabile
- **ATTENZIONE:** se si affila un coltellino su frese multitagliante assicurarsi di avere tutti i coltellini alla stessa altezza
- *These knives replace perfectly the HW standard knives*
- **4 cutting edges**
- *Lifetime up to 35/50 times longer compared to the HC05 (HW) knives*
- **5° right-hand inclination**
- *2 fixing holes*
- *Regrindeable knives*
- **CAUTION:** when sharpening a multicutter bit make sure that all the knives are mounted at the same height

Articolo/Item	L	B	C	α	A
XZ055.430.N NEW	29,5	12	1,5	35°	14
XZ055.440.N NEW	39,5	12	1,5	35°	26
XZ055.450.N NEW	49,5	12	1,5	35°	26

COLTELLINI REVERSIBILI PKD A 4 TAGLIENTI
DP STANDARD REVERSIBLE KNIVES

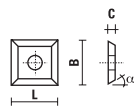
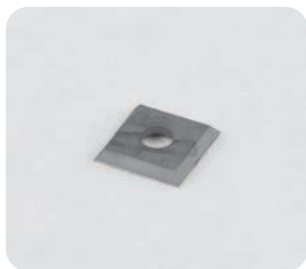
ART. XZ055



 VENDUTI SINGOLARMENTE
 SOLD INDIVIDUALLY

- **4 Taglienti**
- La durata è maggiore di circa 35/50 volte rispetto alla versione in HC05
- Con 1 foro di fissaggio
- Coltellino riaffilabile
- **ATTENZIONE:** se si affila un coltellino su frese multitagliante assicurarsi di avere tutti i coltellini alla stessa altezza
- **4 cutting edges**
- *Lifetime up to 35/50 times longer compared to the HC05 (HW) knives*
- *1 fixing hole*
- *Regrindeable knives*
- **CAUTION:** when sharpening a multicutter bit make sure that all the knives are mounted at the same height

Articolo/Item	L	B	C	α
XZ055.001.N NEW	12	12	1,5	35°

LAME CIRCOLARI IN PKD PER TAGLIO MATERIALI ABRASIVI DP SAW BLADES FOR CUTTING ABRASIVE MATERIALS

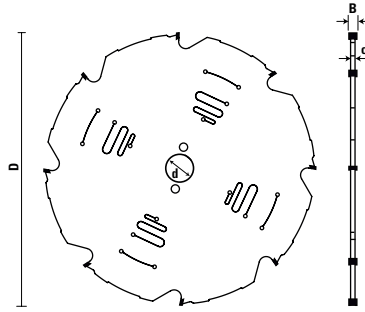
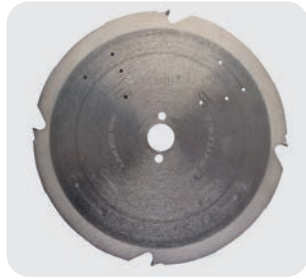
ART. XGE



- Ideale per il taglio della fibra cemento, materie plastiche rinforzate, cartongesso, superfici solide ed Eternit
- Dente piatto PKD
- Altezza placchetta PKD = 3,5 mm

- Suitable for cutting cement fiber, plasterboards, fiber reinforced plastics, solid surface and Eternit
- DP flat teeth
- DP tooth height 3,5 mm

Schema fori di trascimento/ Pin holes:
PH02= 2/7/42 + 2/9,5/46,5 + 2/10/60

Articolo/Item	D	d	B/c	Z	Fori trasc./Pin holes
XGE160.10420	160	20	2,4/1,6	4	2/6/32
XGE160.10820	160	20	2,4/1,6	8	2/6/32
XGE190.10420	190	20	2,4/1,6	4	2/6/32
XGE200.10430	200	30	2,4/1,6	4	2/7/42
XGE200.10830	200	30	2,4/1,6	8	2/7/42
XGE216.10830	216	30	2,4/1,6	8	-
XGE230.10630	230	30	2,4/1,6	6	2/7/42
XGE250.10630	250	30	2,4/1,6	6	PH02
XGE250.11230	250	30	2,4/1,6	12	PH02
XGE300.11230	300	30	2,4/1,6	12	PH02
XGE300.12030	300	30	2,4/1,6	20	PH02

LAME CIRCOLARI IN PKD PER INCASTRI "LAMELLO®" DP GROOVE CUTTER FOR "LAMELLO®" JOINTS

ART. XAH

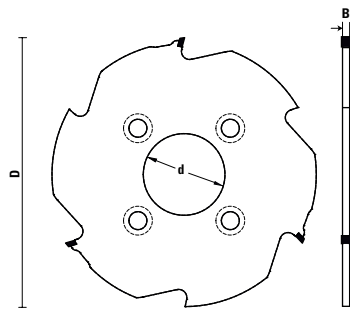

- Adatte per effettuare giunzioni Clamex P smontabili per mobili, scaffalature, armadi a muro, mensole
- Da utilizzare sia su macchine CNC che su fresatrici manuali ZETA P2
- Raccomandato per giunzioni longitudinali e ad angolo su legno massello, MDF impiallacciato e nobilitato con tecnologia P-System

- Suitable for making Clamex P connecting fittings for furniture, shelve units and kitchen making
- To be used both on CNC machines and ZETA P2 hand power tool
- Recommended for grooving corner and longitudinal joints on hardwood, veneered and laminated MDF with the P-System anchorage

Articolo/Item	D	d	B	Z	Fori trasc./Pin holes
XAH100.10330	100,4	30	7	3	4/6,6/48
XAH100.10630	100,4	30	7	6	4/6,6/48
XAH100.10322	100,4	22	7	3	4/4/36

GIUNZIONI CLAMEX P CLAMEX P JOINTS



SISTEMA DI ANCORAGGIO P-SYSTEM P-SYSTEM ANCHORAGE

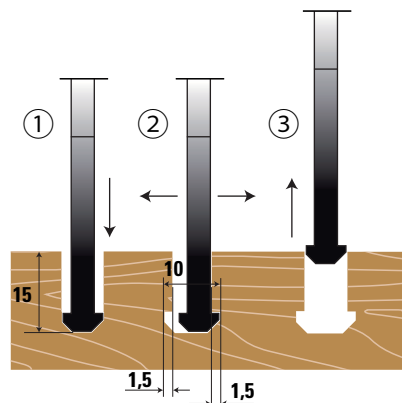

SET PER MACCHINE CNC TOOL SET FOR CNC

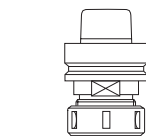

Art. T118...

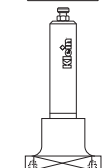

Art. T128.140.R
T128.141.R
T128.145.R

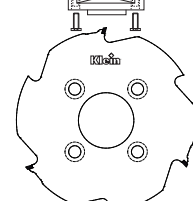

Art. XAH...

LAME CIRCOLARI DI PRECISIONE HW "EXTRA CUT" HW TRIMMING AND SIZING SAWBLADES "EXTRA CUT"

ART. FCT

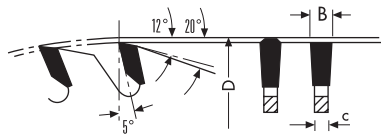

Xtra® cut



- Dente piatto trapezoidale (FZ/TR)
- Per taglio di pannelli **impiallacciati e laminati su due lati, MDF, truciolari a pacco** e pannelli con rivestimento plastico
- Ideale per lavorazioni **ALUCOBOND®**
- Si usano su seghe da banco
- Buona finitura, lunga durata di taglio
- **♫ = silenziose, antisibilo con speciale resina inserita nei tagli di silenziatura per una maggiore stabilità e notevole riduzione delle vibrazioni in fase di lavoro**
- **Qualità HW: KCR06 (K01-C4)**

Schema fori di trascinamento : PH02= 2/7/42 + 2/9,5/46,5 + 2/10/60

- **FZ/TR triple chip teeth trapezoidal**
- For cutting **hardwoods, double sided veneer and laminate board, MDF, hard paper and thermoplastic boards**
- Ideal for working **ALUCOBOND®**
- For table saws
- Extra finish and long cutting life
- **♫ = no-noise and less vibration thanks to a special synthetic resin filled in the slots to increase the stability and reduce vibrations**
- **HW grade: KCR06 (K01-C4)**

Pin holes: PH02=2/7/42 + 2/9,5/46,5 + 2/10/60

Articolo/Item	D	d	B/c	Z	Fori trasc./Pin holes
FCT250.06030 NEW	250	30	3,2/2,2	60	PH02
FCT250.08030 NEW	250	30	3,2/2,2	80	PH02
FCT300.07230 NEW	300	30	3,2/2,2	72	PH02
FCT300.09630 NEW	300	30	3,2/2,2	96	PH02
FCT350.08430 NEW	350	30	3,5/2,5	84	PH02
FCT350.11230 NEW	350	30	3,5/2,5	112	PH02

Xtra® cut

UNA NUOVA FRONTIERA DEL TAGLIO CON UNA SPECIALE RESINA SINTETICA INSERITA NEI TAGLI DI SILENZIATURA PER UNA MAGGIORE STABILITÀ E RIDUZIONE DELLE VIBRAZIONI
A NEW LEVEL OF CUTTING WITH SPECIAL SYNTHETIC RESIN FILLED IN THE SLOTS TO INCREASE THE STABILITY AND REDUCE VIBRATIONS

- **SILENZIOSITÀ/ LOW NOISE**
- **NO VIBRAZIONI/ NO VIBRATION**
- **MIGLIORE FINITURA/ BETTER FINISHING**
- **MAGGIORE DURATA/ LONGER LIFE**

GRUPPO/SECTION 13

COLTELLI E LIMITATORI DA PROFILARE IN ACCIAIO "SP" BLANK KNIVES AND LIMITERS IN "SP" STEEL

ART. SA

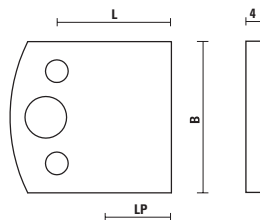

- Possibilità di profilo entro la quota "LP"
- **Venduti a coppie**
- They have to be sharpened within "LP" dimension
- **Sold in pairs**

Articolo/Item	B	L	C	LP	Tipo/Type
SA000X NEW	40	33,5	4	18	Coltello/Knive
SA100X NEW	38	32,5	4	18	Limitatore/Limiter
SA200X NEW	50	34	4	20	Coltello/Knive
SA300X NEW	48	33	4	20	Limitatore/Limiter

DXF SOFTWARE

m. conti

Innovativa implementazione bidirezionale al software del Preset Leader che **permette di selezionare, caricare e comparare un disegno in formato DXF con il profilo dell'utensile per verificarne la corrispondenza ed eventuali scostamenti**. E' inoltre possibile effettuare anche l'operazione inversa, creando cioè un disegno DXF direttamente dal profilo dell'utensile. Una volta creato il disegno DXF necessiterà comunque di essere rielaborato da un operatore attraverso il programma CAD.

The new DXF Software will allow the operator to select, upload and compare a DXF drawing with the tool profile, in order to verify the correspondence and possible differences in the easiest way. Furthermore, it is possible to make the other way around and create the DXF drawing starting from the tool profile. The drawing, however, will need to be revised by an operator with CAD program.

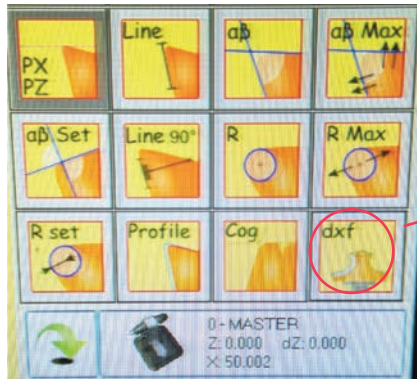

NUOVO Software per Preset LEADER
NEW Preset LEADER Software

Modo d'uso:

1. Caricare il file DXF sulla memoria SSD del PC
2. Selezionare il file e richiamarlo sullo schermo in pochi e semplici click.
3. Trascinare il disegno comparandolo con il profilo dell'utensile per verificarne la corrispondenza.
Il sistema permette di misurare eventuali scostamenti di quota tra il profilo DXF e il profilo dell'utensile con precisione millesimale.

How to use:

1. Upload the DXF drawing on the SSD drive of the PC
2. Select and recall the tool profile in DXF format on the presetting screen with a couple of clicks of the mouse.
3. Once the DXF file is recalled, it can be placed next to the real profile of the cutter to verify the correspondences.
The two profiles can be easily compared and any difference can be measured accurately.

Articolo/Item

DXFSOFTWARE **NEW**

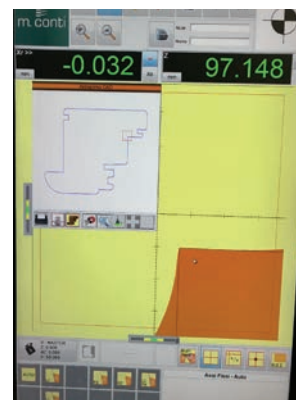
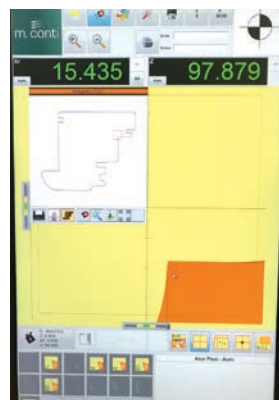
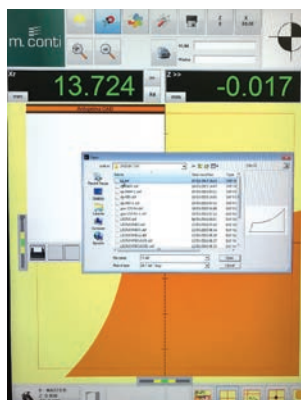

Visit Website



Klein®

S I S T E M I

SISTEMI S.r.l. • 61122 PESARO Via Montanelli, 70

Tel. +39.0721.28950 • Fax +39.0721.283476

www.sistemiklein.com • info@sistemiklein.com